

AE500



General Description

The AE500 is a powerful digital indicator with up to four (4) alarms. The AE500 has various options such as digital communications, analog retransmission output, waterproof, and power supply for LED drive of SP400/SP500. In combination with the input selector SP400/500, maximum 16 points of input can be connected to one AE500. The AE500 matches the physical appearance of the CB series (CB100/400/500/700/900, CB103/403/903) Family of controllers.

Features

- ☆ Bright, easy-to-read LED displays (20mm high)
- ☆ Digital communications
- ☆ Up to 4 alarms
- ☆ Analog retransmission output
- ☆ SP400/500 input selector

Bright, Easy-To-Read LED Displays

Very clear and easy-to-read large LED display (20mm high).



Up to 4 Alarms (Optional)

The AE500 is available for up to 4 alarms. Each alarm is available with hold-function which suppresses alarm activation upon start-up until the measured value has entered the non-alarm range.

Example : Low alarm with hold

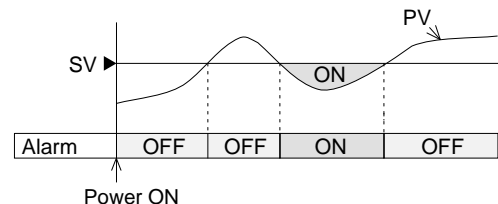

Analog Retransmission Output (Optional)

The measured value can be transmitted by 0-20mA or 4-20mA.

SP400/SP500 Input Selector Unit

The SP400/500 is an input selector unit with 6 inputs (standard) or 5 inputs (transfer type). SP400 is a vertical 1/8 DIN, and SP500 is a horizontal 1/8 DIN type. Maximum 3 units can be connected by using transfer type SP400/500 with 5 inputs.

Digital Communications (Optional)

The AE500 offers an optional RS-485 communications interface for networking to computers, PLCs and SCADA software in your plant. Up to 31 units can be interfaced on one RS-485 communication line.

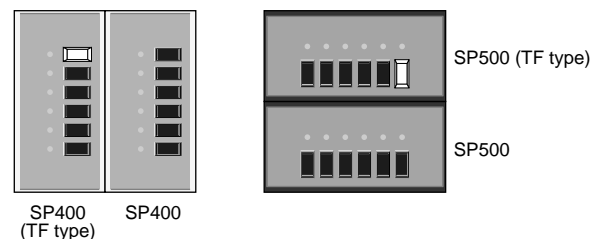
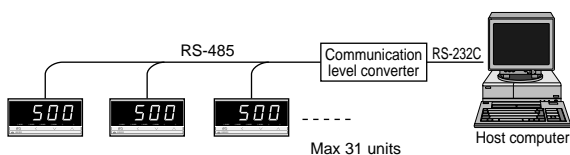

Specifications

Input

Input

- a) Thermocouple : K, J, R, S, B, E, T, N (JIS/IEC), PLII (NBS)
W5Re/W26Re (ASTM), U, L (DIN)
- Influence of external resistance : Approx. $0.2\mu\text{V}/\Omega$
 - Input break action : Up-scale (Alarm output is ON.)
- b) RTD : Pt100 (JIS/IEC), JPt100 (JIS)
- Influence of input lead resistance : Approx. $0.01[\%/\Omega]$ of reading
 - Maximum 10Ω per wire
 - Input break action : Up-scale (Alarm output is ON.)
 - Input short circuit action : Down scale (Alarm output is ON.)
- c) DC voltage : 0 to 5V, 1 to 5V
- Input break action : Down-scale (Alarm output is ON.)
When "0 to 5V" input, value around zero.
- d) DC current : 0 to 20mA, 4 to 20mA
- For DC current input, connect a 250Ω resistor to the input terminals.
 - Input break action : Down-scale (Alarm output is ON.)
When "0 to 20mA" input, value displayed will be around zero.

Sampling time

0.5 sec

PV bias

Temperature input : -1999 (-199.9) to 9999 (999.9)°C[°F]
DC voltage, DC current : - span to +span

Performance

Measuring accuracy

- a) Thermocouple
- ±(0.3% of reading + 1 digit) or ±2°C (4°F) whichever is larger
 - Accuracy is not guaranteed between 0 and 399°C (0 and 749°F) for type R, S and B.
 - Accuracy is not guaranteed between -199.9 and -100.0°C (-199.9 and -158.0°F) for type T and U.
- b) RTD
- ±(0.3% of reading + 1 digit) or ±0.8°C (1.6°F) whichever is larger
- c) DC voltage and DC current
- ±(0.3% of span + 1 digit)

Insulation resistance

More than $20\text{M}\Omega$ (500V DC) between measured terminals and ground
More than $20\text{M}\Omega$ (500V DC) between power terminals and ground

Dielectric strength

1000V AC for one minute between measured terminals and ground
1500V AC for one minute between power terminals and ground

Alarms (Optional)

Alarms

- Number of outputs : 4 points
Alarm type : Process High, Low
- Hold action can be programmed.
- Differential gap : 0 to 100°C or 0.0 to 100.0°C (Temperature input)
0.0 to 10.0% (Voltage, current input)

Alarm Output

Alarm 1, 2 : Relay output, Form A contact 250V AC 1A (resistive load)
Alarm 3, 4 : Relay output, Form A contact 250V AC 3A (resistive load)

Power supply for LED of SP400/SP500 (Optional)

- Output : 12V DC, +1V, -2V
Number of link : Up to 2 with TF and 1 without TF.
(TF : Transfer switch type)

• This option is not available when alarm 4 output is specified.

Communications (Optional)

- a) Communication method : RS-485 (2-wire)
b) Communication speed : 2400, 4800, 9600, 19200 BPS
c) Bit format
- | | |
|--------------|-----------------------------|
| Start bit : | 1 |
| Data bit : | 7 or 8 |
| Parity bit : | Even, odd or without parity |
| Stop bit : | 1 or 2 |
- d) Communication code : ASCII(JIS) 7-bit code
e) Maximum connection : 31 (Address can be set from 0 to 99.)

Analog outputs (Optional)

- a) Number of outputs : 1 point
b) Output signal : 0 to 20 mA DC, 4 to 20 mA DC
(Load resistance : Less than 600Ω)
- c) Output scaling : Available for High and Low limit.
d) Output resolution : More than 10 bits
- This option is not available when alarm 3 is specified.

Waterproof/Dustproof (Optional)

- Waterproof/dustproof protection : IP65
- Waterproof/dustproof protection only effective from the front in panel mounted installations.
 - Waterproof/dustproof protection is not available for close vertical mounting installations.

General specifications

Supply voltage

- a) 85 to 264V AC (Including supply voltage variation)
[Rating : 100 to 240V AC] (50/60Hz common)
b) 21.6 to 26.4V AC (Including supply voltage variation)
[Rating : 24V AC] (50/60Hz common)
c) 21.6 to 26.4V DC (Ripple rate 10% p-p or less) [Rating : 24V DC]

Power consumption

Less than 10VA for standard AC type
Less than 5VA for 24V AC type
Less than 160mA for 24V DC type

Power Failure Effect

Not affected by power failure shorter than 20msec, otherwise reset to the initial state.

Operating environments : 0 to 50°C [32 to 122°F] , 45 to 85% RH

Memory backup : Backed up by non-volatile memory.

Net weight

Approx. 250g

External dimensions (W x H x D)

96 x 48 x 100mm

Compliance with standards

- CE Mark
- UL Recognized
- CSA Certified



Model and Suffix Code

Specifications	Model and Suffix Code											
Model	AE500 □□□ - □ * □ □ □ □ - □ □ / □ / Y											
Input and Range	See Range and Input Code Table □□□□											
Power Supply	24V AC/DC 3 100 to 240V AC 4											
Alarm 1	Not supplied N See Alarm Code Table □											
Alarm 2	Not supplied N See Alarm Code Table □											
Alarm 3 / Analog output	Not supplied N See Alarm Code Table □ 0 to 20mA DC 7 4 to 20mA DC 8											
Alarm 4 / Power supply for LED of SP400/SP500	Not supplied N See Alarm Code Table □ Power supply for LED of SP400/SP500 P											
Digital communications	Not supplied N RS-485 5											
Waterproof/Dustproof	Not supplied N Waterproof/Dustproof protection 1											
Body color	Black A White N											
Instrument version	Version symbol Y											

Range and Input Code Table

Thermocouple

Input	Code	Range
K	K : 01	0 - 200°C
	K : 02	0 - 400°C
	K : 03	0 - 600°C
	K : 04	0 - 800°C
	K : 05	0 - 1000°C
	K : 06	0 - 1200°C
	K : 07	0 - 1372°C
	K : 13	0 - 100°C
	K : 14	0 - 300°C
	K : 20	0 - 500°C
	K : A1	0 - 800°F
	K : A2	0 - 1600°F
	K : A3	0 - 2502°F
	K : A9	20 - 70°F
J	J : 01	0 - 200°C
	J : 02	0 - 400°C
	J : 03	0 - 600°C
	J : 04	0 - 800°C
	J : 05	0 - 1000°C
	J : 06	0 - 1200°C
	J : A1	0 - 800°F
	J : A2	0 - 1600°F
R ¹	R : 01	0 - 1600°C
	R : 02	0 - 1769°C
	R : 04	0 - 1350°C
	R : A1	0 - 3200°F
	R : A2	0 - 3216°F
	S ¹	S : 01
S : 02		0 - 1769°C
S : A1		0 - 3200°F
S : A2		0 - 3216°F
B ¹	B : 01	400 - 1800°C
	B : 02	0 - 1820°C
	B : A1	800 - 3200°F
	B : A2	0 - 3308°F

Input	Code	Range	
E	E : 01	0 - 800°C	
	E : 02	0 - 1000°C	
	E : A1	0 - 1600°F	
	E : A2	0 - 1832°F	
N	N : 01	0 - 1200°C	
	N : 02	0 - 1300°C	
	N : A1	0 - 2300°F	
	N : A2	0 - 2372°F	
	T ²	T : 01	-199.9 - 400.0°C
		T : 02	-199.9 - 100.0°C
T : 03		-100.0 - 200.0°C	
T : 04		0.0 - 350.0°C	
T : A1		-199.9 - 752.0°F	
T : A2		-100.0 - 200.0°F	
W5Re / W26Re	W : 01	0 - 2000°C	
	W : 02	0 - 2320°C	
	W : A1	0 - 4000°F	
	PL II	A : 01	0 - 1300°C
		A : 02	0 - 1390°C
A : 03		0 - 1200°C	
U ²	A : A1	0 - 2400°F	
	A : A2	0 - 2534°F	
	U : 01	-199.9 - 600.0°C	
	U : 02	-199.9 - 100.0°C	
	U : 03	0.0 - 400.0°C	
	U : A1	-199.9 - 999.9°F	
L	U : A2	-100.0 - 200.0°F	
	U : A3	0.0 - 999.9°F	
	L : 01	0 - 400°C	
L : 02	0 - 800°C		
L : A1	0 - 800°F		
L : A2	0 - 1600°F		

RTD

Input	Code	Range
Pt100	D : 01	-199.9 - 649.0°C
	D : 02	-199.9 - 200.0°C
	D : 03	-100.0 - 50.0°C
	D : 04	-100.0 - 100.0°C
	D : 05	-100.0 - 200.0°C
	D : 06	0.0 - 50.0°C
	D : 07	0.0 - 100.0°C
	D : 08	0.0 - 200.0°C
	D : 09	0.0 - 300.0°C
	D : 10	0.0 - 500.0°C
	D : A1	-199.9 - 999.9°F
	D : A2	-199.9 - 400.0°F
	D : A3	-199.9 - 200.0°F
	D : A4	-199.9 - 100.0°F
JPt100	D : A5	-100.0 - 300.0°F
	D : A6	0.0 - 100.0°F
	D : A7	0.0 - 200.0°F
	D : A8	0.0 - 400.0°F
	D : A9	0.0 - 500.0°F
	P : 01	-199.9 - 649.0°C
	P : 02	-199.9 - 200.0°C
	P : 03	-100.0 - 50.0°C
	P : 04	-100.0 - 100.0°C
	P : 05	-100.0 - 200.0°C
P : 06	0.0 - 50.0°C	
P : 07	0.0 - 100.0°C	
P : 08	0.0 - 200.0°C	
P : 09	0.0 - 300.0°C	
P : 10	0.0 - 500.0°C	

Voltage and Current ³

Input	Code	Range
0 - 5V DC	4 : 01	0.0 - 100.0
1 - 5V DC	6 : 01	0.0 - 100.0
0 - 20mA DC	7 : 01	0.0 - 100.0
4 - 20mA DC	8 : 01	0.0 - 100.0

- ¹ Type R, S and B input : Accuracy is not guaranteed between 0 and 399°C (0 and 749°F)
² Type T and U input : Accuracy is not guaranteed between -199.9 and -100.0°C (-199.9 and -158.0°F)
³ DC current input : A 250 Ω resistor is externally connected to the input terminals.

Alarm Code Table

Code	Type
H	Process High
J	Process Low
K	Process High with hold
L	Process Low with hold

Accessory

Shunt resistor for DC current input
KD100-55

SP400/SP500 input selector unit

- Input type : Thermocouple K, J, E, T, R, S, B, N (JIS/IEC), U, L (DIN)
 RTD Pt100 (JIS/IEC), JPt100 (JIS)
 Voltage, current inputs 0 to 5V DC, 1 to 5V DC, 0 to 20mA DC, 4 to 20mA DC
- Number of inputs : 6 points
- Link method : 5 points : Transfer switch type
 Serial connecting transfer switch type
 • Maximum 3 units with TF type and 1 unit non-TF type
- Display : LED lights by the power supply from the indicator (AE500 option : 12V DC).
- Life of switch : 30 thousand operations (at 70mm/sec.)
 Contact resistance : 15mΩ (initially), and less than 40mΩ after 30 thousand operations.
 Switching timing : Non-shooting.
 Switching force : Less than 800g, within ± 30% of initial value after 30 thousand operations.

SP400/SP500 Model and Suffix Code

Specifications	Model and Suffix Code											
Model	SP400 (Vertical type) SP500 (Horizontal type)											
Input	Thermocouple : K K Thermocouple : J J Thermocouple : R R Thermocouple : S S Thermocouple : B B Thermocouple : E E Thermocouple : T T Thermocouple : N N Thermocouple : U U Thermocouple : L L RTD input D Voltage/Current DC input V											
Transfer switch	Not supplied N With transfer switch T											
Body color	Black A White N											

Panel Mounting Type Indicator AE500



External Dimensions and Rear Terminals

AE500

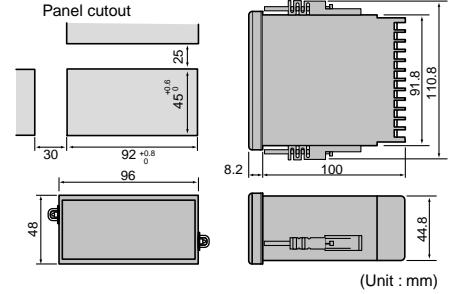
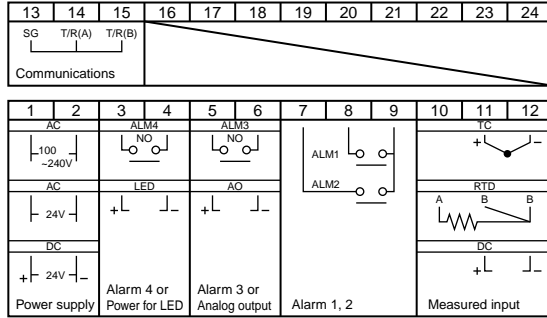
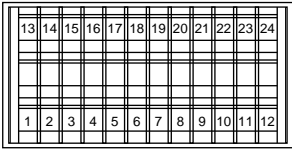

SP400 / SP500

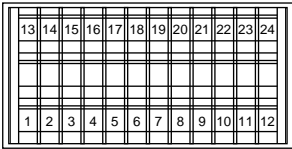

SP500

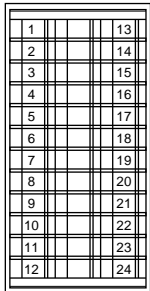
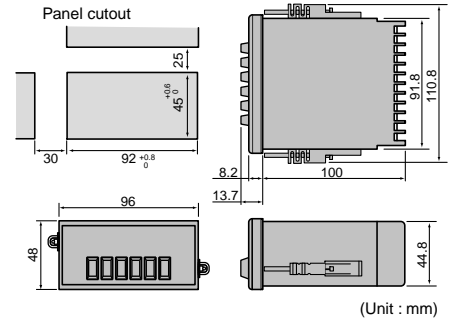
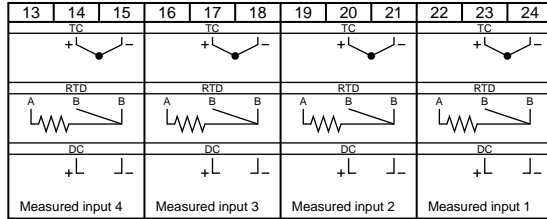

SP400

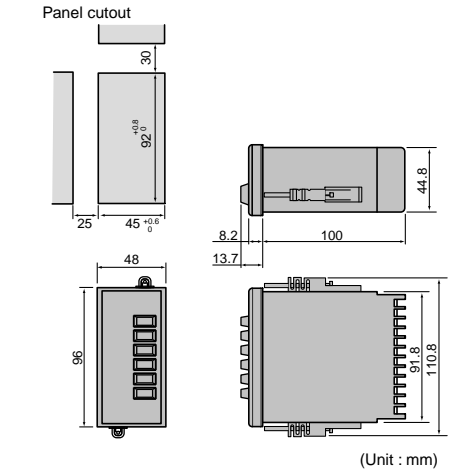
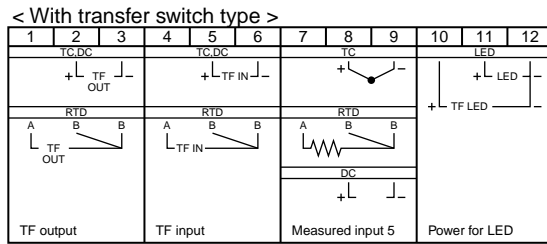
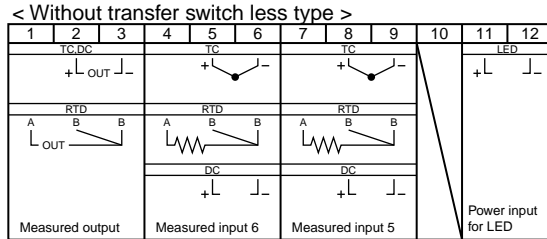

Panel cutout for closely contacted mounting

AE500, SP500

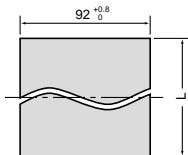

SP400

