



SB1



General Description

SB1 is a 1 channel temperature controller with Built-in SSR (Solid state relay) designed for flexible heating solutions such as heat trace of pipelines (by controlling Jacket heater etc). Instrument can be wired directly to heaters.

Features

- ☆ Direct Connection to Load (with Built-in SSR)
- ☆ Can be installed in a small space or into a pipe
- ☆ Easy Connection (with a complete connector)
- ☆ Power Saving by SB Link
- ☆ Load Power Shutoff Function and Fuse

Capable of direct connection to the load

Temperature control can be easily assembled and started by connecting a heater line and temperature sensors to the SB1. Wiring is handled with connectors to reduce wiring time.

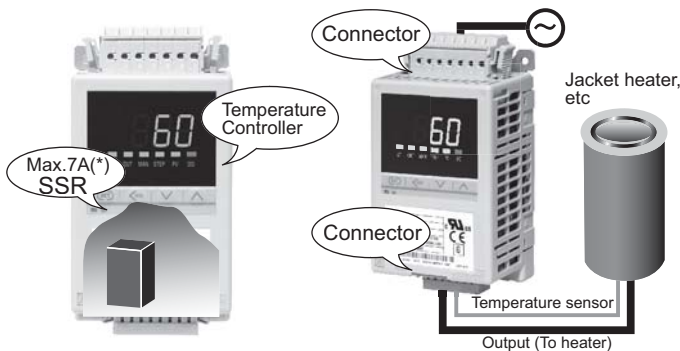

(*) Permissible load capacity may be less than 7A depending on the ambient temperature of the installation location.

Safety design < Load Power Shutoff Function + Fuse >

This function disconnects internal load power with an internal relay.

A fuse is incorporated inside the SB1 to protect the instrument from a load short-circuit.

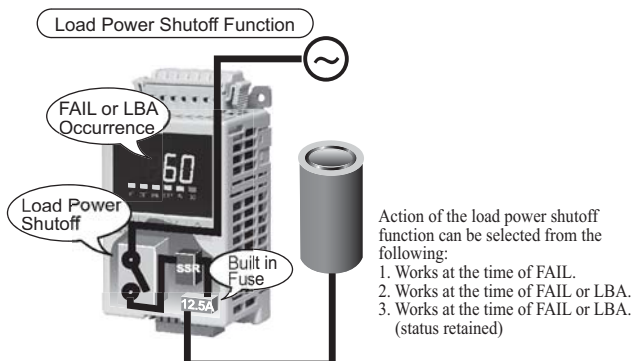

* Internal fuse must be replaced by an authorized personnel.

Can be installed in a small space or onto a pipe

The SB1 can be supplied with pipe wrapping type, pipe hanging type, DIN-rail mounting type, or panel mounting type. Proper mounting can be attained according to the pipe configuration.

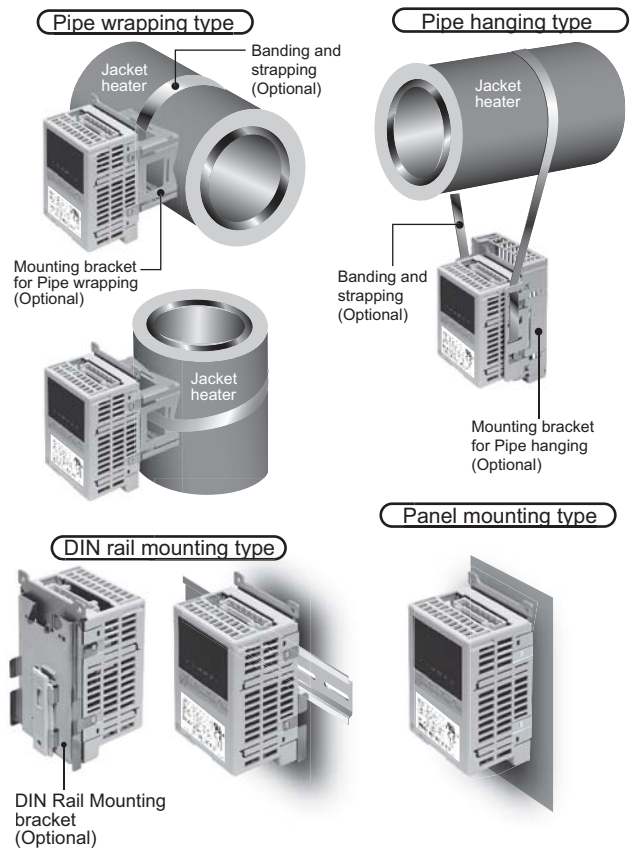

Temperature Controller with Built-in SSR SB1

Features

Setup and Data Monitoring

Data can be viewed on site by using the display and operation keys or controlled remotely via loader communication port.

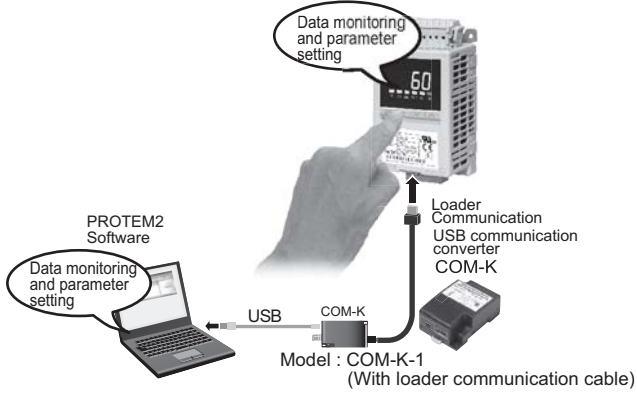

Power saving by SB Link

Peak current suppression (SB Link)

When SB1 controllers are divided into groups (max. 4 pcs per group) with the output limiter, the controllers in the same group will not turn on simultaneously.

Saves energy by limiting the control output around the normal load factor.

* SB Link cannot be used simultaneously with a host communication.

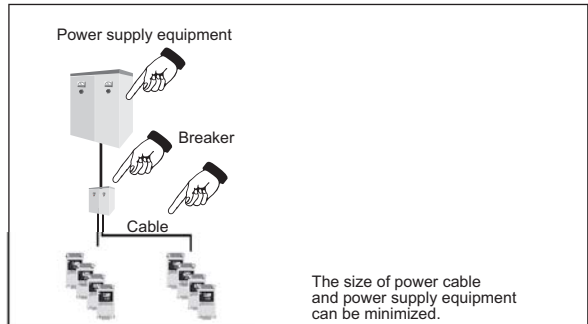
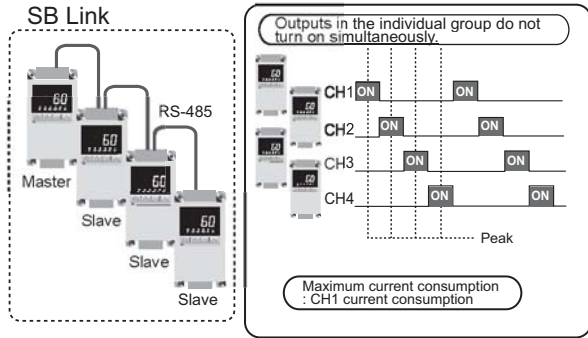

Installation and wiring example

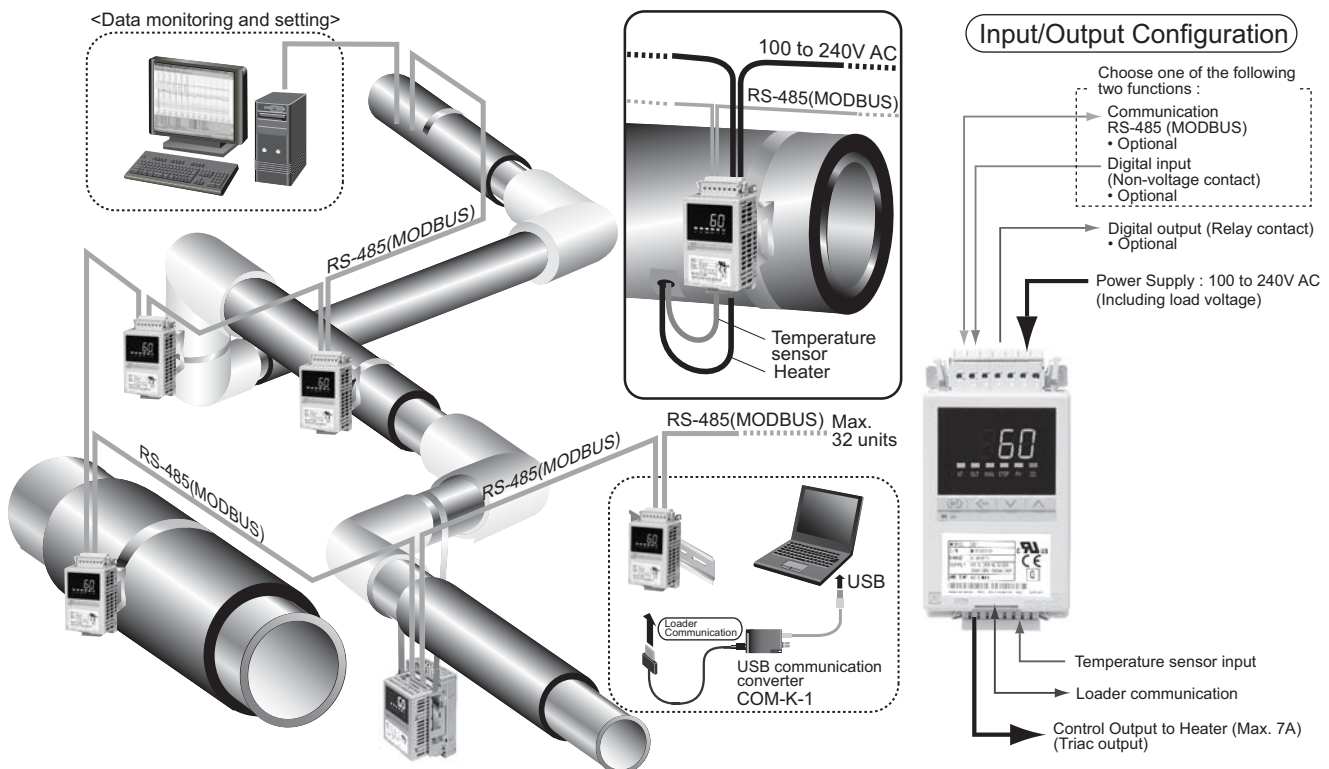



Specifications

Input

Input

- Thermocouple : K, J, (JIS/IEC) : 0 to 800°C, 0 to 999°F
- Influence of external resistance : Approx. 0.25μV/Ω
 - Input break action : Up-scale
- RTD : Pt100 (JIS/IEC) : 0 to 400°C, 0 to 800°F
- 1/0.1°C(°F) display can be selectable on only communication data
 - Influence of input lead resistance : Approx. 0.02[%/Ω] of reading
 - Maximum 10Ω per wire
 - Input break action : Up-scale
 - Universal input

Sampling Time

0.25 sec

Input Digital Filter

0 to 100 sec (OFF when 0 is set.)

PV Bias

-199 to +999°C(°F)

Performance

Measuring Accuracy

- a) Thermocouple
- 0°C or more, Less than 500°C (932°F) : ±(1.5°C [2.7°F] + 1 digit)
 - 500°C (932°F) or more : ±(0.3% of Reading + 1 digit)
- b) RTD
- 0°C or more, Less than 200°C (392°F) : ±(0.6°C [1.1°F] + 1 digit)
 - More than 200°C (392°F) : ±(0.3% of Reading + 1 digit)
- Cold-junction temperature compensation error :
 - ±1°C [1.8°F] (23°C±2°C [73°F±3.6°F])
 - ±2°C [3.6°F] (-10 to 60°C [14 to 140°F])

Insulation Resistance

- More than 20MΩ (500V DC) between measured terminals and ground (PE terminal)
- More than 20MΩ (500V DC) between power terminals and ground (PE terminal)

Dielectric Strength

- 1000V AC for one minute between measured terminals and ground (PE terminal)
- 1500V AC for one minute between power terminals and ground (PE terminal)

Setting

SV limiter

Scaling low to scaling high (High/Low individual setting)

Ramp-to-setpoint

1 to span per Time
(Time : 1 minute/1 hour (Selectable) Up/Down individual setting)

SV step function

Number of SV : 2 points (SV1/SV2)
SV selecting method : Front key, Communication,
Digital input (External contact input)

Setting data lock

Lock level : 1 to 10 level (0 : No lock)

Control

Control Method

- PID control (With autotuning)
- P, PI, PD, ON/OFF control selectable
- Direct action/Reverse action is selectable

Startup tuning

- The condition to activate Startup Tuning is selectable among a) to g)
- At power-on and stop-to-run, one-time tuning
 - At SV change, one-time tuning
 - At power-on, stop-to-run and SV change, one-time tuning
 - At every power-on and stop-to-run
 - At every SV change
 - At every power-on, stop-to-run and SV change
 - Function off

Fine tuning

Setting range : -3 to +3 (6 levels, OFF when set to 0.)
-3 to -1 : Faster response
1 to 3 : Slower response
OFF : Function OFF

Major Setting Range

- Set value : Same as input range.
Proportional band : 0 to input span (°C,°F)
- Differential gap at ON/OFF control : 0 to 100 (°C,°F)
- Integral time : 1 to 999sec (P + D action when I = 0)
Derivative time : 1 to 999sec (P + I action when D = 0)
Cool-side proportional band : 1 to 1000% of heat side proportional band
Anti-Reset Windup(ARW) : 1 to 100% of heat side proportional band (Integral action is OFF when ARW = 0)
- Derivative time action select : 0 : PV derivative, 1 : Deviation derivative
Output limiter : -5.0 to +105.0% (High/Low individual setting)
- Proportional cycle time : 1 to 100 sec
Manual output : Output limiter low to Output limiter high
- Auto/Manual transfer action selection With bumpless/Without bumpless

Control output

- Triac output :
- Output method: AC output (Zero-cross method)
 - Allowable load current: 7 A (Ambient temperature 40°C or less)
 - Set the surface temperature to the following degree if the allowable load current exceeds 3A:
 - Front side: 80°C or less
 - Metal at the back side: 100°C or less
 - Load voltage : 100 to 240 V AC (Same as the power supply voltage)
 - Minimum load current: 50 mA
 - ON voltage : 1.5 V or less (at maximum load current)

Event (Alarm) Output (Optional)

Number of Event

Up to 2 points

Event

- Type :
- Deviation High, Low, High/Low*1, Band,
 - Process High, Low
 - Set value High, Low
 - Control Loop Break Alarm (LBA)
 - Output of the communication monitoring result,
 - FAIL, RUN status monitor
- *1: Two types of alarm settings are field-selectable.
1. Independent high and low settings.
 2. Common high/low setting (Factory setting, unless specified in alarm code when ordering)

Setting range

- Deviation : -199 to + (input span)
Differential gap : 0 to input span
- Process, Set value : Same as input range
Differential gap : 0 to input span
- Control loop break alarm (LBA)
: LBA time : 0 to 999 sec. (OFF by setting zero)
LBA deadband : 0 to input span

Output

- Number of Event : 1 point
Output method : Relay contact output, Form a contact,
250V AC 1A, 30V DC 0.5A (Resistive load)

Other Functions

- Hold/Re-hold action
 - Hold action is activated at power-on and stop-to-run.
 - Re-hold action is activated at power-on, stop-to-run, and the control set value change.
- Energized/de-energized action is configurable.
- Delay timer : 0 to 600 sec
- Interlock (latch) function is configurable.
- Load Power Shutoff Function

The relay for Load power shutoff opens at the occurrence of instrument abnormality (FAIL) or Control loop break alarm (LBA). (Shut off the internal load power line. [L side of the power])

[Selectable action]

 - Relay for Load power shutoff opens at FAIL (Restores when FAIL is resolved.)
 - Relay for Load power shutoff opens at FAIL or LBA (FAIL state or LBA state remains.)
 - Relay for Load power shutoff opens at FAIL or LBA (Returns to the normal state when FAIL state or LBA state recovers.)

Digital Input (Optional)

• Not available with Communication

Number of Sub Output

1 point

Input method

Non-voltage contact output

Function

- SV1/SV2 selection, STOP/RUN, Auto/Manual, Alarm interlock reset,
- Selectable

Temperature Controller with Built-in SSR SB1



Specifications

Communications (Optional)

• Not available with Digital Input (DI)

Communication method :	RS-485
Communication speed :	2400, 4800, 9600, 19200, BPS
Protocol :	ANSI X3.28(1976) 2.5 A4 MODBUS-RTU
Bit format	
Start bit :	1
Data bit :	7 or 8 •For MODBUS 8 bit only
Parity bit :	Without, Odd or Even
Stop bit :	1 or 2
Maximum connection :	31 units
Terminating resistor :	External installation is necessary (120Ω 1/2W)
Buffer mode :	Correspond (Mode in which writing to EEPROM is not performed for setting changes)

● Temperature characteristics of load current

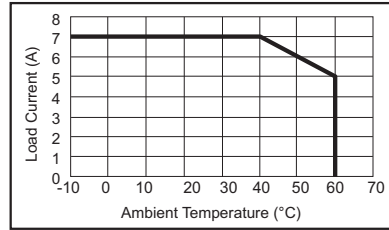

CAUTION

Temperature of the Installation position (surface of a jacket heater) : -10 to +100°C.

Inter-controller Communication (Optional) (SB Link)

• Not available with Digital Input (DI)

Function :	Peak current suppression function When a group of controllers (up to 4 units) is connected by SB link, use the Peak current suppression function by setting Output limiter high to prevent all outputs from turning ON at the same time.
Communication method :	RS-485
Communication speed :	19200BPS
Protocol :	MODBUS-RTU
Bit format	
Start bit :	1, Data bit: 8, Parity bit: None, Stop bit: 1
Maximum connection :	4 controllers (Address setting range: 0 to 3 *) * Address No. 0 is for Master controller.

Loader Communication

Communication speed :	9600BPS
Protocol :	ANSI X3.28 sub-category 2.5A4 (RKC standard)
Bit format	
Start bit :	1, Data bit: 8, Parity bit: None, Stop bit: 1
Connection method :	COM-K loader cable (equivalent to W-BV-01-1500)

General Specifications

Power Failure Effect

A power failure of 10m sec or less will not affect the control action.

Memory Backup : Backed up by non-volatile memory

- Data retaining period : Approx. 10 years
- Number of writing : Approx. 1,000,000 times.
(Depending on storage and operating conditions.)

Supply Voltage

90 to 264V AC (Including supply voltage variation)
[Rating : 100 to 240V AC] (50/60Hz selectable)

Power Consumption

When a load is disconnected : 4.0 VA max. (at 100 V AC)
6.7 VA max. (at 240 V AC)
When a load is connected [Ambient temperature: 40°C] :
705 VA max. (When connecting a load equivalent to 7A at 100 V AC)
1690 VA max. (When connecting a load equivalent to 7A at 240 V AC)

Rush Current

Less than 13.3A (240V), Less than 5.6A (100V)

Operating Environments :

-10 to 60°C [14 to 140°F]
5 to 95% RH (Non condensing)
Absolute humidity : MAX. W.C 29.3g/m³ dry
air at 101.3kPa.

Net Weight

Approx. 130g

Model and Suffix Code

Specifications	Model and Suffix Code		Hardware coding only											Quick start code	
	SB1		①	②	③	④	⑤	⑥	⑦	⑧	⑨	⑩	⑪		
① Control Method	PID control with AT (Reverse action)		F												
② Input and range	See Input range Code Table														
③ Control output (OUT)	Triac output				T										
④ Power Supply	100 to 240V AC					4									
⑤ Digital output (DO)	Not supplied Digital output : 1 point							N							
⑥ Communication/ Digital input (DI)	Not supplied														
	Digital input : 1 point							D							
	RS-485 (ANSI/RKC standard protocol) RS-485 (MODBUS protocol)							5							
⑦ Mounting method	Without mounting bracket (Panel mounting)														
	With mounting bracket (Sold separately)									N					
⑧ Quick start code	No quick start code (Default setting)														
	Specify quick start code (Event, Digital output type)									1					
⑨ Event 1 (Alarm 1) type	No quick start code (Default setting) See Alarm Code Table													No Code	
⑩ Event 2 (Alarm 2) type	No quick start code (Default setting) See Alarm Code Table													No Code	
⑪ Digital output assignment	No quick start code (Default setting)													No Code	
	Event 1													1	
	Event 2													2	
	Logical OR of Event 1 and Event 2 Logical AND of Event 1 and Event 2													3 4	

Input range Code Table

(Universal input)

Thermocouple Input

Input	Code	Range
K	K04	0 to 800°C
	KB1	0 to 999°F
J	J04	0 to 800°C
	JA8	0 to 999°F

RTD Input

Input	Code	Range
Pt100	D17	0 to 400°C
	DB4	0 to 800°F

• 1/0.1°C(°F) display can be selectable on only communication data.



Event Code Table

(Programmable)



Event Type	Code	Event Type	Code	Event Type	Code
No event	N	Process High with Hold	K	Deviation High/Low with Alarm Hold (Individual high and low settings)	Y
Deviation High	A	Process Low with Hold	L	Deviation High/Low with Alarm Re-Hold (Individual high and low settings)	Z
Deviation Low	B	Deviation High with Alarm Re-hold	Q	Loop break alarm	2
Deviation High/Low (Common high/low setting)	C	Deviation Low with Alarm Re-hold	R	FAIL	3
Band (Common high/low setting)	D	Deviation High/Low with Re-Hold (Common high/low setting)	T	RUN status	4
Deviation High with Hold	E	Band (Individual high and low settings)	U	Output of the communication monitoring result	5
Deviation Low with Hold	F	Set value High	V		
Deviation High/Low with Hold (Common high/low setting)	G	Set value Low	W		
Process High	H	Deviation High/Low (Individual high and low settings)	X		
Process Low	J				

Mounting type Accessories



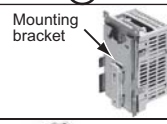

Panel mounting Type

SB1/Accessory	Model Code
SB1	SB1F □□□-T-4 *□□(N)□-□□□
Connector (upper-side)	SB1P-C02 
Connector (lower-side)	SB1P-C01 





DIN rail mounting Type

SB1/Accessory	Model Code
SB1	SB1F □□□-T-4 *□□(1)□ □□□
DIN rail mounting bracket	SB1P-M03 
Connector (upper-side)	SB1P-C02 
Connector (lower-side)	SB1P-C01 

Pipe hanging Type

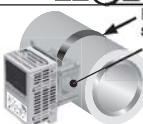
SB1/Accessory	Model Code
SB1	SB1F □□□-T-4 *□□(1)□ □□□
Mounting bracket for Pipe hanging	SB1P-M02 
Banding and strapping	SB1P-B02 
Connector (upper-side)	SB1P-C02 
Connector (lower-side)	SB1P-C01 

Pipe wrapping Type

SB1/Accessory	Model Code
SB1	SB1F □□□-T-4 *□□(1)□ □□□
Mounting bracket for Pipe wrapping	SB1P-M01 
Banding and strapping	SB1P-B01 
Connector (upper-side)	SB1P-C02 
Connector (lower-side)	SB1P-C01 

Temperature Controller with Built-in SSR SB1

Accessories (Sold Separately)

● **Mounting bracket** • Mounting brackets are not necessary when using panel mounting type.

DIN rail mounting Type



DIN rail mounting bracket
SB1P-M03

Pipe hanging Type

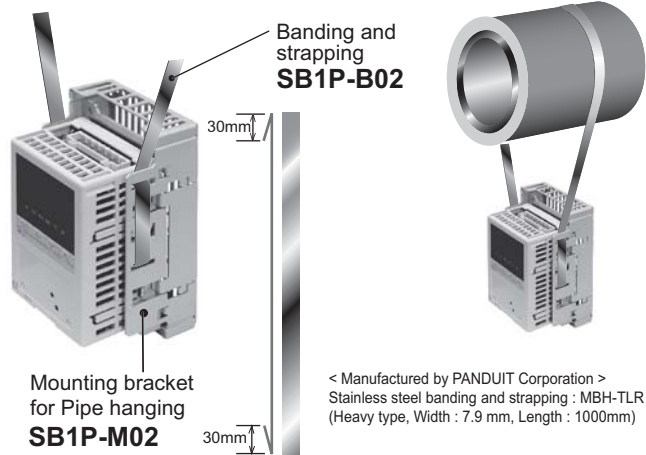

Mounting bracket for Pipe hanging
SB1P-M02

Banding and strapping
SB1P-B02

< Manufactured by PANDUIT Corporation >
Stainless steel banding and strapping : MBH-TLR
(Heavy type, Width : 7.9 mm, Length : 1000mm)

Pipe wrapping Type

Mounting bracket for Pipe wrapping
SB1P-M01

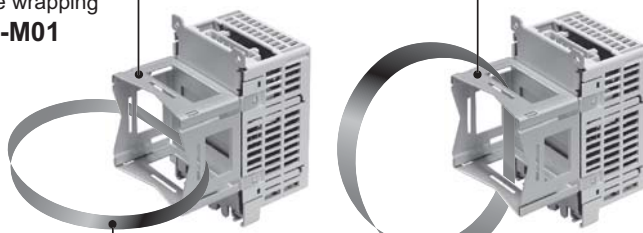

Banding and strapping
SB1P-B01



< Manufactured by PANDUIT Corporation >
Stainless steel banding and strapping : MLT6EH-LP
(Extra heavy Width : 12.7 mm, Length : 594mm)

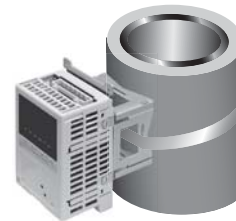
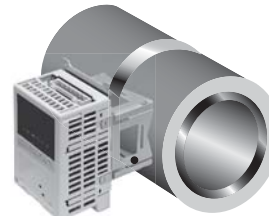

● Connector and Tool for cable wiring



Power supply/
Event input/output/
Communication
connector
SB1P-C02
• Manufactured by
WAGO Corporation:
721-2107/037-000



Measured input/Control
output connector
SB1P-C01
• Manufactured by
WAGO Corporation:
734-108/037-000

Wiring tool

Tool for SB1P-C02
SB1P-C13

• Manufactured by
WAGO Corporation:
210-720
Partially isolated
shaft Type 2



Tool for SB1P-C01
SB1P-C11

• Manufactured by
WAGO Corporation:
210-719
Partially Isolated
shaft Type 1



or

SB1P-C12

• Manufactured by
WAGO Corporation:
734-230
Push button for
connectors
(Connector operating
lever)



• A small screwdriver can be used for wiring.

● USB communication converter (Loader Communication)



Model Code : USB communication converter (COM-K)

Specifications	Model and Suffix code	
	COM - K -	<input type="checkbox"/>
Loader communication cable	Without loader communication cable	N
	With loader communication cable	1

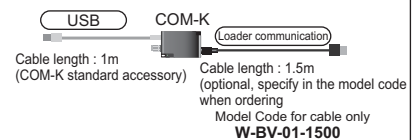

External Dimensions

Unit : mm

Panel mounting type

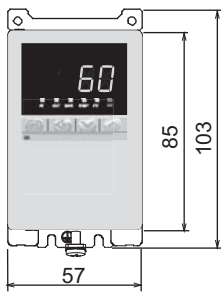

(Panel mounting hole dimensions)

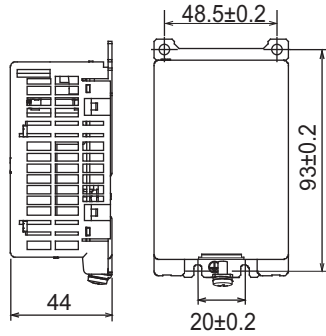

Recommended screw size : M3 size
[Nominal length (L): 6 mm or more]

DIN rail mounting type

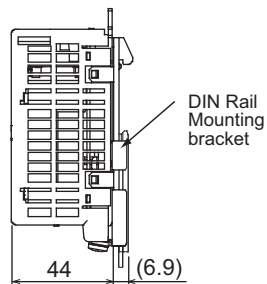
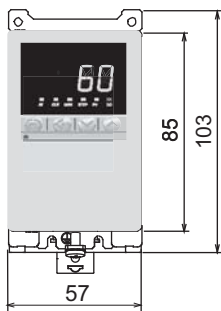

DIN Rail
Mounting
bracket

Pipe hanging type

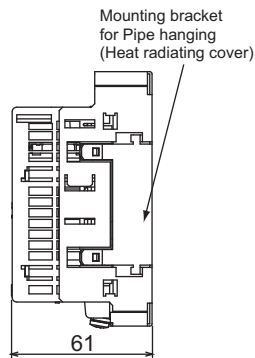
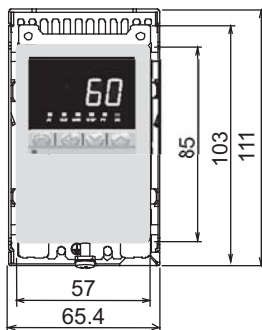

Mounting bracket
for Pipe hanging
(Heat radiating cover)

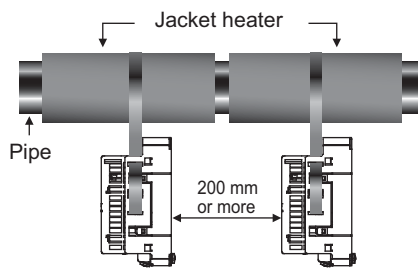

For pipe hanging type, allow sufficient space
(200 mm or more) between the instruments
for heat dissipation.



Pipe wrapping type

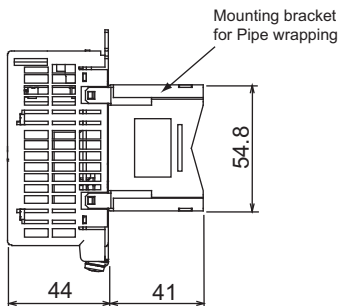
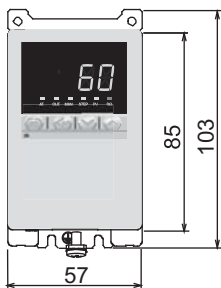

Mounting bracket
for Pipe wrapping

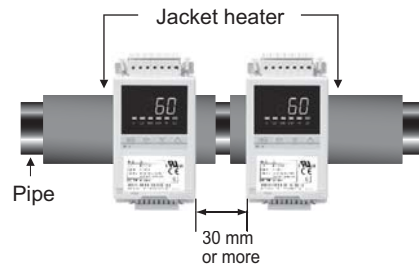

Recommended pipe size
(when a jacket heater is mounted)

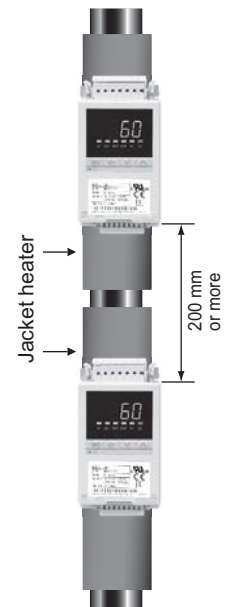
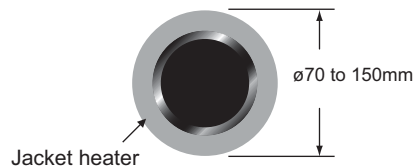

Temperature Controller with Built-in SSR SB1

Connector Configuration

(Caution) Maximum allowable current (power supply part) is 15 A.

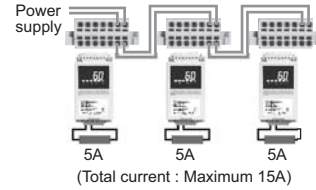
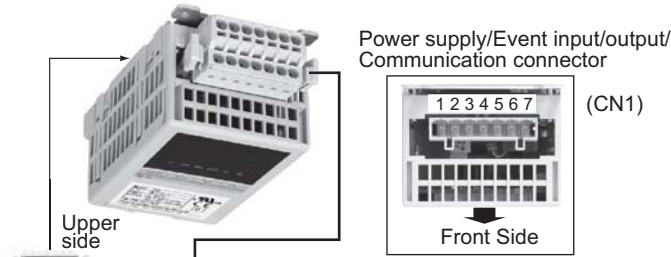

Power supply/Event input/output/ Communication connector (CN1)

Upper side view and Front Side view of the connector (CN1) showing pins 1A-7A and 1B-7B.

Pin No.	1A	2A	3A	4A	5A	6A	7A
	1B	2B	3B	4B	5B	6B	7B
Description	SG T/R(A) T/R(B) RS-485 Communication (Option)		NO Relay contact		L N 100 to 240V AC (Note)		Power supply
	DI Non-Voltage contact		Digital output (DO) (Option)		Digital input (DI) (Option)		

Connector (Sold Separately)
Model Code : SB1P-C02

- Manufactured by WAGO Corporation: 721-2107/037-000
- Recommended cable: Compatible cable diameter : 12 AWG (2.5 mm²) Stripping length: 9 to 10 mm
- The pins of the same number at line A and line B of the Plug are connected internally.
- Communication and Digital input (Event input) cannot be selected at the same time.

Wiring tool (Sold Separately)
Model Code : SB1P-C13

- Manufactured by WAGO Corporation: 210-720 Partially isolated shaft Type 2
- A small screwdriver can be used for wiring.

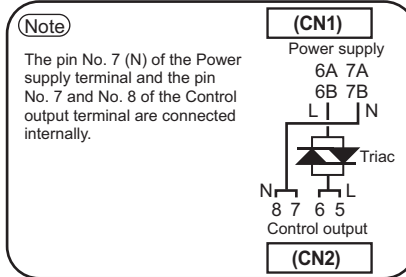
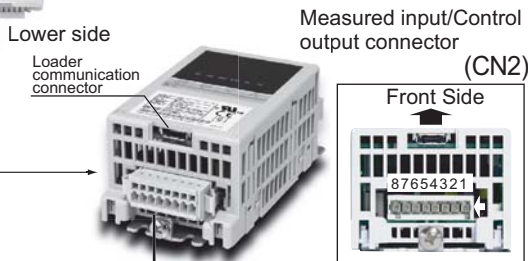

Measured input/Control output connector (CN2)

Front Side view of the connector (CN2) showing pins 8 through 1.

Pin No.	8	7	6	5	4	3	2	1
Description	N Triac AC output Heater				(1) + B B A (2) w			
	Control output (OUT) SSR (Triac)				Measured input (1) Thermocouple (2) RTD			

Connector (Sold Separately)
Model Code : SB1P-C01

- Manufactured by WAGO Corporation: 734-108/037-000
- Recommended cable: Compatible cable diameter : 14 AWG (1.5 mm²) Stripping length: 6 to 7mm
- The pin No. 5 and No.6, the pin No. 7 and No. 8 are connected internally.

Wiring tool (Sold Separately)
Model Code : SB1P-C11

Wiring tool (Sold Separately)
Model Code : SB1P-C12

- Manufactured by WAGO Corporation: 210-719 Partially Isolated shaft Type 1
- A small screwdriver can be used for wiring.
- Manufactured by WAGO Corporation: 734-230 Push button for connectors (Connector operating lever)