



# SRZ



## General Description

The SRZ is a DIN rail mounted module type temperature controller. 4 or 2 loop control can be performed with a single compact module. Module can have 4 CT (Current transformer) inputs. A maximum of 16 temperature control modules can be connected for 64-loop control. Power supply and communication lines are via a connector on the side, no wiring required.

## Features

- ☆ 4 loop controller packed in one compact module
- ☆ Multi-zone space-saving and less wiring
- ☆ Heat/Cool action
- ☆ Heater/Loop break alarms
- ☆ DIN rail mounting

## Space-Saving and Less Wiring

4CH temperature controller packed in one compact module. Separated installation by control zones is possible. Wiring to sensors and output devices is minimized. Modules can be installed separately inside a control panel or a machine to reduce the physical size of the housing.

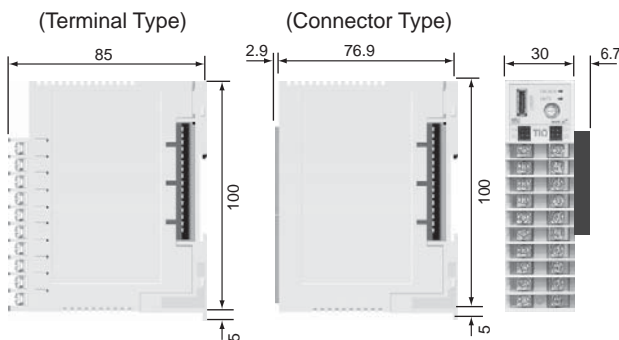

## Module Configuration

### Input/Output Configuration

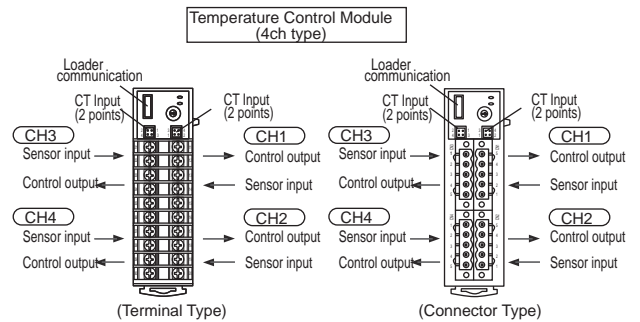

### Digital Input/Output Module

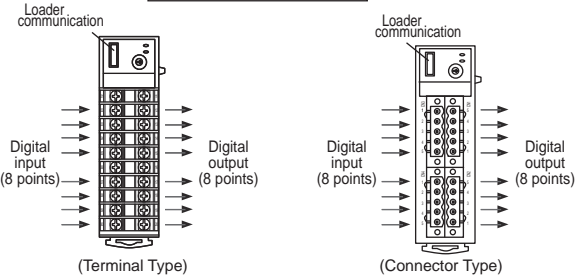

### CT Input Module

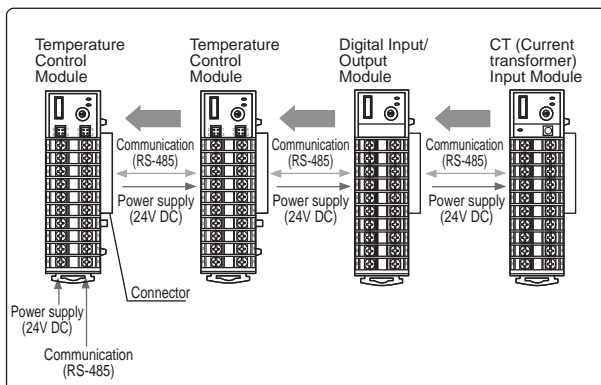
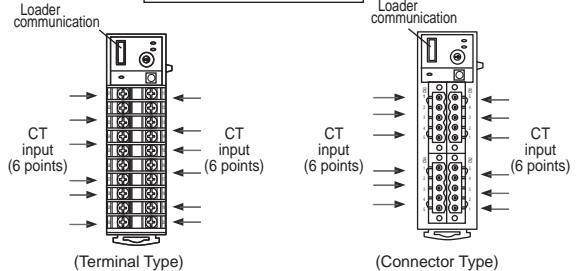

## Features

### Flexible temperature control system configuration

MODBUS/ANSI RKC standard protocol communication

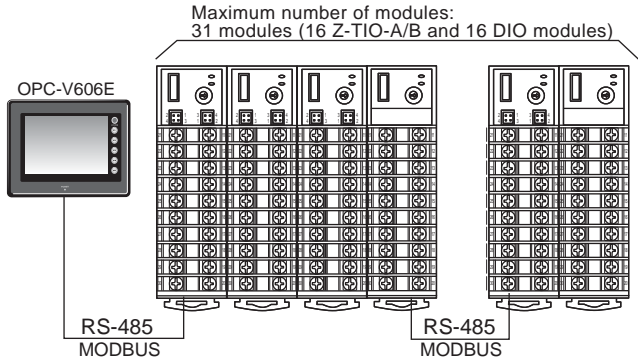

PLC special protocol

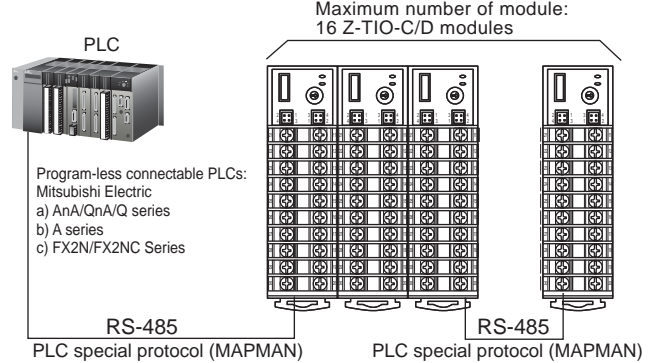

Z-COM module can manage data from connected control modules via high-speed bus connection. MAPMAN program-less connection to PLC is also available.

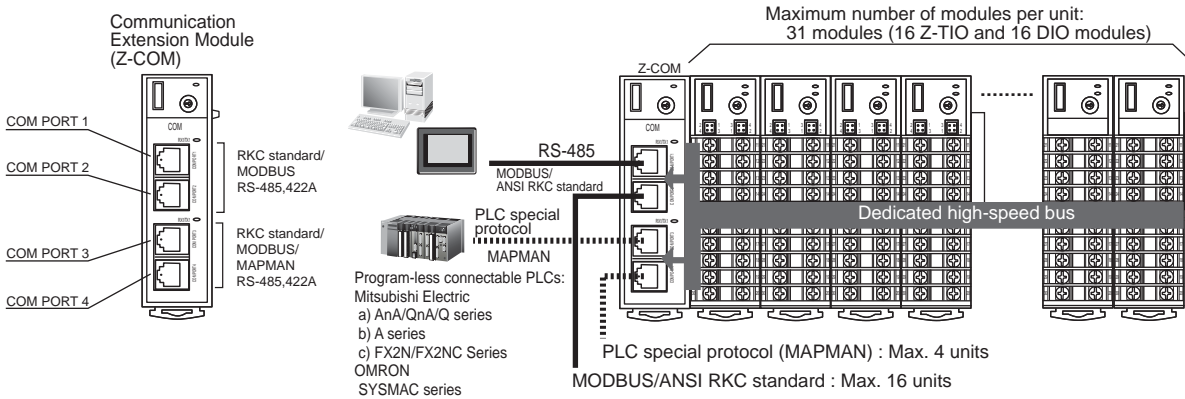

### Temperature uniformity at ramp-up (Auto-temperature rise function)

The Auto-temperature rise function controls the rate of temperature rise uniformly across all the channels in a specified group. The SRZ system has the ability to have multiple groups within each system. This uniform controlled temperature rise will suppress local overheating and mechanical distortion in the tools, contributing to higher product quality.

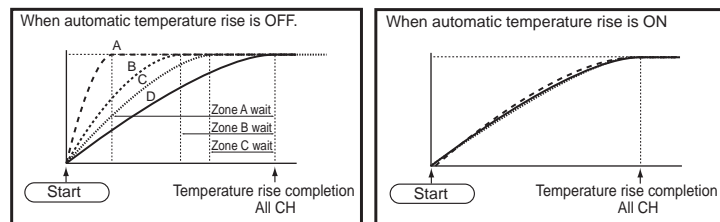

### Peak current suppression

Peak current suppression minimizes the capacity of electrical materials such as power supply equipments, switchboards, power lines, and breakers since this function makes the timing of control output on each channel separate so that the current consumption of the channel with maximum heater capacity is detected as maximum current consumption.

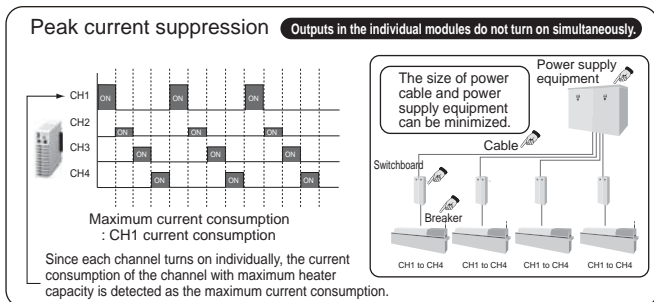
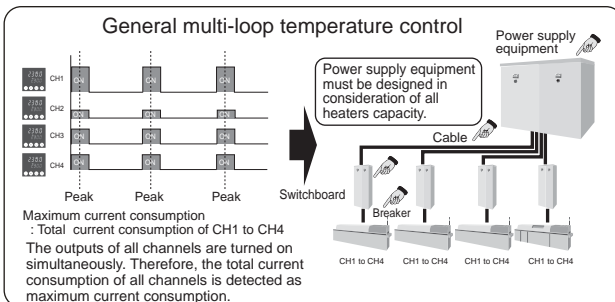

## Features

### External disturbance suppression with autotuning (EDS)

EDS with autotuning calculates optimum settings to suppress control disturbance caused by external factors. The function is activated by a DI signal to adjust control output (feed-forward) to compensate for the disturbance.

It is suitable for an application in which external disturbance can be predicted, such as wafer-in/out in semiconductor manufacturing equipment, and during injection in injection molding machine.

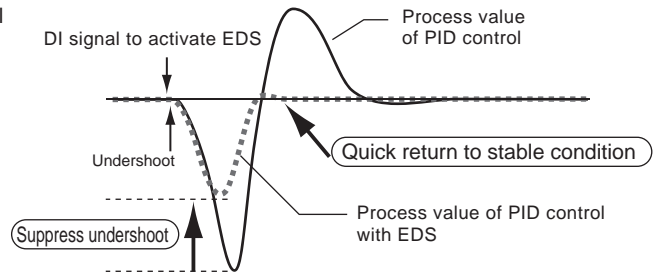

### Automatic SV setting on heater break alarm and heater over current alarm

Set values of Heater break alarm (HBA) and heater over current alarm are automatically set by pressing a front-mounted push button when a heater is on. This function is also available for three-phase heater break alarm.

- HBA function of Z-CT module is designed only for time proportional control (On/Off output). Phase control (continuous output) is not available.
- The CT input monitor value indicates the effective value when the heater break alarm function is enabled and output is 100% (heater ON) or 0% (heater OFF.)

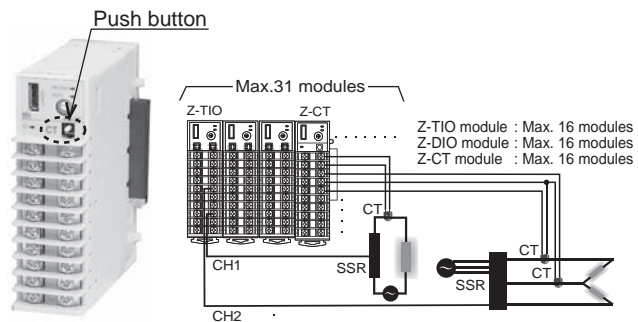

### Multi-loop profile control (Output ratio distribution function)

This function enables one master loop to distribute its output value to multiple outputs of Z-DIO modules. Bias and ratio can be set for each output independently.

A maximum of 187 distribution outputs from one control loop is possible when Z-DIOs and Z-TIOs are used for output ratio distribution.

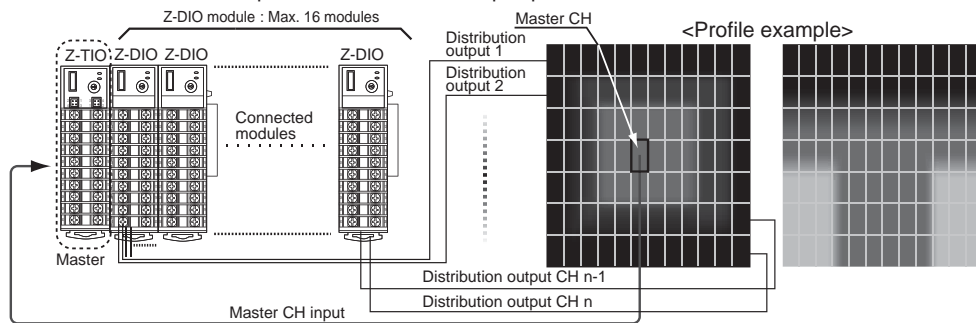

- Output ratio distribution function works via back plane connected modules.
- Distribution output from DIO module becomes open collector output or relay contact output.

### Communication with a PC via USB port (Loader communication)

The SRZ module has a standard loader port on the front panel to connect to a PC USB port via COM-K2 (USB communication converter). Using Win-UCI software on the PC, parameter settings can be easily saved on the PC in CSV format, and the same parameter settings are easily copied to other SRZ modules.

- The Loader port is only for parameter setup

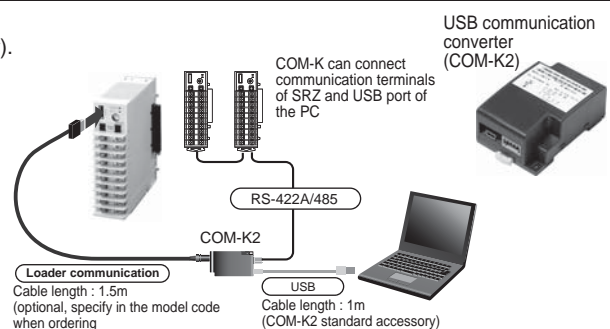

Model Code : USB communication converter (COM-K2)

| Specifications             | Model and Suffix code              |   |
|----------------------------|------------------------------------|---|
|                            | COM - K -                          |   |
| Loader communication cable | Without loader communication cable | N |
|                            | With loader communication cable    | 1 |

# Module type Digital Temperature Controller SRZ

## Display unit

### Operation Panel : OPC-V606E

5.7 inches STN monochrome LCD operation panel

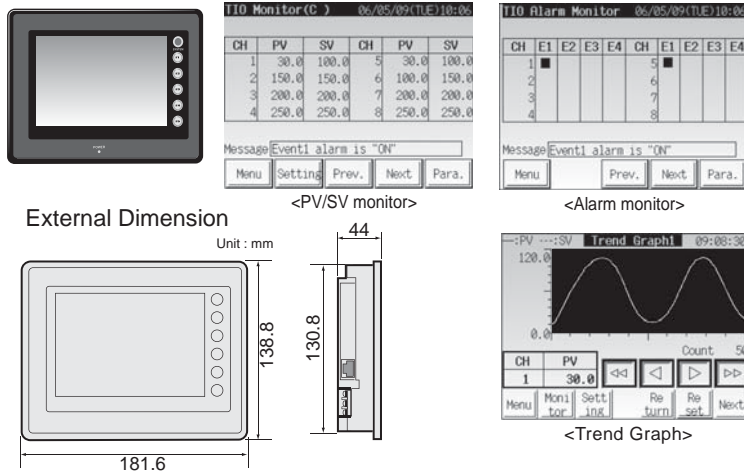

#### External Dimension

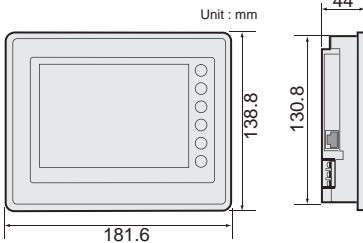

#### Specifications

Display : STN monochrome LCD  
 Power supply voltage : 24V DC  
 Power consumption : Less than 10W  
 Ambient temperature : 0 to 50°C  
 Ambient humidity : Less than 85% RH  
 Waterproof/Dustproof : IP65  
 Weight : IP65  
 Compliance : cUL, CE marking

Maximum number of modules:  
 31 modules (16 Z-TIO-A/B and 16 DIO modules)

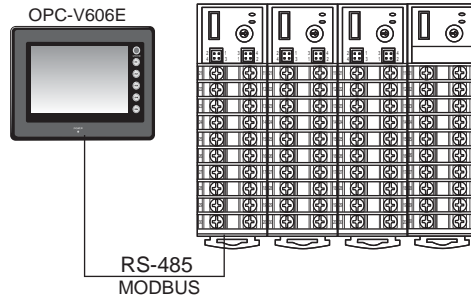

#### Model Code

| Specifications       | No | Model Code                  | ① | ② | ③ |
|----------------------|----|-----------------------------|---|---|---|
| OPC-V606E-           |    |                             |   |   |   |
| Display method       | ①  | STN monochrome LCD          | 3 |   |   |
| Available controller | ②  | Z-TIO/DIO (MODBUS protocol) |   | 5 |   |
| Language             | ③  | Japanese                    |   |   | J |
|                      |    | English                     |   |   | E |

Accessories (Sold separately)

| Specifications                                  | Model  |
|---|--------|
| Cable : Between OPC-V606E and Z-TIO (Length 3m) | V6-MLT |

### Compact Setting Display : OP10

This DIN rail mounted compact display and setting unit is suitable for on-site operation change and monitoring.

- ◆ Monitor item
  - Measured value (PV)
  - Set value (SV)
  - Heat-side output value (MV)
  - Cool-side output value (Mc)
  - Event 1 status (A1)
  - Event 2 status (A2)
- ◆ Setting item
  - Autotuning
  - Event 1 (A1)
  - Event 2 (A2)
  - Heat-side proportional band (P)
  - Heat-side integral time (I)
  - Heat-side derivative time (D)
  - Cool-side proportional band (Pc)
  - PV bias (Pb)

#### ◆ Setting by MODBUS register address

Any Modbus register address can be specified to set or display data. This is used to set or display data that is not included within the OP10 parameter.

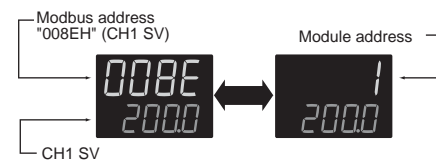

Maximum number of modules:  
 Z-TIO : 16 modules (Max. 99CH)  
 Z-COM : 16 modules (Max. 99CH)

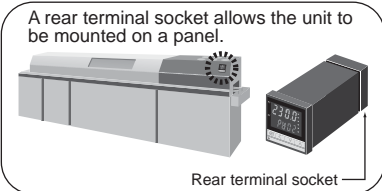
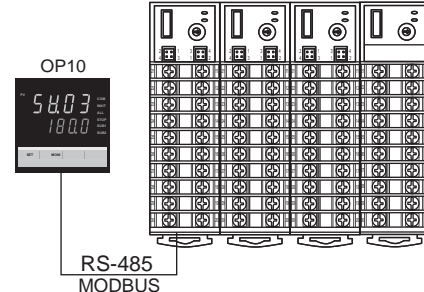

#### Specifications

Display: LCD display, 4-digitX2 (Green/Orange)  
 Power supply voltage :  
 a) 100 to 240V AC (Rating), 50/60Hz  
 b) 24V AC (Rating), 50/60Hz  
 c) 24V DC (Rating)  
 Power consumption  
 4VA max. (at 100V AC) 7VA max. (at 240V AC)  
 4VA max. (at 24V AC) 100mA max (at 24V DC)  
 Ambient temperature: 0 to 50°C  
 Ambient humidity: 45 to 85% RH  
 Waterproof/Dustproof: IP66 (Option)  
 Weight: Approx 120g  
 Compliance with standard: cUL, CE marking, C-Tick

#### External Dimension

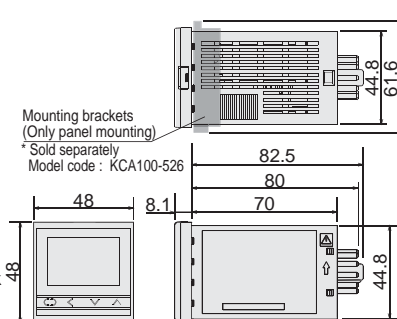

#### Model Code

| Specifications       | No | Model Code   | ① | ② | ③                    |
|----------------------|----|--|---|---|----------------------|
| OP10-                |    |  |   |   |                      |
| Power supply         | ①  | 24V AC/DC<br>100 to 240V AC  | 3 | 4 |                      |
| Waterproof/dustproof | ②  | No waterproof/dustproof<br>Waterproof/dustproof  |   |   | N<br>1               |
| Available controller | ③  | Z-COM-A (Modbus protocol)<br>Z-TIO (Modbus protocol)<br>V-TIO-E/F (RS-422A, Modbus protocol)<br>H-PCP-J (RS-422A, Modbus protocol) |   |   | 01<br>02<br>03<br>04 |

Accessories (Sold separately)

| Specifications  | Model        |
|---|--------------|
| RS-485 cable : Between OP10 and Z-TIO (Length 1m)                 | W-BO-01-1000 |
| RS-485 cable : Between OP10 and Z-COM / H-PCP-J (Length 1m)       | W-BO-04-1000 |
| RS-485 cable : Between OP10 and Z-COM / V-TIO/H-PCP-J (Length 1m) | W-BO-05-1000 |

#### ● Socket (Sold separately) External Dimensions

DIN rail mounting socket type  
 Model : ATC180041  
 (Matsushita Denko product)

Rear terminal socket type  
 Model : AT78051  
 (Matsushita Denko product)

Mounting brackets  
 (Only panel mounting)  
 \* Sold separately  
 Model code : KCA100-526

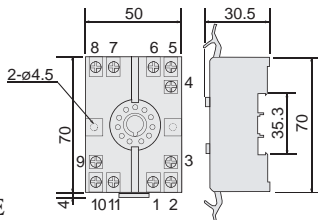

Screw hole dimension for wall mounting  
 2-φ4.5 Mounting hole  
 40 ±0.2

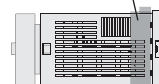
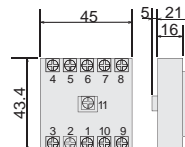



## Specifications

### Temperature control module (Z-TIO)

#### Input

##### Number of inputs

- 4 points (Z-TIO-A), 2 points (Z-TIO-B)
- Isolated between each channel.

##### Input

- Universal input
- Temperature, Current, Low voltage input group
- Thermocouple : K, J, R, S, B, E, T, N (JIS/IEC), PLII (NBS), W5Re/W26Re (ASTM)
  - Influence of external resistance : Approx. 0.125μV/Ω
  - Input break action : Up-scale / Down-scale (Selectable)
- RTD : Pt100 (JIS/IEC), JPt100 (JIS)
  - Influence of input lead resistance : Approx. 0.02[%/Ω] of reading
  - Maximum 10Ω per wire
  - Input break action : Up-scale
- Low voltage : 0 to 1V DC, 0 to 100mV DC, 0 to 10mV DC,
  - Input break action : Up-scale / Down-scale (Selectable)
- Current : 4 to 20mA DC, 0 to 20mA DC
  - Input break action : Uncertain (indicates a value around 0mA)
- High voltage input group
- High voltage : 0 to 5V DC, 1 to 5V DC, 0 to 10V DC
  - Input break action : Uncertain (indicates a value around 0V)

##### Sampling Time

0.25 sec

##### Input Digital Filter

0.1 to 100.0 sec (OFF when 0 is set.)

##### PV Bias

-span to +span

##### PV Ratio

0.500 to 1.500

##### Square Root Extraction

Equation :  $PV = \sqrt{\text{Input value} \times PV \text{ ratio} + PV \text{ bias}}$   
 Low level cut OFF : 0.00 to 25.00% of span

#### Performance

##### Measuring Accuracy

- a) Thermocouple
  - Type : K, J, T, E, N, PLII
    - Less than -100°C (-148°F) : ±2.0°C (±3.6°F)
    - 100 to 500°C (-148 to 932°F) : ±1.0°C (±1.8°F)
    - More than 500°C (932°F) : ±(0.2% of Reading + 1 digit)
  - Type : N, S, R, W5Re/W26Re
    - Less than 1000°C (1832°F) : ±2.0°C (±3.6°F)
    - More than 1000°C (1832°F) : ±(0.2% of Reading + 1 digit)
  - Type : B
    - Less than 400°C (752°F) : ±70.0°C (±126°F)
    - 400 to 1000°C (752 to 1832°F) : ±2.0°C (±3.6°F)
    - More than 1000°C (1832°F) : ±(0.2% of Reading + 1 digit)
- Cold junction temperature compensation error when close horizontal mounting
  - Terminal type : ±1.0°C (1.8°F) [at 23±2°C (73±3.6°F)]
    - Less than -100°C (-148°F) input : ±2.0°C (±3.6°F)
  - Connector type : ±2.0°C (3.6°F) [at 23±2°C (73±3.6°F)]
    - Less than -100°C (-148°F) input : ±4.0°C (±7.2°F)
- b) RTD
  - Less than 200°C (392°F) : ±0.4°C (±0.8°F)
  - More than 200°C (392°F) : ±(0.2% of Reading + 1 digit)
- c) DC voltage and DC current
  - ±(0.2% of span)

##### Insulation Resistance

More than 20MΩ (500V DC) between measured terminals and ground  
 More than 20MΩ (500V DC) between power terminals and ground  
 More than 20MΩ (500V DC) between measured terminals and power terminals

##### Dielectric Strength

750V AC for one minute between measured terminals and ground  
 750V AC for one minute between power terminals and ground  
 750V AC for one minute between measured terminals and power terminals

#### Control

##### Control Method

- a) Brilliant II PID control
  - Available for reverse and direct action.
- b) Brilliant PID control (Heat/Cool type)
- c) Position proportioning control without feedback resistance.
  - a), b), c) is selectable.

##### Autotuning Method

- a) For PID control (Direct action/Reverse action)
- b) For Heat/Cool PID control (For extruder, air cooling type)
- c) For Heat/Cool PID control (For extruder, water cooling type)
- d) For Heat/Cool PID control
- e) For Position proportioning control without feedback resistance

##### Startup tuning

- The condition to activate Startup Tuning is selectable among a) to g)
- a) At power-on, one-time tuning
  - b) At SV change, one-time tuning
  - c) At power-on and SV change, one-time tuning
  - d) At power-on, always on
  - e) At SV change, always on
  - f) At power-on and SV change, always on
  - g) Function off
- (Not available for Position proportioning control without feedback resistance)

##### Major Setting Range

- Set value : Same as input range.
- Proportional band : 0 to input span (°C, °F) (Temperature input)  
0.0 to 1000.0% of span (Voltage, Current input) (ON/OFF control when P = 0)
- Integral time : 0 to 3600sec. or 0.0 to 1999.9sec. (selectable)
- Derivative time : 0 to 3600sec. or 0.0 to 1999.9sec. (selectable)
- Cool-side proportional band : 1(0.1,0.01) to input span (°C, °F)(Temperature input)  
0.1 to 1000.0% of span (Voltage, Current input)
- Cool-side integral time : 0 to 3600sec. or 0.0 to 1999.9sec. (selectable)
- Cool-side derivative time : 0 to 3600sec. or 0.0 to 1999.9sec. (selectable)
- Deadband/Overlap : -span to +span (Temperature input)  
-100.0 to +100.0% of span (Voltage, Current input)
- Control response : Slow, Medium, Fast
- Ramp-to-setpoint : 0 to span per Time  
(Time is selectable between 1 and 3600 sec) (Up/Down individual setting)
- Output limiter : -5.0 to +105.0% (High/Low individual setting)
- Cool-side output limiter : -5.0 to +105.0% (High/Low individual setting)
- Output change rate limiter : 0.0 to 100.0%/sec. (Up/Down individual setting)
- Cool-side output change rate limiter : 0.0 to 100.0%/sec. (Up/Down individual setting)
- Proportional cycle time : 0.1 to 100.0 sec.
- Cool-side proportional cycle time : 0.1 to 100.0 sec.
- Manual reset : -100.0 to +100.0%
- Manual output : Output limiter low to output limiter high
- Output at control stop mode : -5.0 to 100.5% (Heat/Cool individual setting)

##### Motor Valve Control (position proportioning control type only)

- Motor time : 5 to 1000 sec. (full open to full close)
- Integral output limiter : OFF, 100.0 to 200.0% of motor time
- Neutral zone : 0.1 to 10.0%
- Differential gap : 0.1 to 5.0%
- Valve action at a stop mode : a) CLOSE : OFF, OPEN : OFF  
b) CLOSE : ON, OPEN : OFF  
c) CLOSE : OFF, OPEN : ON  
• a), b), c) is selectable.

##### Memory area

- Number of memory area : 8 memory areas
- Setting item : Set value (SV), Proportional band, Integral time, Derivative time, Cool-side proportional band, Cool-side integral time, Cool-side derivative time, Deadband/Overlap, Control response, Manual reset, Ramp-to-setpoint (Up/Down), Event set vale, LBA time, LBA deadband, Soak time : 0 min 0.00 sec to 199 min 59 sec or 0 hr 00 min to 9 hr 59 min (selectable)
- Linking area number : OFF, 1 to 8

##### Output Type

- Relay output : Form A contact, 250V AC 3A (resistive load)
- Voltage pulse output : 0/12V DC  
(Load resistance : More than 600Ω)  
• Power supply and output are not isolated.
- Current output : 4 to 20mA DC, 0 to 20mA DC  
(Load resistance : Less than 600Ω)  
• Power supply and output are not isolated.
- Continuous voltage output : 0 to 1V DC, 0 to 5V DC, 1 to 5V DC, 0 to 10V DC  
(Load resistance : More than 1kΩ)  
• Power supply and output are not isolated.
- SSR (Triac) output : Rated current : 0.5A
- Open collector output : Load voltage : Less than 30V DC,  
(Sink type) Maximum load current : Less than 100mA  
ON voltage : Less than 2V DC (at 100mA)



## Specifications

### Temperature control module (Z-TIO)

#### Event (Alarm)

##### Number of Event Setting

Up to 4 points (Event 1 to 4)

##### Alarm Type

Process high, Process low, Deviation high, Deviation low, Deviation high/low, Band, Set value high, Set value low, MV value high, MV value low, Cool side MV value high, Cool side MV value low, FBR value high, FBR value low, LBA (Control loop break alarm), Deviation high between channel, Deviation low between channel, Deviation high/low between channel, Deviation band between channel, Temperature rise completion

- LBA is assignable to event 4.
- Temperature rise completion is assignable to event 3.

##### Setting range

Deviation, Deviation between channel, Temperature rise completion  
 : - (Input span) to + (input span)  
 Differential gap : 0 to input span  
 Process, Set value : Same as input range  
 Differential gap : 0 to input span  
 MV value, FBR valued : -5.0 to +105.0%  
 Control loop break alarm (LBA)  
 : LBA time : 0 to 7200 sec. (OFF by setting zero)  
 LBA deadband : 0 to input span

##### Other Functions

- Hold/Re-hold action (Valid for deviation/band/process alarm only)
  - Hold action is activated at Power-up and STOP to RUN.
  - Re-hold action is activated at Power-up, STOP to RUN, and the control set value change.
- Event action is configurable in case of input abnormality.
- Energized/de-energized action is configurable.
- Delay timer : 0 to 1800 sec
- Interlock (latch) function is configurable.

#### Heater Break Alarm (Optional)

**Number of CT Input :** 4 points (4ch type), 2 points (2ch type)  
**CT Input type :** CTL-6-P-N (30A), CTL-12-S56-10L-N(100A)

**Accuracy :** ± 5% of input value or ± 2A (whichever is larger)  
**Display range :** 0.0 to 100.0A

#### Communications

**Communication method :** RS-485  
**Communication speed :** 4800, 9600, 19200, 38400 BPS  
**Protocol :** a) ANSI X3.28(1976) 2.5 B1 (RKC standard)  
 b) MODBUS- RTU  
 c) PLC special protocol (Mapman): Z-TIO-C/D Module  
 Correspond to MITSUBISHI MELSEC PLC series  
 1. A compatible, 1C Frame (type 4)  
 AnA/AnU common command (QR/QW)  
 (AnA, QnA series, Q series)  
 QnA compatible, 3C Frame (type 4) command (0401/1401)  
 (QnA/Q series) • Z Resistor only  
 2. A compatible, 1C Frame (type 4)  
 ACPU common command (WR/WWW)  
 (A series, FX2N, FX2NC series)

**Bit format :** Start bit : 1, Data bit : 7 or 8 • For MODBUS 8 bit only  
 Parity bit : Without, Odd or Even,  
 Stop bit : 1 or 2 • For MODBUS 1 bit

**Maximum connection :** Z-TIO-A/B ; 32 modules, Z-TIO-C/D : 16 modules

#### Other Functions

**Remote set input**  
**Temperature ratio setting**  
**Cascade control mode**

**Output ratio distribution function**  
 Function which distributes the control output value of the master channel to the Z-DIO/TIO module output.

**EDS function**  
 Function which suppresses overshoot and undershoot.

**Auto-temperature-rise with learning function**  
 Function which achieves temperature uniformity at ramp-up in the same control group while learning function calculates optimum parameter settings for this function.  
 Up to 16 groups can be configured within modules which are connected each other by connectors on the base.

**Peak current suppression function**  
 When the output type is time proportional output, the peak current suppression function changes the start timing of the proportional cycle so that the outputs of the channels do not turn ON simultaneously.  
 • The peak current suppression function is performed in one modules.

**Master-slave Mode**  
 With this function, when a mode of Mode-master channel is changed, the mode of all slave channels (preset) will be also automatically changed. Modes can be selected among various mode function such as memory area (recipe).

### Digital input/output module (Z-DIO)

#### Digital Input

##### Number of inputs

- 8 points  
 • Isolated input (4 points/common)

##### Input method

Voltage contact input  
 Open : Less than 5.0V, Close : More than 17.5V  
 Contact current : Less than 3.0mA  
 Allowable input voltage : Less than 26.4V DC

##### Function

Interlock reset, RUN/STOP, Remote/Local, Auto/Manual, Memory area selection, External disturbance suppression

##### Function allocation

See digital input allocation table

#### Digital Output

##### Number of inputs

- 8 points  
 • 4 points/common

##### Output signal

- Relay contact output, Form a contact  
 250V AC 1A , 30V DC 1A (Resistive load)
- Open collector output (Sink type)  
 Allowable load current : Less than 100mA  
 Load voltage : Less than 30V  
 Minimum load : 0.5mA  
 ON voltage : Less than 2.0V (at maximum load current)  
 Leakage current at OFF : Less than 0.1mA

##### Function

Event 1 output (CH1 to CH4), Event 2 output (CH1 to CH4)  
 Event 3 output (CH1 to CH4), Event 4 output (CH1 to CH4)  
 HBA output, Burn-out status output, Temperature rise completion output, Manual output

##### Function allocation

See output allocation table

#### Communications

**Communication method :** RS-485  
**Communication speed :** 4800, 9600, 19200, 38400 BPS  
**Protocol :** ANSI X3.28(1976) 2.5 B1  
 MODBUS  
**Bit format :** Start bit : 1, Data bit : 7 or 8 • For MODBUS 8 bit only  
 Parity bit : Without, Odd or Even,  
 Stop bit : 1 or 2 • For MODBUS 1 bit  
**Maximum connection :** 16 units

### CT (Current transformer) input module (Z-CT)

#### Input

**Number of CT Input :** 12 points  
**CT Input type and range :** CTL-6-P-Z : 0.0 to 10.0A  
 CTL-6-P-N : 0.0 to 30.0A  
 CTL-12-S56-10L-N : 0.0 to 100.0A  
 • Selectable

##### Sampling cycle :

3 sec

##### Accuracy :

CTL-6-P-Z : ± 0.3A  
 CTL-6-P-N : ± 5% of input value or ± 2A (whichever is larger)  
 CTL-12-S56-10L-N : ± 5% of input value or ± 2A (whichever is larger)

#### Event (Alarm)

**Alarm type :** Heater break alarm (HBA) and Heater over current alarm  
 • Interlock (latch) function is configurable.  
 • Alarm delay time : 0 to 255 times

##### Setting method

- Via communication or push-button switch
- Automatic alarm setting function is available.

##### CT allocation

Module address setting and channel setting

#### Communications

**Communication method :** RS-485  
**Communication speed :** 4800, 9600, 19200, 38400 BPS  
**Protocol :** ANSI X3.28(1976) 2.5 B1  
 MODBUS  
**Bit format :** Start bit : 1, Data bit : 7 or 8 • For MODBUS 8 bit only  
 Parity bit : Without, Odd or Even,  
 Stop bit : 1 or 2 • For MODBUS 1 bit  
**Maximum connection :** 16 units

## Specifications

### Communication Extension module (Z-COM)

#### Communications

**Communication method :** RS-485/RS-422A  
**Communication speed :** 4800, 9600, 19200, 38400 BPS  
**Protocol :**  
 a) ANSI X3.28(1976) 2.5 B1 (RKC standard)  
 b) MODBUS- RTU  
 c) PLC special protocol (Mapman)  
 Correspond to PLC  
 MITSUBISHI MELSEC series  
 AnA/AnU common command (QR/QW)  
 (AnA, QnA series, Q series)  
 OMRON SYSMAC series  
 C mode command (WD/RD/WE/RE)  
**Bit format :** Start bit : 1, Data bit : 7 or 8 • For MODBUS 8 bit only  
 Parity bit : Without, Odd or Even,  
 Stop bit : 1 or 2 • For MODBUS 1 bit

**Communication allocation**  
 Communication 1 (COM PORT 1 to 2)  
 RKC standard or MODBUS protocol  
 Communication 2 (COM PORT 3 to 4)  
 RKC standard, MODBUS protocol or PLC special protocol (Mapman)

**Maximum connection**  
 RKC standard/MODBUS protocol : 16 units  
 PLC special protocol : 4 units

**Maximum connection function module**  
 Same function module : 16 modules/unit  
 Total function module : 31 modules/unit

### Z-TIO/Z-DIO/Z-CT/Z-COM Common specifications

#### General Specifications

**Supply Voltage**  
 21.6 to 26.4V DC (Ripple rate 10% p-p or less) [Rating:24VDC]

**Power Consumption**  
 a) Z-TIO : Less than 140mA, Surge current : Less than 10A  
 b) Z-DIO : Less than 70mA, Surge current : Less than 10A  
 c) Z-CT : Less than 70mA, Surge current : Less than 10A  
 d) Z-COM : Less than 30mA, Surge current : Less than 10A

**Power Failure Effect**  
 A power failure of 4m sec or less will not affect the control action.  
 • If power failure of more than 20m sec occurs, controller will restart with the state of HOT or COLD start (Only Z-TIO)

**Memory Backup :** Backed up by non-volatile memory (FRAM)  
 • Data retaining period : Approx. 10 years  
 • Number of writing : Approx. 1,000,000,000,000 times.  
 (Depending on storage and operating conditions.)

**Operating Environments :** -10 to 50°C [14 to 122°F]  
 5 to 95% RH.  
 Absolute humidity : MAX. W.C 29.3g/m<sup>3</sup> dry air at 101.3kPa.

**Net Weight**  
 Z-TIO Terminal type : Approx 130g (2ch type), Approx 160g (4ch type)  
 Z-TIO Connector type : Approx 120g (2ch type), Approx 140g (4ch type)  
 Z-DIO Terminal type : Approx 150g (DI/DO 8ch type),  
 Approx 120g (DI 8ch type),  
 Approx 140g (DO 8ch type)  
 Z-DIO Connector type : Approx 130g (DI/DO 8ch type),  
 Approx 100g (DI 8ch type),  
 Approx 120g (DO 8ch type)  
 Z-CT Terminal type : Approx 160g  
 Z-CT Connector type : Approx 140g  
 Z-COM : Approx 110g

**External Dimensions**  
 See external dimensions

## External Dimensions and Rear Terminals

Unit:mm

Temperature Control Module (Z-TIO)  
 Digital Input Output Module (Z-DIO)  
 CT Input Module (Z-CT)i

Communication Extension Module (Z-COM)

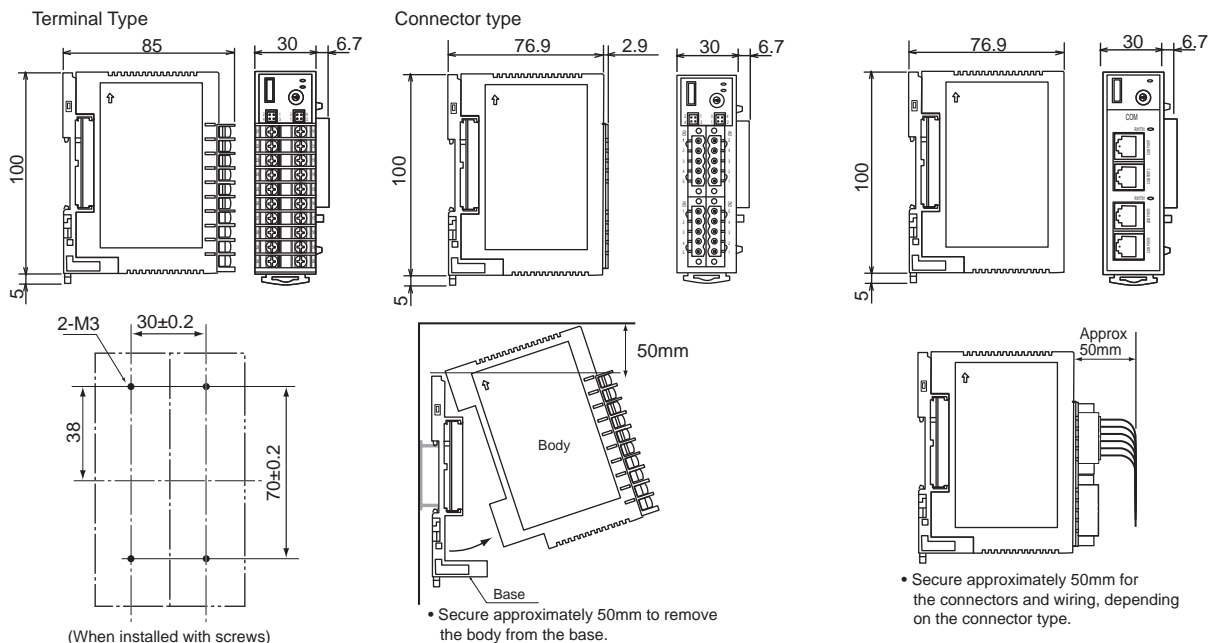

# Module type Process/Temperature Controller SRZ

## Model and Suffix Code

● 4ch type Temperature Control Module (Z-TIO-A/C) • If used as a heat and cool module or position proportional controller then it is only 2 channels.

| Specifications     |   | Model and Suffix Code  |   |   |   |     |     | PID control | Heat/Cool PID control | Position proportional PID control without FBR |                                     |  |
|--------------------|---|--|---|---|---|-----|-----|-------------|-----------------------|---|-------------------------------------|--|
|                    |   | Hardware coding Quick start code 1   |   |   |   |     |     |             |                       |   |                                     |  |
| Model              | Z-TIO-A (Standard type)<br>Z-TIO-C (PLC special protocol : MAPMAN)  | 1  | 2 | 3 | 4 | 5/6 | 7-8 | 9           | / Y                   |   |                                     |  |
| Wiring method      | ① Terminal type<br>Connector type   | T  | C |   |   |     |     |             |                       |   |                                     |  |
| Output 1           | ② See Output Code Table   |  |   |   |   |     |     |             |                       | CH1 output                                    | CH1 Heat output<br>CH1 Open output  |  |
| Output 2           | ③ See Output Code Table   |  |   |   |   |     |     |             |                       | CH2 output                                    | CH1 Cool output<br>CH1 Close output |  |
| Output 3           | ④ See Output Code Table   |  |   |   |   |     |     |             |                       | CH3 output                                    | CH2 Heat output<br>CH2 Open output  |  |
| Output 4           | ⑤ See Output Code Table   |  |   |   |   |     |     |             |                       | CH4 output                                    | CH2 Cool output<br>CH2 Close output |  |
| CT input           | ⑥ Not supplied<br>CT input : 4 points   |  |   |   |   |     | N   | A           |                       |   |                                     |  |
| Initial setting    | ⑦ No quick start code (Default setting)<br>Specify quick start code 1<br>Specify quick start code 1 and 2 (See page 11) |  |   |   |   |     | N   | 1           | 2                     |   |                                     |  |
| Quick start code 1 | Control Method ⑧  | No quick start code<br>4CH PID control with AT (Reverse action)<br>4CH PID control with AT (Direct action)<br>2CH Heat/Cool PID control with AT<br>2CH Heat/Cool PID control with AT for extruder (Air cooling type)<br>2CH Heat/Cool PID control with AT for extruder (Water cooling type)<br>2CH Position proportional PID control without FBR |   |   |   |     |     | No code     |                       |   |                                     |  |
|                    | Input and range ⑨   | No quick start code<br>See Input range Code Table  |   |   |   |     |     | No code     |                       |   |                                     |  |
| Instrument version | ⑩ Version symbol  |  |   |   |   |     |     |             |                       |   | Y                                   |  |

● 2ch type Temperature Control Module (Z-TIO-B/D) • If used as a heat and cool module or position proportional controller then it is only 1 channel.

| Specifications     |   | Model and Suffix Code  |   |     |   |     |   | PID control | Heat/Cool PID control | Position proportional PID control without FBR |                                     |
|--------------------|---|--|---|-----|---|-----|---|-------------|-----------------------|---|-------------------------------------|
|                    |   | Hardware coding Quick start code 1   |   |     |   |     |   |             |                       |   |                                     |
| Model              | Z-TIO-B (Standard type)<br>Z-TIO-D (PLC special protocol : MAPMAN)  | 1  | 2 | 3/4 | 5 | 6-7 | 8 | / Y         |                       |   |                                     |
| Wiring method      | ① Terminal type<br>Connector type   | T  | C |     |   |     |   |             |                       |   |                                     |
| Output 1           | ② See Output Code Table   |  |   |     |   |     |   |             |                       | CH1 output                                    | CH1 Heat output<br>CH1 Open output  |
| Output 2           | ③ See Output Code Table   |  |   |     |   |     |   |             |                       | CH2 output                                    | CH1 Cool output<br>CH1 Close output |
| CT input           | ④ Not supplied<br>CT input : 2 points   |  |   |     |   |     | N | A           |                       |   |                                     |
| Option             | ⑤ Not supplied  |  |   |     |   |     | N |             |                       |   |                                     |
| Initial setting    | ⑥ No quick start code (Default setting)<br>Specify quick start code 1<br>Specify quick start code 1 and 2 (See page 11) |  |   |     |   |     | N | 1           | 2                     |   |                                     |
| Quick start code 1 | Control Method ⑦  | No quick start code<br>2CH PID control with AT (Reverse action)<br>2CH PID control with AT (Direct action)<br>1CH Heat/Cool PID control with AT<br>1CH Heat/Cool PID control with AT for extruder (Air cooling type)<br>1CH Heat/Cool PID control with AT for extruder (Water cooling type)<br>1CH Position proportional PID control without FBR |   |     |   |     |   | No code     |                       |   |                                     |
|                    | Input and range ⑧   | No quick start code<br>See Input range Code Table  |   |     |   |     |   | No code     |                       |   |                                     |
| Instrument version | ⑨ Version symbol  |  |   |     |   |     |   |             |                       |   | Y                                   |

### Input range code table

#### Thermocouple

| Input  | Code            | Range               | Input | Code               | Range               |                 |
|--------|-----------------|---------------------|-------|--------------------|---------------------|-----------------|
| K      | K : 35          | -200.0 to +400.0°C  | J     | J : B6             | 0.0 to 800.0°F      |                 |
|        | K : 40          | -200.0 to +800.0°C  |       | J : B9             | -328 to +2192°F     |                 |
|        | K : 09          | 0.0 to 400.0°C      |       | J : A1             | 0 to 800°F          |                 |
|        | K : 10          | 0.0 to 800.0°C      |       | J : A2             | 0 to 1600°F         |                 |
|        | K : 42          | -200.0 to +1372.0°C | T     | T : 19             | -200.0 to +400.0°C  |                 |
|        | K : 02          | 0 to 400°C          |       | T : C5             | -328 to +752°C      |                 |
|        | K : 04          | 0 to 800°C          |       | T : C6             | 0.0 to +752.0°F     |                 |
|        | K : 41          | -200 to +1372°C     | S     | S : 06             | -50 to +1768°C      |                 |
|        | K : C7          | -328 to +2501°F     |       | S : A7             | -58 to +3214°F      |                 |
|        | K : A4          | 0.0 to 800.0°F      | R     | R : 07             | -50 to +1768°C      |                 |
|        | K : A1          | 0 to 800°F          |       | R : A7             | -58 to +3214°F      |                 |
|        | K : A2          | 0 to 1600°F         | E     | E : 20             | -200.0 to +1000.0°C |                 |
|        | J               | J : 27              |       | -200.0 to +400.0°C | E : B2              | 0.0 to +800.0°F |
|        |                 | J : 32              |       | -200.0 to +800.0°C | E : B1              | -328 to +1832°F |
| J : 08 |                 | 0.0 to 400.0°C      | B     | B : 03             | 0 to 1800°C         |                 |
| J : 09 |                 | 0.0 to 800.0°C      |       | B : B1             | 32 to 3272°F        |                 |
| J : 29 |                 | -200.0 to +1200.0°C | N     | N : 02             | 0 to 1300°C         |                 |
| J : 02 |                 | 0 to 400°C          |       | N : A6             | 32 to 2372°F        |                 |
| J : 04 |                 | 0 to 800°C          |       |                    |                     |                 |
| J : 15 | -200 to +1200°C |                     |       |                    |                     |                 |

#### RTD

| Input  | Code   | Range              |
|--------|--------|--------------------|
| Pt100  | D : 35 | -200.0 to +850.0°C |
|        | D : 21 | -200.0 to +200.0°C |
|        | D : C6 | -328.0 to +752.0°F |
|        | D : D2 | -328 to +1562°F    |
| JPt100 | P : 30 | -200.0 to +640.0°C |
|        | P : C6 | -328.0 to +752.0°F |
|        | P : D2 | -328 to +1184°F    |

#### DC Current • voltage

| Input      | Code   | Range         | Input     | Code   | Range         |
|------------|--------|---------------|-----------|--------|---------------|
| 0 to 10mV  | 1 : 01 | 0.0 to 100.0% | 0 to 10V  | 5 : 01 | 0.0 to 100.0% |
| 0 to 100mV | 2 : 01 |               | 1 to 5V   | 6 : 01 |               |
| 0 to 1V    | 3 : 01 |               | 0 to 20mA | 7 : 01 |               |
| 0 to 5V    | 4 : 01 |               | 4 to 20mA | 8 : 01 |               |

### Output signal code table

| M | Relay contact output | V | Voltage pulse output (0/12V DC) | T | Triac output | D | Open collector output |   |             |
|---|----------------------|---|---------------------------------|---|--------------|---|-----------------------|---|-------------|
| 3 | 0 - 1V DC            | 4 | 0 - 5V DC                       | 5 | 0 - 10V DC   | 6 | 1 - 5V DC             | 7 | 0 - 20mA DC |
|   |                      |   |                                 |   |              |   |                       | 8 | 4 - 20mA DC |



## Model and Suffix Code

### Temperature Control Nodule (Z-TIO) Quick Start Code 2

- Quick start code 2 tells the factory to ship with each parameter preset to the values detailed as specified by the customer. Quick start code is not necessarily specified when ordering, unless the preset is requested. These parameters are software selectable items and can be re-programmed in the field via the manual.

| Specifications         | Quick Start Code 2 |   |                          |                          |                          |                          |
|------------------------|--------------------|---|--------------------------|--------------------------|--------------------------|--------------------------|
|                        | ①                  | ②   | ③                        | ④                        | ⑤                        | ⑥                        |
| Event 1 type           | ①                  | See Event Type Code Table   | <input type="checkbox"/> | <input type="checkbox"/> | <input type="checkbox"/> | <input type="checkbox"/> |
| Event 2 type           | ②                  | See Event Type Code Table   | <input type="checkbox"/> | <input type="checkbox"/> | <input type="checkbox"/> | <input type="checkbox"/> |
| Event 3 type           | ③                  | See Event Type Code Table   | <input type="checkbox"/> | <input type="checkbox"/> | <input type="checkbox"/> | <input type="checkbox"/> |
| Event 4 type           | ④                  | See Event Type Code Table   | <input type="checkbox"/> | <input type="checkbox"/> | <input type="checkbox"/> | <input type="checkbox"/> |
| CT type                | ⑤                  | No CT input   |                          |                          |                          | N                        |
|                        |                    | CTL-6-P-N   |                          |                          |                          | P                        |
|                        |                    | CTL-12-S56-10L-N  |                          |                          |                          | S                        |
| Communication Protocol | ⑥                  | ANSI/RKC standard protocol  |                          |                          |                          | 1                        |
|                        |                    | MODBUS protocol   |                          |                          |                          | 2                        |
|                        |                    | PLC special protocol (MAPMAN) (Mitsubishi MELSEC A/Q series) • Only Z-TIO-C/D |                          |                          |                          | 3                        |
|                        |                    | PLC special protocol (MAPMAN) (Mitsubishi MELSEC FX series) • Only Z-TIO-C/D  |                          |                          |                          | 5                        |

Event Type Code Table

| Event Type                         | Code | Event Type                            | Code |
|------------------------------------|------|---------------------------------------|------|
| No event                           | N    | Deviation High with Alarm Re-Hold     | Q    |
| Deviation High                     | A    | Deviation Low with Alarm Re-Hold      | R    |
| Deviation Low                      | B    | Deviation High/Low with Alarm Re-Hold | T    |
| Deviation High/Low                 | C    | Set value High                        | V    |
| Band                               | D    | Set value Low                         | W    |
| Deviation High with Alarm Hold     | E    | MV value High                         | 1    |
| Deviation Low with Alarm Hold      | F    | MV value Low                          | 2    |
| Deviation High/Low with Alarm Hold | G    | Cool side MV value High               | 3    |
| Process High                       | H    | Cool side MV value Low                | 4    |
| Process Low                        | J    | LBA (Loop break alarm)                | 1 5  |
| Process High with Alarm Hold       | K    | Temperature rise completion           | 2 6  |
| Process Low with Alarm Hold        | L    |                                       |      |

<sup>1</sup> LBA is available with event 4 only.  
<sup>2</sup> Temperature rise completion is available with event 3 only.

### ● Digital Input/Output Module (Z-DIO-A)

| Specifications               | Model and Suffix Code |   | Hardware coding                            | Quick start code |
|------------------------------|-----------------------|---|--|------------------|
|                              | Z-DIO-A               |   |  |                  |
|                              |                       |   | ①-② ③/④-⑤ ⑥ ⑦-⑧                            |                  |
| Wiring method                | ①                     | Terminal type<br>Connector type   | T<br>C                                     |                  |
| Number of digital input (DI) | ②                     | Not supplied<br>DI 8 points   | N<br>A                                     |                  |
| Digital output (DO) signal   | ③                     | Not supplied<br>Relay contact output, 8 points<br>Open Collector output, 8 points | N<br>M<br>D                                |                  |
| Quick start code             | ④                     | No quick start code (Default setting)<br>Specify quick start code                 | N<br>1                                     |                  |
| Quick start code             | ⑤                     | No quick start code<br>No digital input<br>See DI allocation table                | No symbol<br>N<br><input type="checkbox"/> |                  |
|                              | ⑥                     | No quick start code<br>No digital output<br>See DO1 to 4 allocation table         | No symbol<br>N<br><input type="checkbox"/> |                  |
|                              | ⑦                     | No quick start code<br>No digital output<br>See DO5 to 8 allocation table         | No symbol<br>N<br><input type="checkbox"/> |                  |
|                              | ⑧                     | No quick start code<br>ANSI/RKC standard protocol<br>MODBUS protocol              | No symbol                                  | 1<br>2           |

DO1 to 4 Allocation Table

| Code | Digital output    |                            |                   |                   |
|------|-------------------|----------------------------|-------------------|-------------------|
|      | DO 1              | DO 2                       | DO 3              | DO 4              |
| 01   | DO1 manual output | DO2 manual output          | DO3 manual output | DO4 manual output |
| 02   | Event 1 (All CH)  | Event 2 (All CH)           | Event 3 (All CH)  | Event 4 (All CH)  |
| 03   | Event 1 (CH1)     | Event 2 (CH1)              | Event 3 (CH1)     | Event 4 (CH1)     |
| 04   | Event 1 (CH2)     | Event 2 (CH2)              | Event 3 (CH2)     | Event 4 (CH2)     |
| 05   | Event 1 (CH3)     | Event 2 (CH3)              | Event 3 (CH3)     | Event 4 (CH3)     |
| 06   | Event 1 (CH4)     | Event 2 (CH4)              | Event 3 (CH4)     | Event 4 (CH4)     |
| 07   | Event 1 (CH1)     | Event 1 (CH2)              | Event 1 (CH3)     | Event 1 (CH4)     |
| 08   | Event 2 (CH1)     | Event 2 (CH2)              | Event 2 (CH3)     | Event 2 (CH4)     |
| 09   | Event 3 (CH1)     | Event 3 (CH2)              | Event 3 (CH3)     | Event 3 (CH4)     |
| 10   | Event 4 (CH1)     | Event 4 (CH2)              | Event 4 (CH3)     | Event 4 (CH4)     |
| 11   | TIO HBA (CH1)     | TIO HBA (CH2)              | TIO HBA (CH3)     | TIO HBA (CH4)     |
| 12   | Burnout (CH1)     | Burnout (CH2)              | Burnout (CH3)     | Burnout (CH4)     |
| 13   | Temperature rise  | HBA (Comprehensive output) | Burnout (All CH)  | DO4 manual output |

DO5 to 8 Allocation Table

| Code | Digital output    |                            |                   |                   |
|------|-------------------|----------------------------|-------------------|-------------------|
|      | DO 5              | DO 6                       | DO 7              | DO 8              |
| 01   | DO5 manual output | DO6 manual output          | DO7 manual output | DO8 manual output |
| 02   | Event 1 (All CH)  | Event 2 (All CH)           | Event 3 (All CH)  | Event 4 (All CH)  |
| 03   | Event 1 (CH1)     | Event 2 (CH1)              | Event 3 (CH1)     | Event 4 (CH1)     |
| 04   | Event 1 (CH2)     | Event 2 (CH2)              | Event 3 (CH2)     | Event 4 (CH2)     |
| 05   | Event 1 (CH3)     | Event 2 (CH3)              | Event 3 (CH3)     | Event 4 (CH3)     |
| 06   | Event 1 (CH4)     | Event 2 (CH4)              | Event 3 (CH4)     | Event 4 (CH4)     |
| 07   | Event 1 (CH1)     | Event 1 (CH2)              | Event 1 (CH3)     | Event 1 (CH4)     |
| 08   | Event 2 (CH1)     | Event 2 (CH2)              | Event 2 (CH3)     | Event 2 (CH4)     |
| 09   | Event 3 (CH1)     | Event 3 (CH2)              | Event 3 (CH3)     | Event 3 (CH4)     |
| 10   | Event 4 (CH1)     | Event 4 (CH2)              | Event 4 (CH3)     | Event 4 (CH4)     |
| 11   | TIO HBA (CH1)     | TIO HBA (CH2)              | TIO HBA (CH3)     | TIO HBA (CH4)     |
| 12   | Burnout (CH1)     | Burnout (CH2)              | Burnout (CH3)     | Burnout (CH4)     |
| 13   | Temperature rise  | HBA (Comprehensive output) | Burnout (All CH)  | DO8 manual output |

DI Allocation Table

| Code | Digital input                    |             |                       |                  |                       |              |                  |                  |
|------|----------------------------------|-------------|-----------------------|------------------|-----------------------|--------------|------------------|------------------|
|      | DI 1                             | DI 2        | DI 3                  | DI 4             | DI 5                  | DI 6         | DI 7             | DI 8             |
| 01   | Memory area selection (1 to 8)   | Area set    | Operation mode 1      | Operation mode 2 | Alarm interlock reset | AUTO/MANUAL  | LOCAL/REMOTE     | Soak stop        |
| 02   | Memory area selection (1 to 8)   | Area set    | Operation mode 1      | Operation mode 2 | Alarm interlock reset | AUTO/MANUAL  | LOCAL/REMOTE     | Soak stop        |
| 03   | Memory area selection (1 to 8)   | Area set    | Operation mode 1      | Operation mode 2 | Alarm interlock reset | AUTO/MANUAL  | LOCAL/REMOTE     | Soak stop        |
| 04   | Memory area selection (1 to 8)   | Area set    | Operation mode 1      | Operation mode 2 | Alarm interlock reset | AUTO/MANUAL  | LOCAL/REMOTE     | Soak stop        |
| 05   | Memory area selection (1 to 8)   | Area set    | Operation mode 1      | Operation mode 2 | Alarm interlock reset | AUTO/MANUAL  | LOCAL/REMOTE     | Soak stop        |
| 06   | Memory area selection (1 to 8)   | Area set    | Operation mode 1      | Operation mode 2 | Alarm interlock reset | AUTO/MANUAL  | LOCAL/REMOTE     | Soak stop        |
| 07   | Memory area selection (1 to 8)   | Area set    | Operation mode 1      | Operation mode 2 | Alarm interlock reset | AUTO/MANUAL  | LOCAL/REMOTE     | Soak stop        |
| 08   | Memory area selection (1 to 8)   | Area set    | Operation mode 1      | Operation mode 2 | Alarm interlock reset | AUTO/MANUAL  | LOCAL/REMOTE     | Soak stop        |
| 09   | Memory area selection (1 to 8)   | Area set    | Operation mode 1      | Operation mode 2 | Alarm interlock reset | AUTO/MANUAL  | LOCAL/REMOTE     | Soak stop        |
| 10   | Memory area selection (1 to 8)   | Area set    | Operation mode 1      | Operation mode 2 | Alarm interlock reset | AUTO/MANUAL  | LOCAL/REMOTE     | Soak stop        |
| 11   | Memory area selection (1 to 8)   | Area set    | Operation mode 1      | Operation mode 2 | Alarm interlock reset | AUTO/MANUAL  | LOCAL/REMOTE     | Soak stop        |
| 12   | Memory area selection (1 to 8)   | Area set    | Operation mode 1      | Operation mode 2 | Alarm interlock reset | AUTO/MANUAL  | LOCAL/REMOTE     | Soak stop        |
| 13   | Memory area selection (1 to 8)   | Area set    | Operation mode 1      | Operation mode 2 | Alarm interlock reset | AUTO/MANUAL  | LOCAL/REMOTE     | Soak stop        |
| 14   | Memory area selection (1 to 8)   | Area set    | Operation mode 1      | Operation mode 2 | Alarm interlock reset | AUTO/MANUAL  | LOCAL/REMOTE     | Soak stop        |
| 15   | Memory area selection (1 to 8)   | Area set    | Operation mode 1      | Operation mode 2 | Alarm interlock reset | AUTO/MANUAL  | LOCAL/REMOTE     | Soak stop        |
| 16   | Memory area selection (1 to 8)   | Area set    | Operation mode 1      | Operation mode 2 | Alarm interlock reset | AUTO/MANUAL  | LOCAL/REMOTE     | Soak stop        |
| 17   | Memory area selection (1 to 8)   | Area set    | Operation mode 1      | Operation mode 2 | Alarm interlock reset | AUTO/MANUAL  | LOCAL/REMOTE     | Soak stop        |
| 18   | Memory area selection (1 to 8)   | Area set    | Operation mode 1      | Operation mode 2 | Alarm interlock reset | AUTO/MANUAL  | LOCAL/REMOTE     | Soak stop        |
| 19   | Memory area selection (1 to 8)   | Area set    | Operation mode 1      | Operation mode 2 | Alarm interlock reset | AUTO/MANUAL  | LOCAL/REMOTE     | Soak stop        |
| 20   | Memory area selection (1 to 8)   | Area set    | Operation mode 1      | Operation mode 2 | Alarm interlock reset | AUTO/MANUAL  | LOCAL/REMOTE     | Soak stop        |
| 21   | Memory area selection (1 to 8)   | Area set    | Operation mode 1      | Operation mode 2 | Alarm interlock reset | AUTO/MANUAL  | LOCAL/REMOTE     | Soak stop        |
| 22   | Memory area selection (1 to 8)   | Area set    | Operation mode 1      | Operation mode 2 | Alarm interlock reset | AUTO/MANUAL  | LOCAL/REMOTE     | Soak stop        |
| 23   | Memory area selection (1 to 8)   | Area set    | Operation mode 1      | Operation mode 2 | Alarm interlock reset | AUTO/MANUAL  | LOCAL/REMOTE     | Soak stop        |
| 24   | Memory area selection (1 to 8)   | Area set    | Operation mode 1      | Operation mode 2 | Alarm interlock reset | AUTO/MANUAL  | LOCAL/REMOTE     | Soak stop        |
| 25   | Memory area selection (1 to 8)   | Area set    | Operation mode 1      | Operation mode 2 | Alarm interlock reset | AUTO/MANUAL  | LOCAL/REMOTE     | Soak stop        |
| 26   | Memory area selection (2 points) | Area set    | Alarm interlock reset | STOP/RUN         | AUTO/MANUAL           | LOCAL/REMOTE | Operation mode 1 | Operation mode 2 |
| 27   | Memory area selection (1 to 8)   | Area set    | Operation mode 1      | Operation mode 2 | Alarm interlock reset | AUTO/MANUAL  | LOCAL/REMOTE     | Soak stop        |
| 28   | Memory area selection (2 points) | Area set    | Alarm interlock reset | STOP/RUN         | AUTO/MANUAL           | LOCAL/REMOTE | Operation mode 1 | Operation mode 2 |
| 29   | EDS start 1                      | EDS start 2 | Alarm interlock reset | Area set         | AUTO/MANUAL           | LOCAL/REMOTE | Operation mode 1 | Operation mode 2 |

- Area setting is set to disabled at the factory.
- EDS function : External disturbance suppression function

Operation mode 1 : Only monitoring. (Control stop, Event function OFF)  
 Operation mode 2 : Monitoring and Event function (Control stop)

## Model and Suffix Code

### ● CT (Current transformer) Input Module (Z-CT)

| Specifications   | Model and Suffix Code   | Hardware coding only  | Quick start code       |
|------------------|---|---|------------------------|
| Model            | Z-CT  | 1 / 2-3 4   |                        |
| Wiring method    | ① Terminal type<br>Connector type                                   | T<br>C  |                        |
| Quick start code | ② No quick start code (Default setting)<br>Specify quick start code | N<br>1  |                        |
| Quick start code | CT type   | ③ No quick start code<br>CTL-6-P-N (0 to 30A)<br>CTL-12-S56-10L-N (0 to 100A)<br>CTL-6-P-Z (0 to 10A) | No code<br>P<br>S<br>Z |
|                  | Communication protocol  | ④ No quick start code<br>ANSI/RKC standard protocol<br>MODBUS protocol                                | No code<br>1<br>2      |

### ● Communication Module (Z-COM-A)

| Specifications             | Model and Suffix Code   | Hardware coding only  | Quick start code                 |
|----------------------------|---|---|----------------------------------|
| Model                      | Z-COM-A   | 1 2/3 4 5 6   |                                  |
| COM PORT 1,2 communication | ① RS-422A<br>RS-485   | 4<br>5  |                                  |
| COM PORT 3,4 communication | ② RS-422A<br>RS-485   | 4<br>5  |                                  |
| Quick start code           | ③ No quick start code (Default setting)<br>Specify quick start code | N<br>1  |                                  |
| Quick start code           | COM PORT 1,2 communication protocol                                 | ④ No quick start code<br>ANSI/RKC standard protocol<br>MODBUS protocol  | No code<br>1<br>2                |
|                            | COM PORT 3,4 communication protocol                                 | ⑤ No quick start code<br>ANSI/RKC standard protocol<br>MODBUS protocol<br>PLC special protocol (Mitsubishi MELSEC A/Q series)<br>PLC special protocol (OMRON SYSMAC series)<br>PLC special protocol (Mitsubishi MELSEC FX series) | No code<br>1<br>2<br>3<br>4<br>5 |
|                            | Maximum channel data<br>(For PLC special communication)             | ⑥ No quick start code<br>16-channels specification<br>32-channels specification<br>48-channels specification<br>64-channels specification   | No code<br>A<br>B<br>C<br>D      |

### ● Accessories

#### Current transformer for heater break alarm (HBA)

Model : CTL-6-P-N (0 to 30A)

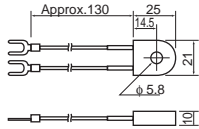

Model : CTL-12-S56-10L-N (0 to 100A)

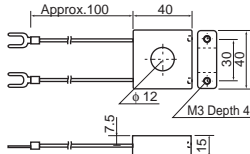

Model : CTL-6-P-Z (0 to 10A)  
[Available for Z-CT module only]

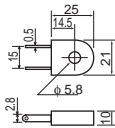

1 (U.R.D.Co.,LTD product)

#### Plug-in connector

(For connector type module)

Model : SRZP-02  
(2 piece)  
(Side screw type)  
Equivalent part :  
MSTB 2.5/5-STF-5,08  
PHOENIX CONTACT

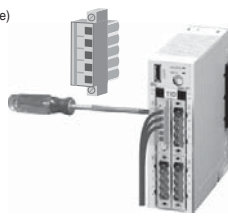

Model : SRZP-01  
(2 piece)  
(Front screw type)  
Equivalent part :  
FRONT-MSTB 2.5/5-STF-5,08  
PHENIX CONTACT



#### End plates

Model : DEP-01  
(2 piece)

To firmly fix the modules,  
use end plates on both  
sides of the mounted modules  
on the DIN rail.



#### Front terminal cover

Model :  
KSRZ-510A



#### Termination resistor connector

Model : W-BW-01  
(For RS-485)  
Model : W-BW-02  
(For RS-422A)



#### Standard accessory

Power supply  
terminal cover  
Model : KSRZ-518A



Connector cover  
Model : KSRZ-517A



#### Communication cables

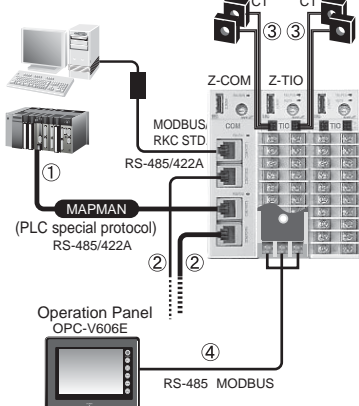

① Model : W-BF-01-3000  
(3m)  
6 pins  
Spade lug terminal \*

\* Other types of cables such as  
cable with 9-pin D-SUB connector  
are also available.  
Please contact RKC.

② Model : W-BF-02-500 (0.5m)  
W-BF-02-1000 (1m)  
W-BF-02-3000 (3m)  
6 pins  
Spade lug terminal

③ Model : W-BW-03-1000 (1m)  
W-BW-03-2000 (2m)  
W-BW-03-3000 (3m)  
4 pins  
Spade lug terminal

④ Model : V6-MLT (3m)  
8 pins  
Spade lug terminal

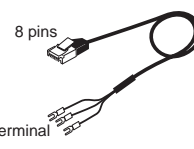
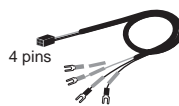
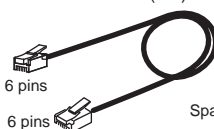

## Terminal/ Connector Configuration

### Temperature Control Module (Z-TIO) Terminal type

| No. | Description  | No. | Description   |
|-----|--|-----|---|
| 21  | Measured Input 3 (CH3)   | 11  | Control Output 1 (CH1)  |
| 22  | (1) Thermocouple<br>(2) RTD<br>(3) Voltage/Current                                 | 12  | (1) Relay contact<br>(2) Voltage pulse/Voltage/Current/Open collector<br>(3) Triac                            |
| 23  |  | 13  | Measured Input 1 (CH1)  |
| 24  | Control Output 3 (CH3)   | 14  | (1) Thermocouple<br>(2) RTD<br>(3) Voltage/Current  |
| 25  | (1) Relay contact<br>(2) Voltage pulse/Voltage/Current/Open collector<br>(3) Triac | 15  |   |
| 26  | Measured Input 4 (CH4)   | 16  | Control Output 2 (CH2)  |
| 27  | (1) Thermocouple<br>(2) RTD<br>(3) Voltage/Current<br>(4) Feedback resistance      | 17  | (1) Relay contact<br>(2) Voltage pulse/Voltage/Current/Open collector<br>(3) Triac                            |
| 28  |  | 18  | Measured Input 2 (CH2)  |
| 29  | Control Output 4 (CH4)   | 19  | (1) Thermocouple<br>(2) RTD<br>(3) Voltage/Current<br>(4) Feedback resistance                                 |
| 30  | (1) Relay contact<br>(2) Voltage pulse/Voltage/Current/Open collector<br>(3) Triac | 20  | (1) Relay contact<br>(2) Voltage pulse/Voltage/Current/Open collector<br>(3) Triac<br>(4) Feedback resistance |

CT : Current transformer for heater break alarm  
Feedback resistance input is used only for monitoring.  
<Caution> Voltage / current outputs are not isolated from the power supply voltage.

\*1 : Optional

### Temperature Control Module (Z-TIO) Connector type

**CN (Connector) 3**

| No. | Description  |
|-----|--|
| 1   | Measured Input 3 (CH3)   |
| 2   | (1) Thermocouple<br>(2) RTD<br>(3) Voltage/Current                                 |
| 3   |  |
| 4   | Control Output 3 (CH3)   |
| 5   | (1) Relay contact<br>(2) Voltage pulse/Voltage/Current/Open collector<br>(3) Triac |

**CN (Connector) 1**

| No. | Description  |
|-----|--|
| 5   | Control Output 1 (CH1)   |
| 4   | (1) Relay contact<br>(2) Voltage pulse/Voltage/Current/Open collector<br>(3) Triac |
| 3   | Measured Input 1 (CH1)   |
| 2   | (1) Thermocouple<br>(2) RTD<br>(3) Voltage/Current                                 |
| 1   |  |

**CN (Connector) 4**

| No. | Description  |
|-----|--|
| 1   | Measured Input 4 (CH4)   |
| 2   | (1) Thermocouple<br>(2) RTD<br>(3) Voltage/Current<br>(4) Feedback resistance      |
| 3   |  |
| 4   | Control Output 4 (CH4)   |
| 5   | (1) Relay contact<br>(2) Voltage pulse/Voltage/Current/Open collector<br>(3) Triac |

**CN (Connector) 2**

| No. | Description  |
|-----|--|
| 5   | Control Output 2 (CH2)   |
| 4   | (1) Relay contact<br>(2) Voltage pulse/Voltage/Current/Open collector<br>(3) Triac |
| 3   | Measured Input 2 (CH2)   |
| 2   | (1) Thermocouple<br>(2) RTD<br>(3) Voltage/Current<br>(4) Feedback resistance      |
| 1   |  |

\* For 2CH specifications, connectors CN3 and CN4 are not mounted. \*1 : Optional  
CT : Current transformer for heater break alarm  
Feedback resistance input is used only for monitoring.  
<Caution> Voltage / current outputs are not isolated from the power supply voltage.

### Digital Input/Output Module (Z-DIO) Terminal type

| No. | Description          | No. | Description                |
|-----|----------------------|-----|----------------------------|
| 21  | DI4                  | 11  | COM <sup>24VDC</sup>   COM |
| 22  | DI3                  | 12  | DO1                        |
| 23  | DI2                  | 13  | DO2                        |
| 24  | DI1                  | 14  | DO3                        |
| 25  | COM <sup>24VDC</sup> | 15  | DO4                        |
| 26  | DI8                  | 16  | COM <sup>24VDC</sup>   COM |
| 27  | DI7                  | 17  | DO5                        |
| 28  | DI6                  | 18  | DO6                        |
| 29  | DI5                  | 19  | DO7                        |
| 30  | COM <sup>24VDC</sup> | 20  | DO8                        |

21-25: Digital Input 1 to 4 (Voltage sink type input)  
26-30: Digital Input 5 to 8 (Voltage sink type input)

11-15: Digital Output 1 to 4  
16-20: Digital Output 5 to 8

### Digital Input/Output Module (Z-DIO) Connector type

**CN (Connector) 3**

| No. | Description          |
|-----|----------------------|
| 1   | DI4                  |
| 2   | DI3                  |
| 3   | DI2                  |
| 4   | DI1                  |
| 5   | COM <sup>24VDC</sup> |

**CN (Connector) 1**

| No. | Description                |
|-----|----------------------------|
| 5   | COM <sup>24VDC</sup>   COM |
| 4   | DO1                        |
| 3   | DO2                        |
| 2   | DO3                        |
| 1   | DO4                        |

**CN (Connector) 4**

| No. | Description          |
|-----|----------------------|
| 1   | DI8                  |
| 2   | DI7                  |
| 3   | DI6                  |
| 4   | DI5                  |
| 5   | COM <sup>24VDC</sup> |

**CN (Connector) 2**

| No. | Description                |
|-----|----------------------------|
| 5   | COM <sup>24VDC</sup>   COM |
| 4   | DO5                        |
| 3   | DO6                        |
| 2   | DO7                        |
| 1   | DO8                        |

### CT (Current transformer) Input Module (Z-CT) Terminal type

| No. | Description | No. | Description |
|-----|-------------|-----|-------------|
| 21  | CT9         | 11  | CT1         |
| 22  | COM         | 12  | COM         |
| 23  | CT8         | 13  | CT2         |
| 24  | COM         | 14  | COM         |
| 25  | CT7         | 15  | CT3         |
| 26  | CT12        | 16  | CT4         |
| 27  | COM         | 17  | COM         |
| 28  | CT11        | 18  | CT5         |
| 29  | COM         | 19  | COM         |
| 30  | CT10        | 20  | CT6         |

21-25: CT Input 7 to 9  
26-30: CT Input 10 to 12

11-15: CT Input 1 to 3  
16-20: CT Input 4 to 6

Screw Size : M3 X 7  
Solderless terminal is recommended  
5.6mm

### CT (Current transformer) Input Module (Z-CT) Connector type

**CN (Connector) 3**

| No. | Description |
|-----|-------------|
| 1   | CT9         |
| 2   | COM         |
| 3   | CT8         |
| 4   | COM         |
| 5   | CT7         |

**CN (Connector) 1**

| No. | Description |
|-----|-------------|
| 5   | CT1         |
| 4   | COM         |
| 3   | CT2         |
| 2   | COM         |
| 1   | CT3         |

**CN (Connector) 4**

| No. | Description |
|-----|-------------|
| 1   | CT12        |
| 2   | COM         |
| 3   | CT11        |
| 4   | COM         |
| 5   | CT10        |

**CN (Connector) 2**

| No. | Description |
|-----|-------------|
| 5   | CT4         |
| 4   | COM         |
| 3   | CT5         |
| 2   | COM         |
| 1   | CT6         |

### Communication Extension Module (Z-COM)

| No. | Description |
|-----|-------------|
| 1   | COM         |
| 2   | COM         |
| 3   | COM         |
| 4   | COM         |
| 5   | COM         |

Communication 1: RKC standard/MODBUS RS-485,422A  
Communication 2: RKC standard/MODBUS PLC special protocol (Mapman) RS-485,422A

### Z-TIO/DIO/CT/COM

Power Supply

- Supply the power to only one of the joined modules. When power is supplied to any one of the joined modules, all of the joined modules will receive power.

Screw Size : M3 X 7  
Solderless terminal is recommended

5.5 mm or less  
3.2 mm or less  
5.6mm

1 2  
+24VDC  
Power Supply

3 4 5  
T/R T/R SG  
(A) (B)  
RS-485  
Communication

\* Z-COM: No.3,4,5 terminals are not mounted.

## Communication Converter Model Code

The SRZ can be connected to various Open Networks via a gateway.

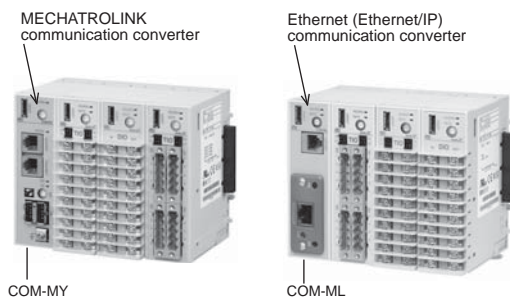
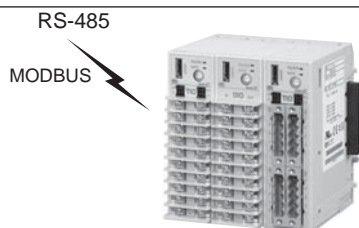
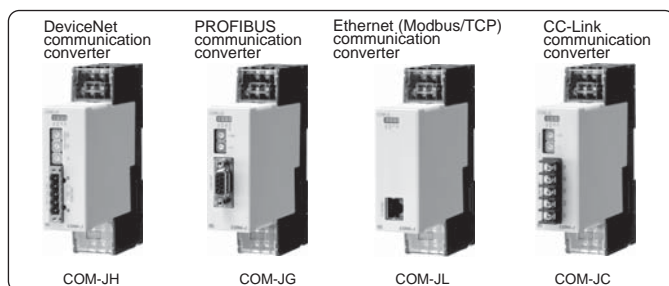

### Model and Suffix Code

#### ● DeviceNet communication converter (COM-JH)

| Specifications          | Model Code                        |                   |
|-------------------------|-----------------------------------|-------------------|
|                         | <b>COM - J</b>                    | <b>H - □ * 02</b> |
| Type                    | DeviceNet communication converter | <b>H</b>          |
| Connector for DeviveNet | Open connector (Unshielded type)  | <b>N</b>          |
|                         | Micro connector (Shield type)     | <b>1</b>          |
| Available controller    | SRZ                               | <b>02</b>         |

#### ● PROFIBUS communication converter (COM-JG)

| Specifications       | Model Code                        |               |
|----------------------|-----------------------------------|---------------|
|                      | <b>COM - J</b>                    | <b>G * 02</b> |
| Type                 | DeviceNet communication converter | <b>G</b>      |
| Available controller | SRZ                               | <b>02</b>     |

#### ● Ethernet (Modbus/TCP) communication converter (COM-JL)

| Specifications       | Model Code                       |                   |
|----------------------|----------------------------------|-------------------|
|                      | <b>COM - J</b>                   | <b>L - □ * 02</b> |
| Type                 | Ethernet communication converter | <b>L</b>          |
| Communication type   | Modbus/TCP                       | <b>N</b>          |
| Available controller | SRZ                              | <b>02</b>         |

#### ● CC-Link communication converter (COM-JC)

| Specifications           | Model Code                      |                   |
|--------------------------|---------------------------------|-------------------|
|                          | <b>COM - J</b>                  | <b>C * 02 - □</b> |
| Type                     | CC-Link communication converter | <b>C</b>          |
| Available controller     | SRZ                             | <b>02</b>         |
| RUN/STOP logic selection | 0 : RUN, 1 : STOP               | <b>1</b>          |
|                          | 0 : STOP, 1 : RUN               | <b>2</b>          |

#### ● Ethernet (Ethernet/IP) communication converter (COM-ML)

| Specifications              | Model Code                       |              |               |
|-----------------------------|----------------------------------|--------------|---------------|
|                             | <b>COM - M</b>                   | <b>L - 2</b> | <b>□ * 02</b> |
| Type                        | Ethernet communication converter | <b>L</b>     |               |
| Ethernet communication type | Ethernet/IP                      | <b>2</b>     |               |
| Host communication type     | RS-422A                          |              | <b>4</b>      |
|                             | RS-485                           |              | <b>5</b>      |
| Available controller        | SRZ                              |              | <b>02</b>     |

#### ● MECHATROLINK communication converter (COM-MY)

| Specifications          | Model Code                           |              |             |
|-------------------------|--------------------------------------|--------------|-------------|
|                         | <b>COM - M</b>                       | <b>Y - □</b> | <b>* 02</b> |
| Type                    | MECHATROLINK communication converter | <b>Y</b>     |             |
| Host communication type | RS-422A                              |              | <b>4</b>    |
|                         | RS-485                               |              | <b>5</b>    |
| Available controller    | SRZ                                  |              | <b>02</b>   |