*High Resolution
Temperature Controller*

REX-F9000

Instruction Manual

Thank you for purchasing this RKC product. In order to achieve maximum performance and ensure proper operation of your new instrument, carefully read all the instructions in this manual. Please place the manual in a convenient location for easy reference.

SYMBOLS

WARNING : This mark indicates precautions that must be taken if there is danger of electric shock, fire, etc., which could result in loss of life or injury.

CAUTION : This mark indicates that if these precautions and operating procedures are not taken, damage to the instrument may result.



: This mark indicates that all precautions should be taken for safe usage.



: This mark indicates important information on installation, handling and operating procedures.



: This mark indicates supplemental information on installation, handling and operating procedures.



: This mark indicates where additional information may be located.



WARNING

- To prevent injury to persons, damage to instrument and equipment, a suitable external protection device shall be required.
- All wiring must be completed before power is turned on to prevent electric shock, fire or damage to instrument and equipment.
- This instrument must be used in accordance with the specifications to prevent fire or damage to instrument and equipment.
- This instrument is not intended for use in locations subject to flammable or explosive gases.
- Do not touch high-voltage connections such as power supply terminals, etc. to avoid electric shock.
- RKC is not responsible if this instrument is repaired, modified or disassembled by other than factory-approved personnel. Malfunction can occur and warranty is void under these conditions.

CAUTION

- This product is intended for use with industrial machines, test and measuring equipment. (It is not designed for use with medical equipment and nuclear energy.)
- This is a Class A instrument. In a domestic environment, this instrument may cause radio interference, in which case the user may be required to take additional measures.
- This instrument is protected from electric shock by reinforced insulation. Provide reinforced insulation between the wire for the input signal and the wires for instrument power supply, source of power and loads.
- Be sure to provide an appropriate surge control circuit respectively for the following:
 - If input/output or signal lines within the building are longer than 30 meters.
 - If input/output or signal lines leave the building, regardless the length.
- This instrument is designed for installation in an enclosed instrumentation panel. All high-voltage connections such as power supply terminals must be enclosed in the instrumentation panel to avoid electric shock by operating personnel.
- All precautions described in this manual should be taken to avoid damage to the instrument or equipment.
- All wiring must be in accordance with local codes and regulations.
- All wiring must be completed before power is turned on to prevent electric shock, instrument failure, or incorrect action.

The power must be turned off before repairing work for input break and output failure including replacement of sensor, contactor or SSR, and all wiring must be completed before power is turned on again.
- To prevent instrument damage as a result of failure, protect the power line and the input/output lines from high currents with a suitable overcurrent protection device with adequate breaking capacity such as a fuse, circuit breaker, etc.
- Prevent metal fragments or lead wire scraps from falling inside instrument case to avoid electric shock, fire or malfunction.
- Tighten each terminal screw to the specified torque found in the manual to avoid electric shock, fire or malfunction.
- For proper operation of this instrument, provide adequate ventilation for heat dispensation.
- Do not connect wires to unused terminals as this will interfere with proper operation of the instrument.
- Turn off the power supply before cleaning the instrument.
- Do not use a volatile solvent such as paint thinner to clean the instrument. Deformation or discoloration will occur. Use a soft, dry cloth to remove stains from the instrument.
- To avoid damage to instrument display, do not rub with an abrasive material or push front panel with a hard object.
- Do not connect modular connectors to telephone line.
- When high alarm with hold action is used for Alarm function, alarm does not turn on while hold action is in operation. Take measures to prevent overheating which may occur if the control device fails.

NOTICE

- This manual assumes that the reader has a fundamental knowledge of the principles of electricity, process control, computer technology and communications.
- The figures, diagrams and numeric values used in this manual are only for purpose of illustration.
- RKC is not responsible for any damage or injury that is caused as a result of using this instrument, instrument failure or indirect damage.
- RKC is not responsible for any damage and/or injury resulting from the use of instruments made by imitating this instrument.
- RKC software is licensed for use with one computer and cannot be modified. This software may not be duplicated except for backup purposes.
- Periodic maintenance is required for safe and proper operation of this instrument. Some components have a limited service life, or characteristics that change over time.
- Every effort has been made to ensure accuracy of all information contained herein. RKC makes no warranty expressed or implied, with respect to the accuracy of the information. The information in this manual is subject to change without prior notice.
- No portion of this document may be reprinted, modified, copied, transmitted, digitized, stored, processed or retrieved through any mechanical, electronic, optical or other means without prior written approval from RKC.

CONTENTS

	Page
1. PREPARATION	1
1.1 Handling Procedure	1
1.2 Check of Product Delivered	2
1.3 Check of Model Code	2
2. MOUNTING	3
2.1 Cautions for Mounting	3
2.2 Dimensions	4
2.3 Mounting Procedures	5
3. WIRING	6
3.1 Cautions for Wiring	6
3.2 Terminal Configuration	8
3.3 Wiring Example	12
4. NAME OF PARTS	13
5. SETTING	16
5.1 Calling-Up Procedure of Monitor and Each Mode	16
5.2 Monitor	18
5.3 Mode Transfer	20
5.4 SV Setting Mode	24
5.5 Operator Set Mode	26
5.6 Setup Mode	30
5.7 Procedure for Selecting CH2 (For 2-channel type)	45

	Page
6. OPERATIONS.....	46
7. DISPLAY AT ABNORMALITY	48
8. REPLACING THE RUBBER PACKING	50
9. FUNCTION DESCRIPTION.	52
9.1 PV Bias.....	52
9.2 Digital Filter.....	52
9.3 Control Response Parameter.	52
9.4 AT Bias.....	53
9.5 Sensor Bias Function	53
9.6 Alarms (ALM).....	54
9.7 Bar-Graph Display	60
9.8 Power Feed Forward Function	61
9.9 Power Supply Frequency Setting	61
9.10 Setting Limiter.....	61
10. SPECIFICATIONS	62

1. PREPARATION

The REX-F9000 is a temperature controller in high resolution, high accuracy and high control stability merchandised mainly for semiconductor manufacturing equipment.

Both 1-channel and 2-channel types of controller are available. For the 2-channel type, as each parameter is independent for each channel, one controller can be used for two loops.

1.1 Handling Procedure

Conduct necessary work according to the following procedures:

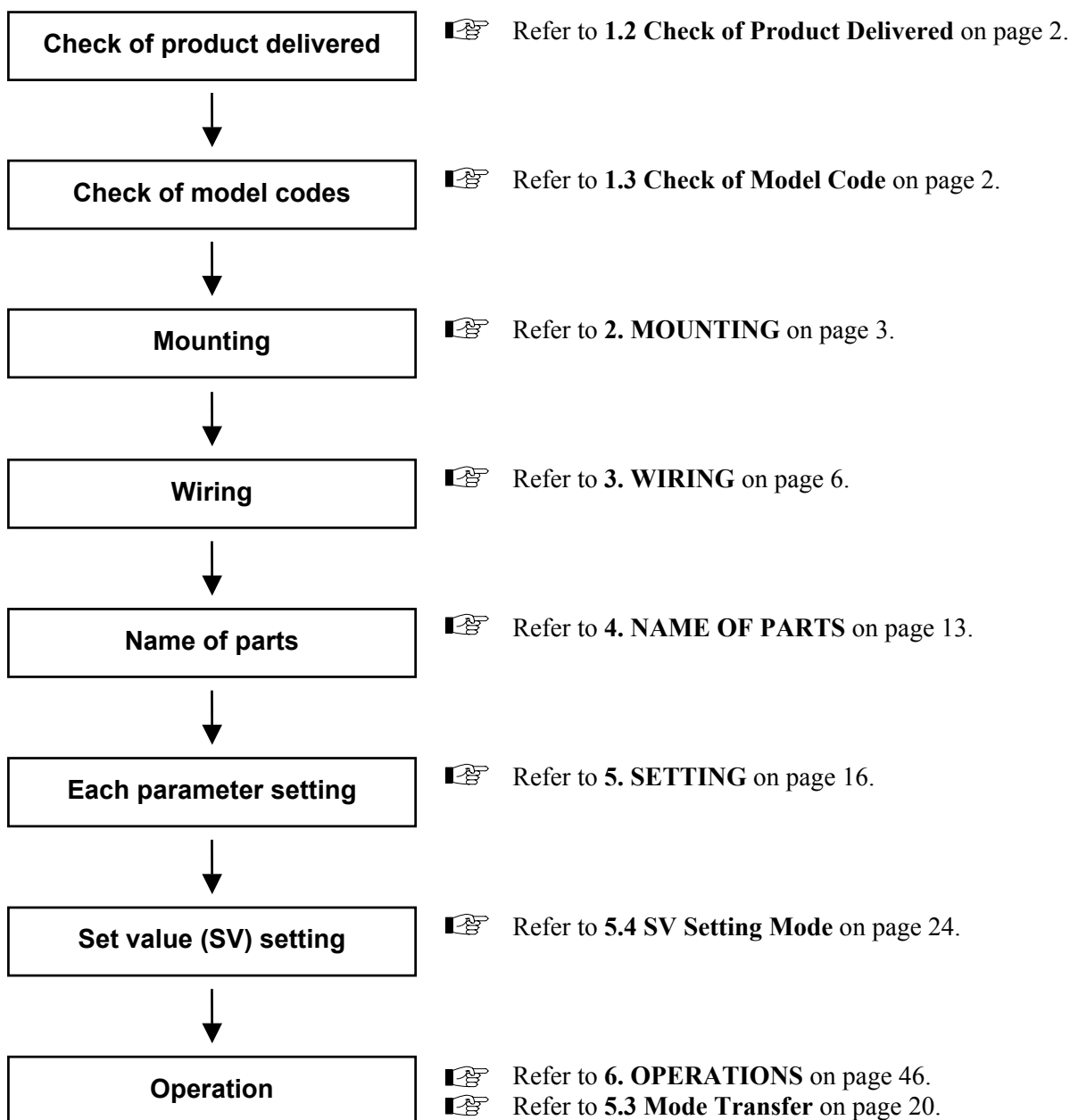

1.2 Check of Product Delivered

Check that the following items are delivered without damage.

- Mainframe: 1 unit
- Mounting bracket: 2 pieces
- Instruction manual (IM9000F01-E5): 1 copy
- Communication Instruction Manual (IM9000F02-E□): 1 copy
- Power feed transformer (PFT-01 or PFT-02) [Optional]: 1 piece (Separate packing)

1.3 Check of Model Code

Check the model code from the following list to determine if the product delivered is as desired.

■ Model code

F9000 – □ □ □ – □ * □ □ / □
 (1) (2) (3) (4) (5) (6) (7)

(1) Number of channel

- 1: 1-channel type
- 2: 2-channel type

(2) Control output [CH1]

- V: Voltage pulse
- 8: Current 4 to 20 mA DC

(3) Control output [CH2]

- N: For the 1-channel type, there is no CH2 control output.
- V: Voltage pulse
- 8: Current 4 to 20 mA DC

(4) Power supply voltage

- 3: 24 V AC/DC
- 4: 100 to 240 V AC

(5) Analog output [CH1] (Optional)

- N: No analog output
- 4: Voltage 0 to 5 V DC
- 6: Voltage 1 to 5 V DC
- 7: Current 0 to 20 mA DC
- 8: Current 4 to 20 mA DC

(6) Analog output [CH2] (Optional)

- N: No analog output
- 4: Voltage 0 to 5 V DC
- 6: Voltage 1 to 5 V DC
- 7: Current 0 to 20 mA DC
- 8: Current 4 to 20 mA DC

(7) Power feed transformer (Optional)

- 1: PFT-01 (100 to 120 V AC)
- 2: PFT-02 (200 to 240 V AC)
- N: No power feed transformer provided



The power feed forward function is standard function.

2. MOUNTING



WARNING

To prevent electric shock or instrument failure, always turn off the power before mounting or removing the instrument.

2.1 Cautions for Mounting

- (1) This instrument is intended to be used under the following environmental conditions. (IEC61010-1)
 - OVERVOLTAGE CATEGORY II
 - POLLUTION DEGREE 2
- (2) Use this instrument within the following environment conditions:
 - Allowable ambient temperature: 0 to 50 °C
 - Allowable ambient humidity: 45 to 85 % RH (No condensation)
 - Installation environment conditions: Indoor use, Altitude up to 2000 m
- (3) Avoid the following conditions when selecting the mounting location:
 - Rapid changes in ambient temperature which may cause condensation.
 - Corrosive or inflammable gases.
 - Direct vibration or shock to the mainframe.
 - Water, oil, chemicals, vapor or steam splashes.
 - Excessive dust, salt or iron particles.
 - Excessive induction noise, static electricity, magnetic fields or noise.
 - Direct air flow from an air conditioner.
 - Exposure to direct sunlight.
 - Excessive heat accumulation.
- (4) Mount this instrument in the panel considering the following conditions:
 - Provide adequate ventilation space so that heat does not build up.
 - Do not mount this instrument directly above equipment that generates large amount of heat (heaters, transformers, semi-conductor functional devices, large-wattage resistors.)
 - If the ambient temperature rises above 50 °C, cool this instrument with a forced air fan, cooler, etc. Cooled air should not blow directly on this instrument.
 - In order to improve safety and the immunity to withstand noise, mount this instrument as far away as possible from high voltage equipment, power lines, and rotating machinery.
 - High voltage equipment: Do not mount within the same panel.
 - Power lines: Separate at least 200 mm.
 - Rotating machinery: Separate as far as possible.
 - For correct functioning mount this instrument in a horizontal position.
- (5) In case this instrument is connected to a supply by means of a permanent connection a switch or circuit-breaker shall be included in the installation. This shall be in close proximity to the equipment and within easy reach of the operator. It shall be marked as the disconnecting device for the equipment.

2.2 Dimensions

Engineering unit: mm

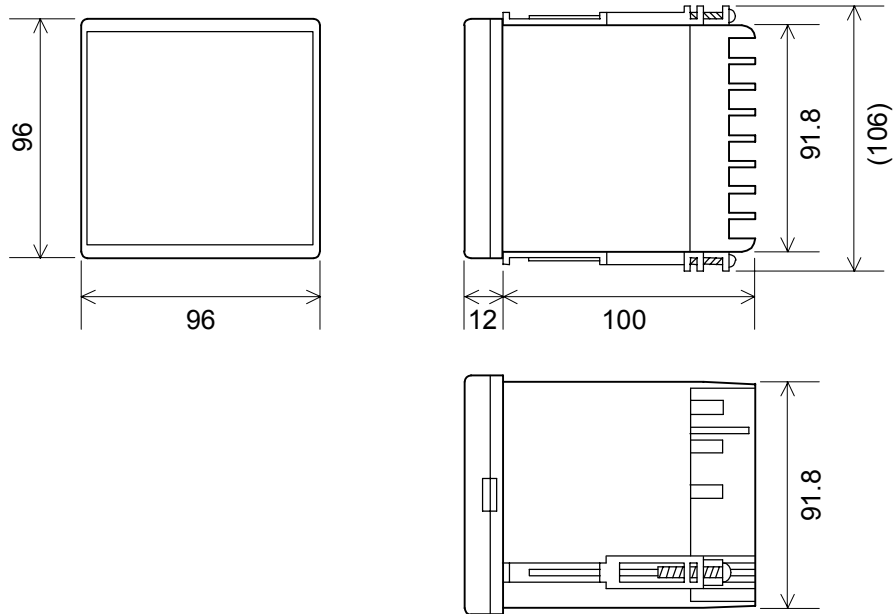
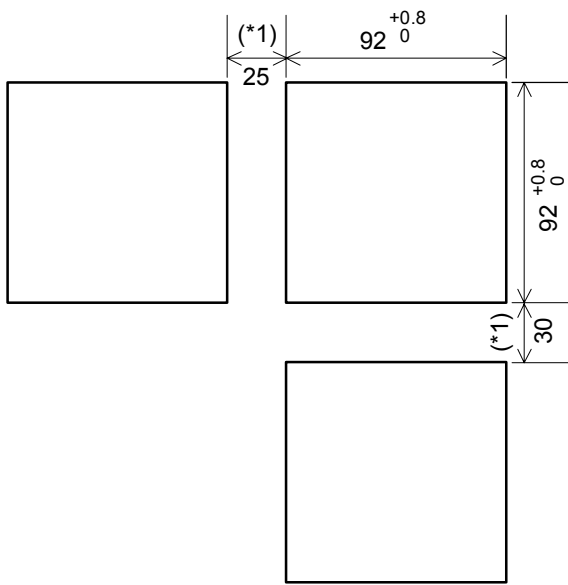
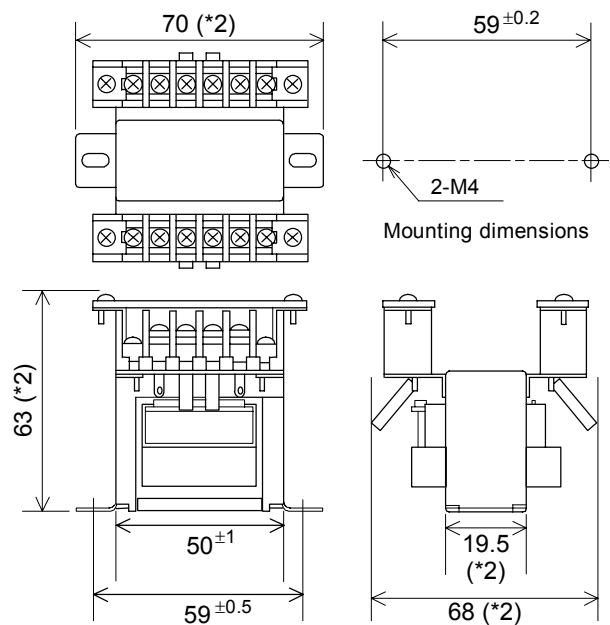

Fig. 2.1 Dimensions



(*1): Minimum

Fig. 2.2 Panel cutout



(*2): Maximum

Fig. 2.3 Dimensions
(Power feed transformer)

2.3 Mounting Procedures

1. Mount the panel cutout corresponding to the number of units on the panel by referring to panel cutout dimensions.
2. Insert the instrument into the panel from the panel cutout.
3. Insert the projections at the bottom of the bracket into the slots at the top of the controller (Fig. 2.4 ①).
4. Then tighten the mounting bracket setscrew from the rear with a Phillips screwdriver. Do not over tighten the bracket setscrew. (Fig. 2.4 ②)
[Recommended tighten torque: 0.3 N·m or less (3 kgf·cm or less)]
5. Set the other mounting bracket in the same way as in 3 and 4.

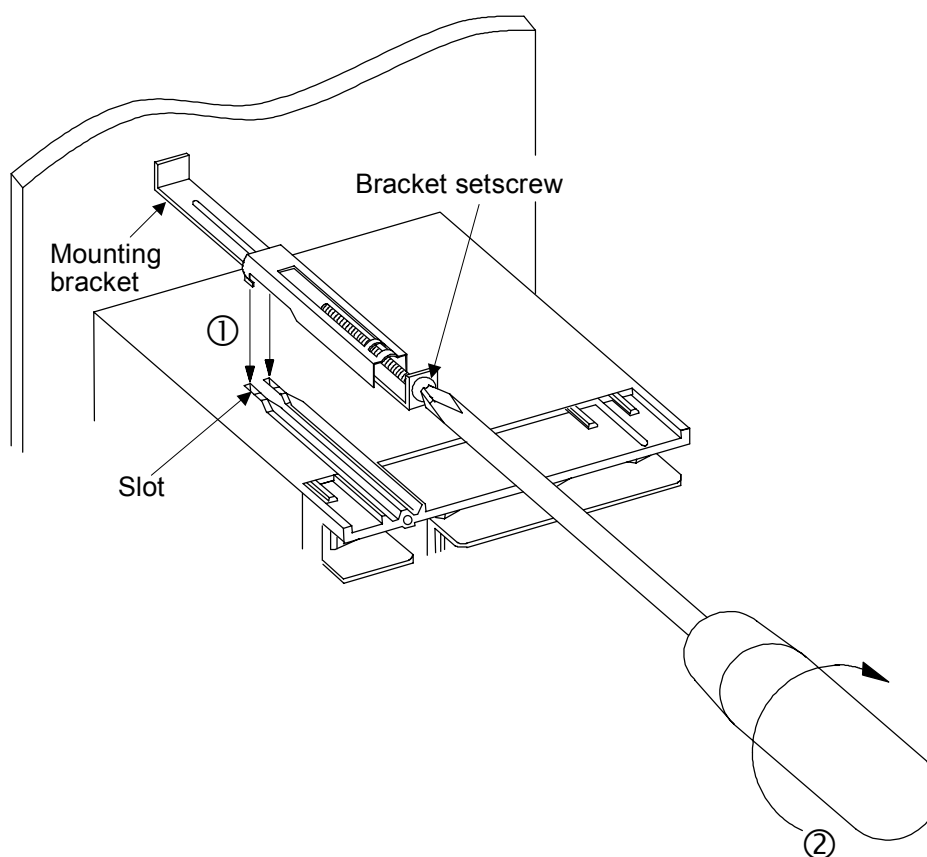

Fig. 2.4 Mounting

3. WIRING



WARNING

To prevent electric shock or instrument failure, do not turn on the power until all wiring is completed. Make sure that the wiring is correct before applying power to the instrument.

3.1 Cautions for Wiring

- (1) For RTD input connection, use lead wires with small lead wire resistance and also with the small resistance difference between each of 3 or 4 lead wires.
- (2) To avoid noise induction, keep input signal wire away from instrument power line, load lines and power lines of other electric equipment.
- (3) Signal connected to Voltage input and Current input shall be low voltage defined as “SELV” circuit per IEC 60950-1.
- (4) If there is electrical noise in the vicinity of the instrument that could affect operation, use a noise filter.
 - Shorten the distance between the twisted power supply wire pitches to achieve the most effective noise reduction.
 - Always install the noise filter on a grounded panel. Minimize the wiring distance between the noise filter output and the instrument power supply terminals to achieve the most effective noise reduction.
 - Do not connect fuses or switches to the noise filter output wiring as this will reduce the effectiveness of the noise filter.

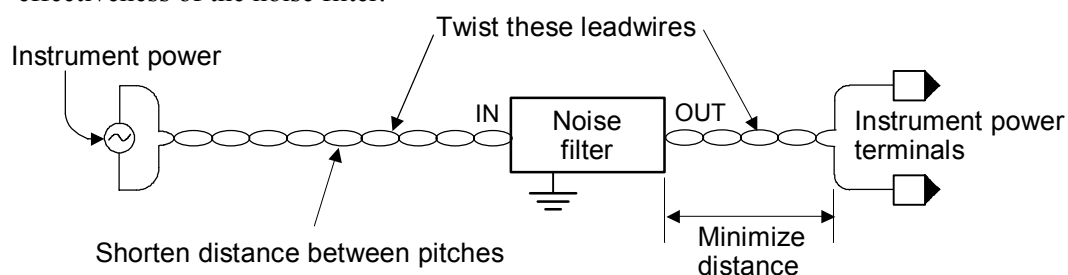

- (5) Allow approximately 5 to 6 seconds for contact output when the instrument is turned on. Use a delay relay when the output line is used for an external interlock circuit.
- (6) Power supply wiring must be twisted and have a low voltage drop.
- (7) This instrument has no power supply switch nor fuses. Therefore, install the fuse close to the instrument and the switch, if required.
 - Fuse type: Time-lag fuse
 - Recommended fuse rating: Rated voltage: 250 V
 - Rated current: 1 A

-
- (8) This instrument with 24 V power supply is not provided with an overcurrent protection device. For safety install an overcurrent protection device (such as fuse) with adequate breaking capacity close to the instrument.
- Fuse type: Time-lag fuse (Approved fuse according IEC60127-2 and/or UL248-14)
 - Fuse rating: Rated current: 0.8 A
- (9) For an instrument with 24 V power supply input, supply power from “SELV” circuit defined as IEC 60950-1.
- (10) A suitable power supply should be considered in end-use equipment. The power supply must be in compliance with a limited-energy circuits (maximum available current of 8 A).
- (11) Use the solderless terminal appropriate to the screw size.
- Screw size: M3 × 8
 - Recommended tightening torque: 0.4 N·m [4 kgf·cm]
 - Maximum allowance tighten torque: 1.0 N·m [10 kgf·cm]
 - Specified solderless terminals: With isolation
 - Applicable wire: Solid/twisted wire of 0.25 to 1.65 mm²
- (12) Make sure that during field wiring parts of conductors can not come into contact with adjacent conductive parts
- (13) Even when only one channel is used for the 2-channel type of controller, connect sensors to both channels. Otherwise, this controller judges that the input line breaks to be set to the FAIL state.
- (14) When no contact input (DI) is used, always short the contact input (DI) terminals (Nos. 6 and 7). Otherwise, no control can be started by the front key or via communication.

3.2 Terminal Configuration

Conduct wiring by referring to following diagrams.

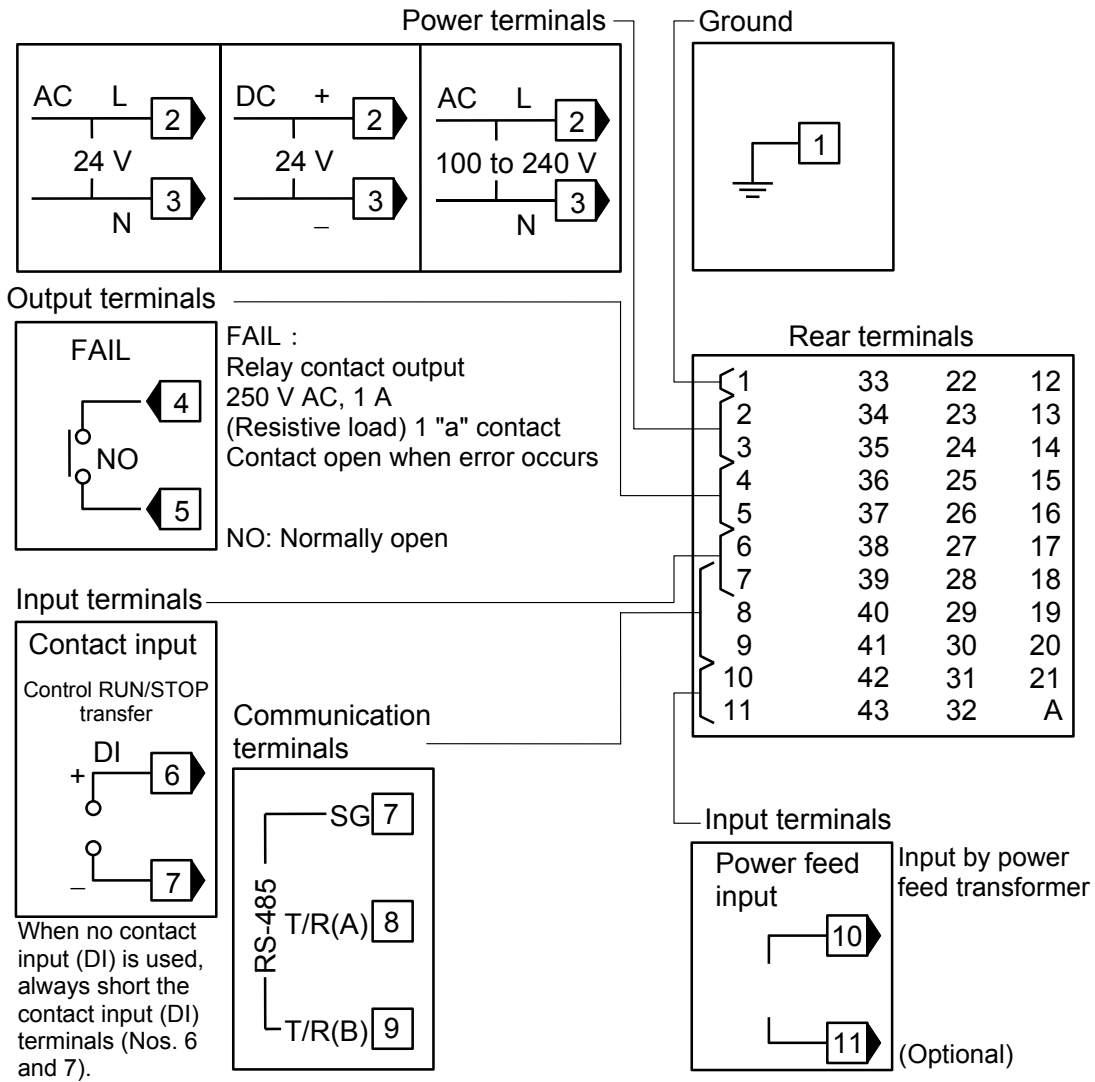

■ Power supply voltage

85 to 264 V AC (50/60 Hz)
 [Including power supply voltage variation]
 (Rating: 100 to 240 V AC)

21.6 to 26.4 V AC (50/60 Hz)
 [Including power supply voltage variation]
 (Rating: 24 V AC)

21.6 to 26.4 V DC
 [Including power supply voltage variation]
 (Rating: 24 V DC)

■ Power consumption

13 VA max. (at 100 V AC)
 19 VA max. (at 240 V AC)
 11 VA max. (at 24 V AC)
 8.16 W [340 mA] max. (at 24 V DC)

■ Contact input

Number of input point: 1 point
 Input type: Dry contact input
 Resistance value judged that the contact opens:
 500 kΩ or more
 Resistance value judged that the contact closed:
 10 Ω or less

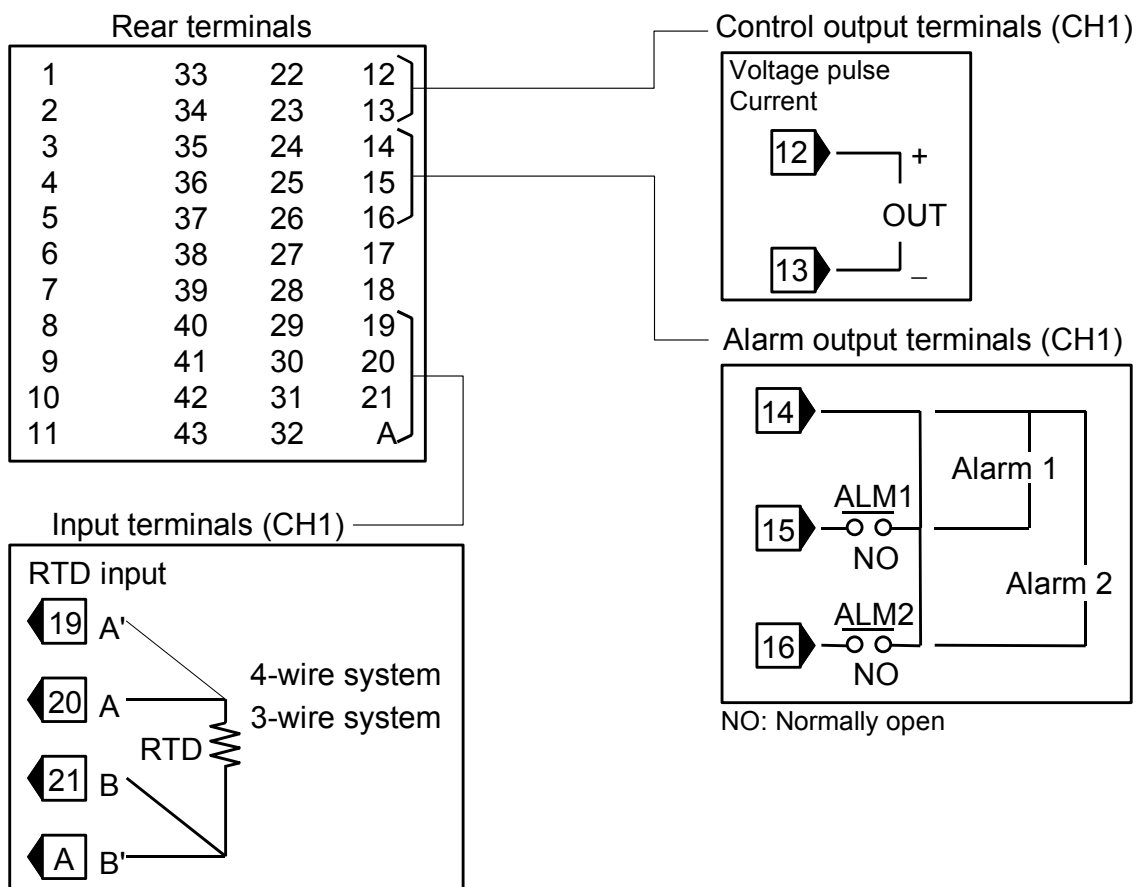

 As input, different types of input (3-wire and 4-wire systems) can be connected to CH1 and CH2.

■ Control output (CH1)

Voltage pulse output:	Output voltage:	0/12 V DC
	Allowable load resistance:	600 Ω or more
Current output:	Output current:	4 to 20 mA DC
	Resolution:	13 bits or more
	Allowable load resistance:	600 Ω or less

■ Alarm output (CH1)

Number of output points:	2 points [Relay contact output 250 V AC, 1 A (Resistive load) 1a contact]
Electrical life :	50,000 times or more (Rated load)

■ Input (CH1)

Input:	RTD input: Pt100 Ω (JIS/IEC), JPt100 Ω Corresponding to the 3- and 4-wire systems.
Influence of input lead:	0.04 $^{\circ}\text{C}$ or less (Per wire: 10 Ω or less)

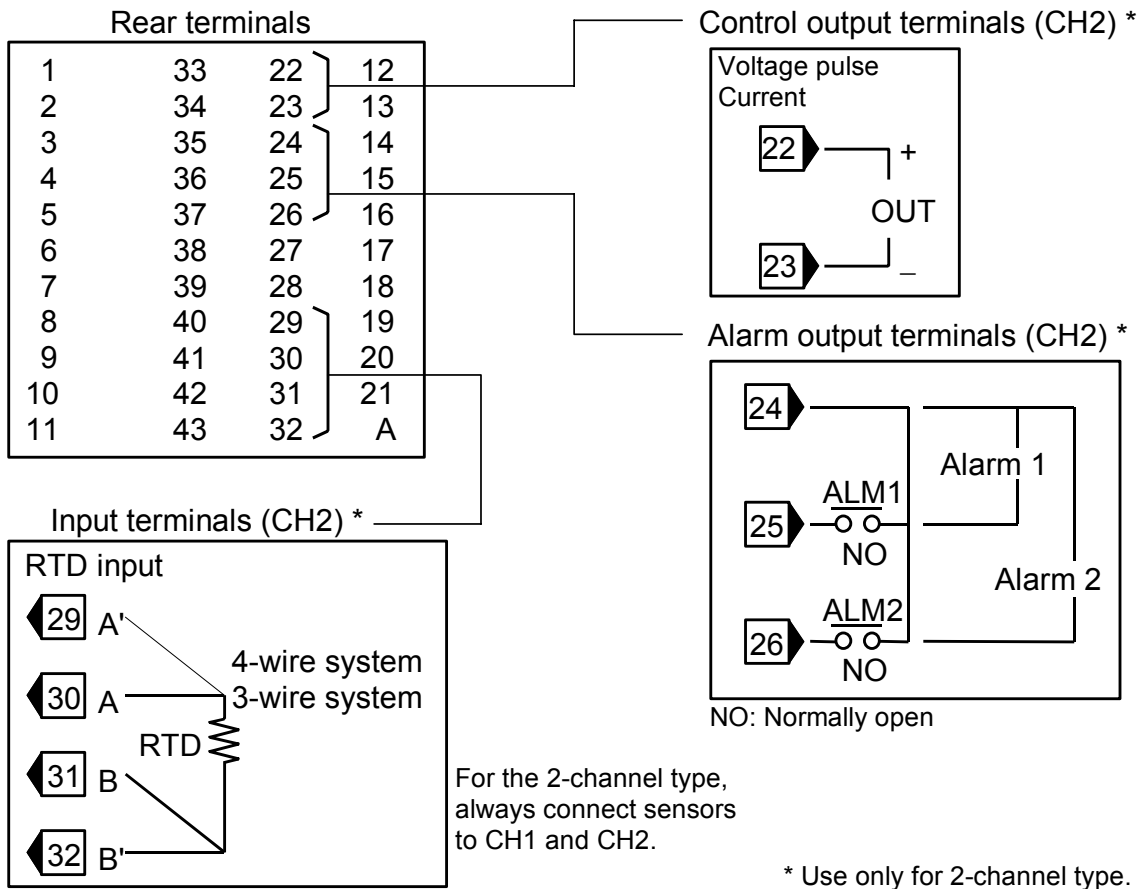

 As input, different types of input (3-wire and 4-wire systems) can be connected to CH1 and CH2.

■ **Control output (CH2)**

Voltage pulse output:	Output voltage:	0/12 V DC
	Allowable load resistance:	600 Ω or more
Current output:	Output current:	4 to 20 mA DC
	Resolution:	13 bits or more
	Allowable load resistance:	600 Ω or less

■ **Alarm output (CH2)**

Number of output points: 2 points [Relay contact output 250 V AC, 1 A (Resistive load) 1a contact]
Electrical life: 50,000 times or more (Rated load)

■ **Input (CH2)**

Input: RTD input: Pt100 Ω (JIS/IEC), JPt100 Ω
Corresponding to the 3- and 4-wire systems.

Influence of input lead: 0.04 °C or less (Per wire: 10 Ω or less)

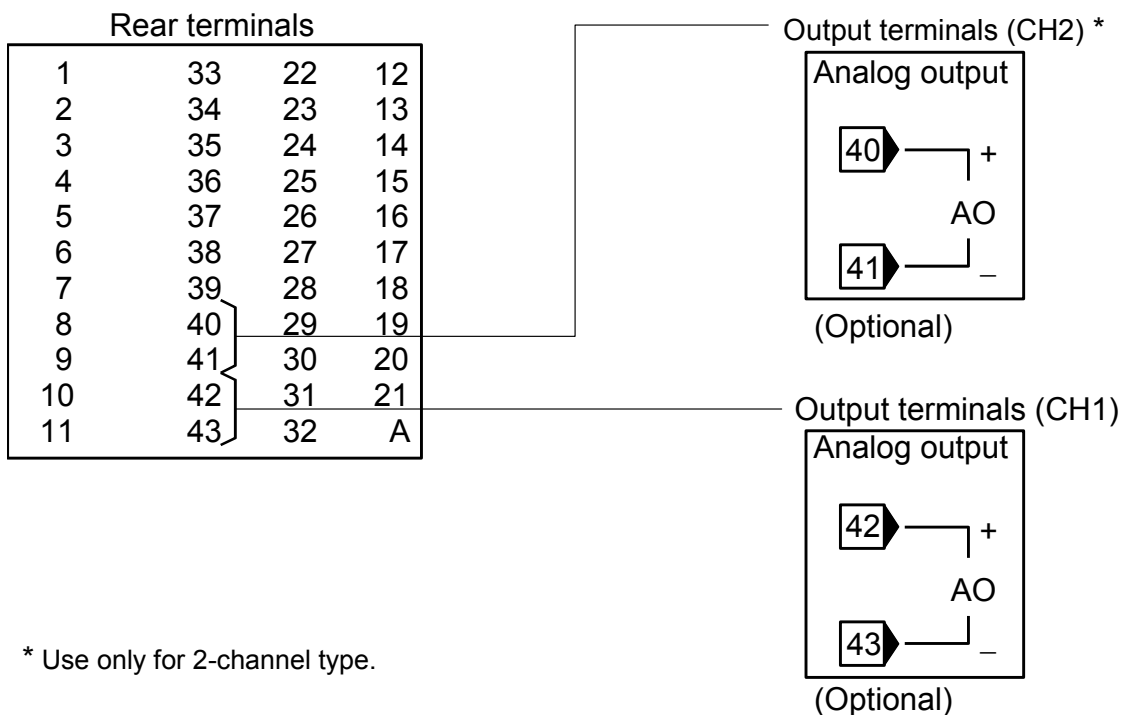

■ Analog output (Optional)

Number of output points: 1 point (1-channel type)
 2 points (2-channel type)

Output types: Voltage output: 0 to 5 V DC, 1 to 5 V DC
 Current input: 0 to 20 mA DC, 4 to 20 mA DC

Allowable load resistance: Voltage output: 1 k Ω or more
 Current input: 600 Ω or less

Output impedance: Voltage output: 0.1 Ω or less
 Current input: 5 MΩ or more

Terminal configuration (Power feed transformer)

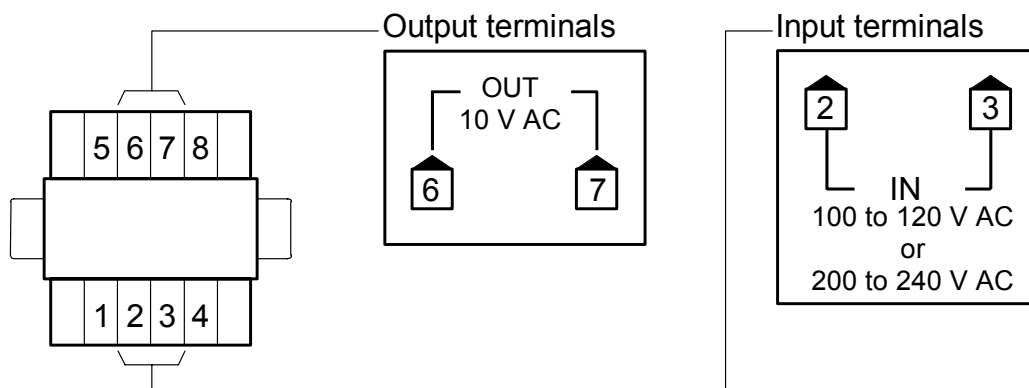

3.3 Wiring Example

■ 1-channel type

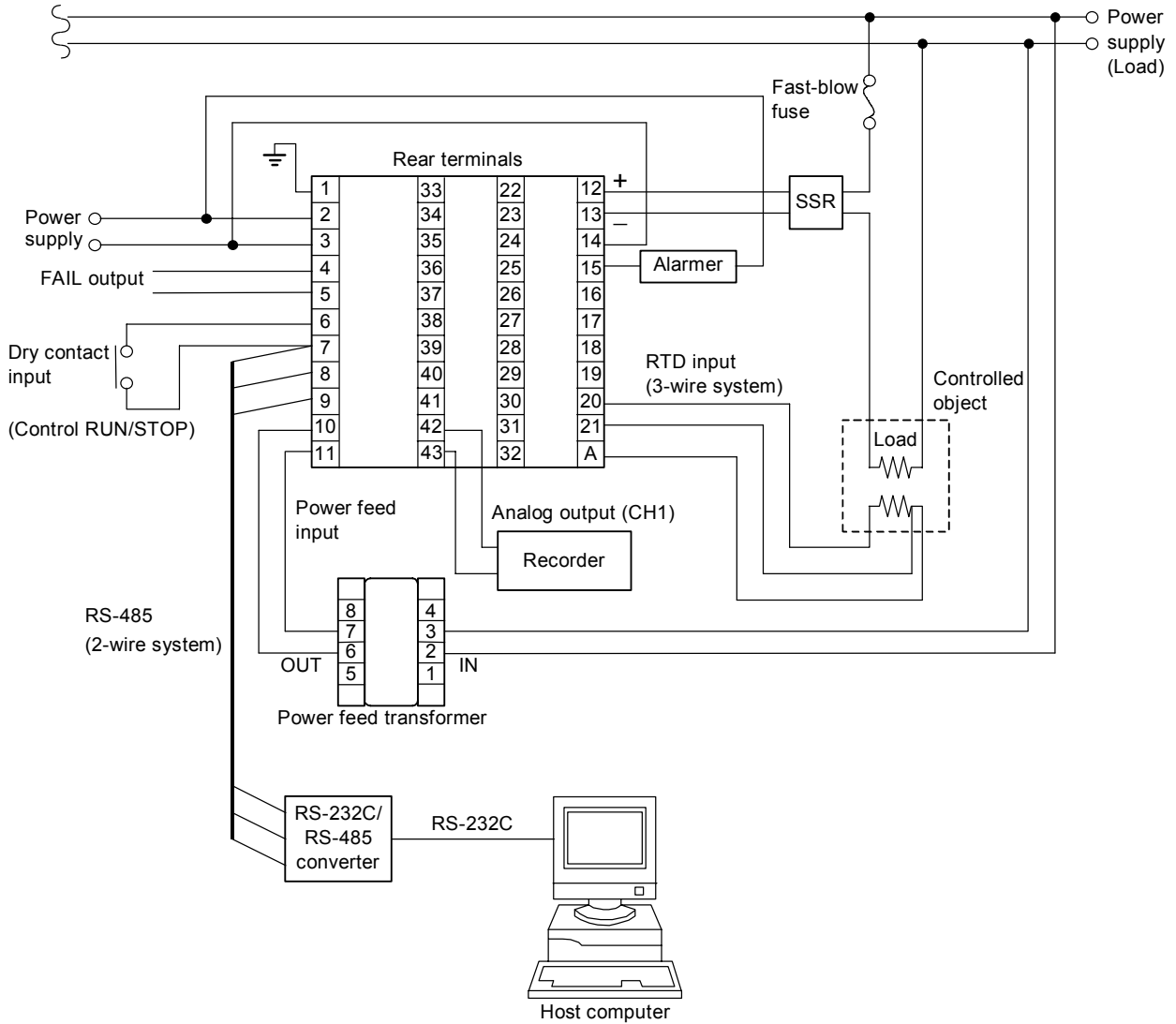

When the host computer is for Windows 95/98/NT, use a RS-232C/RS-485 converter of the automatic send/receive select type.

Recommended: CD485, CD485/V manufactured by Data Link, Inc. or equivalent.

4. NAME OF PARTS

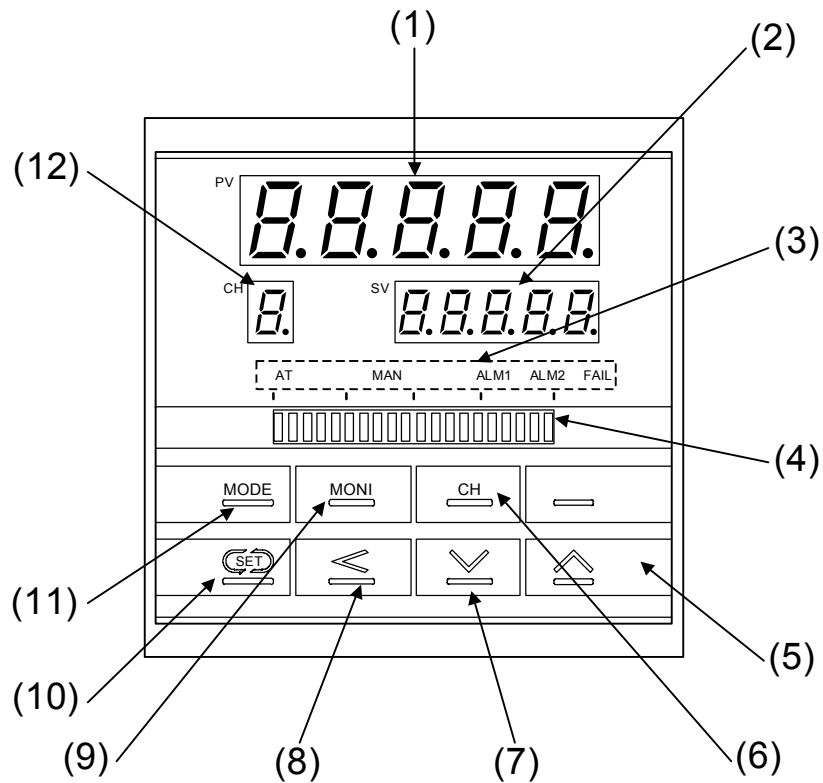

(1) Measured value (PV) display unit [Green]

- Displays measured value (PV).
- Displays various each parameter symbol set value depending on the instrument.

(2) Set value (SV) display unit [Orange]

- For the 2-channel type, measured value (PV) is displayed.
- Displays set value (SV) and various set values.

(3) Indication lamps

- AT (Autotuning lamp) [Green]: Flashes during autotuning execution.
- MAN (Manual lamp) [Green]: Lights in the manual mode.
- ALM1, ALM2 (Alarm lamps) [Red]: ALM1: Lights when alarm 1 output is turned on.
ALM2: Lights when alarm 2 output is turned on.
- FAIL (Failure lamp) [Red]: Lights in the fail status.

(4) Bar-graph display unit

- Manipulated output value (MV) display:

When manipulated output value (MV) becomes 0 % or less, the dot at the left end of the bar-graph only flashes and when it exceeds 100 %, that at the right end flashes.

[Example of display]

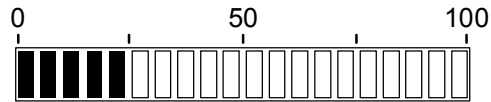

- Deviation display:

The dots at both ends of bar-graph light to indicate deviation display.

[Example of display]

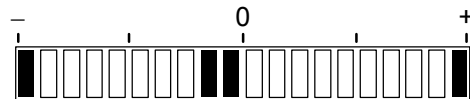

(5)  (Up key)

- Used to increase numerals.
- Mode selection is made.

(6) CH (Channel key)

The selection of CH1 and CH2 is made.

(7)  (Down key)

- Used to decrease numerals.
- Mode selection is made.

(8)  (Shift key)

Used when the cursor (brightly lit) is moved to the digit whose numeric value needs to be changed for set value change.

(9) MONI (Monitoring key)

Used to call up the CH1PV/CH2PV, PV/SV or MV display.

(10)  (Set key)

- Used for parameter registration/calling up.
- Used to call up "SV setting mode," "Operator set mode" or "Setup mode."

(11) MODE (Mode key)

- Used to call up "Mode transfer."
- Used to select "PID/Autotuning transfer," "Control RUN/STOP," "AUTO/MANUAL" or "Set data lock."

(12) Channel (CH) display unit

- Displays the channel Number being used.
- For the 2-channel type and CH1PV/CH2PV display, nothing is displayed.

5. SETTING

5.1 Calling-Up Procedure of Monitor and Each Mode

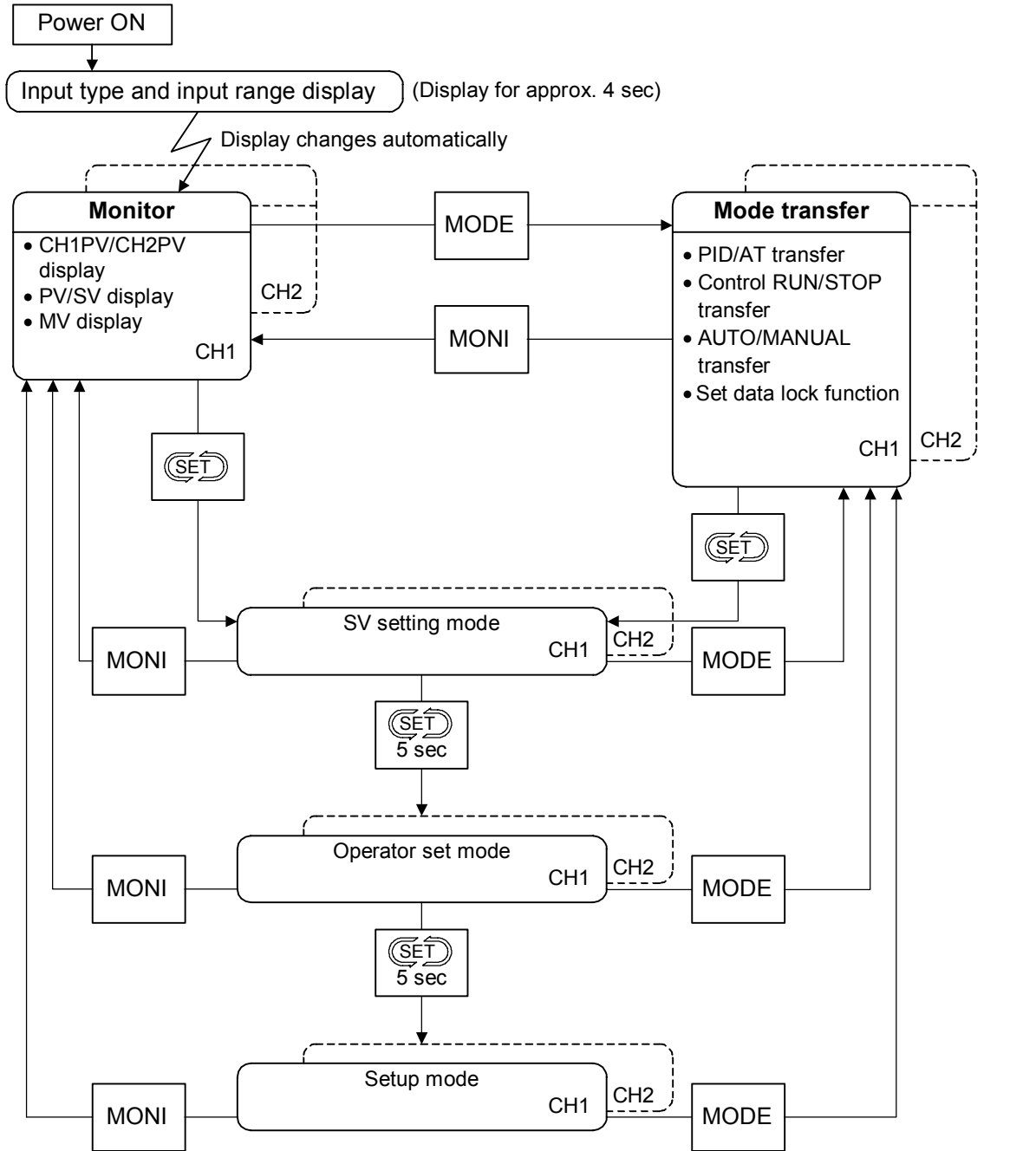

MONI : Press the MONI key.

SET : Press the SET key.

⎓ : For the instrument of 2-channel type, pressing the CH key changes the present screen to the CH2 screen.

MODE : Press the MODE key.

SET 5 sec : Press the SET key for more than 5 sec.



When using this instrument for the first time after its purchase, first set the parameters in "5.6 Setup Mode" (P. 30).

■ Input type/input range display

This instrument immediately confirms input type and range following power-ON.

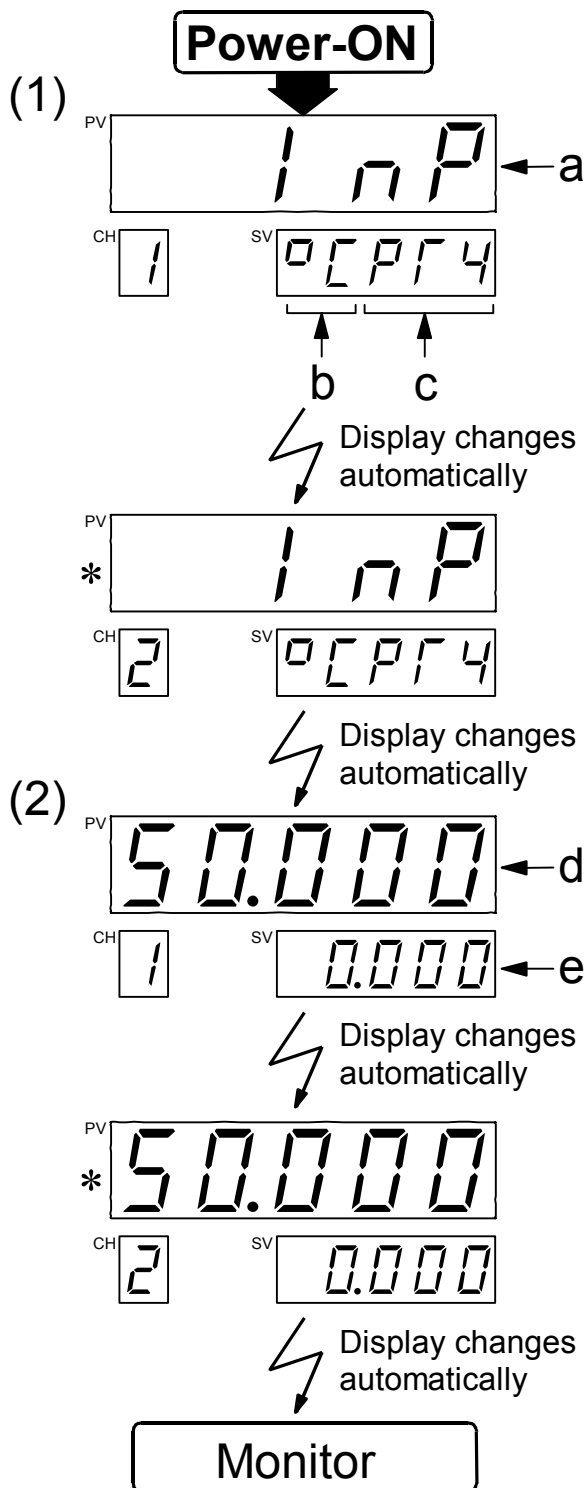

(1) Input type display

a: Input display parameter symbol (Inp)

b: Engineering unit ($^{\circ}\text{C}$)

c: Input type:

$P\Gamma 3$: Pt100 Ω (3-wire system)

$J\text{P}3$: JPt100 Ω (3-wire system)

$P\Gamma 4$: Pt100 Ω (4-wire system)

$J\text{P}4$: JPt100 Ω (4-wire system)

(2) Input range display

d: Setting limiter [high limit]
(Input range high)

e: Setting limiter [low limit]
(Input range low)

* Display only for 2-channel type.

5.2 Monitor

The monitor unit monitors the measured value (PV) and set value (SV), and also monitors and changes the manipulated output value (MV).

The display in the monitor unit is selected by pressing the MONI key.

(1) Display sequence

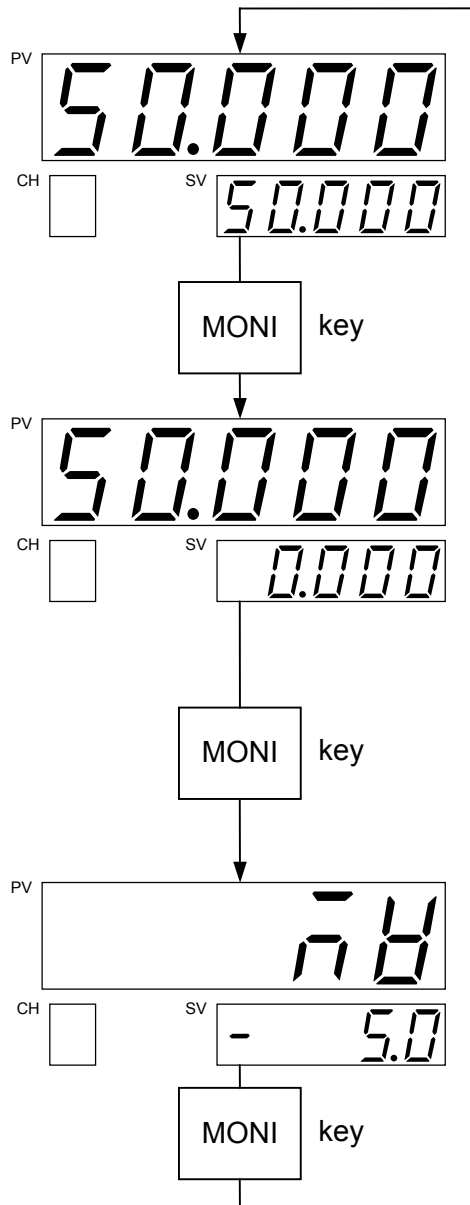

CH1PV/CH2PV display

The PV display unit shows measured value (PV) in CH1, while the SV display unit shows measured value (PV) in CH2.

The channel display unit does not show anything during CH1PV/CH2PV display.

PV/SV display

Display measured value (PV) on the PV display unit and set value (SV) on the SV display unit.

In addition, the manipulated output value (MV) can be manually (MANUAL) set in manual mode. The manipulated output value (MV) is displayed on the SV display unit.

For the 2-channel type, make confirmation with CH2 selected by pressing the channel (CH) key.

MV display

The PV display unit shows the parameter symbol (MV), and the SV display unit shows the manipulated output value (MV).

For the 2-channel type, make set with CH2 selected by pressing the channel (CH) key.

Usually the control is set to this monitor excepting that the set value (SV) and/or the parameter set value are changed.

For the 1-channel type, pressing the MONI key in MV display mode changes to the PV/SV display.

(2) Procedure for setting the manipulated output value (MV) in MAN mode

Manipulated output value (MV) in the manual (MAN) mode can be manually set in the PV/SV display.

- ☞ The manipulated output value (MV) is changed after "MANUAL" is selected by "AUTO/MANUAL transfer" for mode transfer. (Refer to P. 20)

[Example]

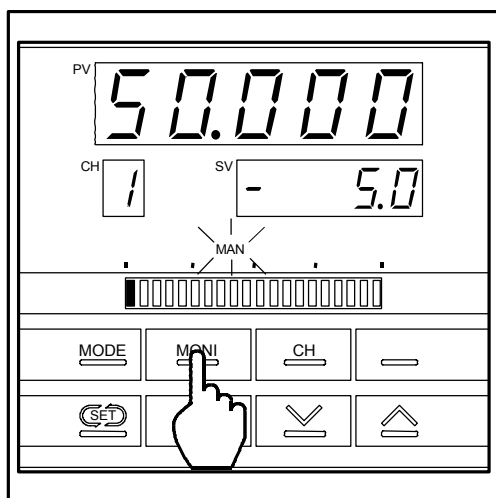

PV/SV display

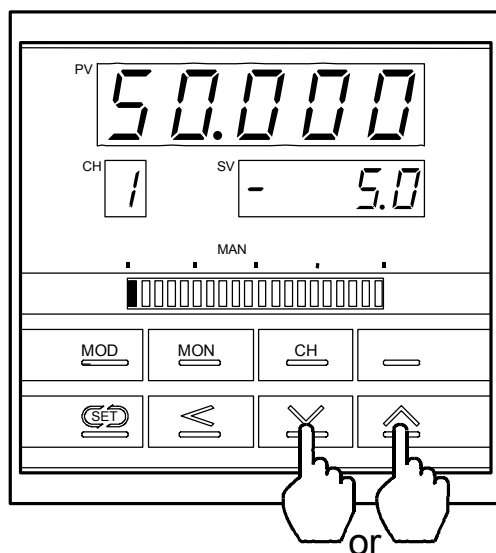

1. Set the instrument to PV/SV display

If the instrument is set to another mode, press the MONI key to set the instrument to the PV/SV display. At this time, the MAN lamp lights.

- ☞ For the details of PV/SV display selection, refer to "5.1 Calling-Up Procedure of Monitor and Each Mode."

2. Manipulated set value (MV) change

Pressing the UP key increases the manipulated output value on the SV display unit, and pressing the DOWN key decreases the value.

Setting range: -5.0 to $+105.0$ %

- ☞ Keeping pressing the DOWN or UP key makes numeric value change faster.

5.3 Mode Transfer

"Mode transfer" is used to change PID/AT, control RUN/STOP or AUTO/MANUAL or to set the set data lock. Display in the mode transfer is changed by the MODE key.



If the 2-channel type, select the mode or data lock for every channel.

[However, with the exception of control RUN/STOP by contact input (DI)]

Select CH2 and then select the desired mode.

(1) Display sequence

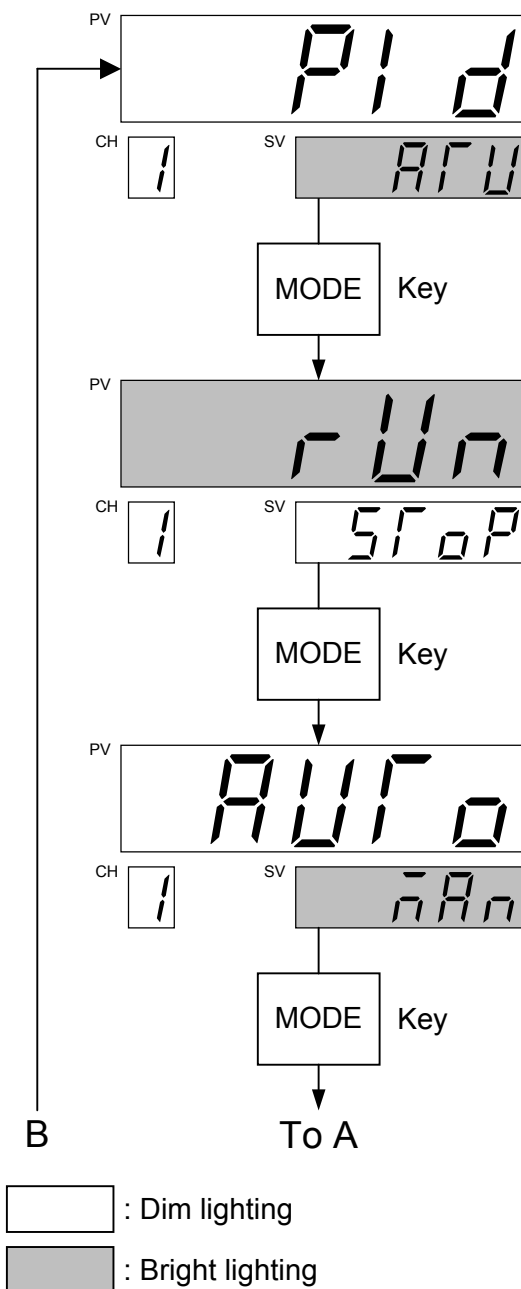

PID/AT transfer

PID control or autotuning (AT) is selected by pressing the UP/DOWN keys.

(The figure at left shows the PID control.)



If the autotuning (AT) is executed, the AT lamp flashes.

Control RUN/STOP transfer

Selected when control is either executed (RUN) or stopped (STOP).

(The figure at left shows the STOP.)

AUTO/MANUAL transfer

Selected when control is performed in either the automatic or manual mode.

(The figure at left shows the AUTO.)



For the details of manual operation, refer to "(2) Procedure for setting manipulated output value (MV) in MAN mode" (P. 19).

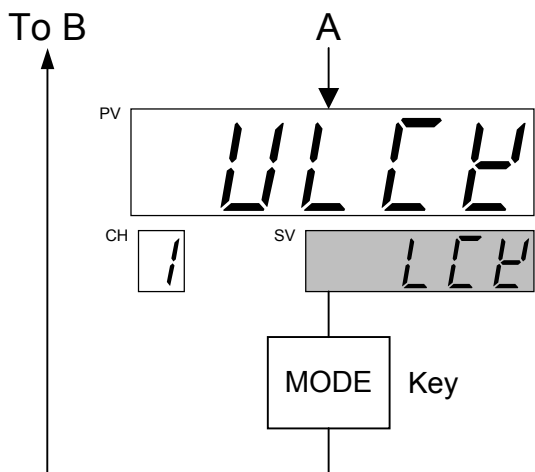

Set data lock function

Selected when either the set data lock function is invalidated (unlock) or validated (lock). (The figure at left shows the unlock.)

☞ For details on set data lock, refer to "5.6 Setup Mode" (P. 30).

- : Dim lighting
- : Bright lighting

- 📖 **If mode transfer is disabled by locking the set data (PG40) in setup mode, no mode transfer is made by the front key. However, even if mode transfer is disabled, control RUN/STOP can be made by the contact input.**
- 📖 For the 1-channel type, if the key is not operated for within 1 minute, the present display automatically returns to the PV/SV display.
- 📖 For the 2-channel type, if the key is not operated for within 1 minute, the present display automatically returns to the CH1PV/CH2PV display.

(2) Transfer to mode

[Example] When operation is changed from execution (RUN) to STOP.

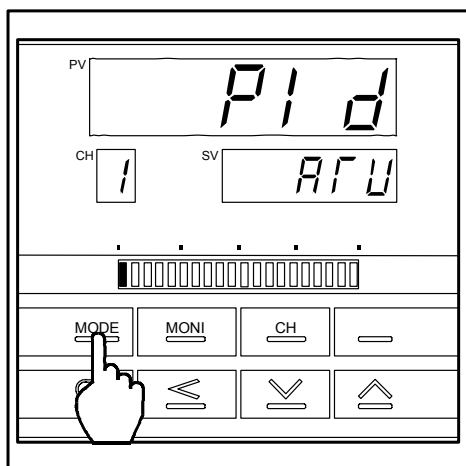

PID/AT transfer

1. Press the MODE key to set the instrument to the "Mode transfer." First, "PID/AT transfer" is displayed.

☞ For the details of "Mode transfer" selection, refer to "5.1 Calling-Up Procedure of Monitor and Each Mode."

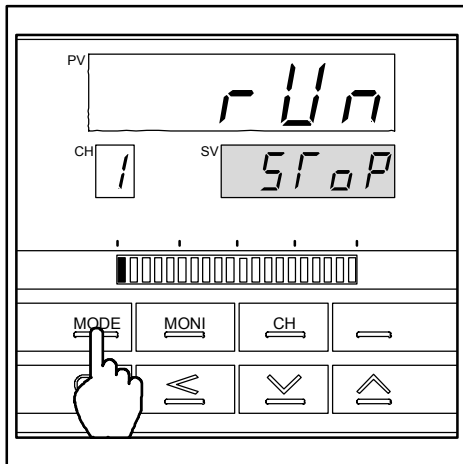

Control RUN/STOP transfer

2. Press the MODE key to display "Control RUN/STOP transfer."
The display selected is brightly lit.

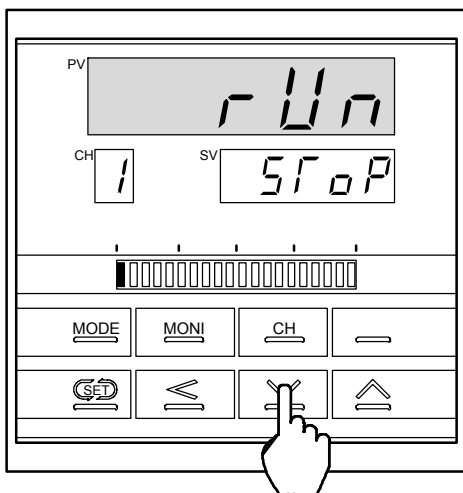

3. Press the DOWN key to change the instrument from RUN to STOP. For mode transfer, mode transfer becomes valid at this time.

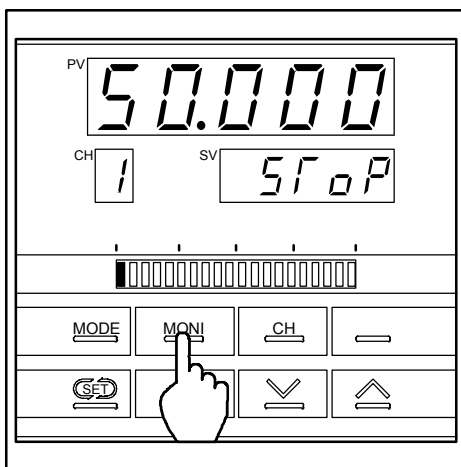

PV/SV display

4. After the above transfer is finished, press any key of MONI and MODE to set the instrument to the desired status.
(The figure at left shows the PV/SV display.)







The transfer of other modes is also the same. Select the desired mode, then change to that mode.

(3) Control RUN/STOP transfer by contact input

The control RUN/STOP can be transferred according to the open/close status of the contact input (DI). The control RUN/STOP transfer status by contact input is shown in the following.

The contact state during control RUN/STOP transfer

	Front key selection	Communication selection	Status of contact (Terminal Nos.6, 7)	Actual control mode
Control RUN/STOP	RUN	RUN	Closed	RUN
			Open	STOP
	STOP	STOP	Closed	
			Open	

-  **If control is stopped (STOP) by the front key, it is not started (RUN) even in the contact is closed.**
-  **When no contact input (DI) is used, always short the contact input (DI) terminals (Nos. 6 and 7). Otherwise, no control can be started by the front key or via communication.**
-  In this instrument, the control RUN/STOP is transferred approx. 1 sec after the contact input (DI) open/close status is changed.
-  The RUN/STOP cannot be selected for every channel when the RUN/STOP is selected by contact input (DI). Both CH1 and CH2 are simultaneously selected.

5.4 SV Setting Mode

The SV setting mode is used to set the temperature set value (SV) which is the target value for control.

■ Setting change procedure

 If the set data is locked, no SV setting mode is displayed.

[Example] When the set value (SV) is change to 20.000 °C

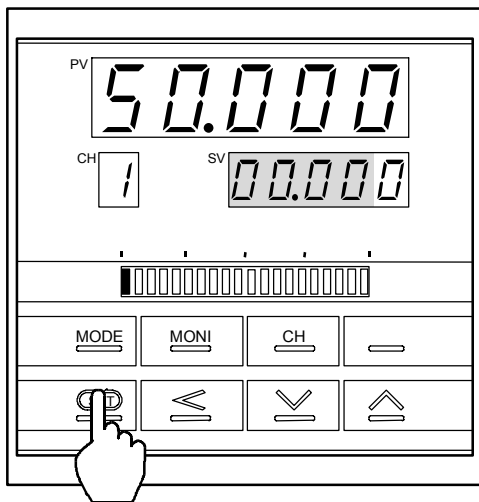

SV setting mode

1. Press the SET key to set the instrument to the "SV setting mode."

Display measured value (PV) on the PV display unit and set value (SV) on the SV display unit.

Setting range:

Setting limiter (low) to setting limiter (high)

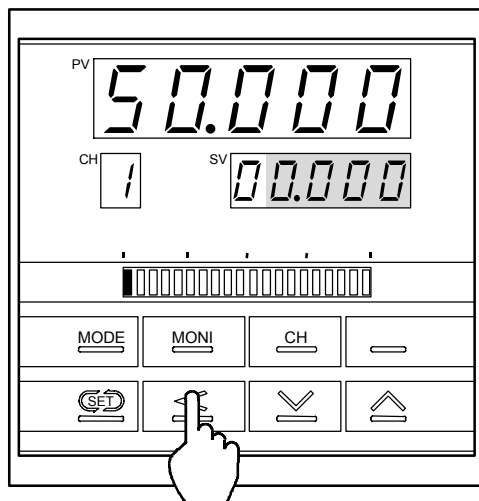

2. Press the SHIFT key to move the brightly lit digit up to the most significant digit. Every time are SHIFT key is pressed, each brightly lit digit moves as follows.

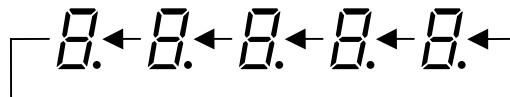

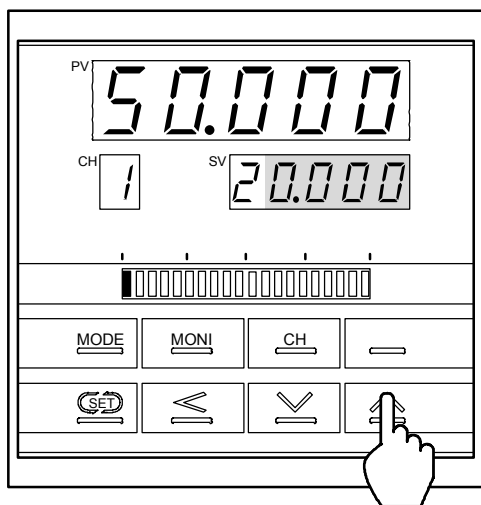

3. Press the UP key to set "2."

Pressing the UP key increments numeric value, and pressing the DOWN key decrements the value.

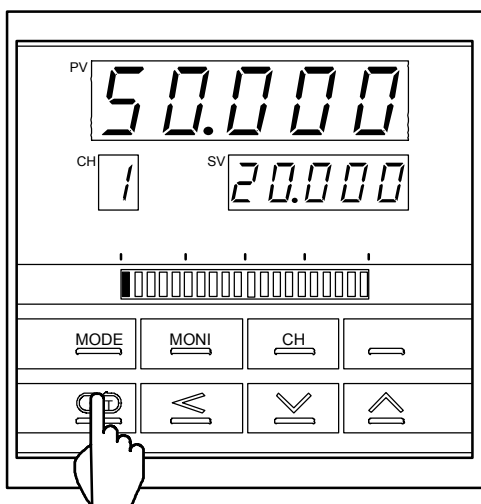

4. Pressing the SET key registers the value thus set. (The present screen is changed to the PV/SV display.)

Monitor (PV/SV display)



For the 1-channel type, if the key is not operated for within 1 minute, the present display automatically returns to the PV/SV display.



For the 2-channel type, if the key is not operated for within 1 minute, the present display automatically returns to the CH1PV/CH2PV display.



If the 2-channel type, set value (SV) can be set for every channel.

5.5 Operator Set Mode

The operator set mode is used to set various parameters for alarm set values and control. The display within operator set mode is changed by pressing the SET key.

 If the 2-channel type, parameter can be set for every channel. Select CH2 and then select the desired mode.

(1) Display sequence

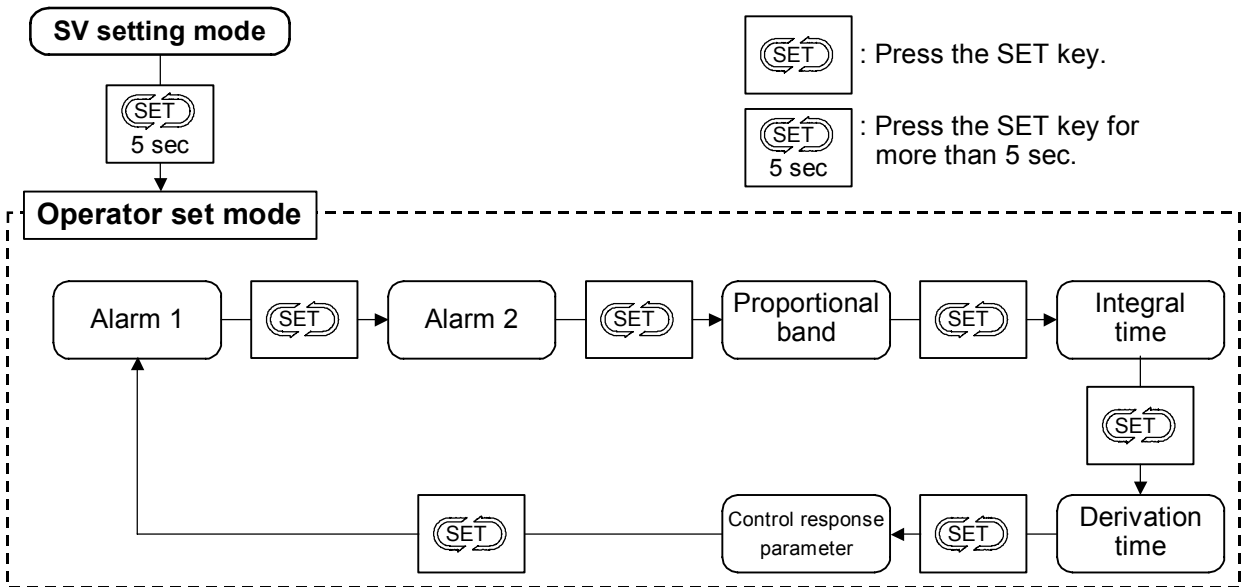

(2) Description of each parameter

Parameter list

#1: Factory set value

Symbol	Name	Setting range	Description	#1
<i>AL1</i> (AL1)	Alarm 1 setting ¹	Process alarm: 0.000 to 50.000 °C Deviation alarm: -19.999 to +19.999 °C	Set the alarm 1 set value.	5.000
<i>AL2</i> (AL2)	Alarm 2 setting ²		Set the alarm 2 set value.	
<i>P</i> (P)	Proportional band	0.001 to 50.000 °C *0.000 cannot be set.	The proportional band for PI or PID control is set.	30.000
<i>I</i> (I)	Integral time	0.1 to 3600.0 sec *0.0 cannot be set.	Eliminates offset occurring in proportional control.	240.0
<i>d</i> (d)	Derivative time	0.0 to 3600.0 sec 0.0 sec: Derivative action OFF	Prevents ripples by predicting output change, thereby improving control stability.	60.0

¹ If there is no alarm 1, "-----" is displayed.

² If there is no alarm 2, "-----" is displayed.



Continued on the next page.

Continued from the previous page.

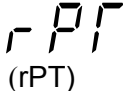
#1: Factory set value

Symbol	Name	Setting range	Description	#1
 (rPT)	Control response parameter	0: Slow 1: Medium 2: Fast	Response required due to set-point change in PID action is performed.	0

(3) Procedure for setting each parameter

-  For this instrument, the numeric value is not registered if it is only change by the UP/DOWN keys.
-  If the set data is lock, all of the digits on the SV display unit are brightly lit and the set value cannot be changed.

[Example] When the alarm 2 (AL2) is changed to 50.000 °C

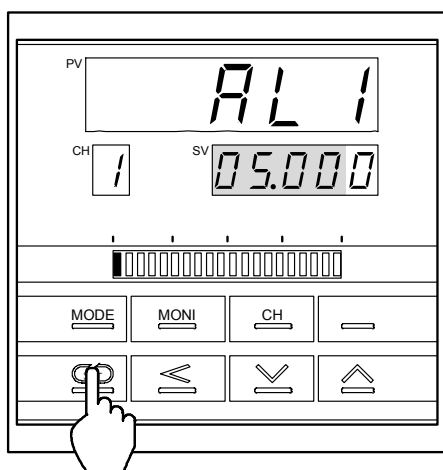

Alarm 1 (ALM1) setting

1. Press the SET key for more than 5 sec to set the instrument to operator set mode. Operator set mode is selected, "Alarm 1 (AL1) setting" is displayed first.

 For the details of operator set mode selection, refer to "5.1 Calling-Up Procedure of Monitor and Each Mode."

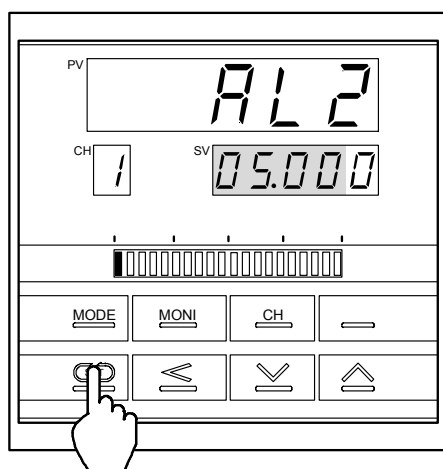

Alarm 2 (AL2) setting

2. Press the SET key to set the instrument to the alarm 2 setting.

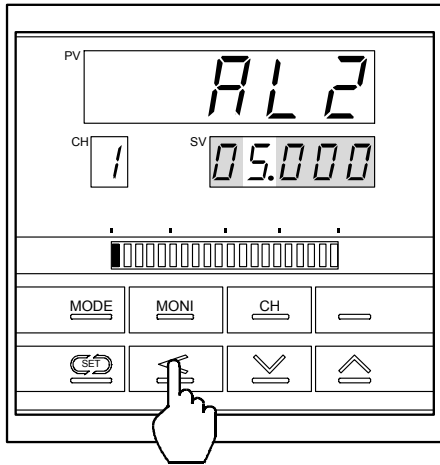

3. Press the SHIFT key to brightly light the units digit.

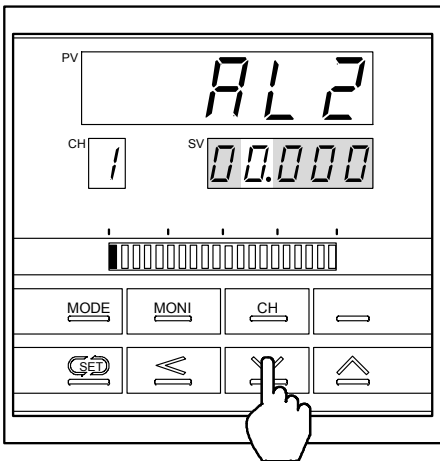

4. Press the DOWN key to enter "0" in the units digit.

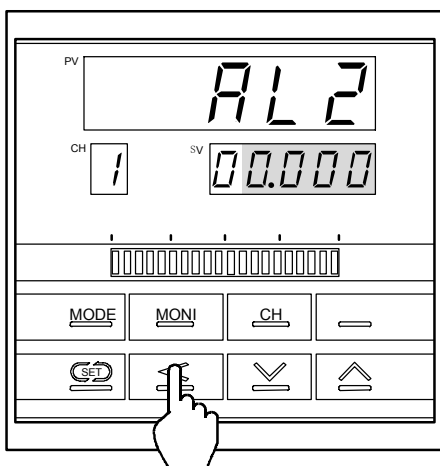

5. Press the SHIFT key to move the brightly lit digit up to the most significant digit.

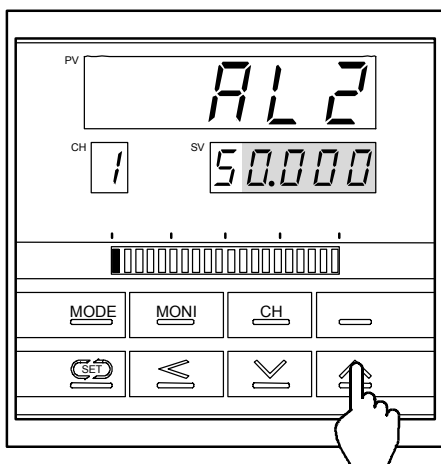

6. Press the UP key to enter "5" in the significant digit.

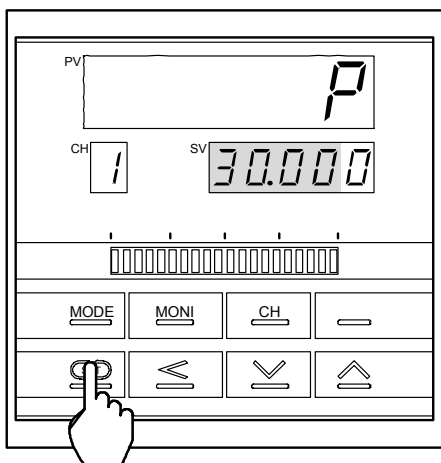

7. After the displayed value is changed, press the SET key.
(The present display changes to the proportional band display.)

Proportional band



For the 1-channel type, if the key is not operated for within 1 minute, the present display automatically returns to the PV/SV display.



For the 2-channel type, if the key is not operated for within 1 minute, the present display automatically returns to the CH1PV/CH2PV display.

5.6 Setup Mode

The setup mode is used to set some specific specifications (input type, input range, alarm type, etc.) and characteristics (setting limiter, alarm differential gap, etc.) of this instrument.

(1) Display sequence

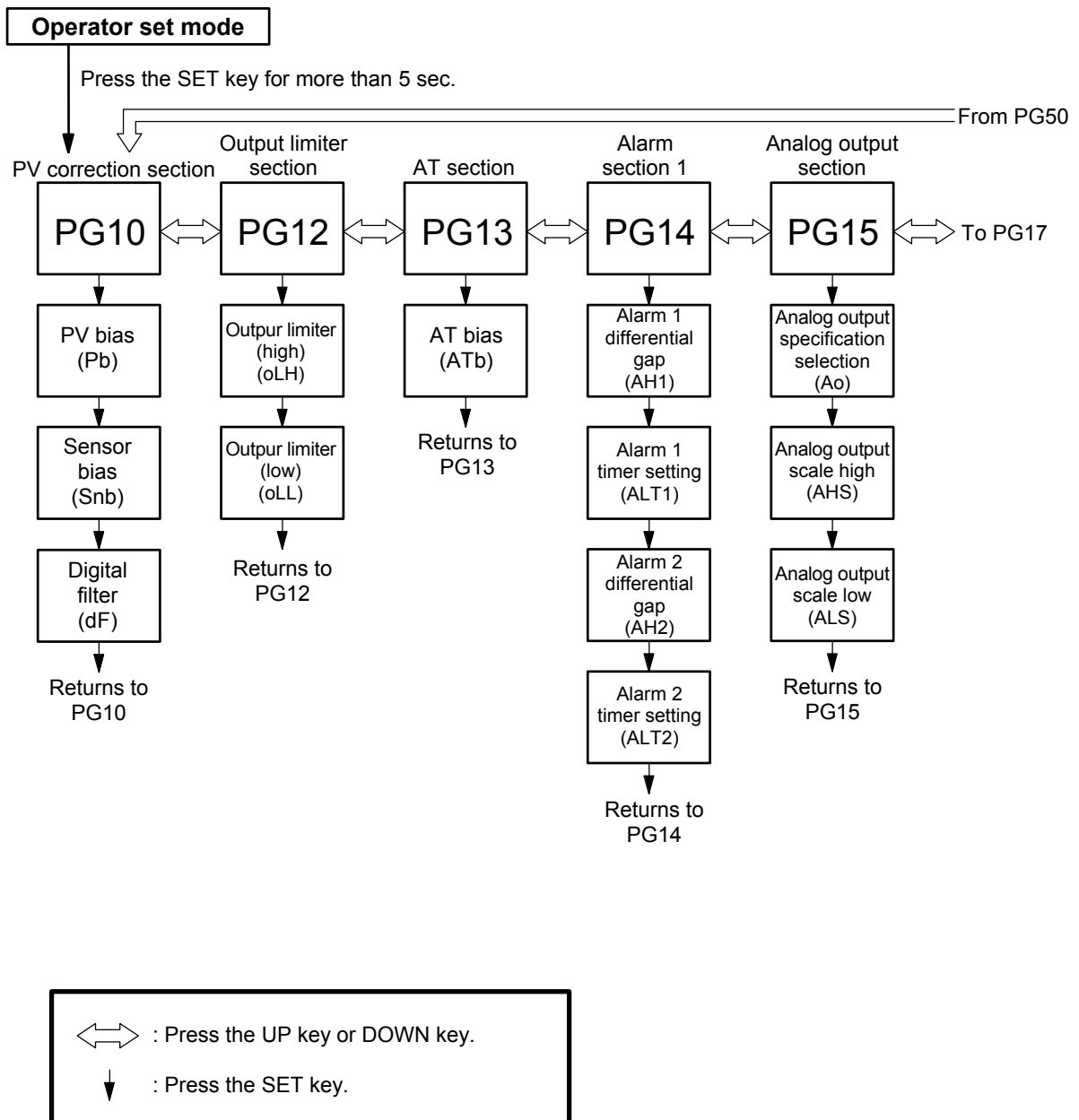

PG: Means Parameter Group

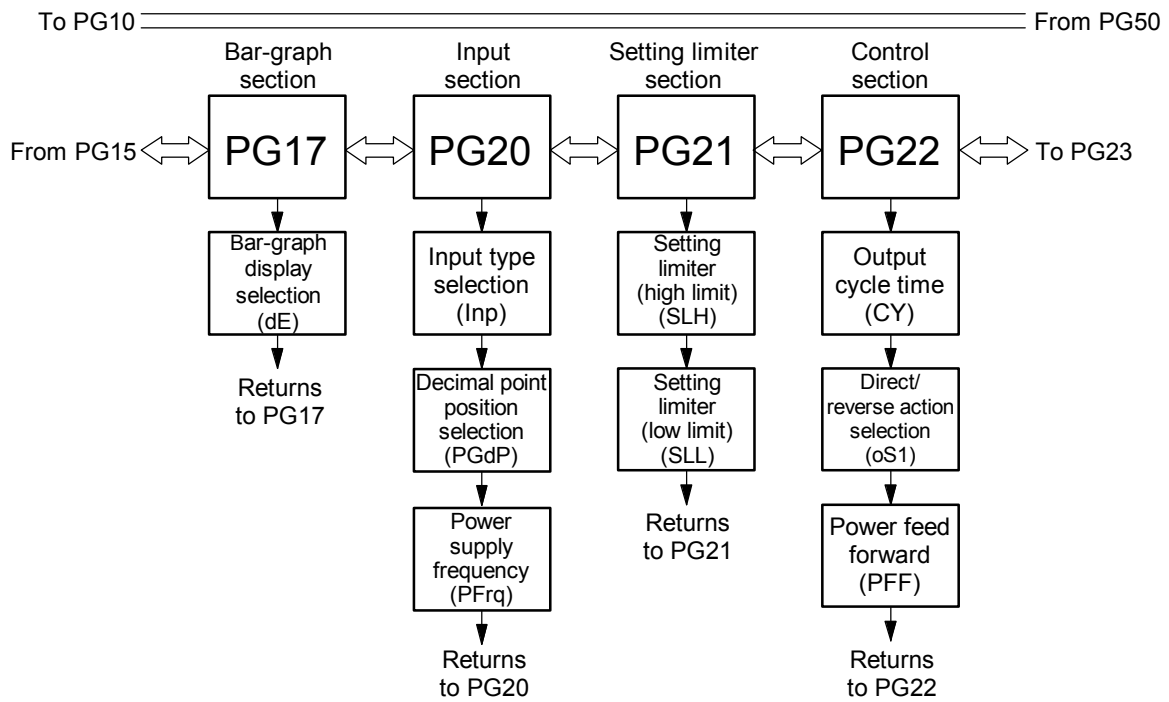

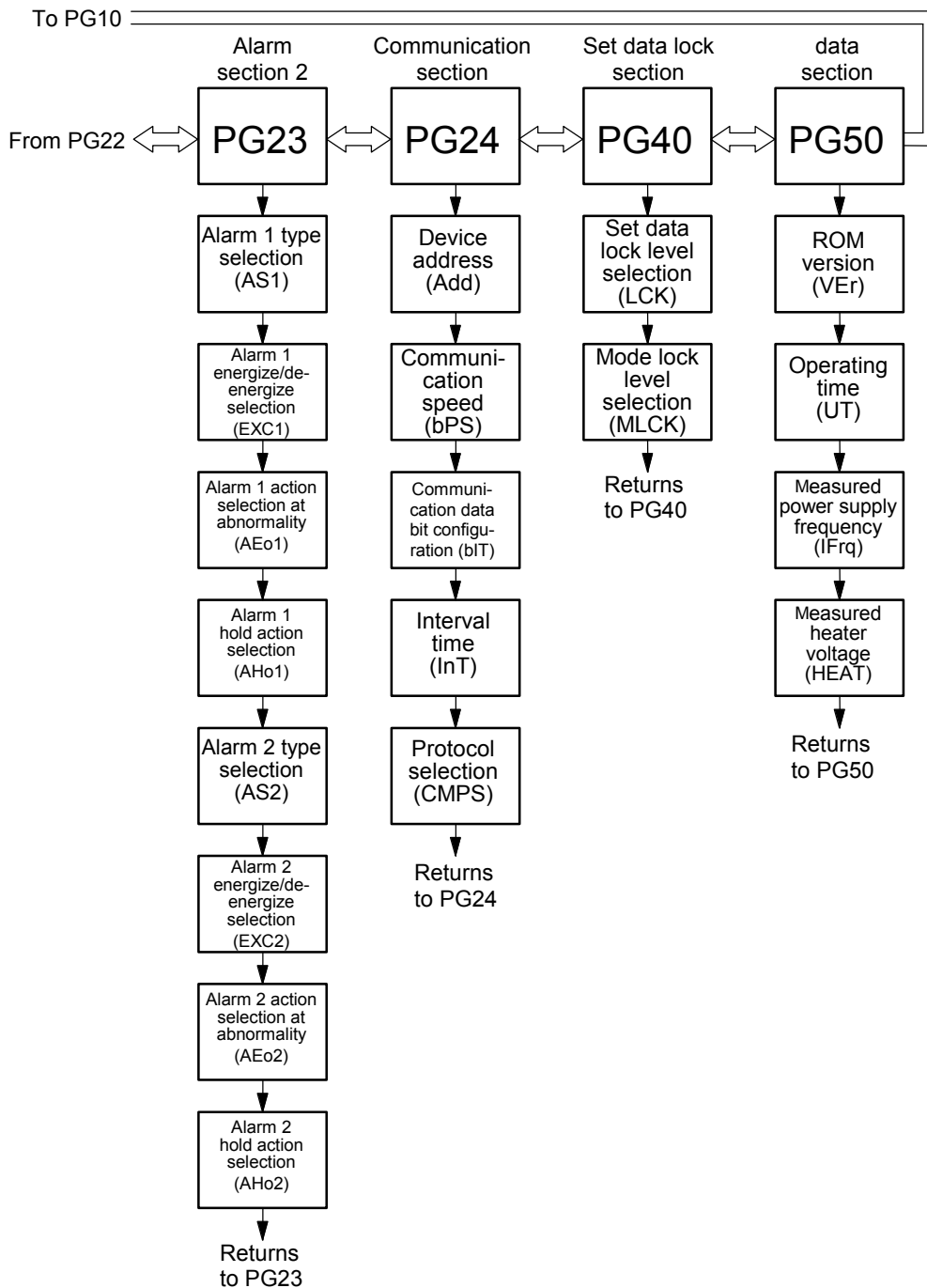

(2) Description of each parameter

If the 2-channel type, parameter can be set for every channel. Select CH2 and then select the desired mode.

PV correction section [PG10]

#1: Factory set value

Symbol	Name	Setting range	Description	#1
<i>PG 10</i> (PG10)	Parameter group 10	—	The first characters of parameter group PG10.	—
<i>Pb</i> (Pb)	PV bias	-19.999 to +19.999 °C	Sensor correction is made by adding bias value to measured value (PV).	0.000
<i>Snb</i> (Snb)	Sensor bias	-1.9999 to +1.9999 Ω	Enter the value obtained by subtracting sensor calibration data from the sensor true value. ¹	0.0000
<i>df</i> (dF)	Digital filter	0.0 to 100.0 sec 0.0: Digital filter OFF	Noise in measured value (PV) input is reduced by the employment of first-order lag filter.	0.0

¹For details, refer to "9. 5 Sensor Bias Function."

Output limiter section [PG12]

#1: Factory set value

Symbol	Name	Setting range	Description	#1
<i>PG 12</i> (PG12)	Parameter group 12	—	The first characters of parameter group PG12.	—
<i>oLH</i> (oLH)	Output limiter (high)	Output limiter (low) to 105.0 %	High limit of manipulated output value (MV).	100.0
<i>oLL</i> (oLL)	Output limiter (low)	-5.0 % to output limiter (high)	Low limit of manipulated output value (MV).	0.0

AT section [PG13]

#1: Factory set value

Symbol	Name	Setting range	Description	#1
PG 13 (PG13)	Parameter group 13	—	The first characters of parameter group PG13.	—
ATb (ATb)	AT bias	-19.999 to +19.999 °C	Adds bias to set value (SV) when autotuning (AT) is performed.	0.000

Alarm section 1 [PG14]

#1: Factory set value

Symbol	Name	Setting range	Description	#1
PG 14 (PG14)	Parameter group 14	—	The first characters of parameter group PG14.	—
AH1 (AH1)	Alarm 1 differential gap ¹	0.000 to 5.000 °C	Sets alarm 1 differential gap.	2.000
ALT1 (ALT1)	Alarm 1 timer setting ¹	0 to 600 sec	Sets time until alarm is turned ON after measured value (PV) enters alarm 1 area.	0
AH2 (AH2)	Alarm 2 differential gap ²	0.000 to 5.000 °C	Sets alarm 2 differential gap.	2.000
ALT2 (ALT2)	Alarm 2 timer setting ²	0 to 600 sec	Sets time until alarm is turned ON after measured value (PV) enters alarm 2 area.	0

¹ If there is no alarm 1, "-----" is displayed.² If there is no alarm 2, "-----" is displayed.

Analog output section [PG15]

#1: Factory set value

Symbol	Name	Setting range	Description	#1
PG15 (PG15)	Parameter group 15	—	The first characters of parameter group PG15.	—
AO (Ao)	Analog output specification selection *	0: Measured value (PV) 1: Deviation (DEV) 2: Set value (SV) 4: Manipulated output value (MV) Do not set "3."	Sets analog output type.	0
AHS (AHS)	Analog output scale high *	The analog output scale (AHS/ALS) differs depending on the analog output specification (Ao). Refer to Table 1 .	Sets high limit of analog output range.	50.000
ALS (ALS)	Analog output scale low *		Sets low limit of analog output range.	0.000

* If there is no analog output, "-----" is displayed.

Table 1

Analog output specification	Analog output scale range
0: When measured value (PV) is selected.	0.000 to 50.000 °C
1: When deviation (DEV) is selected.	-19.999 to +19.999 °C
2: When set value (SV) is selected.	0.000 to 50.000 °C
3: When manipulated output (MV) is selected.	-5.0 to +105.0 %

Bar-graph section [PG17]

#1: Factory set value

Symbol	Name	Setting range	Description	#1
PG17 (PG17)	Parameter group 17	—	The first characters of parameter group PG17.	—
dE (dE)	Bar-graph display selection	0: Manipulated output (MV) * 1: Deviation (DEV) [0.01 °C/dot] 2: Deviation (DEV) [0.1 °C/dot]	Selects the details of bar-graph display.	0

* For manipulated output value (MV) display: 5 % bar-graph dot

Input section [PG20]



The setting of parameter group 20 (PG20) can be changed only in the control stop state.

#1: Factory set value

Symbol	Name	Setting range	Description	#1
PG20 (PG20)	Parameter group 20	—	The first characters of parameter group PG20.	—
InP (Inp)	Input type selection	0: Pt100 Ω (3-wire system) 1: Pt100 Ω (4-wire system) 2: JPt100 Ω (3-wire system) 3: JPt100 Ω (4-wire system)	Can change measured value (PV) input type.	0
PGdP (PGdP)	Decimal point position selection	0: No digit below decimal-point 1: 1 digit below decimal-point 2: 2 digits below decimal-point 3: 3 digits below decimal-point	Set the position of the decimal point for the measured value to be displayed.	3
PFrQ (PFrq)	Power supply frequency	0: 50 Hz 1: 60 Hz 2: Auto setting *	The power supply frequency to reject normal mode noise contained in the input is set.	0

* Set the automatic setting when the power feed forward function is used.

When no power feed input is used, set the desired power frequency (0: 50 Hz or 1: 60 Hz).



When "2: Auto setting" is selected, control stops under the following condition. However, no "STOP" is displayed on the SV display unit.

- When no power feed input is used (no power feed transformer is connected)
- When power feed input voltage becomes less than 30 % of rated value

Setting limiter section [PG21]



The setting of parameter group 21 (PG21) can be changed only in the control stop state.

#1: Factory set value

Symbol	Name	Setting range	Description	#1
PG21 (PG21)	Parameter group 21	—	The first characters of parameter group PG21.	—
SLH (SLH)	Setting limiter (high limit)	Setting limiter (low limit) to 50.000 °C	Sets high limit of setting range (input range).	50.000
SLL (SLL)	Setting limiter (low limit)	0.000 °C to Setting limiter (high limit)	Sets low limit of setting range (input range).	0.000

Control section [PG22]



The setting of parameter group 22 (PG22) can be changed only in the control stop state.

#1: Factory set value

Symbol	Name	Setting range	Description	#1
PG22 (PG22)	Parameter group 22	—	The first characters of parameter group PG22.	—
LY (CY)	Output cycle time	0.1 to 100.0 sec	Sets control output cycle.	0.1
oS1 (oS1)	Direct/reverse action selection	0: Direct action 1: Reverse action	Selects direct or reverse control action.	1
PFF (PFF)	Power feed forward	0: OFF * 1: ON	Selects power feed forward function ON/OFF.	1

* When the power feed forward function is used, the power feed input is required from the power feed transformer. When no power feed input is used, always set the power feed forward function to "0: OFF."



When the power feed forward function is set to "1: ON," control stops under the following condition. However, no "STOP" is displayed on the SV display unit.

- When no power feed input is used (no power feed transformer is connected)
- When power feed input voltage becomes less than 30 % of rated value

Alarm section 2 [PG23]



The setting of parameter group 23 (PG23) can be changed only in the control stop state.

#1: Factory set value

Symbol	Name	Setting range	Description	#1
PG23 (PG23)	Parameter group 23	—	The first characters of parameter group PG23.	—
AS1 (AS1)	Alarm 1 type selection	Refer to Table 1 (Alarm types)	Selects alarm 1 action.	0
EXC1 (EXC1)	Alarm 1 energize/de-energize selection	0: Energize alarm 1: De-energize alarm	Selects whether alarm 1 is set to energized alarm or de-energized alarm.	0
AEo1 (AEo1)	Alarm 1 action selection at abnormality	0: Normal action ¹ 1: Forced alarm output ON ¹	The alarm 1 action when an input error caused by sensor break, etc. occurs is selected.	0
AHo1 (AHo1)	Alarm 1 hold action selection ²	Refer to Table 2 (Hold action types)	Selects the presence or absence of alarm 1 hold action.	0

Table 1 (Alarm types)

Set value	Type
0	No alarm (Even if the instrument is set to "No alarm," the setting of "Energized/De-energized," or "Action at error occurrence" is effective.)
1	Set value high alarm
2	Set value low alarm
3	Process high alarm [Hold action can be added.]
4	Process low alarm [Hold action can be added.]
5	Deviation high alarm [Hold action can be added.]
6	Deviation low alarm [Hold action can be added.]
7	Deviation high/low alarm (Absolute value setting) [Hold action can be added.]
8	Band alarm (Absolute value setting) [Hold action can be added.]

Table 2 (Hold action types)

Set value	Type
0	No hold action
1	Hold action is taken when the power is turned on.
2	Hold action is taken when the power is turned on or the setting is changed.

¹ [0 : Normal action]: If an error occurs, the alarm action is taken as selected by alarm 1 or alarm 2 type selection.

[1: Forced alarm output ON]: If an error occurs, the alarm output is forcibly turned on regardless of the alarm action selected by alarm 1 or alarm 2 type selection.

² If there is no alarm 1, "-----" is displayed.

Continued on the next page.

Continued from the previous page.

Alarm section 2 [PG23]

#1: Factory set value

Symbol	Name	Setting range	Description	#1
AS2 (AS2)	Alarm 2 type selection	Refer to Table 1 (Alarm types)	Selects alarm 2 action.	0
EXC2 (EXC2)	Alarm 2 energize/de-energize selection	0: Energize alarm 1: De-energize alarm	Selects whether alarm 2 is set to energized alarm or de-energized alarm.	0
AEo2 (AEo2)	Alarm 2 action selection at abnormality	0: Normal action ¹ 1: Forced alarm output ON ¹	The alarm 2 action when an input error caused by sensor break, etc. occurs is selected.	0
AHo2 AHo2	Alarm 2 hold action selection ²	Refer to Table 2 (Hold action types)	Selects the presence or absence of alarm 2 hold action.	0

Table 1 (Alarm types)

Set value	Type
0	No alarm (Even if the instrument is set to "No alarm," the setting of "Energized/De-energized," or "Action at error occurrence" is effective.)
1	Set value high alarm
2	Set value low alarm
3	Process high alarm [Hold action can be added.]
4	Process low alarm [Hold action can be added.]
5	Deviation high alarm [Hold action can be added.]
6	Deviation low alarm [Hold action can be added.]
7	Deviation high/low alarm (Absolute value setting) [Hold action can be added.]
8	Band alarm (Absolute value setting) [Hold action can be added.]

Table 2 (Hold action types)

Set value	Type
0	No hold action
1	Hold action is taken when the power is turned on.
2	Hold action is taken when the power is turned on or the setting is changed.

¹ [0 : Normal action]: If an error occurs, the alarm action is taken as selected by alarm 1 or alarm 2 type selection.

[1: Forced alarm output ON]: If an error occurs, the alarm output is forcibly turned on regardless of the alarm action selected by alarm 1 or alarm 2 type selection.

² If there is no alarm 2, "-----" is displayed.

Communication section [PG24]



The setting of parameter group 24 (PG24) can be changed only in the control stop state.

#1: Factory set value

Symbol	Name	Setting range	Description	#1
<i>PG24</i> (PG24)	Parameter group 24	—	The first characters of parameter group PG24.	—
<i>Add</i> (Add)	Device address ¹	00 to 99	Sets device address of this instrument.	0
<i>bPS</i> (bPS)	Communication speed ²	0: 1200 bps 1: 2400 bps 2: 4800 bps 3: 9600 bps 4: 19200 bps	Selects communication speed.	3
<i>bit</i> (bit)	Communication data bit configuration ²	Refer to Table 1 (Communication data bit configuration)	Selects data bit configuration during communication.	0
<i>InT</i> (InT)	Interval time ²	0 to 250 ms	Sets interval time to match timing during data send and receive.	250
<i>CMPS</i> (CMPS)	Protocol selection ²	0: RKC standard communication 1: Ladder communication	Selects communication protocol.	0

¹ If the 2-channel type, set independent device addresses to CH1 and CH2.

² If the 2-channel type, set the same value to CH1 and CH2.

Table 1 (Communication data bit configuration)

Set value	Parity bit	Data bit	Stop bit
0	None	8	1
1	None	8	2
2	Even	8	1
3	Even	8	2
4	Odd	8	1
5	Odd	8	2
6	None	7	1
7	None	7	2
8	Even	7	1
9	Even	7	2
10	Odd	7	1
11	Odd	7	2

Set data lock section [PG40]

#1: Factory set value



Symbol	Name	Setting range	Description	#1
 (PG40)	Parameter group 40	—	The first characters of parameter group PG40.	—
 (LCK)	Set data lock level selection	Refer to Table 1 (Set data lock level)	Set level which enables set data lock.	0
 (MLCK)	Mode lock level selection	Refer to Table 2 (Mode lock level)	Set level which enables mode lock.	0

Table 1 (Set data lock level)

Set value	Set data lock level
0	Set value (SV) and parameter cannot be set.
1	Only set value (SV) can be set.
2	Only parameter group (PG) cannot be set.

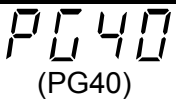
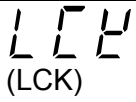

If order to make the set data lock effective, select "Lock" by using the set data lock function on the mode transfer.

Table 2 (Mode lock level)





Set value	PID/AT	AUTO/MANUAL	Control RUN/STOP
0	×	×	×
1	×	—	×
2	—	×	×
3	—	—	×
4	×	×	—
5	×	—	—
6	—	×	—
7	—	—	—

—: Unsettable (Mode lock)

×: Settable (Mode unlock)

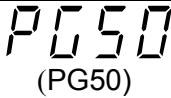
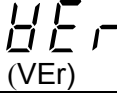

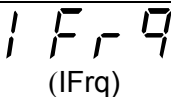
Data section [PG50] (Only display)

#1: Factory set value

Symbol	Name	Setting range	Description	#1
 (PG50)	Parameter group 50	—	The first characters of parameter group PG50.	—
 (VER)	ROM version	□□□□□	The SV display unit shows the ROM number.	—
 (UT)	Operating time	0 to 99999 time	Display the totalized operation time of this instrument.	—
 (IFrq)	Measured power supply frequency *	0.00 to 100.00 Hz	Displays the power supply frequency measured by the power feed input.	—
 (HEAT)	Measured heater voltage *	0.0 to 160.0 %	Heater voltage measured by using power feed input is displayed in % to the rated value.	—

* Displays "00000" if the power feed transformer is not connected.

(3) Procedure for setting each parameter

-  For this instrument, the numeric value is not registered if it is only change by the SET key.
-  If the set data is lock, all of the digits on the SV display unit are brightly lit and the set value cannot be changed.
-  The setting of PG20, PG21, PG22, PG23, or PG24 can be changed only when control stops.

[Example] When the setting limiter (high limit) is changed to 30.000 °C

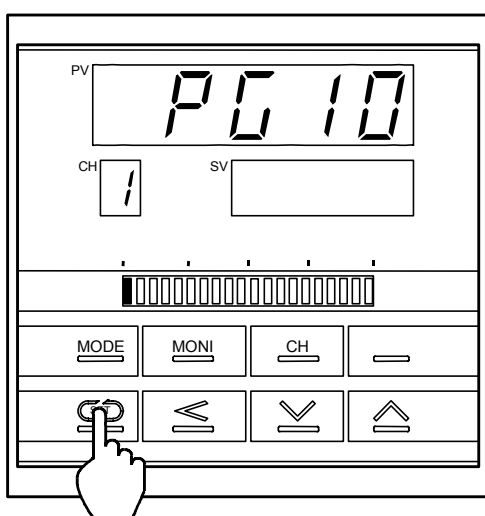

Parameter group 10 (PG10)

1. Press the SET key for more than 5 sec in operator set mode to set the instrument to setup mode. Setup mode is selected, "Parameter group 10 (PG10)" is displayed first.

 For the details of setup mode selection, refer to "5.1 Calling-Up Procedure of Monitor and Each Mode."

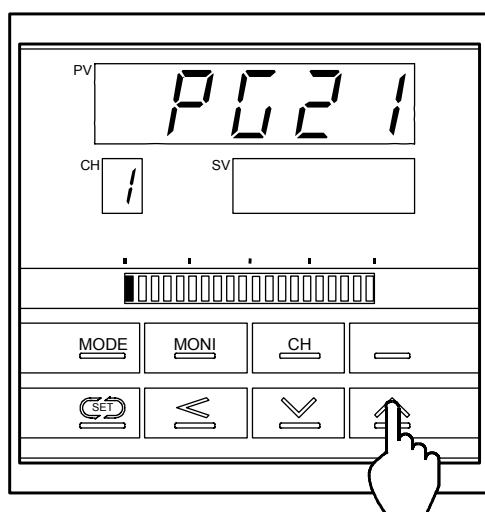

Parameter group 21 (PG21)

2. Press the UP key to set the instrument to the PG21 (Setting limiter section).

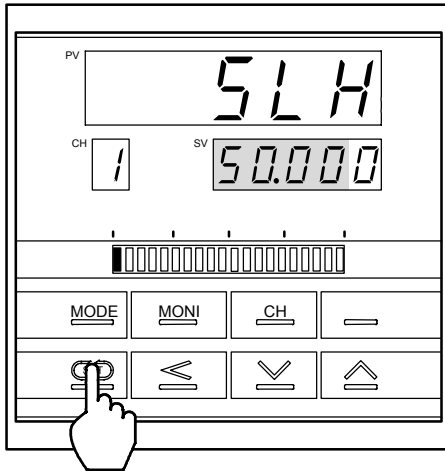

Setting limiter (high limit)

3. Press the SET key to set the instrument to the "Setting limiter (high limit)."

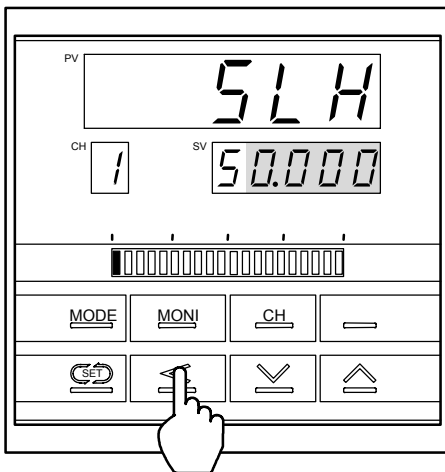

4. Press the SHIFT key to move the brightly lit digit up to the most significant digit. Every time the SHIFT key is pressed, each brightly lit digit moves as follows.

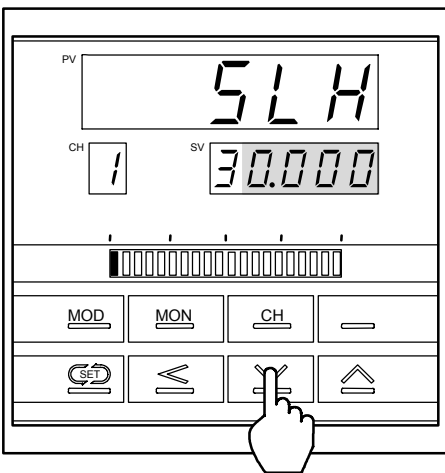
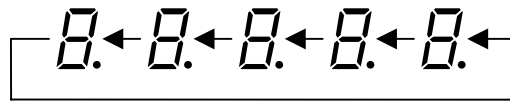



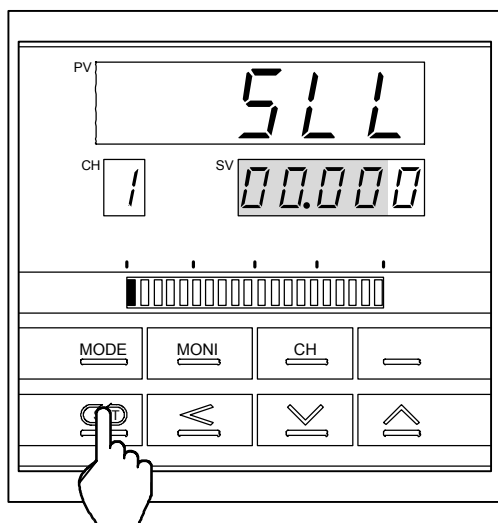

5. Press the DOWN key to enter "3" in the most significant digit.



6. Press the SET key to change to the next parameter. Thus, the set value is registered.

Setting limiter (low limit)

-  The same setting procedure applies when other parameters are also set.
-  For the instrument of 2-channel type, press the CH key to select CH2, then make the setting. The setting procedure is the same as the CH1 parameter setting.
-  For the 1-channel type, if the key is not operated for within 1 minute, the present display automatically returns to the PV/SV display.
-  For the 2-channel type, if the key is not operated for within 1 minute, the present display automatically returns to the CH1PV/CH2PV display.

5.7 Procedure for Selecting CH2 (For 2-channel type)

In order to set the CH2 monitor, set value (SV) or each parameter, press the CH key to change CH1 to CH2. The setting procedure is the same as the CH1 setting.

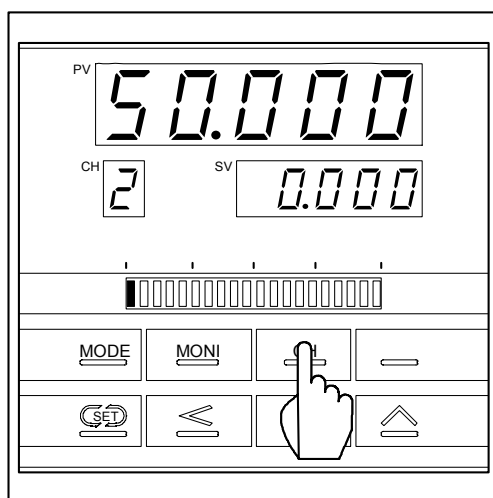

PV/SV display (CH2)

6. OPERATIONS

CAUTION

- Connect the input signal wiring, and then turn ON the power. Otherwise, this controller judges that the input line breaks to be set to the FAIL state.
Action at input break: Up-scale Action at input short circuit: Downscale
- Even when only one channel is used for the 2-channel input type of controller, connect sensors to both channels. Otherwise, this controller judges that the input line breaks to be set to the FAIL state.
- When no contact input (DI) is used, always short the contact input (DI) terminals (Nos. 6 and 7). Otherwise, no control can be started by the front key or via communication.
- If the following value is set with no power feed input used, control cannot be performed as it stops.
Power supply frequency → Auto setting Power feed forward function → ON
- No influence is exerted upon the instrument for power failure of 20 ms or less.
For power failure of 20 ms more than, the instrument performs the same operation as that at the time of power-ON after power recovery.

(1) Procedure for operation

1. Before turning on the power, check that all of the mounting and wiring are correctly made.
2. Turn on the power of this instrument.

If the power is turned on for the first time, as the instrument is set to the control RUN state, set the instrument to the control STOP state by "Control RUN/STOP transfer" (refer to P. 20).

 For details on "Control RUN/STOP," refer to "**(3) Control RUN/STOP transfer by contact input**" (P. 23).

3. Check that the set value (SV) and each parameter are correctly set.
4. Control starts if control STOP is changed to control RUN.



If the RUN/STOP of 2-channel type

- The RUN/STOP can be selected for every channel when the RUN/STOP is selected by front key.
- The RUN/STOP cannot be selected for every channel when the RUN/STOP is selected by contact input (DI). Both CH1 and CH2 are simultaneously selected.

(2) Operation under operation execution (RUN)

- For needing a change in the details of display in the monitoring status, refer to "**5.2 Monitor**" (P. 18).
- When needing a change in the set value (SV), refer to "**5.4 SV Setting Mode**" (P. 24).
- When needing a change in the alarm set value and PID, refer to "**5.5 Operator Set Mode**" (P. 26).
- For needing a change in the each parameter, refer to "**5.6 Setup Mode**" (P. 30).
However, as parameters which cannot be changed during control RUN are included in parameters in setup mode, set the instrument to the control STOP state once to change the parameter.
- When needing activation of the autotuning (AT) function, refer to "**(4) Requirements for autotuning (AT)**" (P. 47).

(3) Cautions at operation stop (STOP)

In the monitoring status, the measured value (PV) display unit shows measured value (PV).
Also the set value (SV) display unit, " Σ Γ \square ρ (SToP)".

(4) Requirements for autotuning (AT)

Autotuning (AT) is the function of automatically measuring, computing and setting the optimum PID constants. The requirements for autotuning (AT) start and suspension are described in the following. Autotuning (AT) is started/stopped by "PID/AT transfer" in the mode transfer (refer to P. 20).

■ Requirements for autotuning (AT) start

Start autotuning (AT) when all the following conditions are satisfied:

1. In the mode transfer
 - PID/AT transfer → PID
 - Control RUN/STOP transfer → RUN
 - AUTO/MANUAL transfer → AUTO mode
2. Input value should not be abnormal.
3. The output limiter (high) value should be 0.1 % or more and the output limiter (low) value, 99.9 % or less.



Execute the auto-tuning for every channel when the F9000 is 2-channel type.

■ Requirements for autotuning (AT) suspension



- When set value (SV) is changed
- When output limiter (high) or output limiter (low) value is changed
- When PV bias and/or digital filter are changed
- When AT bias is changed
- When the instrument is transferred to the manual mode by "AUTO/MANUAL transfer"
- When control is stopped by "Control RUN/STOP transfer"
- When the instrument is transferred to PID control by "PID/AT transfer"
- When input value becomes abnormal.
- When power failure occurs
- When the instrument is in the FAIL status



When autotuning (AT) suspension requirements are established, the instrument immediately suspends autotuning (AT) function to transfer the above function to PID control. PID constants at that time are left as they were before autotuning (AT) start.

7. DISPLAY AT ABNORMALITY

■ For input abnormality

Display	Description	Action (output)	Solution
Measured value (PV) Flashing	Input abnormality Measured value (PV) exceeds the setting limiter (high limit) or setting limiter (low limit).	The controller takes alarm action which is selecting of parameter group 23 (PG23).	 WARNING To prevent electric shock, always turn off the power before replacing the sensor.
 Flashing	Over-scale Measured value (PV) is beyond the effective input range.		
 Flashing	Underscale Measured value (PV) is below the effective input range.		

Each status at input abnormality is shown in the following:

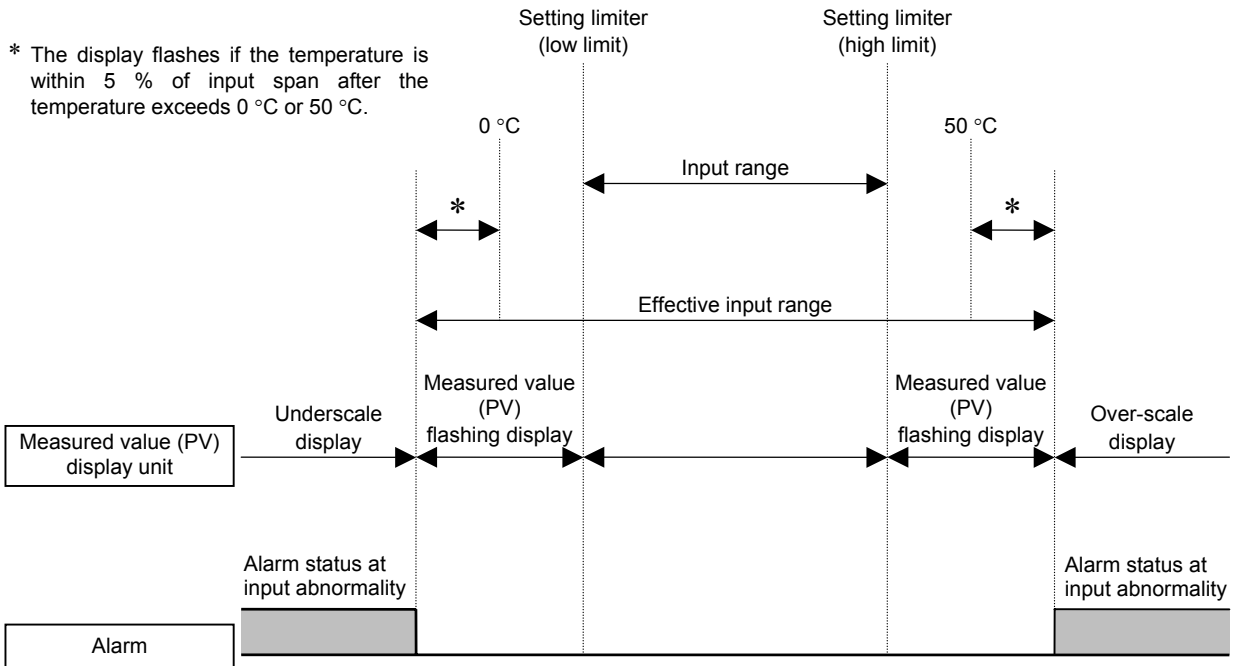

The setting limiter (high limit or low limit) is set by parameter setting group 21 [PG21] (refer to P. 36) in setup mode.

■ By self-diagnostic function

In an error is detected by the self-diagnostic function, the PV display unit flashes "Err," and the SV display unit shows the error code. Error is displayed on the "PV/SV" display. In addition, the FAIL lamp light if an error occurs.

If two or more errors occurs simultaneously, the total summation of these error codes is displayed.

Error code	Details	FAIL	Control output	Alarm output	Analog output	Measures		
—	MCU abnormality	OPEN Note 1	OFF	OFF	OFF	Turn off the power once. If an error occurs after the power is turned on again, please contact RKC sales office or the agent.		
—	MCU power supply voltage abnormality							
—	Software abnormality							
16	Input circuit abnormality						Note 2	No affected
8	EEPROM error						No affected	
4	Adjusted data destruction						Note 2	
2	Sensor break						No affected	
1	Other abnormality *						No affected	

Note 1: FAIL output: The relay contact is closed under normal operation.

Note 2: The REX-F9000 takes any alarm action selected in the parameter group "23" (PG23).

* Any one of other errors (Error 1) is an error item which informs the operator that an error occurs in a different channel.

Example: When EEPROM error and adjusted data destruction occurs simultaneously

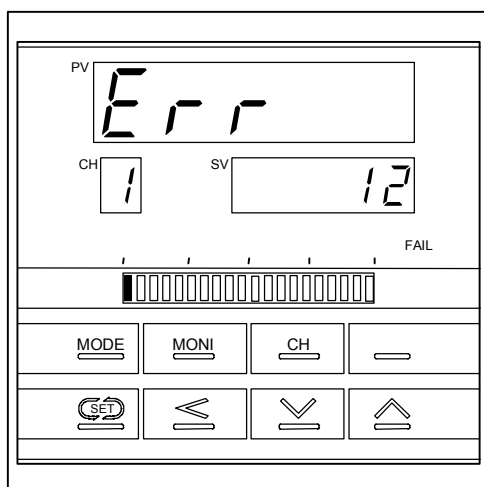

The PV display unit shows "Err," and the SV display unit shows the number **12** obtained by adding **8** (EEPROM error) to **4** (adjusted data destruction).



Even when an error occurs in either CH1 or CH2, the error number is displayed in both channels.

8. REPLACING THE RUBBER PACKING



WARNING

- In order to prevent electric shock and instrument failure, always turn off the power supply before replacing the rubber packing.
- In order to prevent electric shock and instrument failure, always turn off the power supply before pulling out the internal chassis.
- In order to prevent injury or instrument failure, do not touch the internal printed circuit board.

If the waterproof and dustproof rubber packing deteriorates, please contact RKC sales office or the agent.

Parts code	Remarks
KF900N-32	For the board
KD900-35	For the case

■ Replacement of rubber packing

To replace the rubber packing, take the following steps:

CAUTION

Prior to replacing the rubber packing, first confirm that no water remains, then turn on the power supply. If the water remains, shorting may result.

(1) For the board

1. Pull the internal assembly out of the case, then remove the old rubber packing.

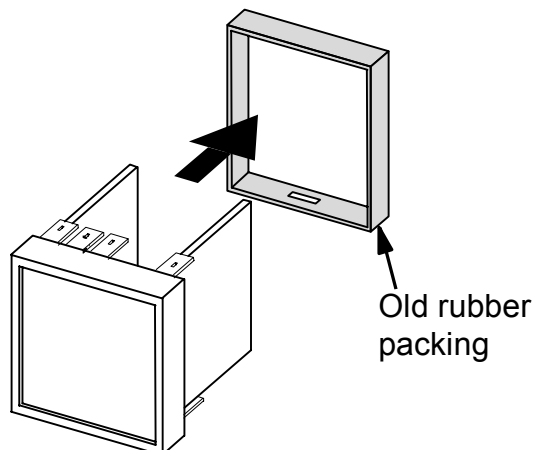

2. Replace the old rubber packing with a new one, then put the internal chassis in the case.

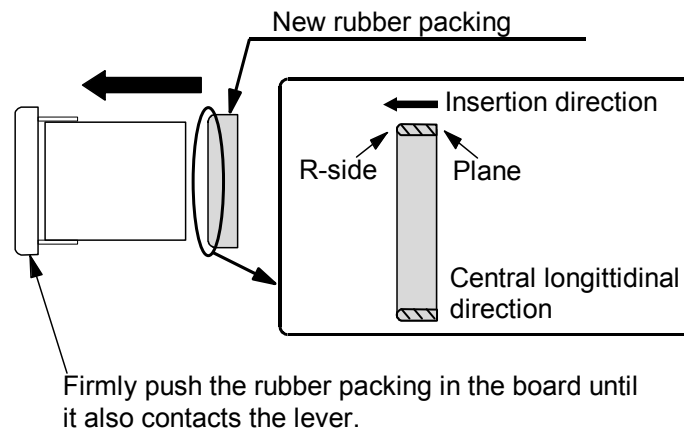

(2) For the case

1. Remove the mounting bracket and disconnect all of the lead wires from the rear terminal board of this instrument, then remove the instrument from the control panel. Next, remove the deteriorated rubber packing from this instrument.

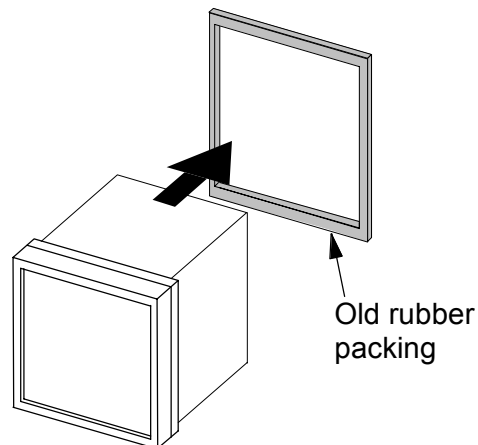

2. Firmly push the new rubber packing into the instrument, then re-mount the instrument in the control panel.

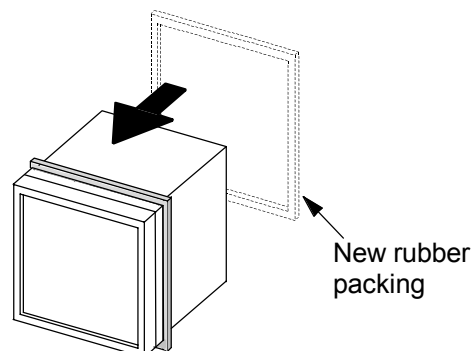

9. FUNCTION DESCRIPTION

9.1 PV Bias

The value set in the PV bias is added to the actual input value to correct the input value. The PV bias is used to correct the individual variations in the sensors or when there is difference between the measured value (PV) of other instruments.

9.2 Digital Filter

This is a 1st-order lag filter by software prepared in order to reduce fluctuations of measured value (PV) by noise. Thus, control eliminating input noise influence becomes possible by setting appropriately this filter time constant according to measured object characteristics and noise level. However, if the time constant is too small, the filter may yield no benefit, but and if the time constant is too large, control response will be adversely affected.

9.3 Control Response Parameter

The control response parameter function is used to determine how to respond to temperature set value (SV) changes in PID control. One control response parameter can be selected from among three steps (Slow, Medium, Fast). In order to achieve faster controlled object response to set value (SV) change, select Fast. However, slight overshoot is unavoidable when selecting Fast. Depending on the controlled object, specify Slow if overshoot should be avoided.

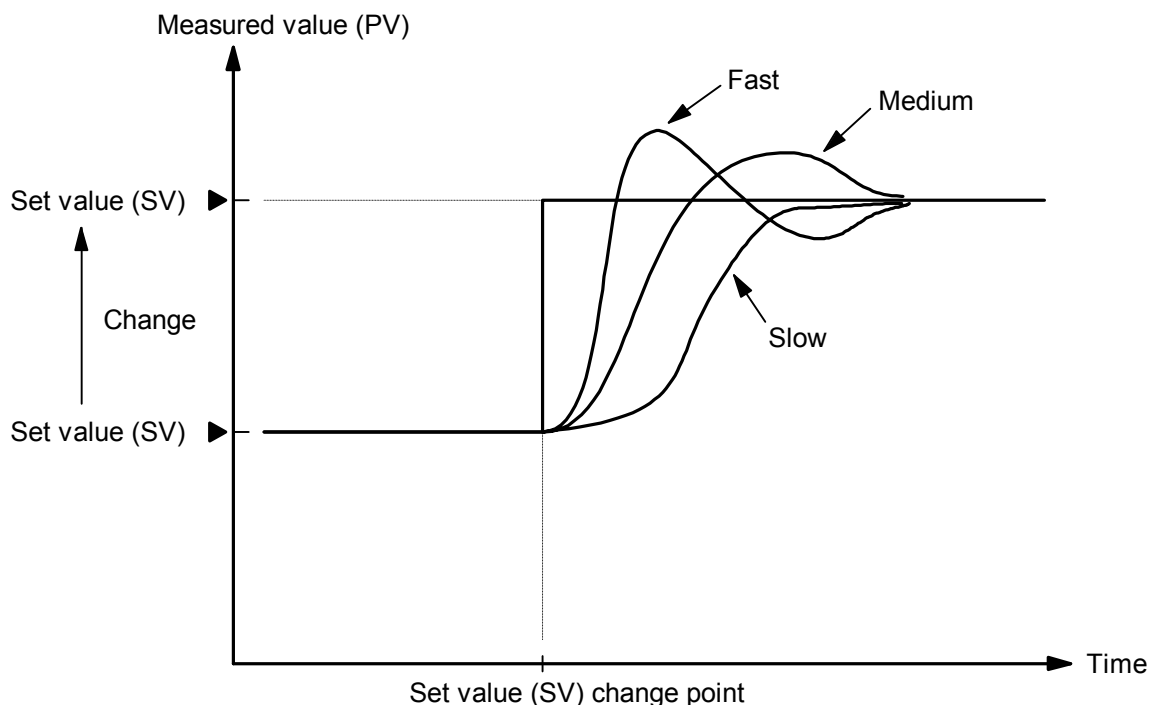

9.4 AT Bias

The AT bias is set when the autotuning (AT) function in which the measured value (PV) does not exceed the set value (SV) is activated. Our autotuning method performs ON/OFF control centering around the set value (SV), then calculates and sets each of the PID constants by hunting the measured value (PV). However, overshooting caused by this hunting may not be preferable depending on the controlled object. In such a case, the desired AT bias is set. If it is set, another set value (SV) to activate the autotuning function [AT point] can be set.

Example: When AT bias is set to the minus (–) side

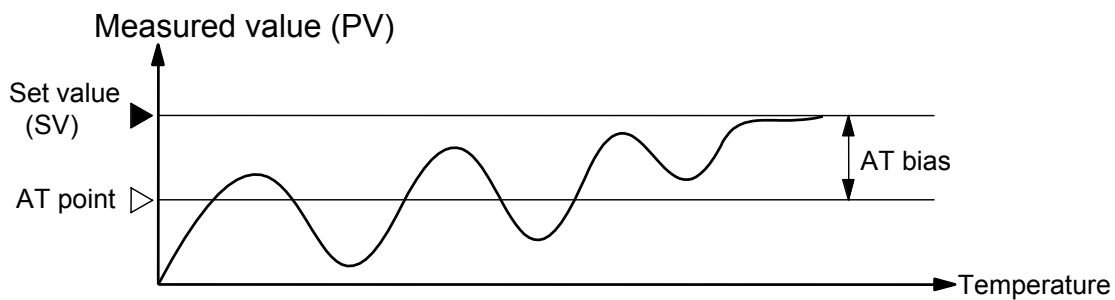

9.5 Sensor Bias Function

The sensor bias function is used to correct the input value by using sensor calibration data provided from the sensor manufacture.

This correction is made so that sensor calibration data is subtracted from the sensor true value and the result thus obtained is input to this instrument.

Example: For RTD of Pt 100 Ω , 23 $^{\circ}\text{C}$

Sensor calibration data: 23 $^{\circ}\text{C}$ = 108.9721 Ω

Sensor true value at 23 $^{\circ}\text{C}$: 108.9585 Ω

108.9585 (Sensor true value) – 108.9721 (Calibration data) = –0.0136 Ω

From the above,

Input correction value: –0.0136 Ω

9.6 Alarms (ALM)

Alarm (ALM) function sets up the alarm status when the measured value (PV) or the deviation reaches the alarm set values. In the alarm status, the alarm output is output from the digital output terminals, and the alarms are used to drive the equipment danger signals or the safety equipment.

(1) Deviation alarm

The alarm lamp lights if the deviation [Measured value (PV) – Set value (SV)] reaches the alarm set value. Therefore, the alarm set value moves with set value (SV) change.

● Deviation high alarm

The alarm lamp lights if the deviation [Measured value (PV) – Set value (SV)] exceeds the alarm set value to produce the alarm status.

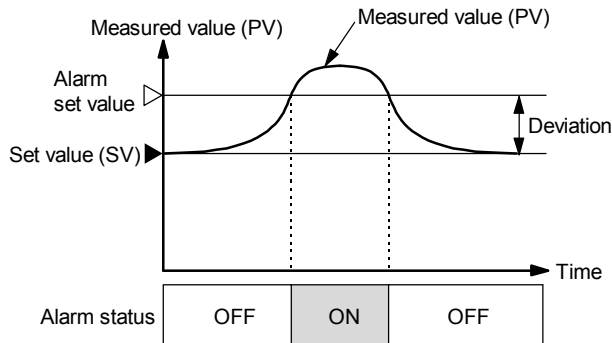

[When the deviation is on the positive side]

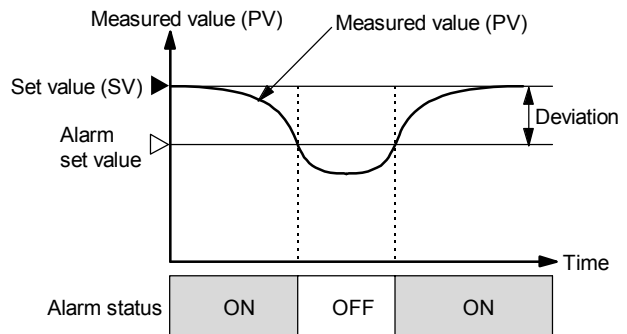

[When the deviation is on the negative side]

● Deviation low alarm

The alarm lamp lights if the deviation [Measured value (PV) – Set value (SV)] falls below the alarm set value to produce the alarm status.

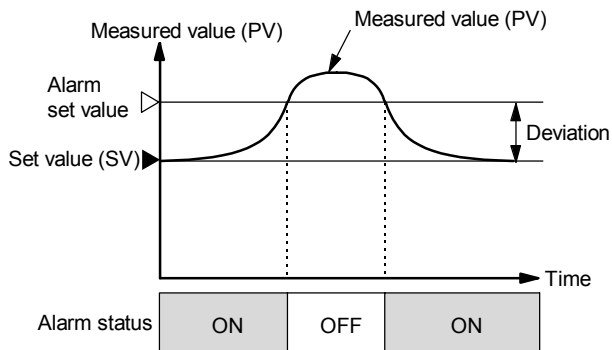

[When the deviation is on the positive side]

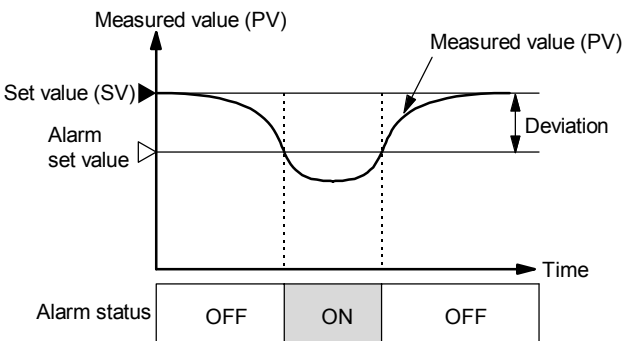

[When the deviation is on the negative side]

● Deviation high/low alarm

The alarm lamp lights if the deviation absolute value $|\text{Measured value (PV)} - \text{Set value (SV)}|$ is less than or greater than the alarm set value to produce the alarm status.

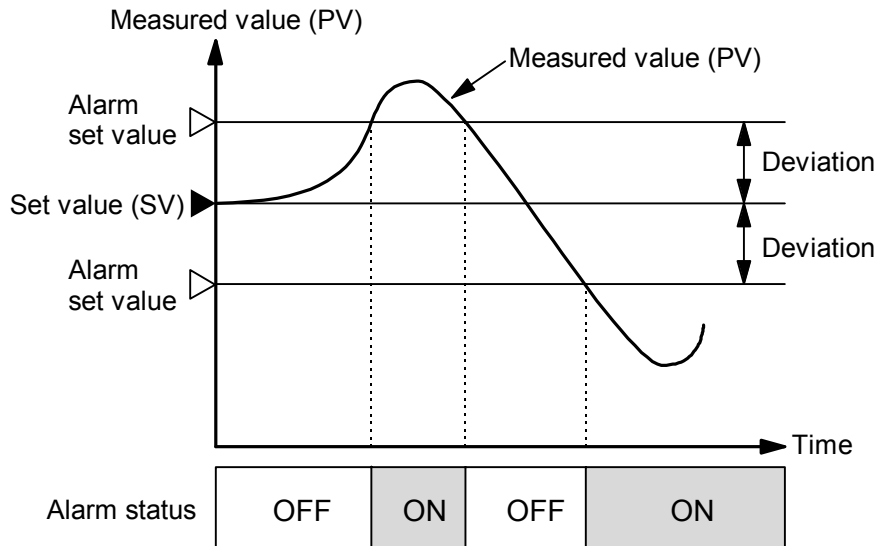

● Band alarm

The alarm lamp lights if the deviation absolute value $|\text{Measured value (PV)} - \text{Set value (SV)}|$ is within the alarm set value to produce the alarm status.

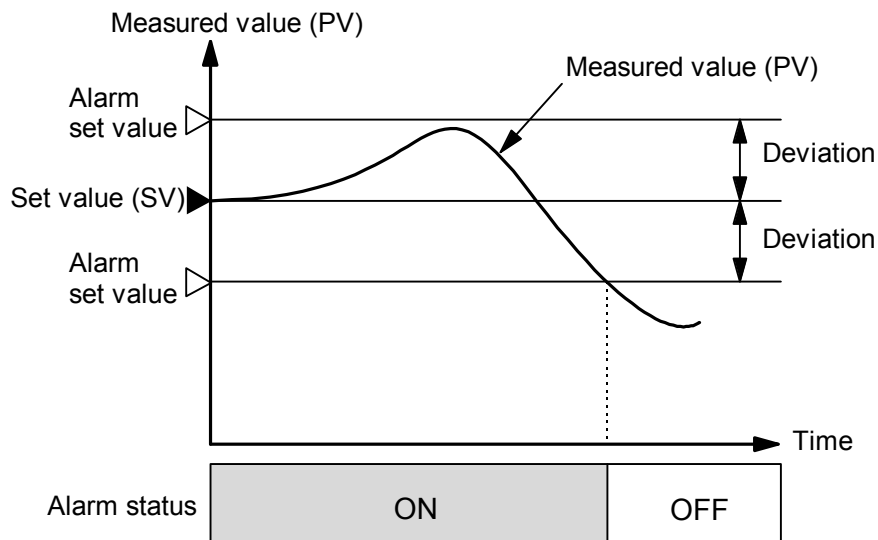

(2) Process alarm

This alarm function if measured value (PV) reaches the alarm set value.

● Process high alarm

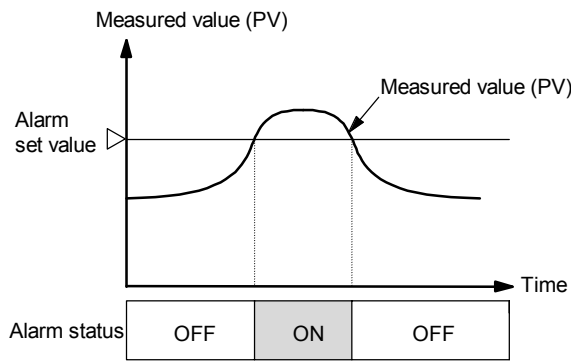

● Process low alarm

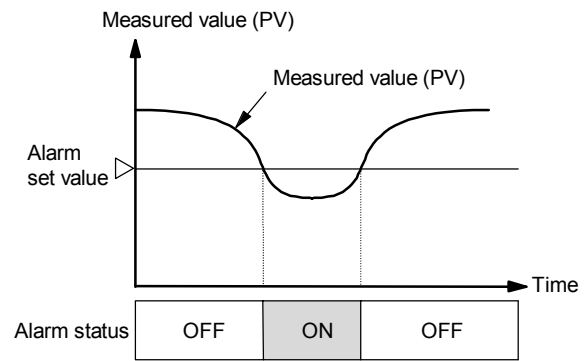

(3) Alarm differential gap

Alarm relay contact may repeat its turning ON and OFF due to input fluctuation if measured value (PV) is near the alarm set value. An alarm differential gap setting can prevent the relay contact from ON or OFF repetition.

● High alarm (deviation/process)

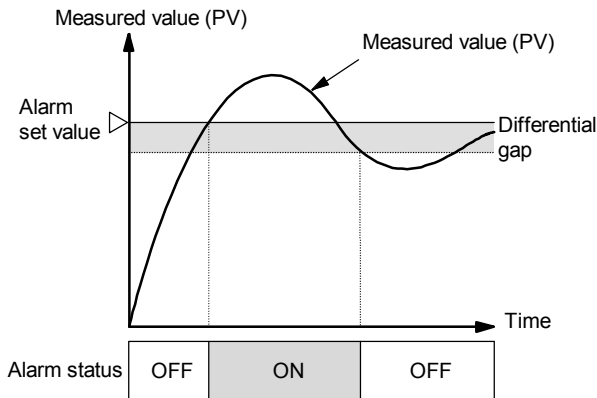

● Low alarm (deviation/process)

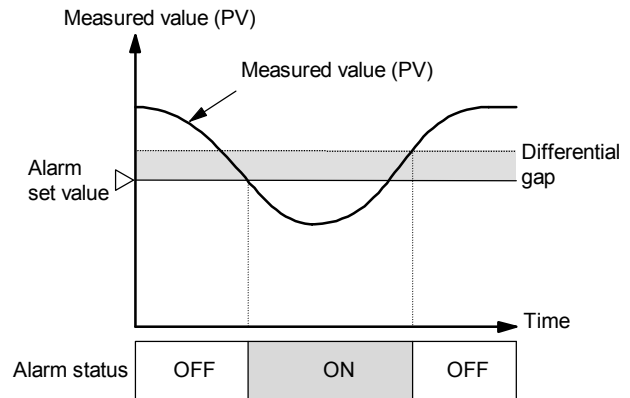

● **High/Low alarm (deviation/process)**

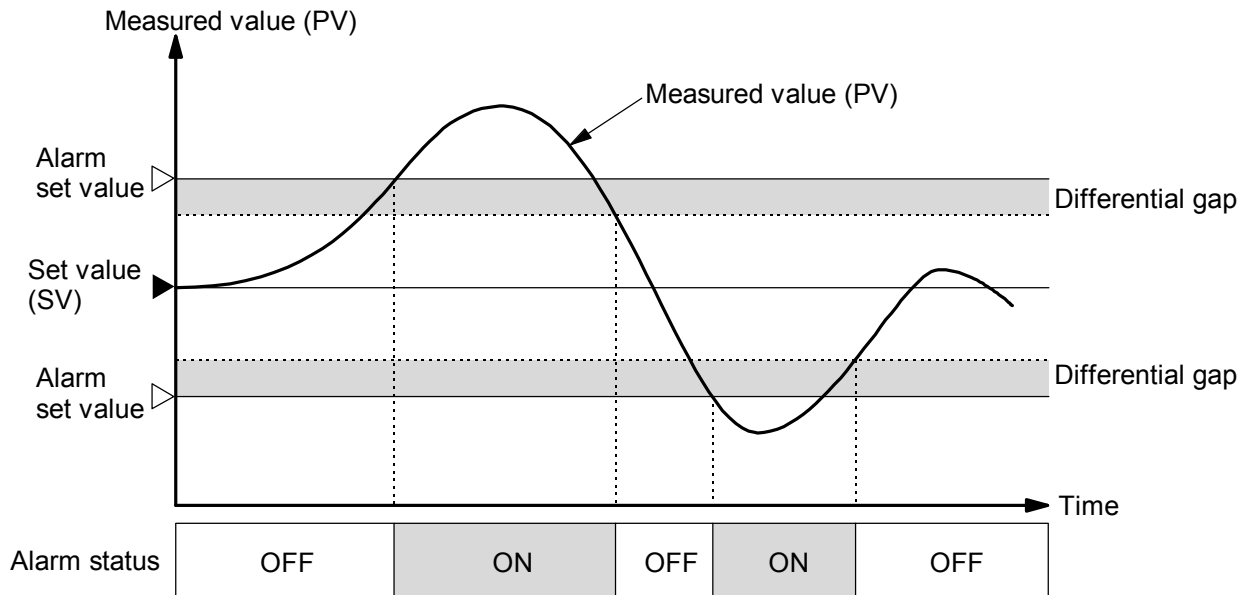

● **Band alarm**

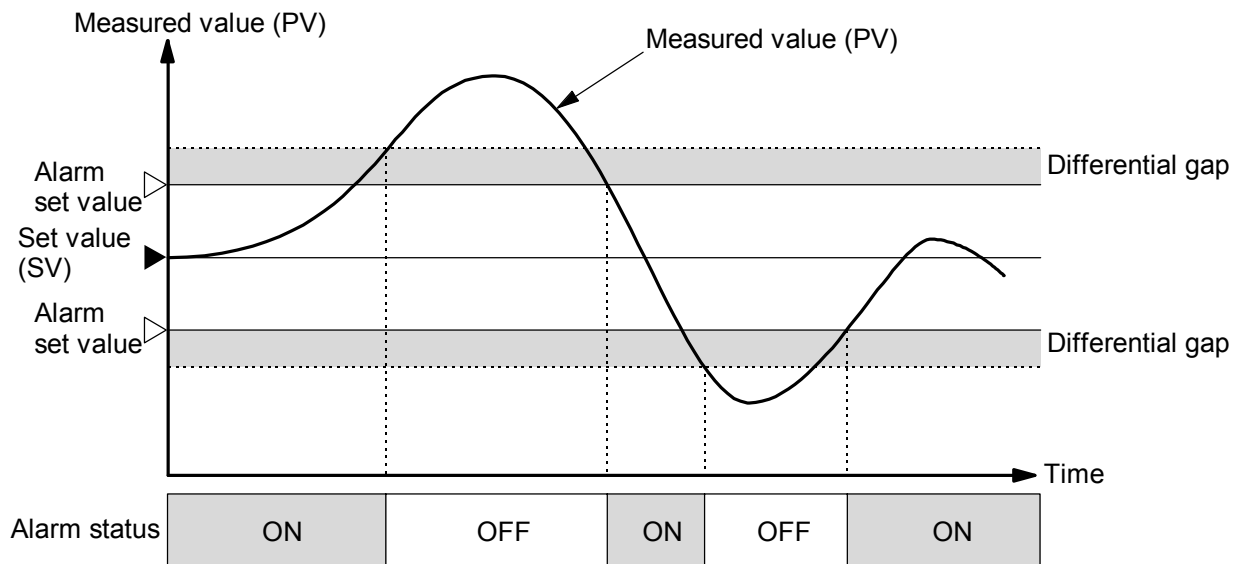

(4) Alarm hold action

Hold action is an action which makes the alarm function invalid even if measured value (PV) is in the alarm status at the time of power-ON, transferring operation mode from STOP to execution (RUN) or changing the set value (SV). This state continues until the above measured value (PV) once exits from the alarm status.

Example: The difference between alarms with "Hold action" and without "Hold action" are described by referring to the low limit deviation alarm as an example.

● **With alarm hold action**

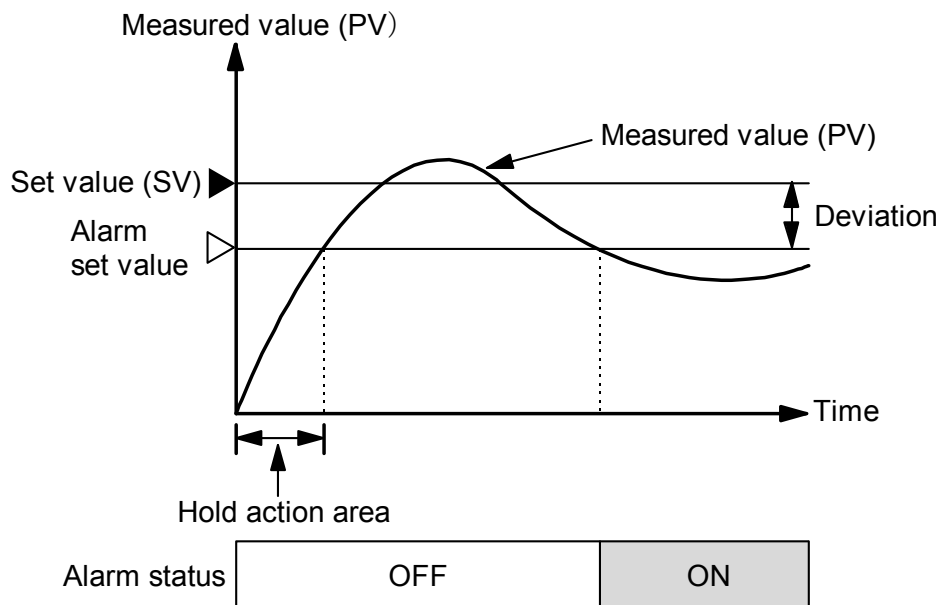

● **Without alarm hold action**

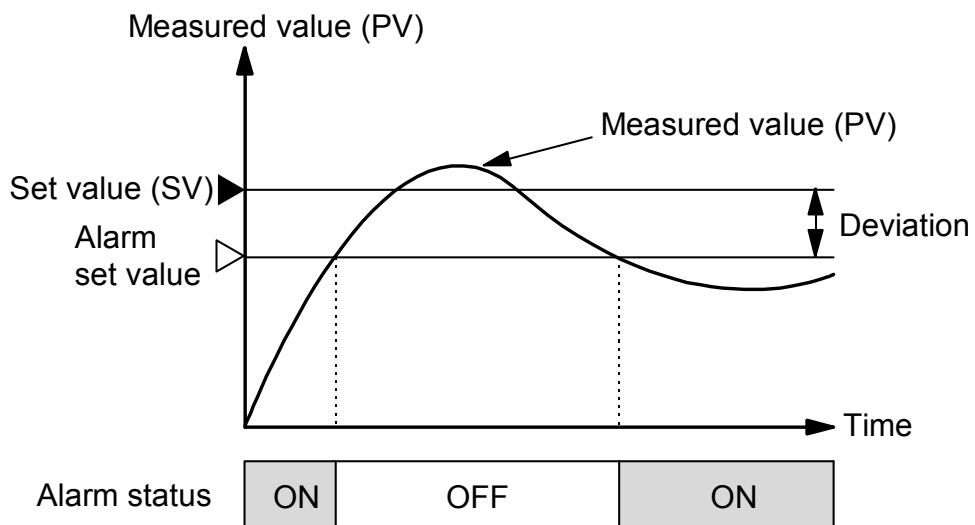

(5) Alarm timer

This is the function of setting the timer to the non-alarm status as far as it is within the alarm timer set time and to the alarm status if it exceeds the alarm timer set time after measured value (PV) or the deviation exceeds the alarm set value.

Example: When alarm timer is set to 100 sec.

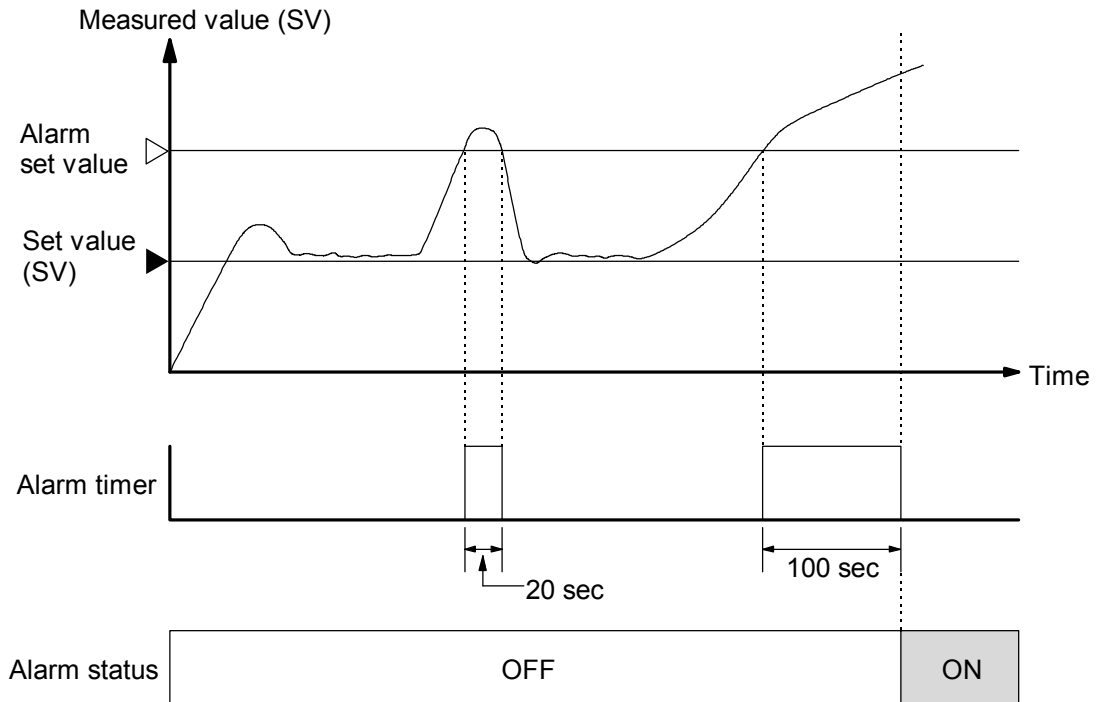

(6) Alarm energized/de-energized

Energized: Relay contact is closed under the alarm status.

De-energized: Relay contact opens under the alarm status.

Diagram for explaining operation (At power-ON)

	Non-alarm status	Alarm status
Energized		
De-energized		

9.7 Bar-Graph Display

This is a function of displaying manipulated output value (MV), or deviation on 20-dot LEDs.

(1) Manipulated output value (MV) display

Manipulated output value (MV) is displayed in a span of from 0 to 100 %. One dot is 5 % fixed.

Example: For 40 % manipulated output value (MV)

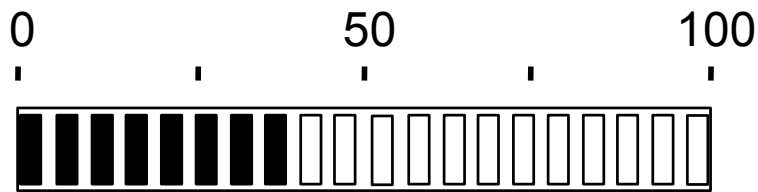

When manipulated output value (MV) becomes 0 % or less, the dot at the left end of the bar-graph only flashes and when it exceeds 100 %, all dots on the bar-graph light and only the dot at the right end flashes.

(2) Deviation display

The deviation between measured value (PV) and set value (SV) displayed. The dots at both ends of bar-graph light to indicate deviation display. One dot is variable in a range of from 1 to 100 digit. Either 0.01 °C or 0.1 °C corresponding one dot can be selected.

Example: For a range of -0.1 °C to +0.1 °C and a deviation of -0.05 °C

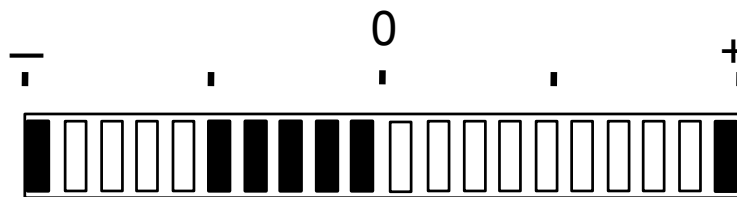

9.8 Power Feed Forward Function

The power feed forward function is used to stabilize the control point by monitoring the load voltage by the power feed transformer. If the power feed input voltage becomes less than approx. -30 % of the rated value, control automatically stops.

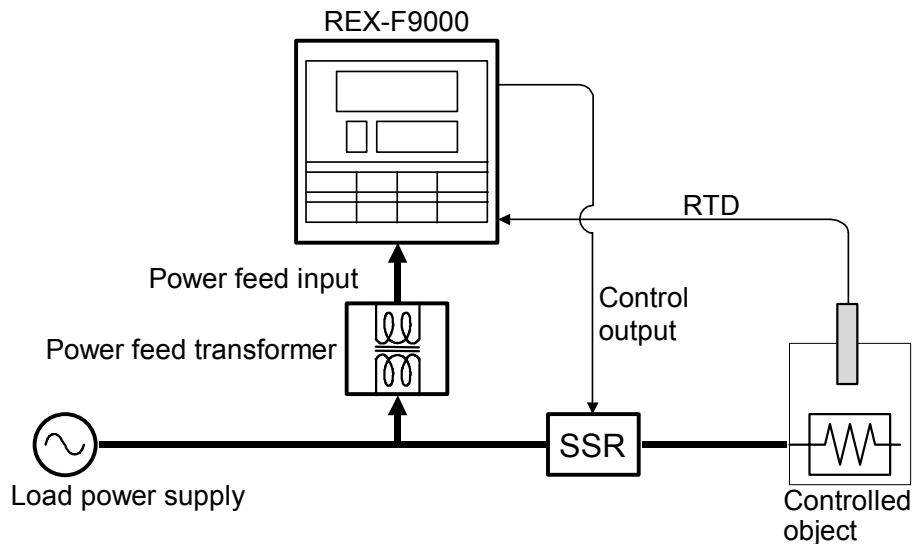

9.9 Power Supply Frequency Setting

The power frequency is set to reject normal mode noise contained in the input. If the power frequency of this instrument is set to "Automatic setting (refer to P. 36)," it is automatically measured and set by the power feed input. If the power feed input voltage becomes less than approx. -30 % of the rated value, control automatically stops.



If the power feed input is not used, auto setting cannot be used.

9.10 Setting Limiter

This is the function of limiting the set value (SV) setting range.

[Example] When the setting range is between 0.000 and 50.000 °C and the high and low setting limits are set to 40.000 °C and 10.000 °C, respectively.

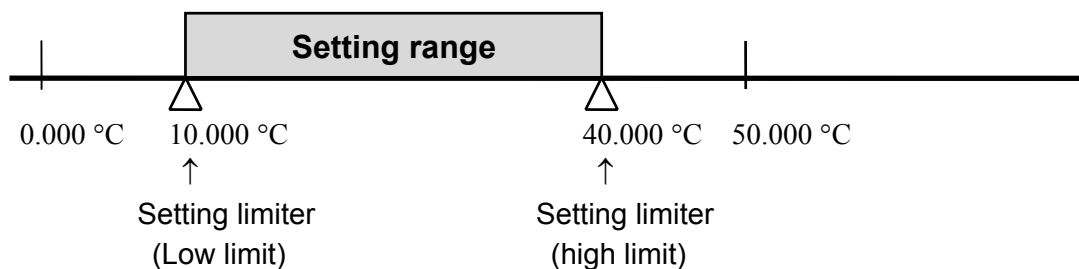

10. SPECIFICATIONS

■ Input

Input type:	RTD input Pt100 Ω (JIS/IEC), JPt100 Ω (JIS) Corresponding to the 3- and 4-wire systems
Number of input points:	1 point or 2 points
Input range:	0.000 to 50.000 $^{\circ}\text{C}$
Action at input break:	Up-scale
Action at input short circuit:	Downscale

■ Display Function

Measured value (PV) display unit:	5 digit, 7-segment LED (Green)
Set value (SV) display unit:	5 digit, 7-segment LED (Orange)
Channel (CH) display unit:	1 digit, 7-segment LED (Orange)
Bar-graph display unit:	20 dot LED (Green)

■ Control Action

Control method:	Brilliant PID control (With autotuning function)
Output limiter:	Both of the output limiters (high limit and low limit) can be set.
Control output:	Voltage pulse output: Output voltage: 0/12 V DC Allowable load resistance: 600 Ω or more Output cycle time: 0.1 to 100.0 sec Current output: Output current: 4 to 20 mA DC Resolution: 13 bits or more Allowable load resistance: 600 Ω or less

■ Performance

Setting accuracy:	Temperature setting: ± 0.05 $^{\circ}\text{C}$ Other setting: Within ± 0.1 % of setting range
Input display accuracy:	± 0.05 $^{\circ}\text{C}$
Insulation resistance:	Between measuring and grounding terminals: 20 M Ω or more at 500 V DC Between power and grounding terminals: 20 M Ω or more at 500 V DC
Withstand voltage:	Between measuring and grounding terminals: 1 minute at 1000 V AC Between power and grounding terminals: 1 minute at 1500 V AC Between power and measuring terminals: 1 minute at 2300 V AC
Power failure effect:	No influence is exerted upon the instrument for power failure of less than 20 ms.
Memory backup:	Backed up by non-volatile RAM Number of write times: Approx. 100,000 times Data storage period: Approx. 10 years

■ Alarm Function

Number of alarm point: 2 points, each

Alarm type: Deviation high alarm *
Deviation low alarm *
Deviation high/low alarm *
Band alarm *
Process high alarm *
Process low alarm *
Set value high alarm
Set value low alarm
* Hold action can be added.

Differential gap: 0.000 to 5.000 °C

Alarm timer: 0 to 600 sec

Output method: Energized output or De-energized output

Output type: Relay contact output 250 V AC, 1 A (Resistive load) 1a contact
Electrical life: 50,000 times or more

■ Contact Input Function

Number of input point: 1 point

Function: Control RUN/STOP transfer

Input type: Dry contact input
At open: 500 k Ω or more
At close: 10 Ω or less

■ Communications

Interface:	Based on EIA standard RS-485
Connection method:	2-wire system, half-duplex multidrop connection
Communication distance:	1 km *However, the maximum communication distance varies slightly with the surroundings such as cable etc.
Synchronous method:	Start/stop synchronous type
Communication speed:	1200 bps, 2400 bps, 4800 bps, 9600 bps or 19200 bps
Communication data configuration:	RKC standard communication: Start bit: 1 Data bit: 7 or 8 Parity bit: Unused or Used (Odd number or even number) Stop bit: 1 or 2 Ladder communication: Start bit: 1 Data bit: 8 (Fixed) Parity bit: None Stop bit: 1
Protocol:	RKC standard communication: ANSI X3.28-1976 subcategories 2.5 and A4 (Polling/selecting type) Ladder communication: Non-protocol type
Error control:	RKC standard communication: Vertical parity check (With parity bit selected) Horizontal parity check (BCC check)
Maximum connection:	RKC standard communication: 32 sets including a host computer. Ladder communication: 32 sets including a PLC
Communication code:	RKC standard communication: ASCII 7-bit code Ladder communication : BCD code and Control code [STX, CR and LF]
Terminal resister:	100 Ω or more (Externally connected)
Xon/Xoff control:	None

■ Self-Diagnostic Function

Check item:	MCU, MCU power supply voltage, Input circuit, Adjustment data, Software (watchdog timer), EEPROM, and Sensor break check, etc.
Display at abnormality:	Failure lamp lights
FAIL output:	If an error occurs, the relay contact is opened. Relay contact output 250 V AC, 1 A (Resistive load), 1a contact Electrical life: 50, 000 times or more (Rated load)

■ Analog Output Function (Optional)

Number of output point:	1 point (1-channel type) 2 points (2-channel type)
Output signal:	Voltage output: 0 to 5 V DC, 1 to 5 V DC Current output: 0 to 20 mA DC, 4 to 20 mA DC Specify when ordering
Allowable load resistance:	Voltage output: 1 k Ω or more Current output: 600 Ω or less
Output scaling:	High and low limit can be set.
Output type:	Measured value (PV), Deviation (DEV), Set value (SV), Manipulated output (MV)

■ General Specifications

Power supply voltage:	85 to 264 V AC (50/60 Hz) [Including power supply voltage variation] (Rating: 100 to 240 V AC) 21.6 to 26.4 V AC (50/60 Hz) [Including power supply voltage variation] (Rating: 24 V AC) 21.6 to 26.4 V DC [Including power supply voltage variation] (Rating: 24 V DC)
Power consumption:	13 VA max. (at 100 V AC) 19 VA max. (at 240 V AC) 11 VA max. (at 24 V AC) 8.16 W [340 mA] max. (at 24 V DC)
Ambient temperature:	0 to 50 °C
Ambient humidity:	45 to 85 % RH (No condensation)
Operating environment:	There should be neither corrosive gas nor much dust.
Method of attachment:	Panel attachment
Weight:	Approx. 530 g
Dimensions:	96 (W) × 96 (H) × 100 (D) mm

MEMO



RKC INSTRUMENT INC.

HEADQUARTERS: 16-6, KUGAHARA 5-CHOME, OHTA-KU TOKYO 146-8515 JAPAN

PHONE: 03-3751-9799 (+81 3 3751 9799)

FAX: 03-3751-8585 (+81 3 3751 8585)

E-mail: info@rkcinst.co.jp

Website: <http://www.rkcinst.com/>