Digital Controller

***HA400/HA900
HA401/HA901***

***PROFIBUS
Communication
Instruction Manual***

- Company names and product names used in this manual are the trademarks or registered trademarks of the respective companies.

Thank you for purchasing this RKC product. In order to achieve maximum performance and ensure proper operation of your new instrument, carefully read all the instructions in this manual. Please place the manual in a convenient location for easy reference.

SYMBOLS

WARNING : This mark indicates precautions that must be taken if there is danger of electric shock, fire, etc., which could result in loss of life or injury.

CAUTION : This mark indicates that if these precautions and operating procedures are not taken, damage to the instrument may result.



: This mark indicates that all precautions should be taken for safe usage.



: This mark indicates important information on installation, handling and operating procedures.



: This mark indicates supplemental information on installation, handling and operating procedures.



: This mark indicates where additional information may be located.



WARNING

- An external protection device must be installed if failure of this instrument could result in damage to the instrument, equipment or injury to personnel.
- All wiring must be completed before power is turned on to prevent electric shock, fire or damage to instrument and equipment.
- This instrument must be used in accordance with the specifications to prevent fire or damage to instrument and equipment.
- This instrument is not intended for use in locations subject to flammable or explosive gases.
- Do not touch high-voltage connections such as power supply terminals, etc. to avoid electric shock.
- RKC is not responsible if this instrument is repaired, modified or disassembled by other than factory-approved personnel. Malfunction can occur and warranty is void under these conditions.

CAUTION

- This product is intended for use with industrial machines, test and measuring equipment. (It is not designed for use with medical equipment and nuclear energy.)
- This is a Class A instrument. In a domestic environment, this instrument may cause radio interference, in which case the user may be required to take additional measures.
- This instrument is protected from electric shock by reinforced insulation. Provide reinforced insulation between the wire for the input signal and the wires for instrument power supply, source of power and loads.
- Be sure to provide an appropriate surge control circuit respectively for the following:
 - If input/output or signal lines within the building are longer than 30 meters.
 - If input/output or signal lines leave the building, regardless the length.
- This instrument is designed for installation in an enclosed instrumentation panel. All high-voltage connections such as power supply terminals must be enclosed in the instrumentation panel to avoid electric shock by operating personnel.
- All precautions described in this manual should be taken to avoid damage to the instrument or equipment.
- All wiring must be in accordance with local codes and regulations.
- All wiring must be completed before power is turned on to prevent electric shock, instrument failure, or incorrect action.

The power must be turned off before repairing work for input break and output failure including replacement of sensor, contactor or SSR, and all wiring must be completed before power is turned on again.
- To prevent instrument damage or failure, protect the power line and the input/output lines from high currents with a protection device such as fuse, circuit breaker, etc.
- Prevent metal fragments or lead wire scraps from falling inside instrument case to avoid electric shock, fire or malfunction.
- Tighten each terminal screw to the specified torque found in the manual to avoid electric shock, fire or malfunction.
- For proper operation of this instrument, provide adequate ventilation for heat dispensation.
- Do not connect wires to unused terminals as this will interfere with proper operation of the instrument.
- Turn off the power supply before cleaning the instrument.
- Do not use a volatile solvent such as paint thinner to clean the instrument. Deformation or discoloration will occur. Use a soft, dry cloth to remove stains from the instrument.
- To avoid damage to instrument display, do not rub with an abrasive material or push front panel with a hard object.
- When high alarm with hold action/re-hold action is used for Alarm function, alarm does not turn on while hold action is in operation. Take measures to prevent overheating which may occur if the control device fails.

NOTICE

- This manual assumes that the reader has a fundamental knowledge of the principles of electricity, process control, computer technology and communications.
- The figures, diagrams and numeric values used in this manual are only for purpose of illustration.
- RKC is not responsible for any damage or injury that is caused as a result of using this instrument, instrument failure or indirect damage.
- RKC is not responsible for any damage and/or injury resulting from the use of instruments made by imitating this instrument.
- Periodic maintenance is required for safe and proper operation of this instrument. Some components have a limited service life, or characteristics that change over time.
- Every effort has been made to ensure accuracy of all information contained herein. RKC makes no warranty expressed or implied, with respect to the accuracy of the information. The information in this manual is subject to change without prior notice.
- No portion of this document may be reprinted, modified, copied, transmitted, digitized, stored, processed or retrieved through any mechanical, electronic, optical or other means without prior written approval from RKC.

CONTENTS

1. OUTLINE.....	1
1.1 Product Outline.....	1
2. SPECIFICATIONS	2
3. CONNECTIONS.....	3
3.1 Connection to PLC and the controller.....	3
4. SETTING.....	5
4.1 Transfer to Setup Setting Mode.....	6
4.2 Address setting.....	7
5. PROFIBUS COMMUNICATIONS.....	8
5.1 PROFIBUS System Configuration	8
5.2 Static Data Read	10
5.3 Data Send/Receive by Dynamic Data Request	21
5.4 Registers Assigned to PLC.....	23
5.5 Cautions for Handling Communication Data.....	24
5.6 Function Number	25
5.6.1 Reference to function number list	25
5.6.2 Function number list.....	26
6. COMMUNICATION DATA DESCRIPTION	45

7. USAGE EXAMPLE	145
7.1 Handling Procedures	145
7.2 System Configuration	146
7.3 Example of Data Assignment	147
7.3.1 Assignment of registers read by static data request	147
7.3.2 Assignment of registers input by dynamic data request.....	149
7.3.3 Assignment of registers output by dynamic data request	150
7.4 Example of Dynamic Data Communication	151
7.4.1 Dynamic data read	151
7.4.2 Dynamic data write.....	152
8. TROUBLESHOOTING	153

1. OUTLINE

This manual describes PROFIBUS specification, wiring, setting, and data instructions for the HA400/900/401/901.

1.1 Product Outline

Digital Controller HA400/900/401/901 (hereafter, called controller) can send and receive data to/from PLCs (programmable controller) conforming to PROFIBUS via PROFIBUS.

The controller supports PROFIBUS-DP protocol. This protocol includes master and slave. The PLC is the master and the controller is the slave.

■ Communication port

The controller has a maximum of two communication ports, but PROFIBUS use only communication port 2, and communication interface is RS-485.

● PLC communication port (Communication 2 function only)

This is a port to be connected to PLC with PROFIBUS.

PLC can connect the maximum 31 controllers.

- ☞ For the specification of connecting PLC, refer to the instruction manual for the used PLC.
- ☞ For PROFIBUS, refer to the home page of PROFIBUS International.
<http://www.profibus.com/>

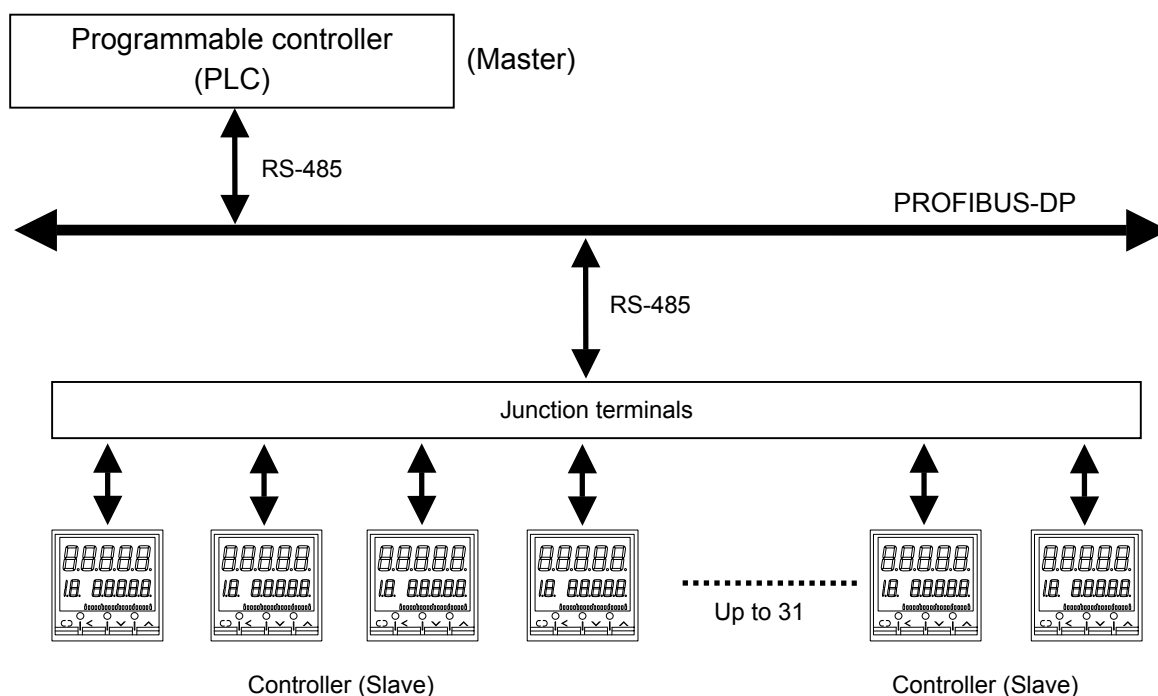

2. SPECIFICATIONS

■ PROFIBUS communication

Interface: Based on RS-485, EIA standard

Protocol: PROFIBUS-DP (EN50170)
Correspond to both static data request and dynamic data request
Static data area: RO (Read only)
Dynamic data area: R/W (Read and Write)

Communication speed: 12 Mbps max.
Communication speed is set as follows:

- A master judges the quality situation of a line, and set it automatically.
- Set it with a sequence program of PLC.

Termination resistor: Connected to terminals

Signal logic:

Signal voltage	Logic
$V(A) - V(B) \geq 2\text{ V}$	0 (SPACE)
$V(A) - V(B) \leq -2\text{ V}$	1 (MARK)

Voltage between V (A) and V (B) is the voltage of (A) terminal for the (B) terminals

3. CONNECTIONS

⚠ WARNING

To prevent electric shock or instrument failure, do not turn on the power until all the wiring is completed.

3.1 Connection to PLC and the Controller

■ Communication terminal number and signal details

Terminal No.	Signal name	Symbol
25	Termination resistor supply voltage (5 V)	VP
26	Receive data/transmission data (plus)	RxD/TxD-P
27	Receive data/transmission data (negative)	RxD/TxD-N
28	Signal ground	DGND

For the connectable connector of the PLC, refer to the instruction manual for the used PLC.

■ Wiring method

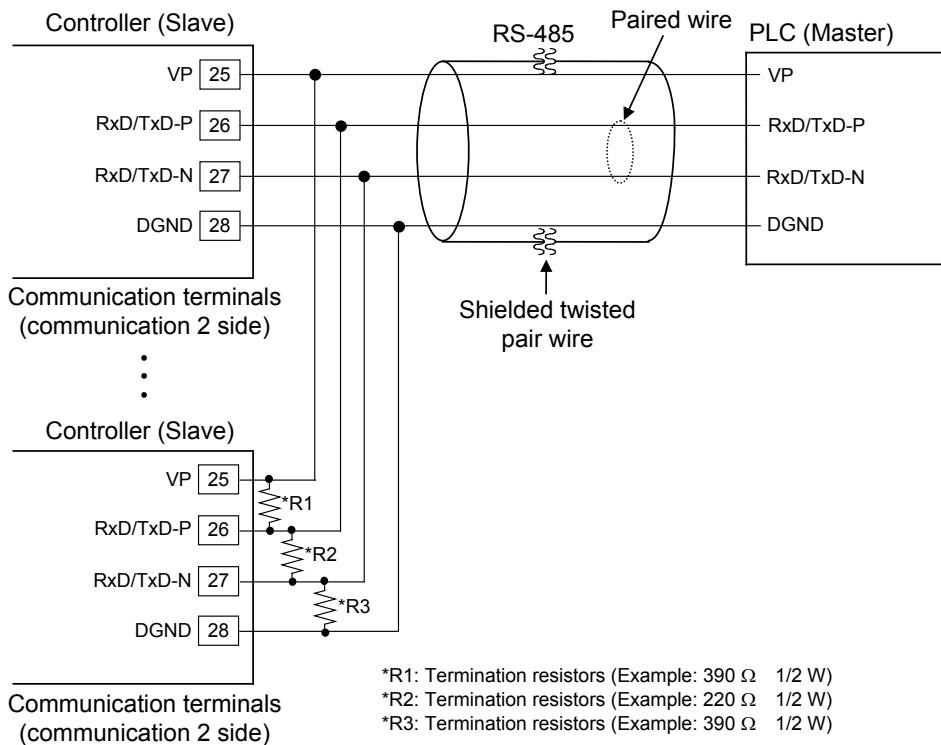

The cable must be provided by the customer.

■ **PROFIBUS cables**

Use the PROFIBUS cable which fitted the following requirement.

- Use the shielded twisted pair wire
- Based on EN50170, European standard (Recommend cable type A)

Cable type A specification

- Impedance: 135 to 165 Ω
- Capacitance: < 30 pF/m
- Loop resistance: 110 Ω /km
- Core diameter: 0.64 mm
- Core cross section: > 0.34 mm²

Maximum cable length by communication speed (For cable type A)

Communication speed (kbps)	9.6	19.2	93.75	187.5	500	1500	12000
Cable length (m)	1200	1200	1200	1000	400	200	100

- Connect the termination resistor to the end of a bus (Refer to below)

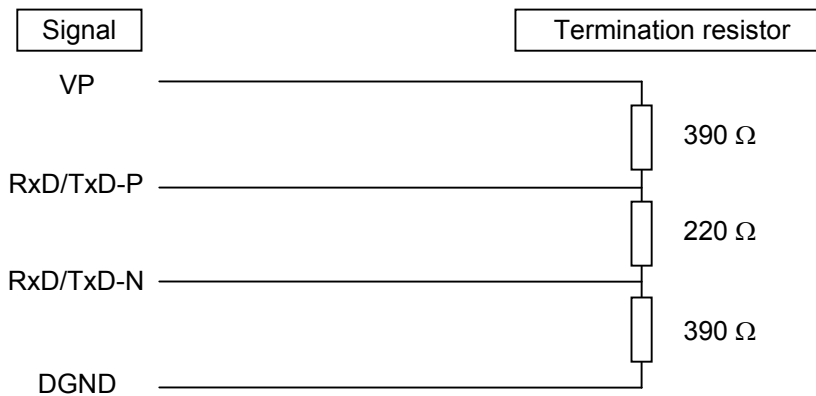

As for the PROFIBUS cable (a connection cable of PLC and Controller), there is a case prepared by a PLC manufacturer.



The details except the above are connected to a home page of PROFIBUS International, and obtain necessary information.

<http://www.profibus.com/>

4. SETTING

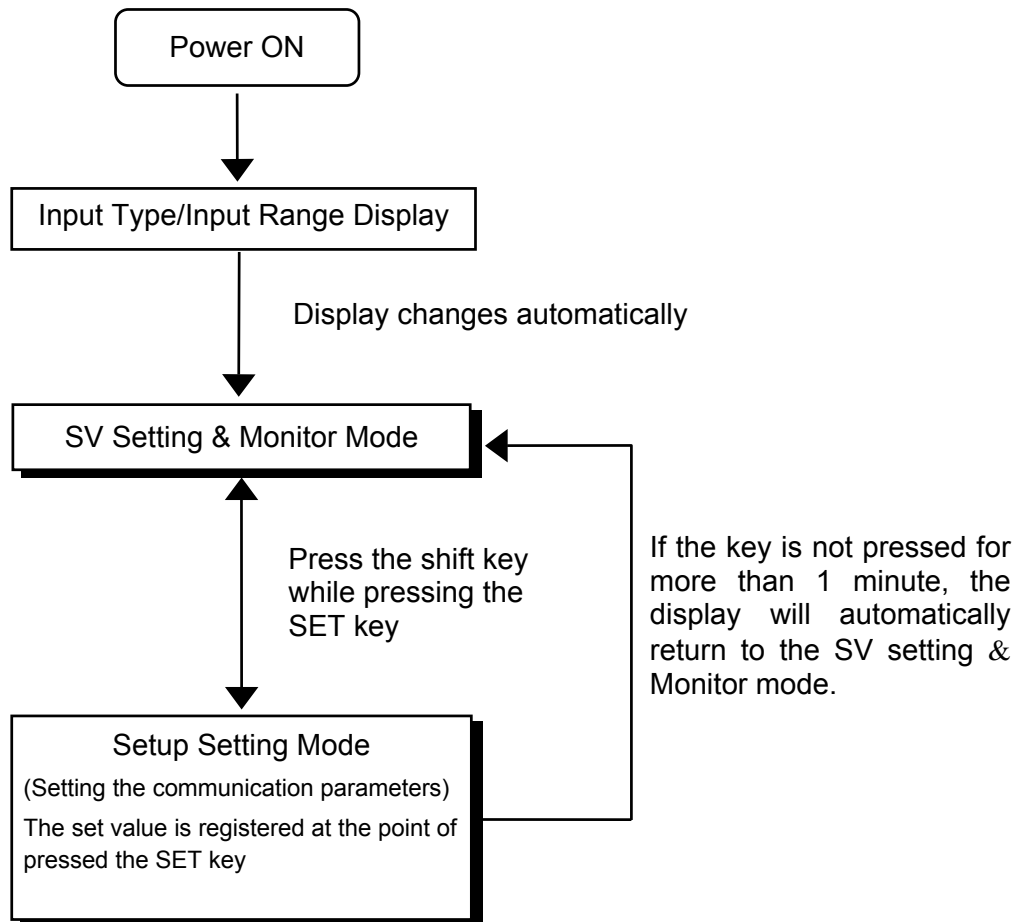

The master communicates with the selected slave by specifying that slave's address number. Each slave must have a unique address number for this data transmission. Set the slave address with the address setting screen prior to operation.

For an address number of the controller, set the device address (slave address) 2 [Add2] in Setup setting mode.





**An address number of the controller always uses it from 1 in succession.
Address setting range: 1 to 126**

4.1 Transfer to Setup Setting Mode

-  The first displayed parameter in the Setup setting mode varies depending on the instrument specification.
-  This section provides explanation, assuming that the first parameter in the Setup setting mode is PV bias (*Pb*).

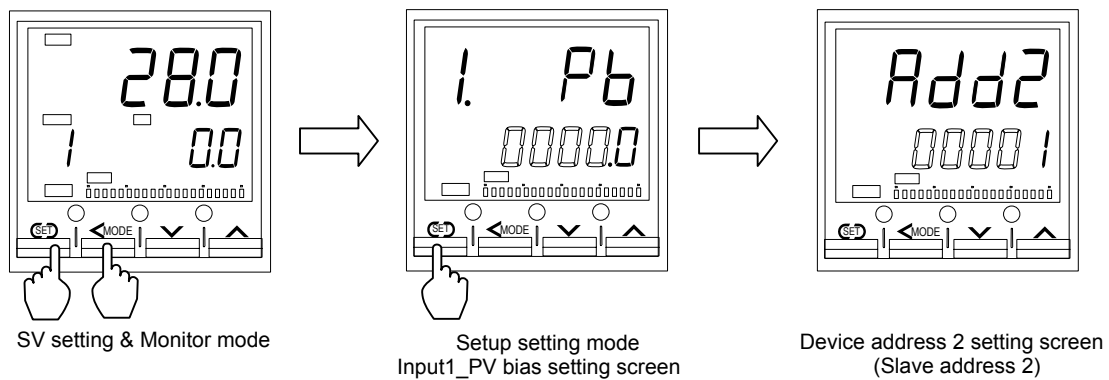
To enter the Setup setting mode, you must be in SV setting & Monitor mode. The first parameter to be displayed will be the Input 1_PV bias, *1. Pb*. Press the SET key several times to change to the device address 2, *Add2*.



-  To exit Setup setting mode, press the shift key while pressing the SET key. The display changes to the SV setting & Monitor mode.
-  HA900/901 is used in the above figures for explanation, but the same setting procedures also apply to HA400/401.

4.2 Address Setting



This item describes when the Communication 2 (PROFIBUS) is used under the 2-input controller.

To select parameters in the Setup setting mode, press the SET key.

The parameters relating to communication are shown below.

Communication 2 (PROFIBUS): Device address 2 (slave address 2), *Add2*

From Input 2_proportional cycle time screen

↓ Press the SET key



Device address 2 [Add2]
(Slave address 2)

↓ Press the SET key

To Set lock level screen

■ Setting procedure

- Device address 2, *Add2*
Operate UP, DOWN and shift key, and input numerals.

■ Store the set value

Press the SET key to store the new value.

After all communication parameters are set, in order to make these values thus set validate perform any of the following operations.

- The power is turned on again.
- The RUN/STOP mode is changed from STOP mode to RUN mode.



A new value will not be stored without pressing SET key after the new value is displayed on the display. No communication using the value changed can be performed even with the SET key pressed.



When the RUN/STOP mode is changed from STOP mode to RUN mode, the controller performs the same operation as that of Power-on.



After a new value has been displayed by using the UP and DOWN keys, the SET key must be pressed within 1 minute, or the new value is not stored and the display will return to the PV1/SV1 monitor screen.



For the RUN/STOP transfer, refer to **HA400/HA900/HA401/HA901 Operation Manual (IMR01N02-E□)**.

5. PROFIBUS COMMUNICATION

5.1 PROFIBUS System Configuration

For system configuration with PROFIBUS-DP protocol, have to offer the communication information about each slave for a master in the form of electronic device data seat (GSD file).

A manufacturer of PLC (master) has prepared configuration tool for a system configuration of PROFIBUS. By combining all GSD files of the slaves to be connected, the configuration tool creates a master parameter record containing all pertinent data for the bus system. The configuration of a PROFIBUS system is enabled by downloading these data to a master.

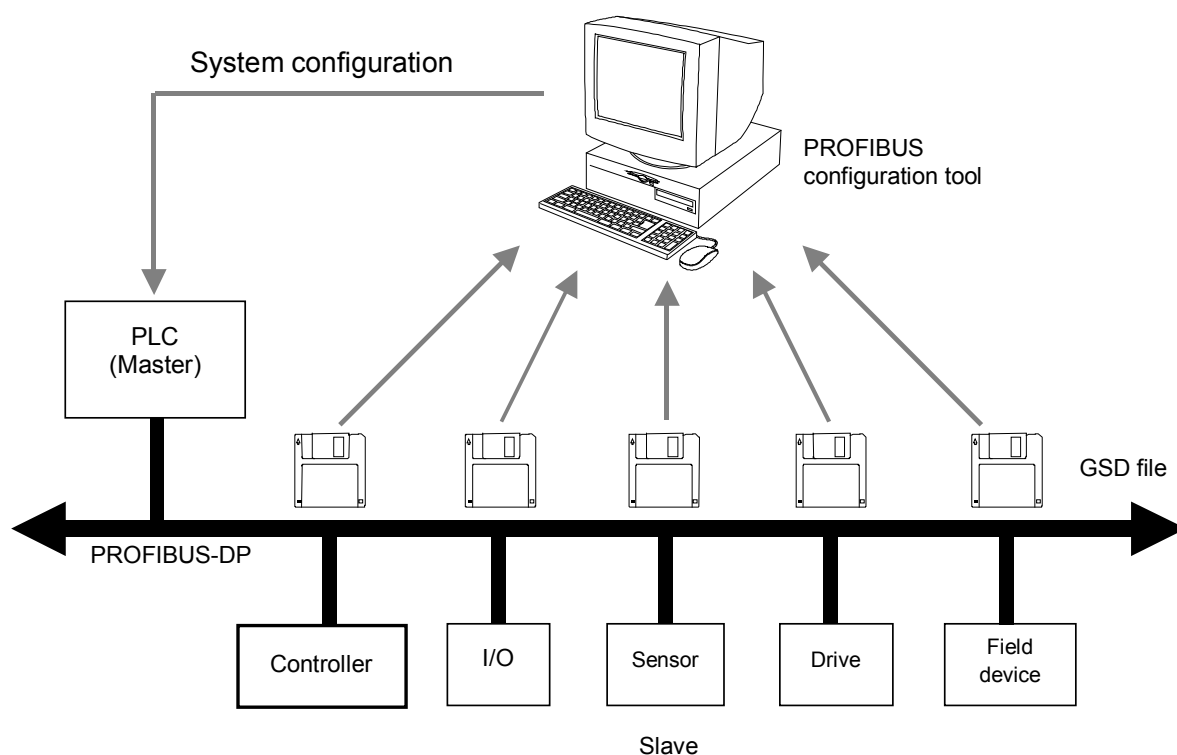

About configuration tool, please ask a manufacturer of a master product.

■ The procedure of system configuration

When a master is PLC, and a slave is Controller, the procedure of system configuration is as follows.

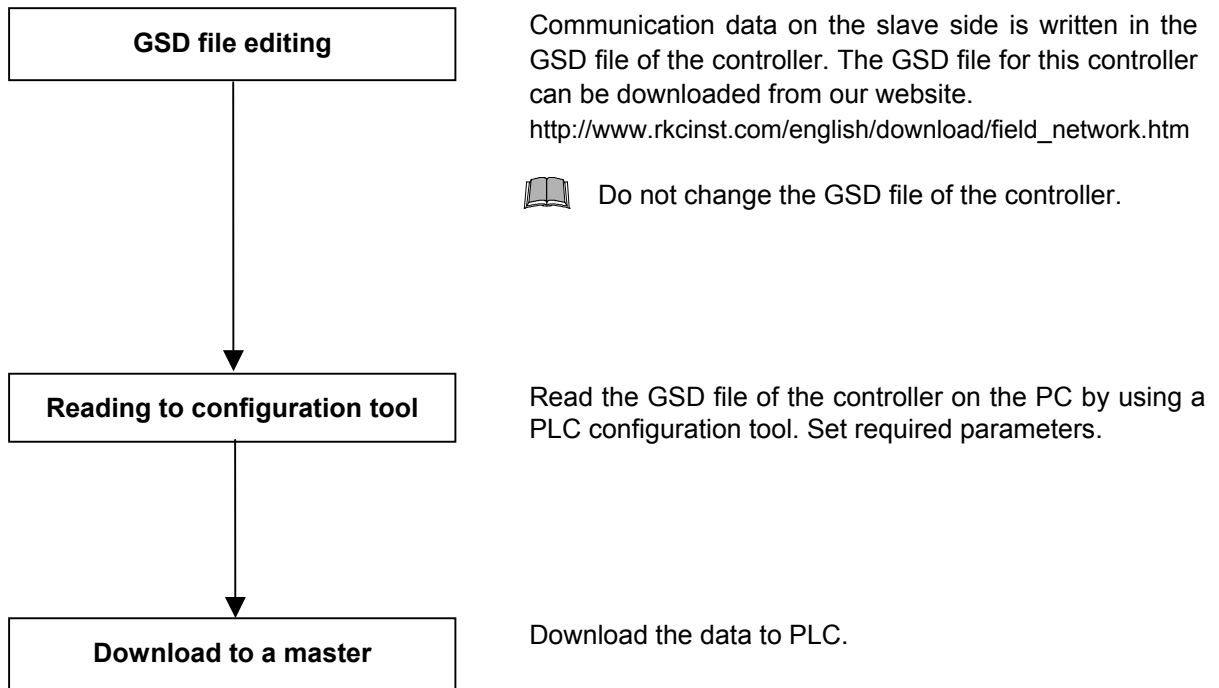

A word of “static data” and “dynamic data” is used in explanation. Use these in the following meaning in this product.

Static data: When a configuration tool read a GSD file, static data is the data that an item of read is decided. And, static data is the data that PLC (a master) always has read.

Dynamic data: Dynamic data is the data that an item of read/write is decided with a sequence program. And, dynamic data is read/write requested data by an event from PLC (a master). PLC (a master) specify data items.

Continued from the previous page.

- Byte 14, Byte 15, Byte 16, Byte 17:
Current transformer 1 (CT1) input value monitor
Data range: 0.0 to 30.0 A or 0.0 to 100.0 A
- Byte 18, Byte 19, Byte 20, Byte 21:
Current transformer 2 (CT2) input value monitor
Data range: 0.0 to 30.0 A or 0.0 to 100.0 A
- Byte 22, Byte 23, Byte 24, Byte 25:
Input 1_set value (SV1) monitor
Data range: Input 1_setting limiter low to Input 1_setting limiter high
- Byte 26, Byte 27, Byte 28, Byte 29:
Input 2_set value (SV2) monitor
Data range: Input 2_setting limiter low to Input 2_setting limiter high
- Byte 30, Byte 31, Byte 32, Byte 33:
Remote input value monitor
Data range: Input 1_setting limiter low to Input 1_setting limiter high
- Byte 34, Byte 35, Byte 36, Byte 37:
Cascade monitor
Data range: Input 2_setting limiter low to Input 2_setting limiter high
- Byte 38, Byte 39, Byte 40, Byte 41:
Input 1_burnout state
Data range: Only Bit 0 in Byte 41 is used.

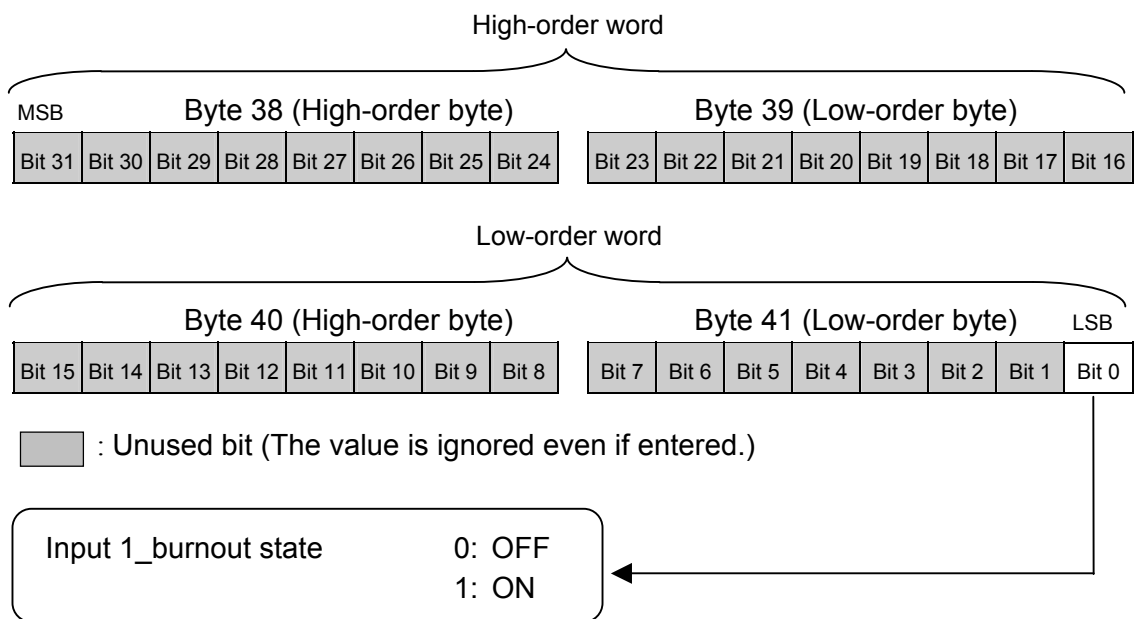

Continued on the next page.

Continued from the previous page.

Byte 42, Byte 43, Byte 44, Byte 45:
 Input 2_ burnout state
 Data range: Only Bit 0 in Byte 45 is used.

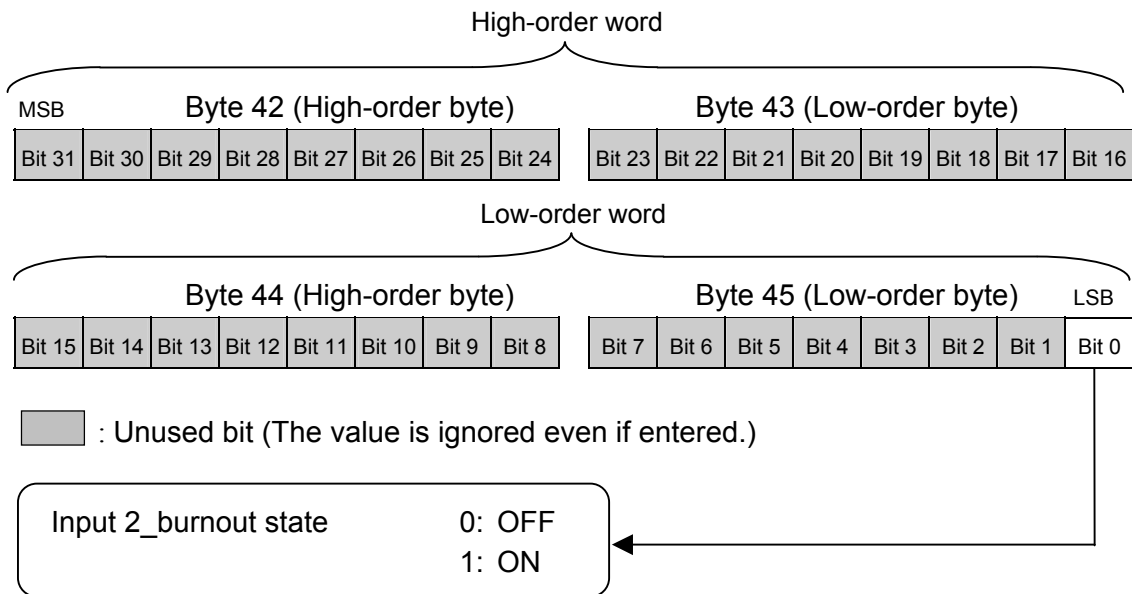

Byte 46, Byte 47, Byte 48, Byte 49:
 Feedback resistance input burnout state
 Data range: Only Bit 0 in Byte 49 is used.

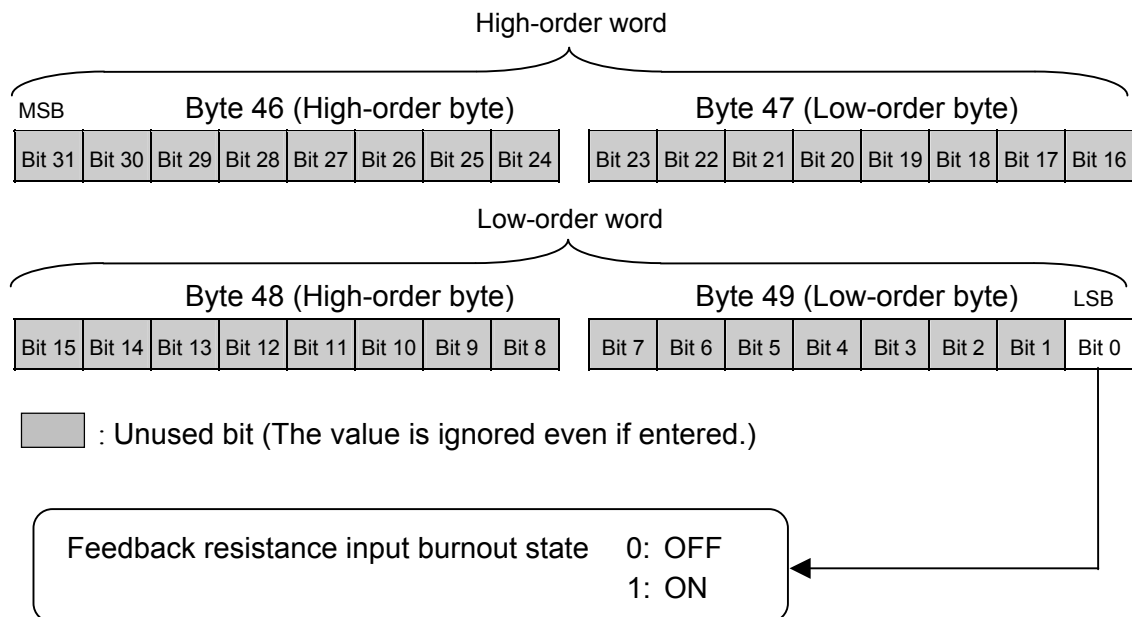

Continued on the next page.

Continued from the previous page.

Byte 50, Byte 51, Byte 52, Byte 53:

Event 1 state

Data range: Only Bit 0 in Byte 53 is used.

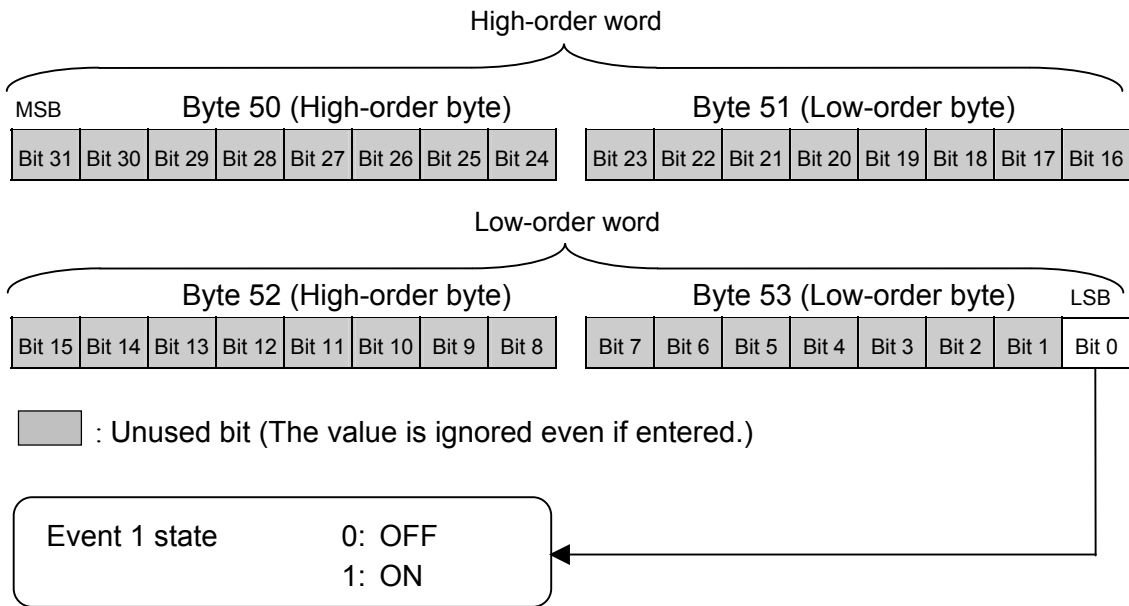

Byte 54, Byte 55, Byte 56, Byte 57:

Event 2 state

Data range: Only Bit 0 in Byte 57 is used.

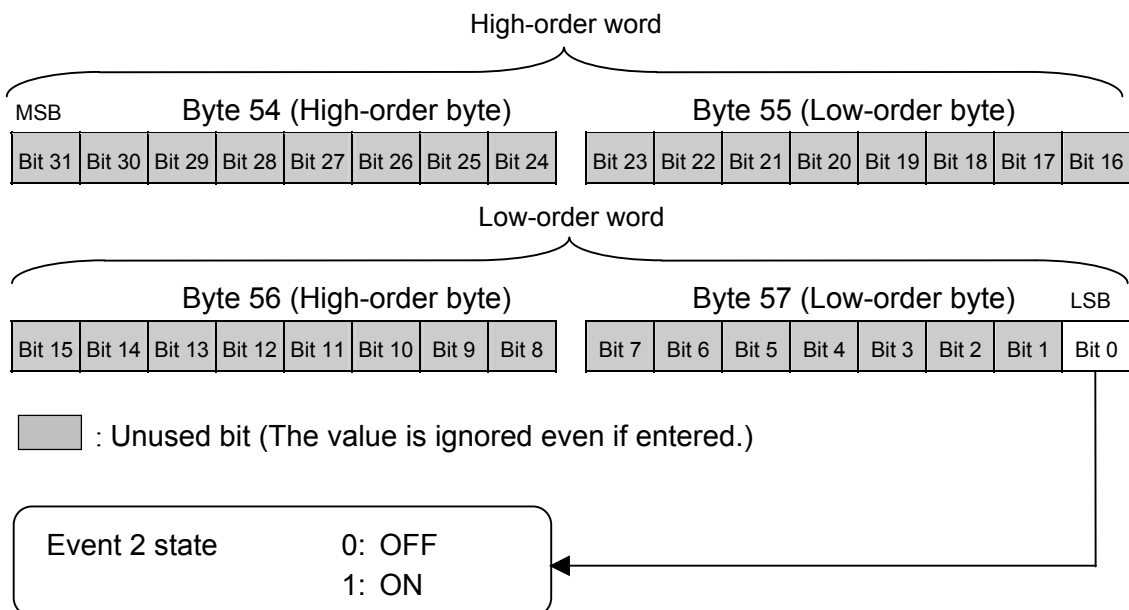

Continued on the next page.

Continued from the previous page.

Byte 58, Byte 59, Byte 60, Byte 61:

Event 3 state

Data range: Only Bit 0 in Byte 61 is used.

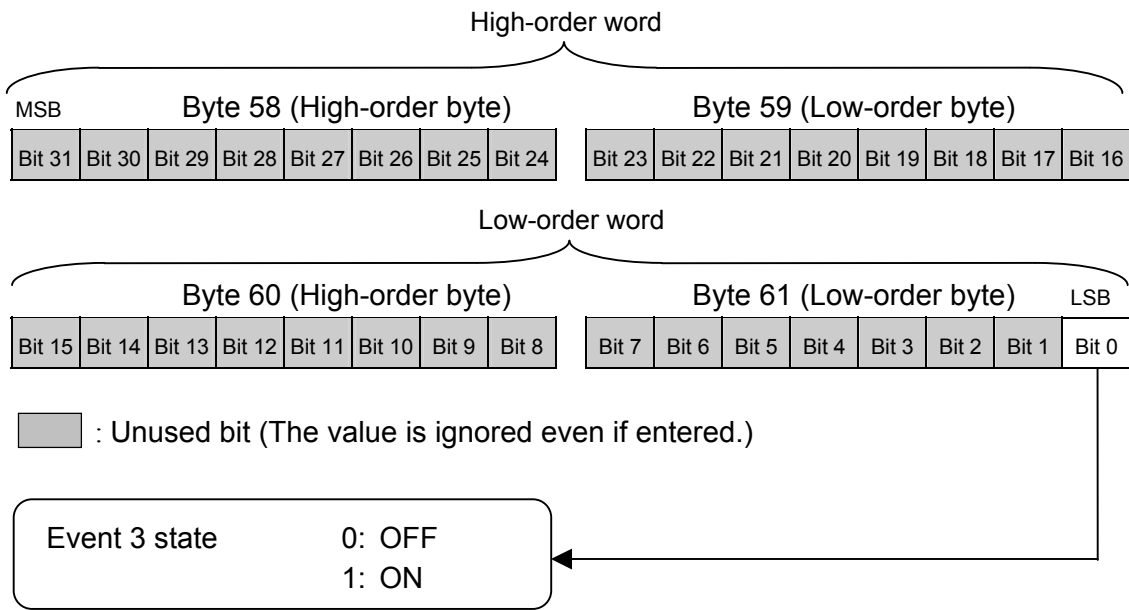

Byte 62, Byte 63, Byte 64, Byte 65:

Event 4 state

Data range: Only Bit 0 in Byte 65 is used.

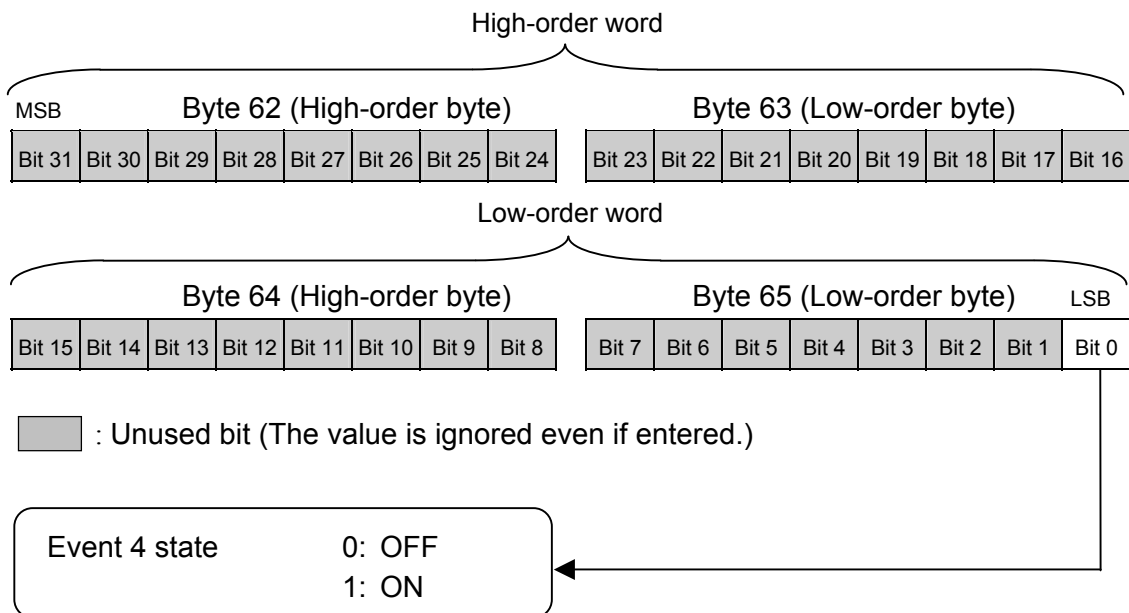

Continued on the next page.

Continued from the previous page.

Byte 66, Byte 67, Byte 68, Byte 69:
 Heater break alarm 1 (HBA1) state
 Data range: Only Bit 0 in Byte 69 is used.

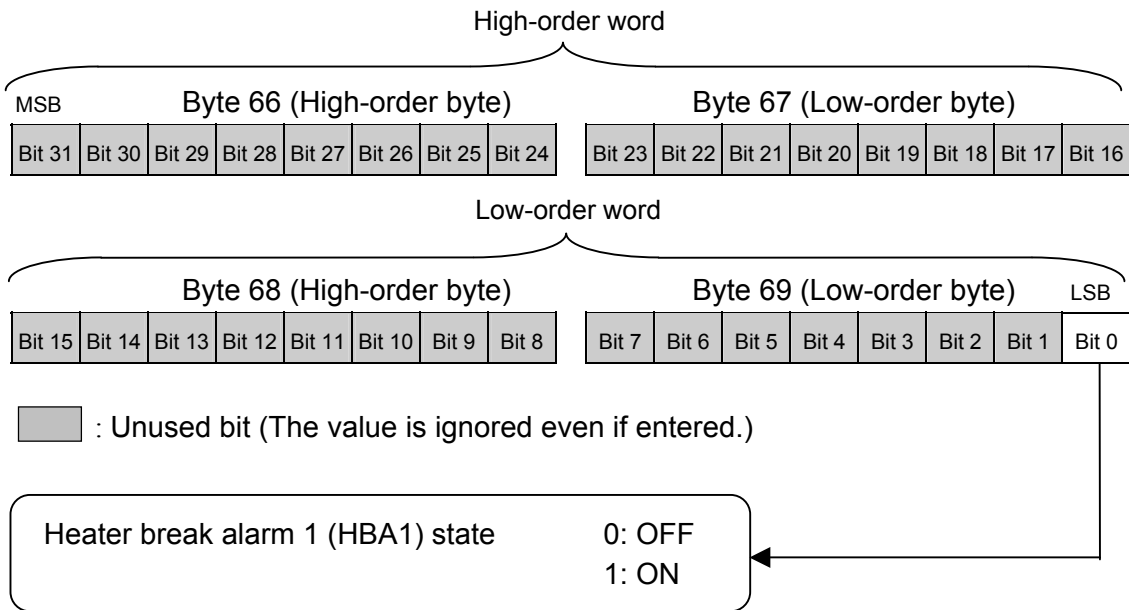

Byte 70, Byte 71, Byte 72, Byte 73:
 Heater break alarm 2 (HBA2) state
 Data range: Only Bit 0 in Byte 73 is used.

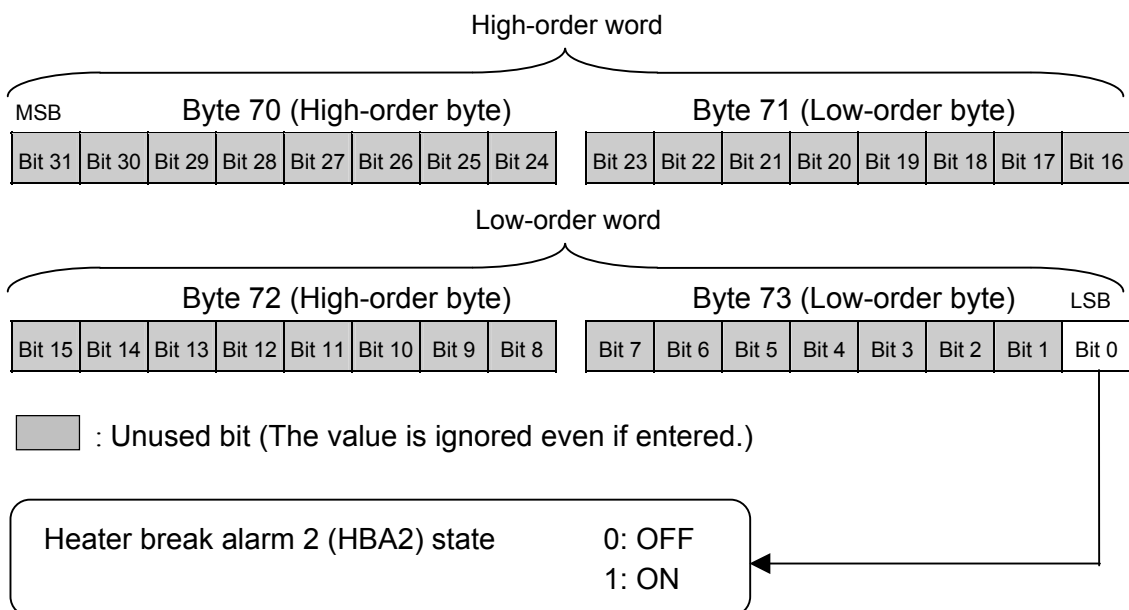

Continued on the next page.

Continued from the previous page.

Byte 74, Byte 75, Byte 76, Byte 77:
Input 1_manipulated output value (MV1)
Data range: -5.0 to +105.0 %

Byte 78, Byte 79, Byte 80, Byte 81:
Input 2_manipulated output value (MV2)
Data range: -5.0 to +105.0 %

Continued on the next page.

Continued from the previous page.

Byte 82, Byte 83, Byte 84, Byte 85:

Error code

Data range: Bit 0 to Bit5, Bit 7 and Bit 11 are used.

(Bit 6, Bit 8 to Bit 10, Bit 12 to Bit 31: Unused)

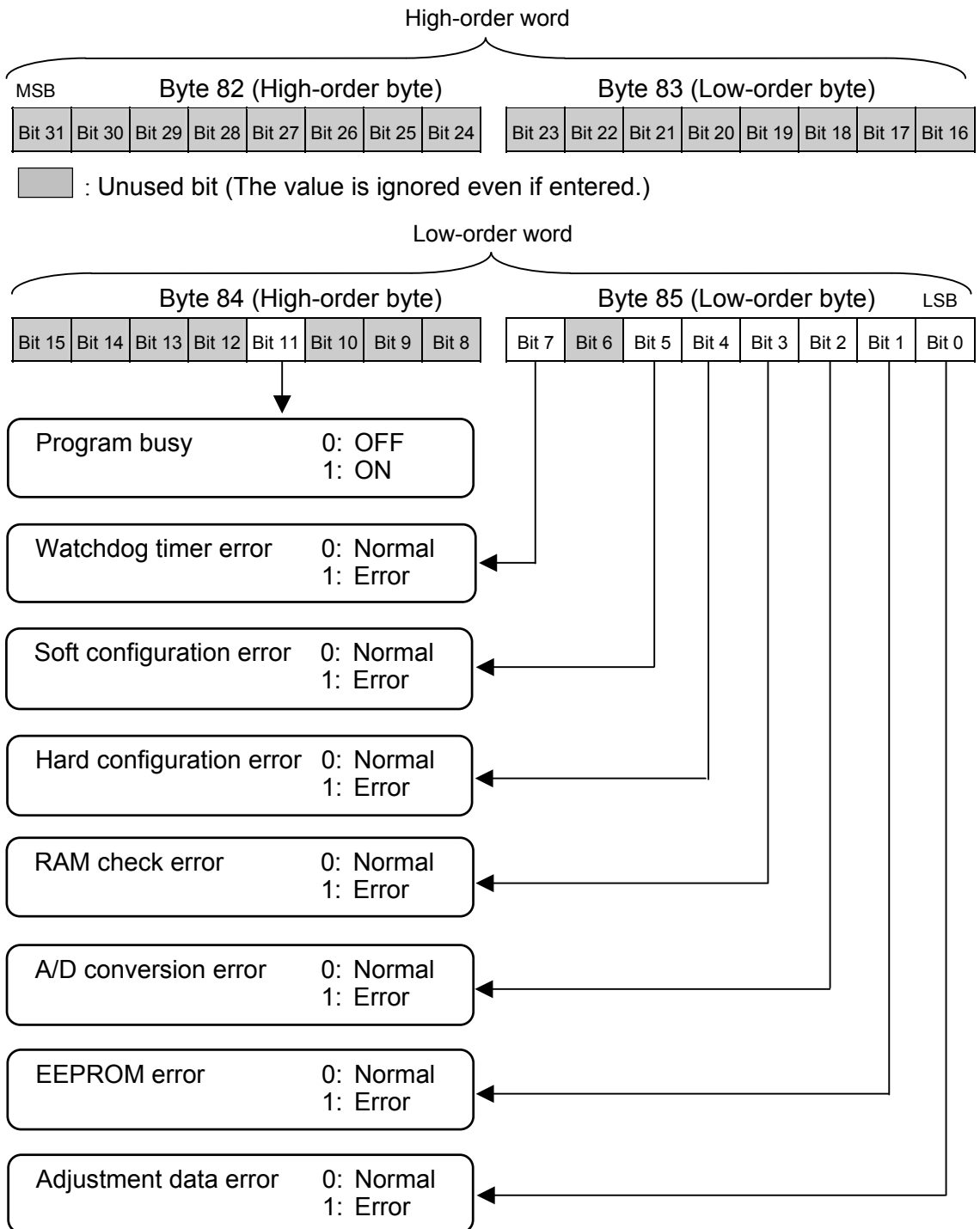

Continued on the next page.

Continued from the previous page.

Byte 86, Byte 87, Byte 88, Byte 89:

Event input (DI) state

Data range: Bit 0 to Bit 6 are used.

(Bit 7 to Bit 31: Unused)

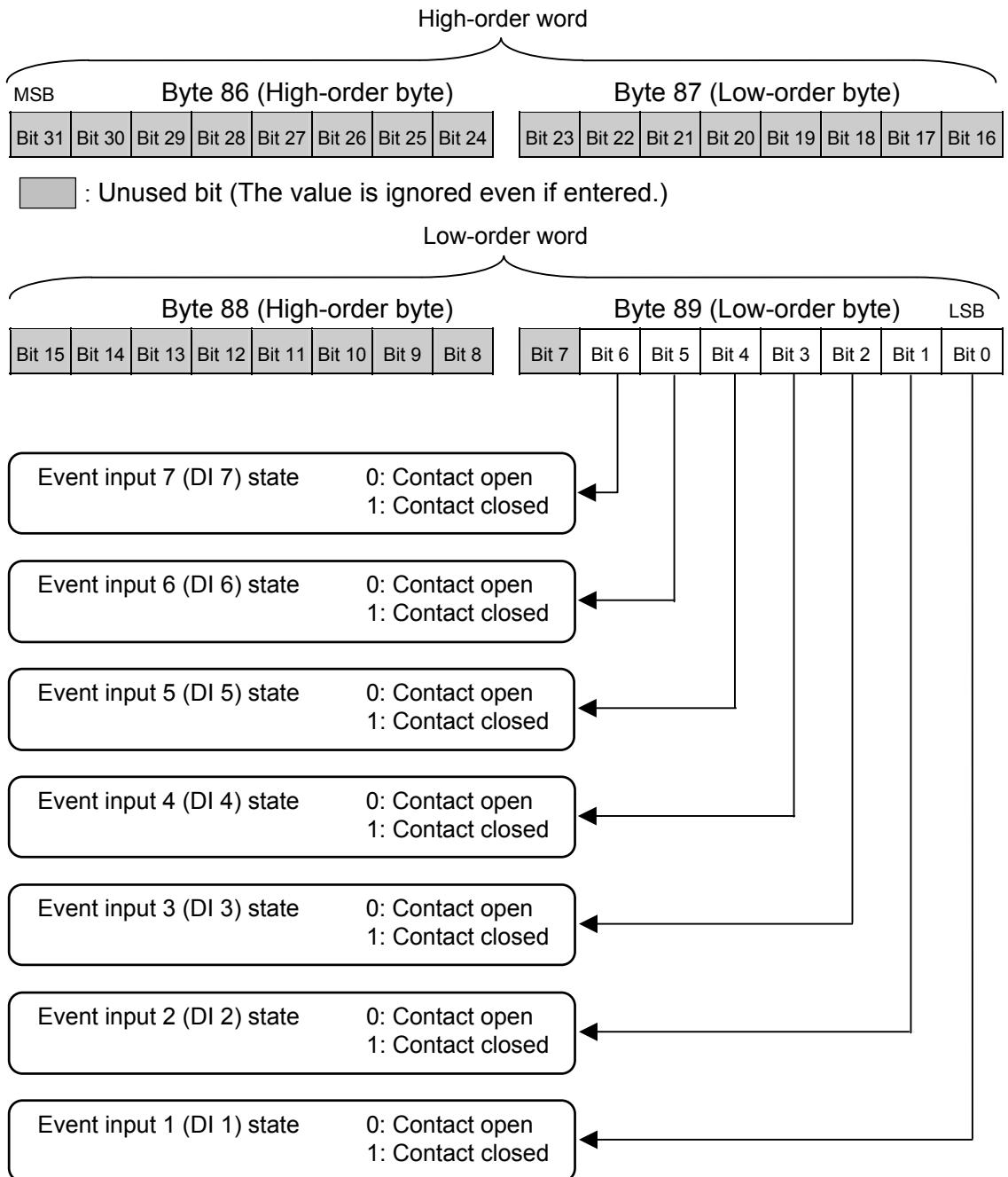

Continued on the next page.

Continued from the previous page.

Byte 90, Byte 91, Byte 92, Byte 93:

Operation mode state

Data range: Bit 0 to Bit 4 are used.

(Bit 5 to Bit 31: Unused)

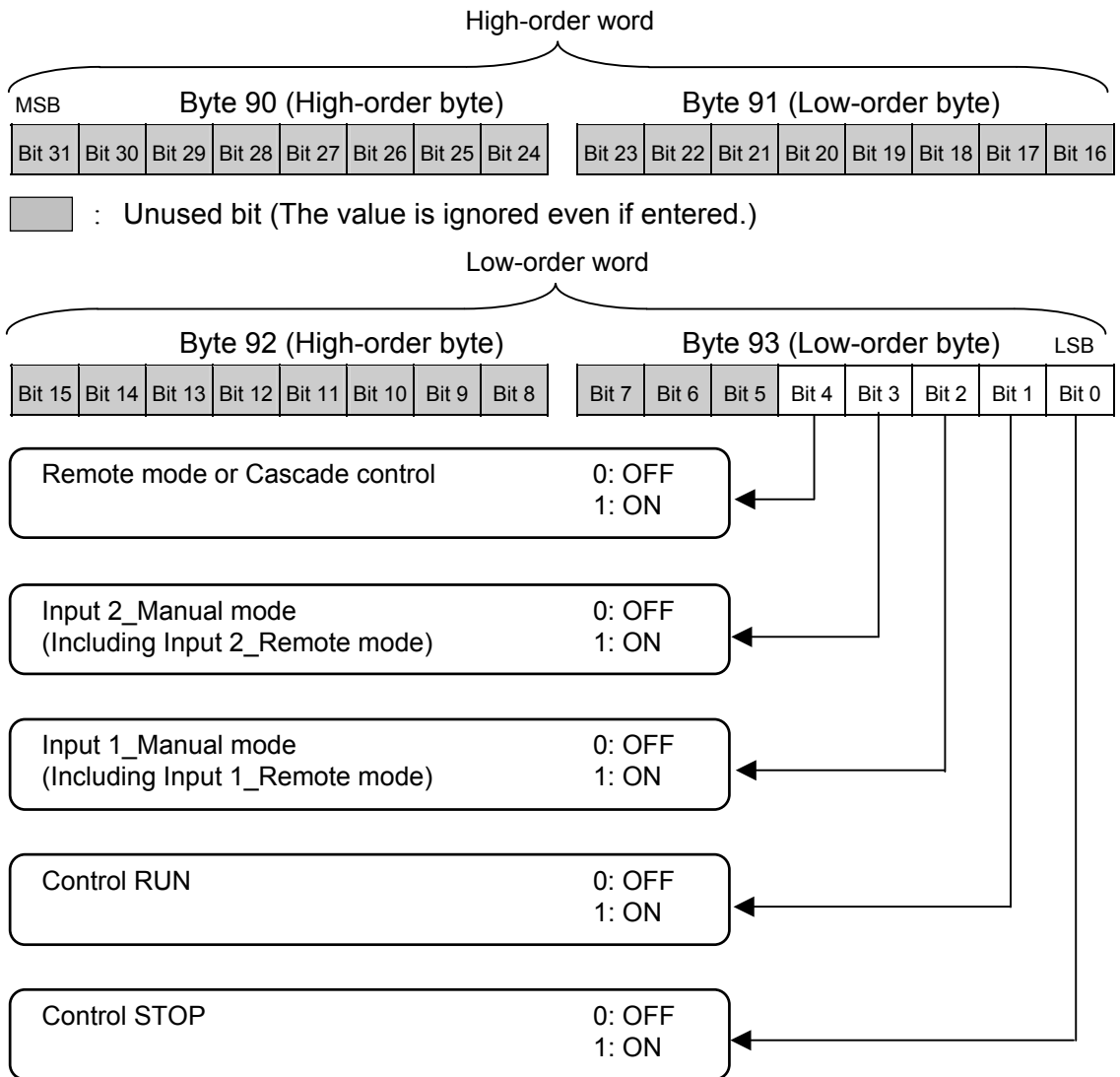

Continued on the next page.

Continued from the previous page.

Byte 94, Byte 95, Byte 96, Byte 97:

Memory area soak time monitor

Data range: 0 minute 00.00 second to 9 minute 59.99 seconds or

0 hour 00 minute 00 second to 9 hours 59 minutes 59 seconds



Memory area soak time monitor is expressed in second unit for PROFIBUS.

0 minute 00.00 second to 9 minutes 59.99 seconds: 0 to 59999 seconds

0 hour 00 minute 00 second to 9 hours 59 minutes 59 seconds: 0 to 35999 seconds

Byte 98 to Byte 119: Unused

5.3 Data Send/Receive by Dynamic Data Request

The register area used for dynamic data request read/write consists of 40 bytes. For dynamic data request, data items consisting of 4 words (8 bytes) per communication item is used for both data send/receive. It is possible to specify up to 5. (Register area: Refer to the following table)

Register area of dynamic data request (Byte)	Details
Byte 0 to Byte 7	Variable area 1 for dynamic data request
Byte 8 to Byte 15	Variable area 2 for dynamic data request
Byte 16 to Byte 23	Variable area 3 for dynamic data request
Byte 24 to Byte 31	Variable area 4 for dynamic data request
Byte 32 to Byte 39	Variable area 5 for dynamic data request

■ Procedure for data read/write request

Procedures are shown below.

1. To make read/write request invalidate (Bit 6 = 1 of Byte 0).
2. To write function codes (Byte 2 and Byte 3)
3. To make read/write request validate (Bit 6 = 0 of Byte 0)

■ Each byte specifications

The specifications for each byte are as follows.

● When sending data from PLC to Controller

Byte 0: Only Bit 7 and Bit 6 are used.

Bit 7: Setting Bit 7 to 0 indicates that the data is for read, while setting Bit 7 to 1 indicates that the data is for write.

Bit 6: Setting Bit 6 to 0 indicates that the Controller accepts the data, while setting Bit 6 to 1 indicates that the Controller ignores the data even if sent.

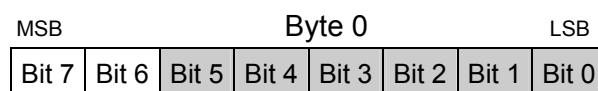

As far as Bit 6 is not set to 0, no data on the Controller side is used.

Set Bit 7 to 1 for data write, while set Bit 7 to 0 for data read.

Continued on the next page.

Continued from the previous page.

Byte 1: This byte enables to check the updated register information at the time of dynamic data read /write request.

 Refer to **7.4 Example of Dynamic Data Communication (P. 151)**.

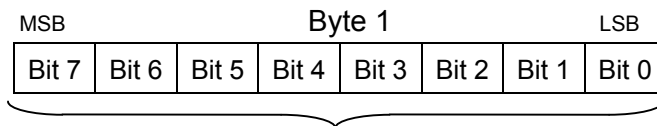

This byte enables to check the updated register information.
Data range: 0 (00000000) to 255 (11111111)

Byte 2, Byte 3: The function code is specified. (Refer to P. 25)

 The function code is a 2-byte code.

 ① High-order byte: Specified memory area 0 to 16 (00H to 10H)

① ② “0” denotes that the control area is specified.

When the function number corresponding to the communication item not included in the area is specified, that area designation is ignored.

② Low-order byte: Function number 0 to 255 (00H to FFH)

Byte 4, Byte 5, Byte 6, Byte 7:

The variable value is specified.

If MSB (Bit 7) in Byte 0 is set to 1, Byte 4 through Byte 7 are used to specify write data. If MSB (Bit 7) in Byte 0 is set to 0, data in Byte 4 through Byte 7 will be ignored.

 If there is an error in the setting change at the time of write request, the present value returns to the value before write request.

● When receiving data by PLC from Controller

Byte 0: Unused

Byte 1: If the controller side recognized a change in the read write attribute, a value different from the value at the time of the above change recognition is returned.

Byte 2, Byte 3: The function code (Refer to P. 25)

Byte 4, Byte 5, Byte 6, Byte 7:

For data read, the value read out the controller. For data write, the value written to the controller when ACK is returned, or the infinite value when NAK is returned.

 Data items consisting of 2 words are read/write in order of high-order and low-order words.

5.4 Registers Assigned to PLC

The GSD file is read to the PLC configuration tool, the register area corresponding to the number of words used for the controller are automatically reserved. In addition, the areas in two registers for dynamic data request and static data request read are independently reserved. Further, the first 2 bytes for static data request read in the register assigned for PLCs are used for controller status information, while the second byte in the register for dynamic data request, for checking the updated registered information.

■ The first 2 bytes for static data request read

Byte 0, Byte 1: Controller status information

Data range: Only Bit 0 and Bit 1 in Byte 1 are used.

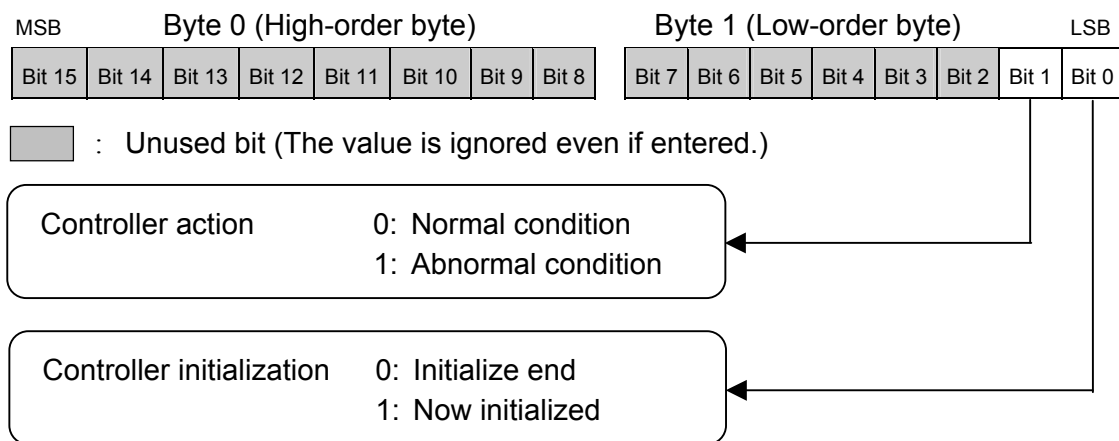

If there is an error in the setting change at the time of write request, the present value returns to the value before write request.

■ The second byte in the register for dynamic data request

Byte 1: This byte enables to check the updated register information.

☞ Refer to **7.4 Example of Dynamic Data Communication (P. 151)**.

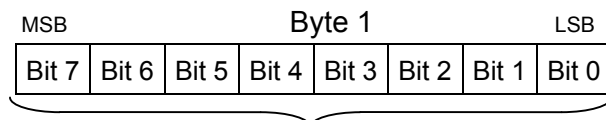

This byte enables to check the updated register information.
Data range: 0 (00000000) to 255 (11111111)

5.5 Caution for Handling Communication Data

- (1) In this communication, the variable is handled as 2 words (4 bytes) data.
- (2) In this communication, the register area (high-order and low-order areas) consisting of 2 words (4 bytes) are used for each communication item.
- (3) Data items consisting of 2 words are read/write in order of high-order and low-order words.
- (4) Numeric data values obtained via communication with the Controller include those with and without decimal points and also those with minus signs.

- For numeric data value without decimal point

If there is no decimal point, the value is processed as it is. In parameters which only have ON or OFF status, 1 = ON, 0 = OFF.

[Example]

A signal wire for Input 1 is disconnected and the burnout state occurs.

→ Read value corresponding to function number 0A [Input 1_burnout state]:

1 (Hexadecimal number: 0001H)

- For numeric data value with decimal point

The decimal point is omitted.

[Example]

The PV display unit on the controller displays an Input 1_measured value (PV1) of 120.5 °C.

→ Read value corresponding to function number 01 [Input 1_measured value (PV1)]:

1205 (Hexadecimal number: 04B5H)

- For numeric data value with minus sign

The value is expressed as a 2's complement value which is obtained by subtracting the minus value from the hexadecimal number 10000H.

[Example 1]

The PV display unit on the controller displays an Input 1_measured value (PV1) of -1 °C.

→ Read value corresponding to function number 01 [Input 1_measured value (PV1)]:

Hexadecimal number: FFFFH

(10000H - 1 = FFFFH)

[Example 2]

The PV display unit on the controller displays an Input 1_measured value (PV1) of -2.5 °C.

→ Read value corresponding to function number 01 [Input 1_measured value (PV1)]:

Hexadecimal number: FFE7H

(10000H - 25 = 10000H - 19H = FFE7H)



The original minus value can be found by revising the word value to the INT value on the sequence program side.

5.6 Function Number

5.6.1 Reference to function number list

A list of function numbers is for controller data items corresponding to dynamic data request by PROFIBUS.

(1) ↓	(2) ↓	(3) ↓	(4) ↓	(5) ↓	(6) ↓
Function number	Name	Attribute	Data range	Factory set value	Reference page
01	Input 1_measured value (PV1) monitor	RO	Input 1_input scale low to Input 1_input scale high	—	P. 47
02	Input 2_measured value (PV2) monitor	RO	Input 2_input scale low to Input 2_input scale high	—	P. 47
03	Feedback resistance input value monitor	RO	0.0 to 100.0 %	—	P. 47

(1) **Function number:** The function number is the communication item number to specify with sequence program when carry out read/write of data.



The function code is a 2-byte code.



① High-order byte: Specified memory area 0 to 16 (00H to 10H)



“0” denotes that the control area is specified.

When the function number corresponding to the communication item not included in the area is specified, that area designation is ignored.

② Low-order byte: Function number 0 to 255 (00H to FFH)

(2) **Name:** Communication data name is written.

(3) **Attribute:** RO: Only reading data is possible.
Direction: Slave (Controller) → Master (PLC)
R/W: Reading and writing data is possible.
Direction: Slave (Controller) ↔ Master (PLC)

(4) **Data range:** The reading range or writing range of communication data is written.

(5) **Factory set value:** The factory set value of communication data is written.

(6) **Reference page:** The reference page of communication item is written.

5.6.2 Function number list

Function number	Name	Attribute	Data range	Factory set value	Reference page
01	Input 1_measured value (PV1) monitor	RO	Input 1_input scale low to Input 1_input scale high	—	P. 47
02	Input 2_measured value (PV2) monitor	RO	Input 2_input scale low to Input 2_input scale high	—	P. 47
03	Feedback resistance input value monitor	RO	0.0 to 100.0 %	—	P. 47
04	Current transformer input value 1 (CT1) monitor	RO	0.0 or 30.0 A or 0.0 to 100.0 A	—	P. 48
05	Current transformer input value 2 (CT2) monitor	RO		—	P. 48
06	Input 1_set value (SV1) monitor	RO	Input 1_setting limiter low to Input 1_setting limiter high	—	P. 48
07	Input 2_set value (SV2) monitor	RO	Input 2_setting limiter low to Input 2_setting limiter high	—	P. 48
08	Remote input value monitor	RO	Input 1_setting limiter low to Input 1_setting limiter high	—	P. 49
09	Cascade monitor	RO	Input 2_setting limiter low to Input 2_setting limiter high	—	P. 49
0A	Input 1_burnout state	RO	0: OFF 1: ON	—	P. 50
0B	Input 2_burnout state	RO		—	P. 50
0C	Feedback resistance input burnout state	RO	0: OFF 1: ON	—	P. 51
0D	Event 1 state	RO	0: OFF 1: ON	—	P. 52
0E	Event 2 state	RO		—	P. 52
0F	Event 3 state	RO		—	P. 52
10	Event 4 state	RO		—	P. 52
11	Heater break alarm 1 (HBA1) state	RO	0: OFF 1: ON	—	P. 53
12	Heater break alarm 2 (HBA2) state	RO		—	P. 53
13	Input 1_manipulated output value (MV1) monitor	RO	-5.0 to +105.0 %	—	P. 54
14	Input 2_manipulated output value (MV2) monitor	RO		—	P. 54

Continued on the next page.

Continued from the previous page.

Function number	Name	Attribute	Data range	Factory set value	Reference page
15	Error code	RO	Bit data Bit 0: Adjustment data error Bit 1: EEPROM error Bit 2: A/D conversion error Bit 3: RAM check error Bit 4: Hardware configuration error Bit 5: Software configuration error Bit 6: Unused Bit 7: Watchdog timer error Bit 8 to Bit 10: Unused Bit 11: Program busy Bit 12 to Bit 31: Unused Data 0: OFF 1: ON [Decimal number: 0 to 4095]	—	P. 55
16	Event input (DI) state	RO	Bit data Bit 0: DI 1 state Bit 1: DI 2 state Bit 2: DI 3 state Bit 3: DI 4 state Bit 4: DI 5 state Bit 5: DI 6 state Bit 6: DI 7 state Bit 7 to Bit 31: Unused Data 0: Contact open 1: Contact closed [Decimal number: 0 to 127]	—	P. 56
17	Operation mode state	RO	Bit data Bit 0: Control STOP Bit 1: Control RUN Bit 2: Input 1_Manual mode (Including Input 1_Remote mode) Bit 3: Input 2_Manual mode (Including Input 2_Remote mode) Bit 4: Remote mode or Cascade control Bit 5 to Bit 31: Unused Data 0: OFF 1: ON [Decimal number: 0 to 31]	—	P. 57

Continued on the next page.

Continued from the previous page.

 : Communication items relatd to multi-memory area function

Function number	Name	Attribute	Data range	Factory set value	Reference page
18	Memory area soak time monitor	RO	0 minute 00.00 second to 9 minutes 59.99 seconds or 0 hour 00 minute 00 second to 9 hours 59 minutes 59 seconds	—	P. 58
19	Input 1_PID/AT transfer	R/W	0: PID control 1: Autotuning (AT)	0	P. 58
1A	Input 2_PID/AT transfer	R/W		0	P. 58
1B	Input 1_Auto/Manual transfer	R/W	0: Auto mode 1: Manual mode	0	P. 60
1C	Input 2_Auto/Manual transfer	R/W		0	P. 60
1D	Remote/Local transfer	R/W	0: Local mode 1: Remote mode or Cascade control	0	P. 60
1E	RUN/STOP transfer	R/W	0: Control RUN 1: Control STOP	0	P. 61
1F	Memory area selection	R/W	1 to 16	1	P. 61
20	Event 1 set value	R/W	Deviation: –Input span to +Input span Process/SV: Input scale low to Input scale high	50.0	P. 62
21	Event 2 set value	R/W		50.0	P. 62
22	Event 3 set value	R/W		50.0	P. 62
23	Control loop break alarm 1 (LBA1) time	R/W	0 to 7200 seconds 0: OFF (Unused)	480	P. 63
24	LBA1 deadband	R/W	0.0 to Input span (Varies with the setting of the Decimal point position)	0.0	P. 63
25	Event 4 set value	R/W	Deviation: –Input span to +Input span Process/SV: Input scale low to Input scale high	50.0	P. 62
26	Control loop break alarm 2 (LBA2) time	R/W	0 to 7200 seconds 0: OFF (Unused)	480	P. 63
27	LBA2 deadband	R/W	0.0 to Input span (Varies with the setting of the Decimal point position)	0.0	P. 63
28	Input 1_set value (SV1)	R/W	Input 1_setting limiter low to Input 1_setting limiter high	0.0	P. 66
29	Input 1_proportional band	R/W	TC/RTD inputs: 0 (0.0, 0.00) to Input span Voltage/Current inputs: 0.0 to 1000.0 % of input span (0, 0.0 or 0.00: ON/OFF action)	30.0	P. 66

Continued on the next page.

Continued from the previous page.

	: Communication items relatd to multi-memory area function
--	--

Function number	Name	Attribute	Data range	Factory set value	Reference page
2A	Input 1_integral time	R/W	0 to 3600 seconds, 0.0 to 3600.0 seconds or 0.00 to 360.00 seconds * (0, 0.0, or 0.00: PD action) * Varies with the setting of the Integral/Derivative time decimal point position selection.	240.00	P. 67
2B	Input 1_derivative time	R/W	0 to 3600 seconds, 0.0 to 3600.0 seconds or 0.00 to 360.00 seconds * (0, 0.0, or 0.00: PI action) * Varies with the setting of the Integral/Derivative time decimal point position selection.	60.00	P. 67
2C	Input 1_control response parameter	R/W	0: Slow 1: Medium 2: Fast	0	P. 68
2D	Unused	—	—	—	—
2E	Input 2_set value (SV2)	R/W	Input 2_setting limiter low to Input 2_setting limiter high	0.0	P. 66
2F	Input 2_proportional band	R/W	TC/RTD inputs: 0 (0.0, 0.00) to Input span Voltage/Current inputs: 0.0 to 1000.0 % of input span (0, 0.0 or 0.00: ON/OFF action)	30.0	P. 66
30	Input 2_integral time	R/W	0 to 3600 seconds, 0.0 to 3600.0 seconds or 0.00 to 360.00 seconds * (0, 0.0, or 0.00: PD action) * Varies with the setting of the Integral/Derivative time decimal point position selection.	240.00	P. 67
31	Input 2_derivative time	R/W	0 to 3600 seconds, 0.0 to 3600.0 seconds or 0.00 to 360.00 seconds * (0, 0.0, or 0.00: PI action) * Varies with the setting of the Integral/Derivative time decimal point position selection.	60.00	P. 67
32	Input 2_control response parameter	R/W	0: Slow 1: Medium 2: Fast	0	P. 68

Continued on the next page.

Continued from the previous page.

 : Communication items relatd to multi-memory area function

Function number	Name	Attribute	Data range	Factory set value	Reference page
33	Unused	—	—	—	—
34	Input 1_setting change rate limiter (up)	R/W	0.0 to Input span/unit time * 0.0: OFF (Unused)	0.0	P. 69
35	Input 1_setting change rate limiter (down)	R/W	(Varies with the setting of the Decimal point position)	0.0	P. 69
36	Input 2_setting change rate limiter (up)	R/W	* Unit time: 60 seconds (factory set value)	0.0	P. 69
37	Input 2_setting change rate limiter (down)	R/W		0.0	P. 69
38	Area soak time	R/W	0 minute 00.00 second to 9 minutes 59.99 seconds or 0 hour 00 minute 00 second to 9 hours 59 minutes 59 seconds	0.00.00	P. 71
39	Link area number	R/W	0 to 16 0: OFF (No link)	0	P. 72
3A	Heater break alarm 1 (HBA1) set value	R/W	0.0 or 30.0 A or 0.0 to 100.0 A 0.0: Not used	0.0	P. 73
3B	Heater break alarm 2 (HBA2) set value	R/W		0.0	P. 73
3C	Input 1_PV bias	R/W	–Input span to +Input span	0	P. 75
3D	Input 1_PV digital filter	R/W	0.00 to 10.00 seconds 0.00: OFF (Unused)	HA400/900: 0.00 HA401/901: 1.00	P. 76
3E	Input 1_PV ratio	R/W	0.500 to 1.500	1.000	P. 76
3F	Input 1_PV low input cut-off	R/W	0.00 to 25.00 % of input span	0.00	P. 77
40	Input 1_proportional cycle time	R/W	0.1 to 100.0 seconds	Relay contact output: 20.0 seconds Voltage pulse output and triac output: 2.0 seconds	P. 78
41	Input 1_manual output value	R/W	Input 1_output limiter low to Input 1_output limiter high	0.0	P. 78
42	Input 2_PV bias	R/W	–Input span to +Input span	0	P. 75
43	Input 2_PV digital filter	R/W	0.00 to 10.00 seconds 0.00: OFF (Unused)	HA400/900: 0.00 HA401/901: 1.00	P. 76
44	Input 2_PV ratio	R/W	0.500 to 1.500	1.000	P. 76

Continued on the next page.

Continued from the previous page.

Function number	Name	Attribute	Data range	Factory set value	Reference page
45	Input 2_ PV low input cut-off	R/W	0.00 to 25.00 % of input span	0.00	P. 77
46	Input 2_ proportional cycle time	R/W	0.1 to 100.0 seconds	Relay contact output: 20.0 seconds Voltage pulse output and triac output: 2.0 seconds	P. 78
47	Input 2_ manual output value	R/W	Input 2_ output limiter low to Input 2_ output limiter high	0.0	P. 78
48	Set lock level	R/W	Bit data Bit 0: Lock only setting items other than SV and events (EV1 to EV4). Bit 1: Lock only events (EV1 to EV4). Bit 2: Lock only set value (SV). Bit 3 to Bit 31: Unused Data 0: Unlock 1: Lock [Decimal number: 0 to 7]	0	P. 79
49	EEPROM storage state	RO	0: The content of the EEPROM does not coincide with that of the RAM. 1: The content of the EEPROM coincides with that of the RAM.	—	P. 80
4A	EEPROM storage mode	R/W	0: Set values are store to the EEPROM when set values are changed. 1: Not set values are store to the EEPROM when set values are changed.	0	P. 80
4B	Heater break determination point 1	R/W	0.0 to 100.0 % of heater break alarm 1 (HBA1) set value (0.0: Heater break determination is invalidated)	30.0	P. 81
4C	Heater melting determination point 1	R/W	0.0 to 100.0 % of heater break alarm 1 (HBA1) set value (0.0: Heater melting determination is invalidated)	30.0	P. 82

Continued on the next page.

Continued from the previous page.

Function number	Name	Attribute	Data range	Factory set value	Reference page
4D	Heater break determination point 2	R/W	0.0 to 100.0 % of heater break alarm 2 (HBA2) set value (0.0: Heater break determination is invalidated)	30.0	P. 81
4E	Heater melting determination point 2	R/W	0.0 to 100.0 % of heater break alarm 2 (HBA2) set value (0.0: Heater melting determination is invalidated)	30.0	P. 82
4F • • 63	Unused	—	—	—	—
64	STOP display selection	R/W	0: Displays on the measured value (PV1/PV2) unit 1: Displays on the set value (SV) unit	0	P. 83
65	Bar graph display selection	R/W	0: No display 1: Input 1_manipulated output value (MV) 2: Input 1_measured value (PV) 3: Input 1_set value (SV) 4: Input 1_deviation value 5: Feedback resistance input value (POS) 6: Input 2_manipulated output value (MV) 7: Input 2_measured value (PV) 8: Input 2_set value (SV) 9: Input 2_deviation value	0	P. 84
66	Bar graph resolution setting	R/W	1 to 100 digits/dot	100	P. 85
67	Unused	—	—	—	—
68	Auto/Manual transfer key operation selection (A/M)	R/W	0: Unused 1: Auto/Manual transfer for input 1 2: Auto/Manual transfer for input 2 3: Auto/Manual transfer for input 1 and input 2	3	P. 85
69	Remote/Local transfer key operation selection (R/L)	R/W	0: Unused 1: Remote/Local transfer	1	P. 86
6A	RUN/STOP transfer key operation selection (R/S)	R/W	0: Unused 1: RUN/STOP transfer	1	P. 86

Continued on the next page.

Continued from the previous page.

Function number	Name	Attribute	Data range	Factory set value	Reference page
6B	Input 1_input type selection	R/W	TC input 0: K -200 to +1372 °C -328.0 to +2501.6 °F 1: J -200 to +1200 °C -328.0 to +2192.0 °F 2: R -50 to +1768 °C -58.0 to +3214.4 °F 3: S -50 to +1768 °C -58.0 to +3214.4 °F 4: B 0 to 1800 °C 32.0 to 3272.0 °F 5: E -200 to +1000 °C -328.0 to +1832.0 °F 6: N 0 to 1300 °C 32.0 to 2372.0 °F 7: T -200 to +400 °C -328.0 to +752.0 °F 8: W5Re/W26Re 0 to 2300 °C 32.0 to 4172.0 °F 9: PLII 0 to 1390 °C 32.0 to 2534.0 °F RTD input (3-wire system) 12: Pt100 -200 to +850 °C -328.0 to +1562.0 °F 13: JPt100 -200 to +600 °C -328.0 to +1112.0 °F Voltage (V)/Current (I) inputs -19999 to +99999 14: 0 to 20 mA DC 15: 4 to 20 mA DC 16: 0 to 10 V DC 17: 0 to 5 V DC 18: 1 to 5 V DC 19: 0 to 1 V DC 20: 0 to 100 mV DC 21: 0 to 10 mV DC RTD input (4-wire system) 22: Pt100 -200 to +850 °C -328.0 to +1562.0 °F 23: JPt100 -200 to +600 °C -328.0 to +1112.0 °F	Based on model code. When not specifying: Type K	P. 87

Continued on the next page.

Continued from the previous page.

Function number	Name	Attribute	Data range	Factory set value	Reference page
6C	Input 1_ display unit selection	R/W	0: °C 1: °F	0	P. 88
6D	Input 1_ decimal point position	R/W	0: No decimal place 1: One decimal place 2: Two decimal places 3: Three decimal places 4: Four decimal places	1	P. 88
6E	Input 1_input scale high	R/W	TC/RTD inputs: Input scale low to Maximum value of the selected input range Voltage (V)/Current (I) inputs: -19999 to +99999 (Varies with the setting of the decimal point position)	TC/RTD: Maximum value of the selected input range V/I: 100.0	P. 89
6F	Input 1_input scale low	R/W	TC/RTD inputs: Minimum value of the selected input range to Input scale high Voltage (V)/Current (I) inputs: -19999 to +99999 (Varies with the setting of the decimal point position)	TC/RTD: Minimum value of the selected input range V/I: 0.0	P. 90
70	Input 1_input error determination point (high)	R/W	Input scale low – (5 % of input span) to Input scale high + (5 % of input span)	TC/RTD: Input scale high + (5 % of input span) V/I: 105.0	P. 91
71	Input 1_input error determination point (low)	R/W		TC/RTD: Input scale low – (5 % of input span) V/I: -5.0	P. 92
72	Input 1_burnout direction	R/W	0: Upscale 1: Downscale	0	P. 92
73	Input 1_square root extraction selection	R/W	0: Unused 1: Used	0	P. 93
74	Power supply frequency selection	R/W	0: 50 Hz 1: 60 Hz	0	P. 93

Continued on the next page.

Continued from the previous page.

Function number	Name	Attribute	Data range	Factory set value	Reference page
75	Input 2_input type selection	R/W	TC input 0: K -200 to +1372 °C -328.0 to +2501.6 °F 1: J -200 to +1200 °C -328.0 to +2192.0 °F 2: R -50 to +1768 °C -58.0 to +3214.4 °F 3: S -50 to +1768 °C -58.0 to +3214.4 °F 4: B 0 to 1800 °C 32.0 to 3272.0 °F 5: E -200 to +1000 °C -328.0 to +1832.0 °F 6: N 0 to 1300 °C 32.0 to 2372.0 °F 7: T -200 to +400 °C -328.0 to +752.0 °F 8: W5Re/W26Re 0 to 2300 °C 32.0 to 4172.0 °F 9: PLII 0 to 1390 °C 32.0 to 2534.0 °F RTD input (3-wire system) 12: Pt100 -200 to +850 °C -328.0 to +1562.0 °F 13: JPt100 -200 to +600 °C -328.0 to +1112.0 °F Voltage (V)/Current (I) inputs -19999 to +99999 14: 0 to 20 mA DC 15: 4 to 20 mA DC 16: 0 to 10 V DC 17: 0 to 5 V DC 18: 1 to 5 V DC 19: 0 to 1 V DC 20: 0 to 100 mV DC 21: 0 to 10 mV DC	Based on model code. When not specifying: Type K	P. 87
76	Input 2_ display unit selection	R/W	0: °C 1: °F	0	P. 88

Continued on the next page.

Continued from the previous page.

Function number	Name	Attribute	Data range	Factory set value	Reference page
77	Input 2_ decimal point position	R/W	0: No decimal place 1: One decimal place 2: Two decimal places 3: Three decimal places 4: Four decimal places	1	P. 88
78	Input 2_input scale high	R/W	TC/RTD inputs: Input scale low to Maximum value of the selected input range Voltage (V)/Current (I) inputs: -19999 to +99999 (Varies with the setting of the decimal point position)	TC/RTD: Maximum value of the selected input range V/I: 100.0	P. 89
79	Input 2_input scale low	R/W	TC/RTD inputs: Minimum value of the selected input range to Input scale high Voltage (V)/Current (I) inputs: -19999 to +99999 (Varies with the setting of the decimal point position)	TC/RTD: Minimum value of the selected input range V/I: 0.0	P. 90
7A	Input 2_input error determination point (high)	R/W	Input scale low – (5 % of input span) to Input scale high + (5 % of input span)	TC/RTD: Input scale high + (5 % of input span) V/I: 105.0	P. 91
7B	Input 2_input error determination point (low)	R/W		TC/RTD: Input scale low – (5 % of input span) V/I: -5.0	P. 92
7C	Input 2_ burnout direction	R/W	0: Upscale 1: Downscale	0	P. 92
7D	Input 2_square root extraction selection	R/W	0: Unused 1: Used	0	P. 93
7E	Event input logic selection	R/W	0 to 6	1	P. 94
7F	Output logic selection	R/W	1 to 11	1-input controller: 1 2-input controller: 5	P. 97
80	Output 1 timer setting	R/W	0.0 to 600.0 seconds	0.0	P. 99
81	Output 2 timer setting	R/W		0.0	P. 99
82	Output 3 timer setting	R/W		0.0	P. 99
83	Output 4 timer setting	R/W		0.0	P. 99
84	Output 5 timer setting	R/W		0.0	P. 99

Continued on the next page.

Continued from the previous page.

Function number	Name	Attribute	Data range	Factory set value	Reference page
85	Transmission output 1_ type selection	R/W	0: None 1: Input 1_measured value (PV) 2: Input 1_set value (SV) 3: Input 1_deviation value 4: Input 1_manipulated output value (MV) 5: Input 2_measured value (PV) 6: Input 2_set value (SV) 7: Input 2_deviation value 8: Input 2_manipulated output value (MV) 9: Feedback resistance input value (POS)	0	P. 101
86	Transmission output 1_ scale high	R/W	Measured value (PV) and Set value (SV): Input scale low to Input scale high Manipulated output value (MV) and Feedback resistance input value (POS): -5.0 to +105.0 %	PV/SV: Input scale high MV/POS: 100.0 Deviation: +Input span	P. 102
87	Transmission output 1_ scale low	R/W	Deviation: -Input span to +Input span	PV/SV: Input scale low MV/POS: 0.0 Deviation: -Input span	P. 103
88	Transmission output 2_ type selection	R/W	0: None 1: Input 1_measured value (PV) 2: Input 1_set value (SV) 3: Input 1_deviation value 4: Input 1_manipulated output value (MV) 5: Input 2_measured value (PV) 6: Input 2_set value (SV) 7: Input 2_deviation value 8: Input 2_manipulated output value (MV) 9: Feedback resistance input value (POS)	0	P. 101

Continued on the next page.

Continued from the previous page.

Function number	Name	Attribute	Data range	Factory set value	Reference page
89	Transmission output 2_ scale high	R/W	Measured value (PV) and Set value (SV): Input scale low to Input scale high Manipulated output value (MV) and Feedback resistance input value (POS): -5.0 to +105.0 %	PV/SV: Input scale high MV/POS: 100.0 Deviation: +Input span	P. 102
8A	Transmission output 2_ scale low	R/W	Deviation: -Input span to +Input span	PV/SV: Input scale low MV/POS: 0.0 Deviation: -Input span	P. 103
8B	Transmission output 3_ type selection	R/W	0: None 1: Input 1_measured value (PV) 2: Input 1_set value (SV) 3: Input 1_deviation value 4: Input 1_manipulated output value (MV) 5: Input 2_measured value (PV) 6: Input 2_set value (SV) 7: Input 2_deviation value 8: Input 2_manipulated output value (MV) 9: Feedback resistance input value (POS)	0	P. 101
8C	Transmission output 3_ scale high	R/W	Measured value (PV) and Set value (SV): Input scale low to Input scale high Manipulated output value (MV) and Feedback resistance input value (POS): -5.0 to +105.0 %	PV/SV: Input scale high MV/POS: 100.0 Deviation: +Input span	P. 102
8D	Transmission output 3_ scale low	R/W	Deviation: -Input span to +Input span	PV/SV: Input scale low MV/POS: 0.0 Deviation: -Input span	P. 103
8E	Event 1 type selection	R/W	0: None 1: Deviation high 2: Deviation low 3: Deviation high/low 4: Band 5: Process high 6: Process low 7: SV high 8: SV low	0	P. 104

Continued on the next page.

Continued from the previous page.

Function number	Name	Attribute	Data range	Factory set value	Reference page
8F	Event 1 hold action	R/W	0: OFF 1: ON 2: Re-hold action ON	0	P. 106
90	Event 1 differential gap	R/W	0 to Input span (Varies with the setting of the Decimal point position)	TC/RTD: 2.0 °C [°F] V/I: 0.2 % of input span	P. 108
91	Event 1 action at input error	R/W	0: Normal processing 1: Turn the event output ON	0	P. 110
92	Event 1 assignment	R/W	1: For input 1 2: For input 2	1	P. 111
93	Event 2 type selection	R/W	0: None 1: Deviation high 2: Deviation low 3: Deviation high/low 4: Band 5: Process high 6: Process low 7: SV high 8: SV low	0	P. 103
94	Event 2 hold action	R/W	0: OFF 1: ON 2: Re-hold action ON	0	P. 106
95	Event 2 differential gap	R/W	0 to Input span (Varies with the setting of the Decimal point position)	TC/RTD: 2.0 °C [°F] V/I: 0.2 % of input span	P. 108
96	Event 2 action at input error	R/W	0: Normal processing 1: Turn the event output ON	0	P. 110
97	Event 2 assignment	R/W	1: For input 1 2: For input 2	1	P. 111
98	Event 3 type selection	R/W	0: None 1: Deviation high 2: Deviation low 3: Deviation high/low 4: Band 5: Process high 6: Process low 7: SV high 8: SV low 9: Control loop break alarm (LBA)	0	P. 103
99	Event 3 hold action	R/W	0: OFF 1: ON 2: Re-hold action ON	0	P. 106

Continued on the next page.

Continued from the previous page.

Function number	Name	Attribute	Data range	Factory set value	Reference page
9A	Event 3 differential gap	R/W	0 to Input span (Varies with the setting of the Decimal point position)	TC/RTD: 2.0 °C [°F] V/I: 0.2 % of input span	P. 108
9B	Event 3 action at input error	R/W	0: Normal processing 1: Turn the event output ON	0	P. 110
9C	Event 3 assignment	R/W	1: For input 1 2: For input 2	1	P. 111
9D	Event 4 type selection	R/W	0: None 1: Deviation high 2: Deviation low 3: Deviation high/low 4: Band 5: Process high 6: Process low 7: SV high 8: SV low 9: Control loop break alarm (LBA)	0	P. 103
9E	Event 4 hold action	R/W	0: OFF 1: ON 2: Re-hold action ON	0	P. 106
9F	Event 4 differential gap	R/W	0 to Input span (Varies with the setting of the Decimal point position)	TC/RTD: 2.0 °C [°F] V/I: 0.2 % of input span	P. 108
A0	Event 4 action at input error	R/W	0: Normal processing 1: Turn the event output ON	0	P. 110
A1	Event 4 assignment	R/W	1: For input 1 2: For input 2	1	P. 111
A2	CT1 ratio	R/W	0 to 9999	Based on model code.	P. 112
A3	CT1 assignment	R/W	0: None 3: OUT3 1: OUT1 4: OUT4 2: OUT2 5: OUT5	CT1 provided: 1 (When HBA1 is specified) CT1 not provided: 0	P. 113
A4	CT2 ratio	R/W	0 to 9999	Depend on model code.	P. 112
A5	CT2 assignment	R/W	0: None 3: OUT3 1: OUT1 4: OUT4 2: OUT2 5: OUT5	CT2 provided: 2 (When HBA2 is specified) CT2 not provided: 0	P. 113

Continued on the next page.

Continued from the previous page.

Function number	Name	Attribute	Data range	Factory set value	Reference page
A6	Hot/Cold start selection	R/W	Power failure less than 3 seconds: 0: Hot 1 5: Cold 1: Hot 1 6: Hot 1 2: Hot 1 7: Hot 2 3: Hot 2 8: Stop 4: Hot 2 Power failure 3 seconds or more: 0: Hot 1 5: Cold 1: Hot 2 6: Stop 2: Cold 7: Stop 3: Hot 2 8: Stop 4: Cold	0	P. 114
A7	Input 2_use selection	R/W	0: Single loop control 1: Remote input 2: Cascade control (slave)	0	P. 115
A8	Cascade ratio	R/W	0.0000 to 1.5000	1.0000	P. 115
A9	Cascade bias	R/W	-Input span to +Input span	0.0	P. 115
AA	SV tracking	R/W	0: Unused 1: Used	1	P. 117
AB	Input 1_control action type selection	R/W	0: Direct action 1: Reverse action	1	P. 118
AC	Input 1_integral/derivative time decimal point position selection	R/W	0: No decimal place 1: One decimal place 2: Two decimal places	2	P. 119
AD	Input 1_derivative gain	R/W	0.1 to 10.0	6.0	P. 119
AE	Input 1_ON/OFF action differential gap (upper)	R/W	0 to Input span (Varies with the setting of the Decimal point position)	TC/RTD: 1.0 °C [°F] V/I: 0.1 % of input span	P. 120
AF	Input 1_ON/OFF action differential gap (lower)	R/W		TC/RTD: 1.0 °C [°F] V/I: 0.1 % of input span	P. 121
B0	Input 1_action at input error (high)	R/W	0: Normal control 1: Manipulated output value at input error	0	P. 122
B1	Input 1_action at input error (low)	R/W		0	P. 123
B2	Input 1_manipulated output value at input error	R/W	-5.0 to +105.0 %	-5.0	P. 123
B3	Input 1_output change rate limiter (up)	R/W	0.0 to 1000.0 %/second of manipulated output	0.0	P. 124
B4	Input 1_output change rate limiter (down)	R/W	0.0: OFF (Unused)	0.0	P. 124

Continued on the next page.

Continued from the previous page.

Function number	Name	Attribute	Data range	Factory set value	Reference page
B5	Input 1_output limiter high	R/W	Input 1_output limiter low to 105.0 %	105.0	P. 126
B6	Input 1_output limiter low	R/W	-5.0 % to Input 1_output limiter high	-5.0	P. 126
B7	Input 1_power feed forward selection	R/W	0: Unused 1: Used	Based on model code.	P. 127
B8	Input 2_control action type selection	R/W	0: Direct action 1: Reverse action	1	P. 118
B9	Input 2_integral/derivative time decimal point position selection	R/W	0: No decimal place 1: One decimal place 2: Two decimal places	2	P. 119
BA	Input 2_derivative gain	R/W	0.1 to 10.0	6.0	P. 119
BB	Input 2_ON/OFF action differential gap (upper)	R/W	0 to Input span (Varies with the setting of the Decimal point position)	TC/RTD: 1.0 °C [°F] V/I: 0.1 % of input span	P. 120
BC	Input 2_ON/OFF action differential gap (lower)	R/W		TC/RTD: 1.0 °C [°F] V/I: 0.1 % of input span	P. 121
BD	Input 2_action at input error (high)	R/W	0: Normal control 1: Manipulated output value at input error	0	P. 122
BE	Input 2_action at input error (low)	R/W		0	P. 123
BF	Input 2_manipulated output value at input error	R/W	-5.0 to +105.0 %	-5.0	P. 123
C0	Input 2_output change rate limiter (up)	R/W	0.0 to 1000.0 %/second of manipulated output 0.0: OFF (Unused)	0.0	P. 124
C1	Input 2_output change rate limiter (down)	R/W		0.0	P. 124
C2	Input 2_output limiter high	R/W	Input 2_output limiter low to 105.0 %	105.0	P. 126
C3	Input 2_output limiter low	R/W	-5.0 % to Input 2_output limiter high	-5.0	P. 126
C4	Input 2_power feed forward selection	R/W	0: Unused 1: Used	Based on model code.	P. 127
C5	Input 1_AT bias	R/W	-Input span to +Input span	0	P. 129
C6	Input 1_AT cycle	R/W	0: 1.5 cycles 2: 2.5 cycles 1: 2.0 cycles 3: 3.0 cycles	1	P. 130

Continued on the next page.

Continued from the previous page.

Function number	Name	Attribute	Data range	Factory set value	Reference page
C7	Input 1_ AT differential gap time	R/W	0.00 to 50.00 seconds	HA400/900: 0.10 HA401/901: 10.00	P. 131
C8	Input 2_AT bias	R/W	-Input span to +Input span	0	P. 129
C9	Input 2_AT cycle	R/W	0: 1.5 cycles 2: 2.5 cycles 1: 2.0 cycles 3: 3.0 cycles	1	P. 130
CA	Input 2_ AT differential gap time	R/W	0.00 to 50.00 seconds	HA400/900: 0.10 HA401/901: 10.00	P. 131
CB	Open/Close output neutral zone	R/W	0.1 to 10.0 % of output	10.0	P. 133
CC	Open/Close output differential gap	R/W	0.1 to 5.0 % of output	0.2	P. 134
CD	Action at feedback resistance (FBR) input error	R/W	0: Close-side output ON, Open-side output OFF 1: Close-side output OFF, Open-side output OFF 2: Close-side output OFF, Open-side output ON	0	P. 134
CE	Feedback adjustment	R/W	0: Adjustment end 1: During the Open-side adjusting 2: During the Close-side adjusting	—	P. 135
CF	Setting change rate limiter unit time	R/W	1 to 3600 seconds	60	P. 136
D0	Soak time unit selection	R/W	0: 0 hour 00 minutes 00 seconds to 9 hours 59 minutes 59 seconds 2: 0 minutes 00.00 seconds to 9 minutes 59.99 seconds	2	P. 136
D1	Input 1_setting limiter high	R/W	Input 1_setting limiter low to Input 1_input scale high	Input 1_ input scale high	P. 137
D2	Input 1_setting limiter low	R/W	Input 1_input scale low to Input 1_setting limiter high	Input 1_ input scale low	P. 138
D3	Input 2_setting limiter high	R/W	Input 2_setting limiter low to Input 2_input scale high	Input 2_ input scale high	P. 137
D4	Input 2_setting limiter low	R/W	Input 2_input scale low to Input 2_setting limiter high	Input 2_ input scale low	P. 138
D5	ROM version display	RO	Displays the version of loaded software.	—	P. 138
D6	Integrated operating time display	RO	0 to 99999 hours	—	P. 139
D7	Holding peak value ambient temperature display	RO	-10.0 to +100.0 °C	—	P. 139

Continued on the next page.

Continued from the previous page.

Function number	Name	Attribute	Data range	Factory set value	Reference page
D8	Power feed transformer input value display	RO	0.0 to 160.0 % (Displays in the percentage of the rated value)	—	P. 139
D9	Feedback resistance (FBR) input assignment	R/W	1: Input 1 2: Input 2	1	P. 140
DA	Input 1_ power feed forward gain	R/W	0.01 to 5.00	1.00	P. 140
DB	Input 2_ power feed forward gain	R/W		1.00	P. 140
DC	Heater break alarm 1 (HBA1) type selection	R/W	0: Heater break alarm (HBA) type A 1: Heater break alarm (HBA) type B	1	P. 141
DD	Number of heater break alarm 1 (HBA1) delay times	R/W	0 to 255	5	P. 142
DE	Heater break alarm 2 (HBA2) type selection	R/W	0: Heater break alarm (HBA) type A 1: Heater break alarm (HBA) type B	1	P. 141
DF	Number of heater break alarm 2 (HBA2) delay times	R/W	0 to 255	5	P. 142
E0	Alarm lamp lighting condition setting 1	R/W	Bit data Bit 0: Event 1 Bit 1: Event 2 Bit 2: Event 3 Bit 3: Event 4 Bit 4 to Bit 31: Unused Data 0: ALM lamp is not lit 1: ALM lamp is lit [Decimal number: 0 to 15]	15	P. 143
E1	Alarm lamp lighting condition setting 2	R/W	Bit data Bit 0: HBA1 Bit 1: HBA2 Bit 2 to Bit 31: Unused Data 0: ALM lamp is not lit 1: ALM lamp is lit [Decimal number: 0 to 3]	3	P. 144
E2 • • • FF	Unused	—	—	—	—

6. COMMUNICATION DATA DESCRIPTION

■ Reference to communication data contents

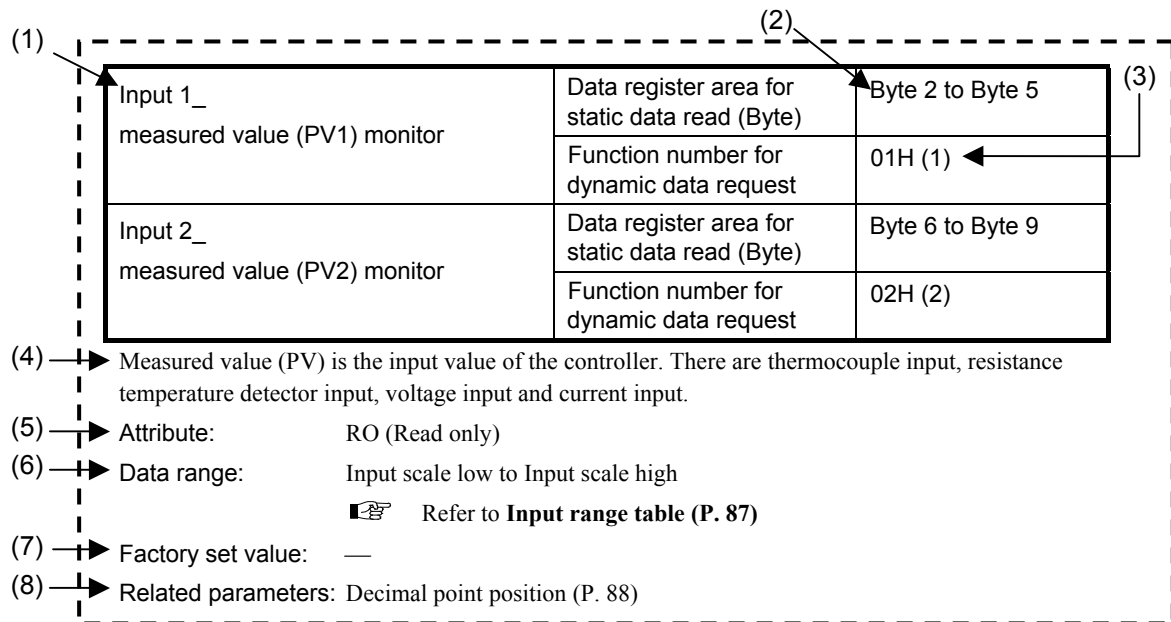

(1) Name: Communication data name is written.

(2) Data register area for static data read (Byte):
Data register area used for static data read is written.

(3) Function number for dynamic data request:
Function number specified at the time of dynamic data request is written.
Function number is written using both of hexadecimal and decimal (in parentheses) numbers.

(4) Description: A short description of the communication data item is written.

(5) Attribute: A method of how communication data items are read or written when viewed from the host computer is described.

RO: Only reading data is possible.

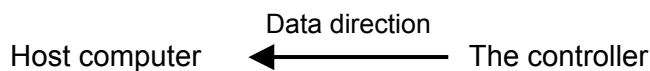

R/W: Reading and writing data is possible.

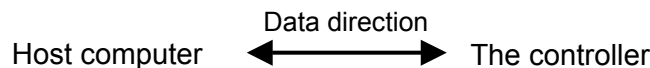

(6) Data range: The reading range or the writing range of communication data is written.

(7) Factory set value: The factory set value of communication data is written.

(8) Related parameters: A name and a page of related parameters are written.

There is item including the functional description.

Controller status information	Data register area for static data read (Byte)	Byte 0 to Byte 1
	Function number for dynamic data request	No assignment

This item is the status information on the controller.

Attribute: RO (Read only)

Data range: Only Bit 0 and Bit 1 in Byte 0 are used.

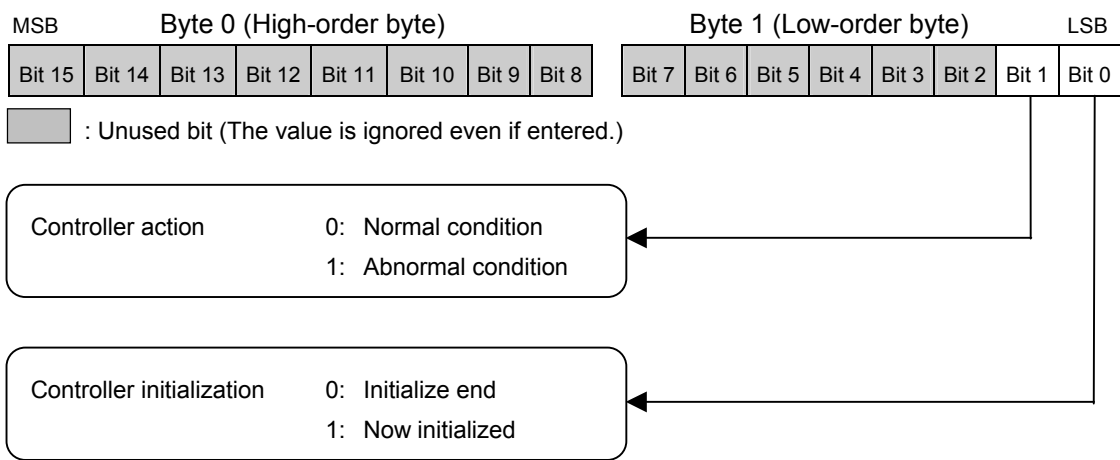

Until all data assigned to the input data area are updated after the controller is initialized, Bit 0 remains at 1.

Factory set value: —

Input 1_ measured value (PV1) monitor	Data register area for static data read (Byte)	Byte 2 to Byte 5
	Function number for dynamic data request	01H (1)
Input 2_ measured value (PV2) monitor	Data register area for static data read (Byte)	Byte 6 to Byte 9
	Function number for dynamic data request	02H (2)

Measured value (PV) is an input value of the controller. There are Thermocouple input (TC), Resistance temperature detector input (RTD), Voltage input (V) and Current input (I).

Attribute: RO (Read only)

Data range: Input scale low to Input scale high

 Refer to **Input range table (P. 87)**

Factory set value: —

Related parameters: Decimal point position (P. 88)

Feedback resistance input value monitor	Data register area for static data read (Byte)	Byte 10 to Byte 13
	Function number for dynamic data request	03H (3)

This value is a feedback resistance (FBR) input value of the controller.

Attribute: RO (Read only)

Data range: 0.0 to 100.0 %

Factory set value: —

Related parameters: Open/Close output neutral zone (P. 133),
Open/Close output differential gap (P. 134)

Current transformer input value 1 (CT1) monitor	Data register area for static data read (Byte)	Byte 14 to Byte 17
	Function number for dynamic data request	04H (4)
Current transformer input value 2 (CT2) monitor	Data register area for static data read (Byte)	Byte 18 to Byte 21
	Function number for dynamic data request	05H (5)

This value is a current transformer input value that is used for heater break alarm function.

Attribute: RO (Read only)

Data range: When the CT type is CTL-6-P-N: 0.0 to 30.0 A
When the CT type is CTL-12-S56-10L-N: 0.0 to 100.0 A



The CT input cannot measure less than 0.4 A.

Factory set value: —

Related parameters: Heater break alarm (HBA) state (P. 53),
Heater break alarm (HBA) set value (P. 73),
CT ratio (P. 112), CT assignment (P. 113)

Input 1_set value (SV1) monitor	Data register area for static data read (Byte)	Byte 22 to Byte 25
	Function number for dynamic data request	06H (6)
Input 2_set value (SV2) monitor	Data register area for static data read (Byte)	Byte 26 to Byte 29
	Function number for dynamic data request	07H (7)

This value is a monitor of the Set value (SV) that is a desired value for control.

Attribute: RO (Read only)

Data range: Setting limiter low to Setting limiter high
 Refer to **Input range table (P. 87)**

Factory set value: —

Related parameters: Decimal point position (P. 88)

Remote input value monitor	Data register area for static data read (Byte)	Byte 30 to Byte 33
	Function number for dynamic data request	08H (8)

This value is an input value that is used for remote input function.

Attribute: RO (Read only)

Data range: Input 1_setting limiter low to Input 1_setting limiter high
 Refer to **Input range table (P. 87)**

Factory set value: —

Cascade monitor	Data register area for static data read (Byte)	Byte 34 to Byte 37
	Function number for dynamic data request	09H (9)

This value is an input value (a commanding value from the master) that is used for cascade control function.

Attribute: RO (Read only)

Data range: Input 2_setting limiter low to Input 2_setting limiter high
 Refer to **Input range table (P. 87)**

Factory set value: —

Related parameters: Input 2_use selection (P. 115)

Input 1_burnout state	Data register area for static data read (Byte)	Byte 38 to Byte 41
	Function number for dynamic data request	0AH (10)
Input 2_burnout state	Data register area for static data read (Byte)	Byte 42 to Byte 45
	Function number for dynamic data request	0BH (11)

This value expresses a state in input break.

Attribute: RO (Read only)

Data range: Only Bit 0 in Byte 41 and Byte 45 are used.

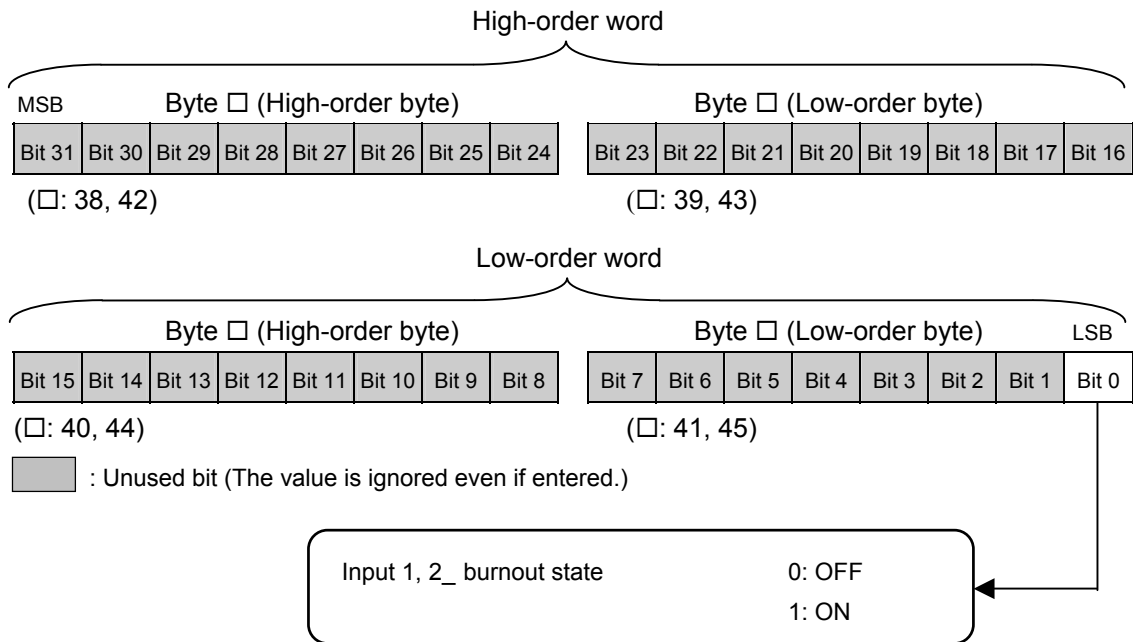

Factory set value: —

Related parameters: Burnout direction (P. 92)

Feedback resistance input burnout state	Data register area for static data read (Byte)	Byte 46 to Byte 49
	Function number for dynamic data request	0CH (12)

This value expresses a state in feedback resistance input break.

Attribute: RO (Read only)

Data range: Only Bit 0 in Byte 49 is used.

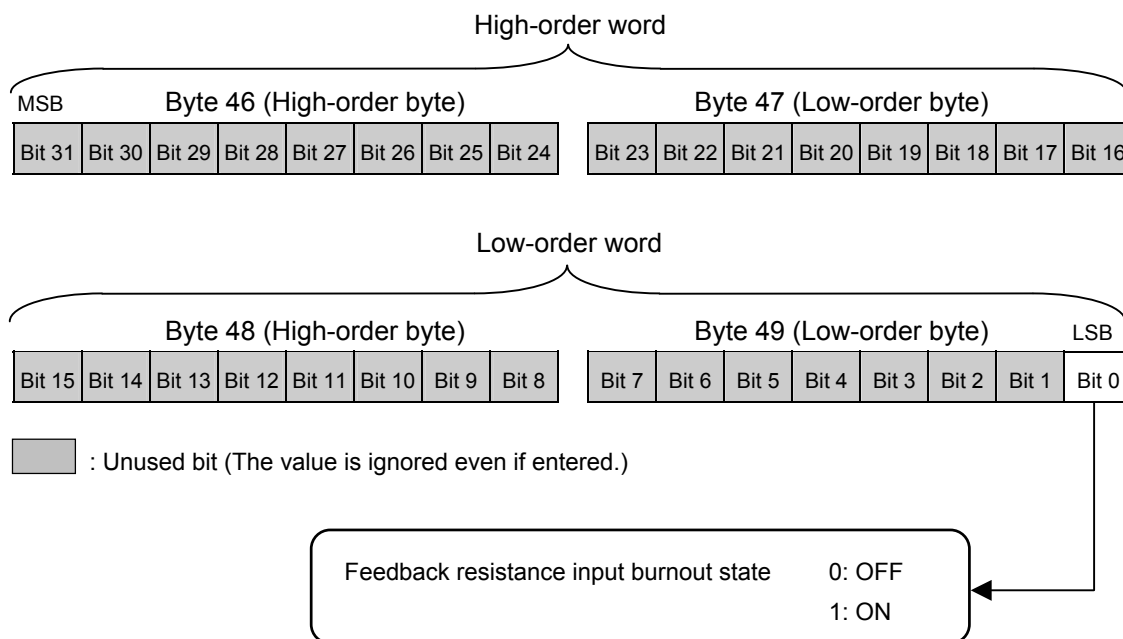

Factory set value: —

Related parameters: Action at feedback resistance (FBR) input error (P. 134)

Event 1 state	Data register area for static data read (Byte)	Byte 50 to Byte 53
	Function number for dynamic data request	0DH (13)
Event 2 state	Data register area for static data read (Byte)	Byte 54 to Byte 57
	Function number for dynamic data request	0EH (14)
Event 3 state	Data register area for static data read (Byte)	Byte 58 to Byte 61
	Function number for dynamic data request	0FH (15)
Event 4 state	Data register area for static data read (Byte)	Byte 62 to Byte 65
	Function number for dynamic data request	10H (16)

This value expresses a state of the event ON/OFF.

Attribute: RO (Read only)

Data range: Only Bit 0 in Byte 53, 57, 61 and 65 are used.

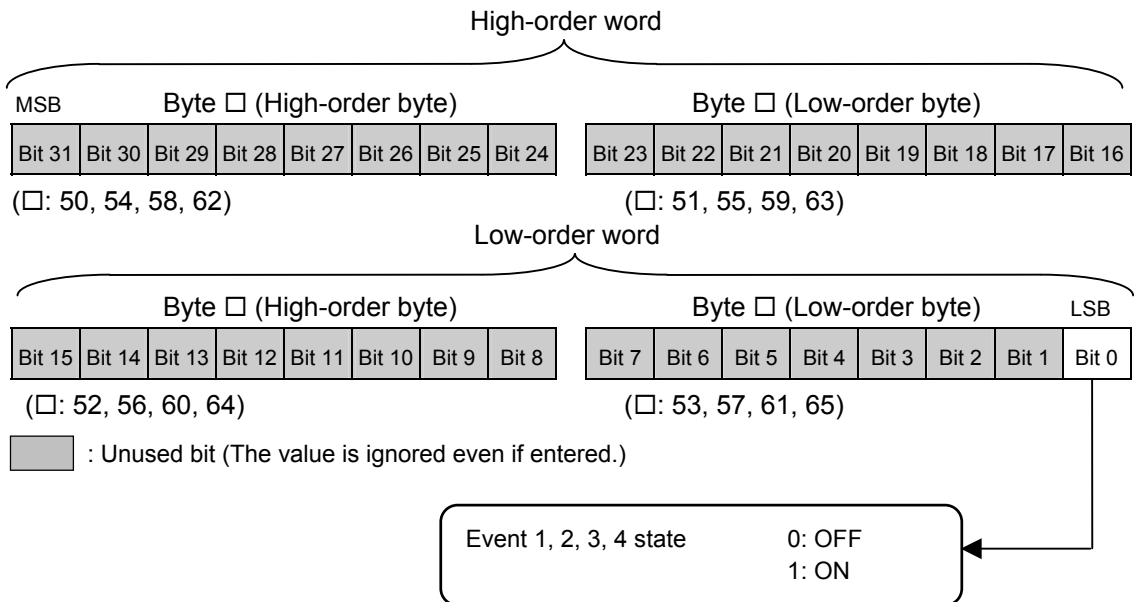

Factory set value: —

Related parameters: Event set value (P. 62), Output logic selection (P. 97),
 Event type selection (P. 104), Event hold action (P. 106),
 Event differential gap (P. 108), Event action at input error (P. 110),
 Event assignment (P. 111)

Input 1_ manipulated output value (MV1) monitor	Data register area for static data read (Byte)	Byte 74 to Byte 77
	Function number for dynamic data request	13H (19)
Input 2_ manipulated output value (MV2) monitor	Data register area for static data read (Byte)	Byte 78 to Byte 81
	Function number for dynamic data request	14H (20)

This value is an output value of the controller.

Attribute: RO (Read only)

Data range: -5.0 to +105.0 %

Factory set value: —

Related parameters: Manual output value (P. 78), Output logic selection (P. 97),
Output change rate limiter (up/down) (P. 124),
Output limiter high/low (P. 126)

Error code	Data register area for static data read (Byte)	Byte 82 to Byte 85
	Function number for dynamic data request	15H (21)

Each error state of the controller is expressed in bit data items.

Attribute: RO (Read only)

Data range: 0 to 4095 (Bit data)

Bit 0 to Bit 5, Bit 7 and Bit 11 are used.

(Bit 6, Bit 8 to Bit 10, Bit 12 to Bit 31: Unused)

Each error state is assigned as a bit image in binary numbers.

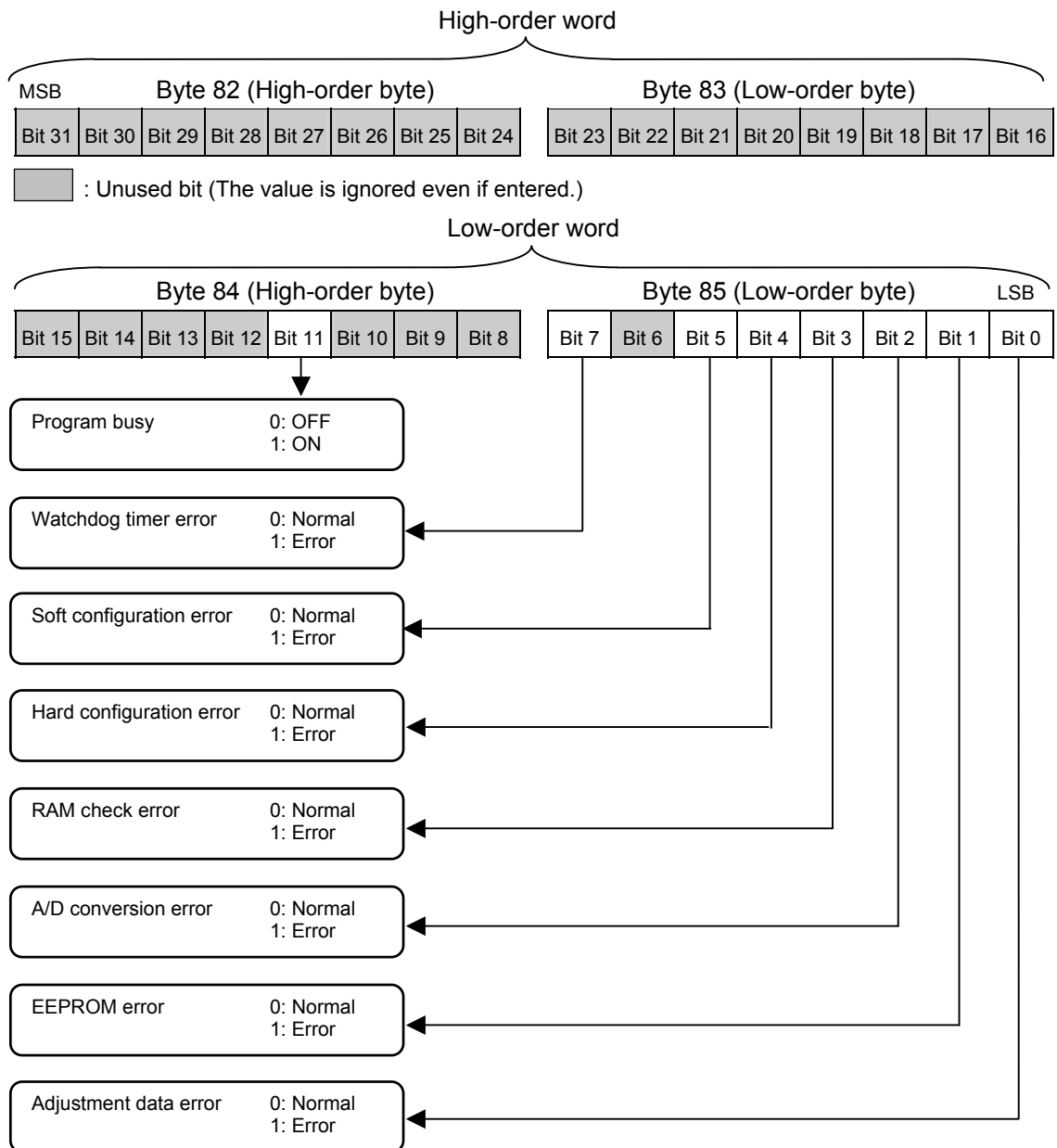

Factory set value: —

Event input (DI) state	Data register area for static data read (Byte)	Byte 86 to Byte 89
	Function number for dynamic data request	16H (22)

Each event input state of the controller is expressed in bit data items.

Attribute: RO (Read only)

Data range: 0 to 127 (Bit data)

Bit 0 to Bit 6 are used. (Bit 7 to Bit 31: Unused)

Error event input (DI) state is assigned as a bit image in binary numbers.

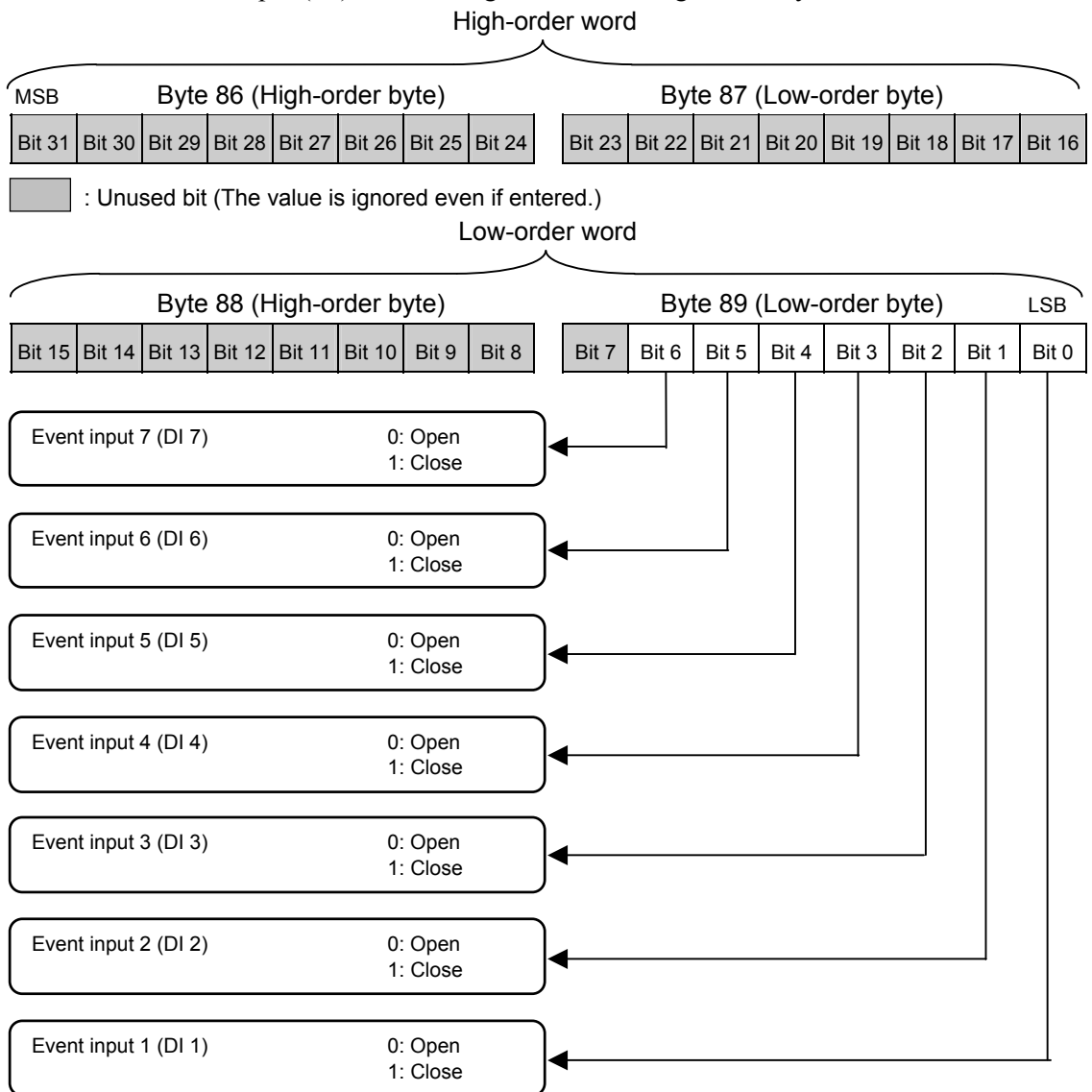

Factory set value: —

Related parameters: Event input logic selection (P. 94)

Operation mode state	Data register area for static data read (Byte)	Byte 90 to Byte 93
	Function number for dynamic data request	17H (23)

Each operation mode state of the controller is expressed in bit data items.

Attribute: RO (Read only)

Data range: 0 to 31 (Bit data)

Bit 0 to Bit 4 are used. (Bit 5 to Bit 31: Unused)

Each operation mode state is assigned as a bit image in binary numbers.

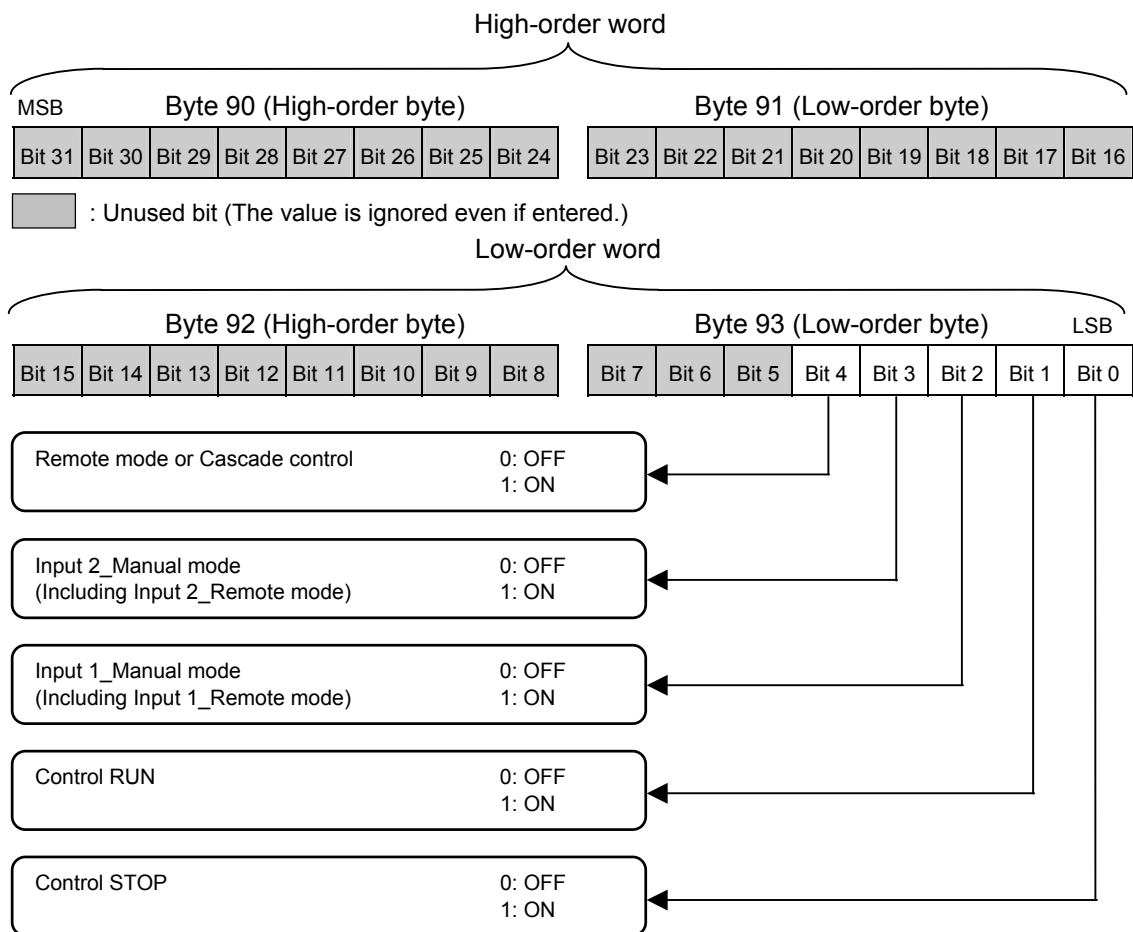

Factory set value: —

Related parameters: Auto/Manual transfer (P. 60), Remote/Local transfer (P. 60),
RUN/STOP transfer (P. 61), Input 2_use selection (P. 115)

Memory area soak time monitor	Data register area for static data read (Byte)	Byte 94 to Byte 97
	Function number for dynamic data request	18H (24)

Monitors the time elapsed for memory area operation (soak time) when Ramp/Soak control by using multi-memory area is performed.

Attribute: RO (Read only)

Data range: 0 minute 00.00 second to 9 minutes 59.99 seconds or
0 hour 00 minute 00 second to 9 hours 59 minutes 59 seconds

 Memory area soak time monitor is expressed in second unit for PROFIBUS communication.

0 minute 00.00 second to 9 minutes 59.99 seconds: 0 to 59999 seconds

0 hour 00 minute 00 second to 9 hours 59 minutes 59 seconds:
0 to 35999 seconds

Factory set value: —

Related parameters: Area soak time (P. 71), Soak time unit selection (P. 136)

 As the area soak time for the memory area linked last becomes invalidated, no area soak time is monitored.

Input 1_PID/AT transfer	Data register area for static data read (Byte)	No assignment
	Function number for dynamic data request	19H (25)
Input 2_PID/AT transfer	Data register area for static data read (Byte)	No assignment
	Function number for dynamic data request	1AH (26)

This item transfers PID control and Autotuning (AT).

Attribute: R/W (Read and Write)

 **Input 2_PID/AT transfer becomes RO (Read only) for 1-input controller.**

Data range: 0: PID control
1: Autotuning (AT)

Factory set value: Input 1_PID/AT transfer: 0
Input 2_PID/AT transfer: 0

Related parameters: AT bias (P. 129), AT cycle (P. 130), AT differential gap time (P. 131)

Continued on the next page.

Continued from the previous page.

Autotuning (AT):

Autotuning (AT) function automatically measures, calculates and sets the optimum PID constants. The followings are the conditions necessary to carry out autotuning and the conditions which will cause the autotuning to stop.

Requirements for AT start:

Start the autotuning when all following conditions are satisfied:

- Operation mode conditions are as follows:
 - Auto/Manual transfer → Auto mode
 - Remote/Local transfer → Local mode
 - PID/AT transfer → PID control
 - RUN/STOP transfer → Control RUN
- The Measured value (PV) is without input error range [Input error determination point (high) > Measured value (PV) > Input error determination point (low)].
- The output limiter high is 0.1 % or higher and the output limiter low is 99.9 % or less.



When the autotuning is finished, the controller will automatically returns to PID control.



When the cascade control is activated, the AT function can not be turned on.

Requirement for AT cancellation:

The autotuning is canceled if any of the following conditions exist.

- When the temperature set value (SV) is changed.
- When the output limiter high or the output limiter low is changed.
- When the PV bias, the PV digital filter, or the PV ratio is changed.
- When the Auto/Manual mode is changed to the Manual mode.
- When the Remote/Local mode is changed to the Remote mode.
- When the Measured value (PV) goes to input error range [Measured value (PV) \geq Input error determination point (high) or Input error determination point (low) \geq Measured value (PV)].
- When the power failure occurs.
- When the instrument is in the FAIL state.
- When the PID/AT transfer is changed to the PID control.
- When the RUN/STOP mode is changed to the control STOP.



**If the AT is canceled, the controller immediately changes to PID control.
The PID values will be the same as before AT was activated.**

Input 1_Auto/Manual transfer	Data register area for static data read (Byte)	No assignment
	Function number for dynamic data request	1BH (27)
Input 2_Auto/Manual transfer	Data register area for static data read (Byte)	No assignment
	Function number for dynamic data request	1CH (28)

This item transfers the Automatic (AUTO) control and the Manual (MAN) control.

Attribute: R/W (Read and Write)



The Input 2_Auto/Manual transfer becomes RO (Read only) for the 1-input controller.

Data range: 0: Auto mode
1: Manual mode

Factory set value: Input 1_Auto/Manual transfer: 0
Input 2_Auto/Manual transfer: 0

Related parameters: Operation mode state (P. 57)

Remote/Local transfer	Data register area for static data read (Byte)	No assignment
	Function number for dynamic data request	1DH (29)

This item selects to use the set value of local or remote input.

Attribute: R/W (Read and Write)



This item becomes RO (Read only) besides the remote input specification or the cascade control specification.

Data range: 0: Local mode
1: Remote mode or Cascade control (Slave)

Factory set value: 0

Related parameters: Operation mode state (P. 57)

RUN/STOP transfer	Data register area for static data read (Byte)	No assignment
	Function number for dynamic data request	1EH (30)

This item transfers Control RUN and Control STOP.

Attribute: R/W (Read and Write)

Data range: 0: Control RUN
1: Control STOP

Factory set value: 0

Related parameters: Operation mode state (P. 57)



The controller status at STOP mode is the same as that of Power-off. However for the specification with current output (other than 0 to 20 mA) or voltage output, an output of -5 % is fed when at STOP.



If the instrument is transferred to RUN mode from STOP mode, it performs the same operation (control RUN, Event determination start-up) as the power-on.

Memory area selection	Data register area for static data read (Byte)	No assignment
	Function number for dynamic data request	1FH (31)

Selects the memory area (control area) used for control.

Attribute: R/W (Read and Write)

Data range: 1 to 16

Factory set value: 1

Event 1 set value	Data register area for static data read (Byte)	No assignment
	Function number for dynamic data request	20H (32)
Event 2 set value	Data register area for static data read (Byte)	No assignment
	Function number for dynamic data request	21H (33)
Event 3 set value	Data register area for static data read (Byte)	No assignment
	Function number for dynamic data request	22H (34)
Event 4 set value	Data register area for static data read (Byte)	No assignment
	Function number for dynamic data request	25H (37)

Event 1 through Event 4 are set values of the event action.

Attribute: R/W (Read and Write)



The Event 3 set value becomes RO (Read only) when it was selected “9: Control loop break alarm (LBA)” from the Event 3 type selection.



The Event 4 set value becomes RO (Read only) when it was selected “9: Control loop break alarm (LBA)” from the Event 3 type selection.

Data range: Deviation: –Input span to +Input span
 Process: Input scale low to Input scale high
 SV: Input scale low to Input scale high

Factory set value: 50.0

Related parameters: Event state (P. 52), Event type selection (P. 104), Event hold action (P. 106),
 Event differential gap (P. 108), Event action at input error (P. 110),
 Event assignment (P. 111)

Control loop break alarm 1 (LBA1) time	Data register area for static data read (Byte)	No assignment
	Function number for dynamic data request	23H (35)
Control loop break alarm 2 (LBA2) time	Data register area for static data read (Byte)	No assignment
	Function number for dynamic data request	26H (38)

The LBA time sets the time required for the LBA function to determine there is a loop failure. When the LBA is output (under alarm status), the LBA function still monitors the Measured value (PV) variation at an interval of the LBA time.

Attribute: R/W (Read and Write)



The control loop break alarm 1 (LBA1) time becomes RO (Read only) when it was selected “1 to 8” from the Event 3 type selection.



The control loop break alarm 2 (LBA2) time becomes RO (Read only) when it was selected “1 to 8” from the Event 4 type selection.

Data range: 0 to 7200 seconds (0: Unused)

Factory set value: 480

Related parameters: Event state (P. 52), LBA deadband (P. 63), Event assignment (P. 111)

LBA1 deadband	Data register area for static data read (Byte)	No assignment
	Function number for dynamic data request	24H (36)
LBA2 deadband	Data register area for static data read (Byte)	No assignment
	Function number for dynamic data request	27H (39)

The LBA deadband gives a neutral zone to prevent the control loop break alarm (LBA) from malfunctioning caused by disturbance.

Attribute: R/W (Read and Write)



The LBA1 deadband becomes RO (Read only) when it was selected “1 to 8” from the Event 3 type selection.



The LBA2 deadband becomes RO (Read only) when it was selected “1 to 8” from the Event 4 type selection.

Data range: 0.0 to Input span
(Varies with the setting of the Decimal point position)

Factory set value: 0.0

Related parameters: Event state (P. 52), Control loop break alarm (LBA) time (P. 63), Event assignment (P. 111)

■ LBA Function

Control loop break alarm (LBA):

The control loop break alarm (LBA) function is used to detect a load (heater) break or a failure in the external actuator (power controller, magnet relay, etc.), or a failure in the control loop caused by an input (sensor) break. The LBA function is activated when control output reaches 0 % (low limit with output limit function) or 100 % (high limit with output limit function). LBA monitors variation of the Measured value (PV) for the length of LBA time. When the LBA time has elapsed and the PV is still within the alarm determination range, the LBA will be ON.

[Alarm action]

LBA determination range: Temperature input: 2 °C [2 °F] (fixed)
Voltage/Current input: 0.2 % of span (fixed)

• When the output reaches 0 % (low limit with output limit function)

For direct action: When the LBA time has passed and the PV has not risen beyond the alarm determination range, the alarm will be turned on.

For reverse action: When the LBA time has passed and the PV has not fallen below the alarm determination range, the alarm will be turned on.

• When the output exceeds 100 % (high limit with output limit function)

For direct action: When the LBA time has passed and the PV has not fallen below the alarm determination range, the alarm will be turned on.

For reverse action: When the LBA time has passed and the PV has not risen beyond the alarm determination range, the alarm will be turned on.



If the autotuning function is used, the LBA time is automatically set twice as large as the integral time. The LBA setting time will not be changed even if the integral time is changed.

LBA Deadband function:

The LBA may malfunction due to external disturbances. To prevent malfunctioning due to external disturbance, LBA deadband (LBD) sets a neutral zone in which LBA is not activated. When the Measured value (PV) is within the LBD area, LBA will not be activated. If the LBD setting is not correct, the LBA will not work correctly.

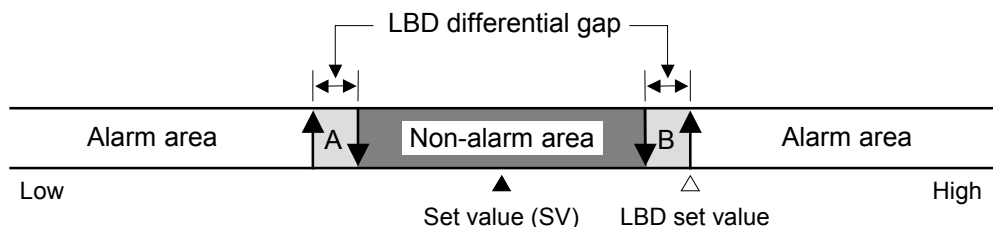





- A: During temperature rise: Alarm area
During temperature fall: Non-alarm area
- B: During temperature rise: Non-alarm area
During temperature fall: Alarm area

LBD differential gap: TC/RTD input: 0.8 °C [°F] (Fixed)
Voltage/current input: 0.8 % of input span (Fixed)

Continued on the next page.

Continued from the previous page.

-  If the LBA function detects an error occurring in the control loop, but cannot specify the location, a check of the control loop in order. The LBA function does not detect a location which causes alarm status. If LBA alarm is ON, check each device or wiring of the control loop.
-  LBA function is not operative when:
 - AT function is activated.
 - The controller is in STOP mode.
 - LBA function is set to “0.”
 - LBA function is not assigned to Event 3 or Event 4.
-  If the LBA time is too short or does not match the controlled object requirements, LBA may turn ON or OFF at inappropriate time or remain OFF. Change the LBA time based on the malfunction.
-  While the LBA is ON (under alarm status), the following conditions cancel the alarm status and LBA will be OFF:
 - The Measured value (PV) rises beyond (or falls below) the LBA determination range within the LBA time.
 - The Measured value (PV) enters within the LBA deadband.

Input 1_set value (SV1)	Data register area for static data read (Byte)	No assignment
	Function number for dynamic data request	28H (40)
Input 2_set value (SV2)	Data register area for static data read (Byte)	No assignment
	Function number for dynamic data request	2EH (46)

The Set value (SV) is a desired value of the control.

Attribute: R/W (Read and Write)



The Input 2_set value (SV2) becomes RO (Read only) for the 1-input controller.

Data range: Setting limiter low to Setting limiter high



Refer to **Input range table (P. 87)**

Factory set value: Input 1_set value (SV1): 0

Input 2_set value (SV2): 0

Related parameters: Setting limiter high (P. 137)

Setting limiter low (P. 138)

Input 1_proportional band	Data register area for static data read (Byte)	No assignment
	Function number for dynamic data request	29H (41)
Input 2_proportional band	Data register area for static data read (Byte)	No assignment
	Function number for dynamic data request	2FH (47)

This value expresses a proportional band of the PI and PID control.

Attribute: R/W (Read and Write)



The Input 2_proportional band becomes RO (Read only) for the 1-input controller.

Data range: Thermocouple (TC)/RTD inputs: 0 (0.0, 0.00) to Input span
Voltage (V)/Current (I) inputs: 0.0 to 1000.0 % of input span
0 (0.0, 0.00): ON/OFF action

Factory set value: Input 1_proportional band: 30.0

Input 2_proportional band: 30.0

Related parameters: ON/OFF action differential gap (upper) (P. 120),

ON/OFF action differential gap (lower) (P. 121)

Input 1_integral time	Data register area for static data read (Byte)	No assignment
	Function number for dynamic data request	2AH (42)
Input 2_integral time	Data register area for static data read (Byte)	No assignment
	Function number for dynamic data request	30H (48)

Integral action is to eliminate offset between SV and PV by proportional action. The degree of Integral action is set by time in seconds.

Attribute: R/W (Read and Write)



The Input 2_integral time becomes RO (Read only) for the 1-input controller.

Data range: 0 to 3600 seconds, 0.0 to 3600.0 seconds or 0.00 to 360.00 seconds
(0, 0.0 or 0.00: PD action)

Factory set value: Input 1_integral time: 240.00
Input 2_integral time: 240.00

Related parameters: Integral/derivative time decimal point position selection (P. 119)

Input 1_derivative time	Data register area for static data read (Byte)	No assignment
	Function number for dynamic data request	2BH (43)
Input 2_derivative time	Data register area for static data read (Byte)	No assignment
	Function number for dynamic data request	31H (49)

Derivative action is to prevent rippling and make control stable by monitoring output change. The degree of Derivative action is set by time in seconds.

Attribute: R/W (Read and Write)



The Input 2_derivative time becomes RO (Read only) for the 1-input controller.

Data range: 0 to 3600 seconds, 0.0 to 3600.0 seconds or 0.00 to 360.00 seconds
(0, 0.0 or 0.00: PI action)

Factory set value: Input 1_derivative time: 60.00
Input 2_derivative time: 60.00

Related parameters: Integral/derivative time decimal point position selection (P. 119)

Input 1_control response parameter	Data register area for static data read (Byte)	No assignment
	Function number for dynamic data request	2CH (44)
Input 2_control response parameter	Data register area for static data read (Byte)	No assignment
	Function number for dynamic data request	32H (50)

The control response for the Set value (SV) change can be selected among Slow, Medium, and Fast.

Attribute: R/W (Read and Write)

 **The Input 2_control response parameter becomes RO (Read only) for the 1-input controller.**

Data range: 0: Slow
1: Medium
2: Fast

Factory set value: Input 1_control response parameter: 0
Input 2_control response parameter: 0

Control Response: The control response for the Set value (SV) change can be selected among Slow, Medium, and Fast. If a fast response is required, Fast is chosen. Fast may cause overshoot. If overshoot is critical, Slow is chosen.

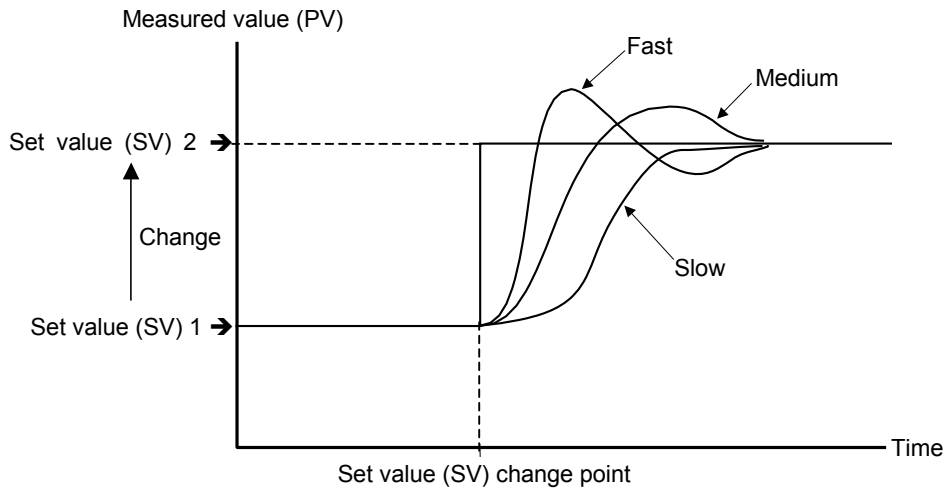

Input 1_ setting change rate limiter (up)	Data register area for static data read (Byte)	No assignment
	Function number for dynamic data request	34H (52)
Input 2_ setting change rate limiter (up)	Data register area for static data read (Byte)	No assignment
	Function number for dynamic data request	36H (54)

This function is to allow the Set value (SV) to be automatically changed at specific rates when a new Set value (SV).

Attribute: R/W (Read and Write)



The Input 2_setting change rate limiter (up) becomes RO (Read only) for the 1-input controller.

Data range: 0 to Input span/unit time * * Unit time: 60 seconds (factory set value)
0: OFF (Unused)
(Varies with the setting of the Decimal point position)

Factory set value: Input 1_setting change rate limiter (up): 0.0
Input 2_setting change rate limiter (up): 0.0

Related parameters: Setting change rate limiter unit time (P. 136)

Input 1_ setting change rate limiter (down)	Data register area for static data read (Byte)	No assignment
	Function number for dynamic data request	35H (53)
Input 2_ setting change rate limiter (down)	Data register area for static data read (Byte)	No assignment
	Function number for dynamic data request	37H (55)

This function is to allow the Set value (SV) to be automatically changed at specific rates when a new Set value (SV).

Attribute: R/W (Read and Write)



The Input 2_setting change rate limiter (down) becomes RO (Read only) for the 1-input controller.

Data range: 0 to Input span/unit time * * Unit time: 60 seconds (factory set value)
0: OFF (Unused)
(Varies with the setting of the Decimal point position)

Factory set value: Input 1_setting change rate limiter (down): 0.0
Input 2_setting change rate limiter (down): 0.0

Related parameters: Setting change rate limiter unit time (P. 136)

Continued on the next page.

Continued from the previous page.

■ Setting change rate limiter

Application examples of Setting change rate limiter:

- Increasing the SV to a higher value

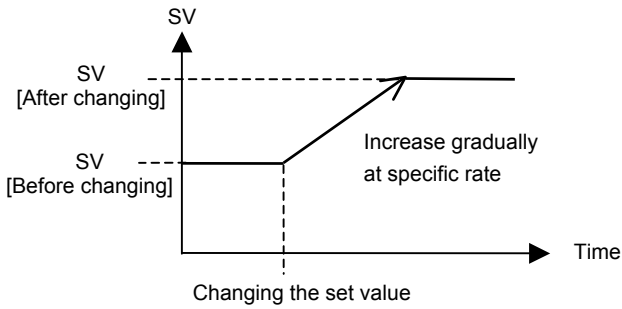

- Decreasing the SV to a lower value

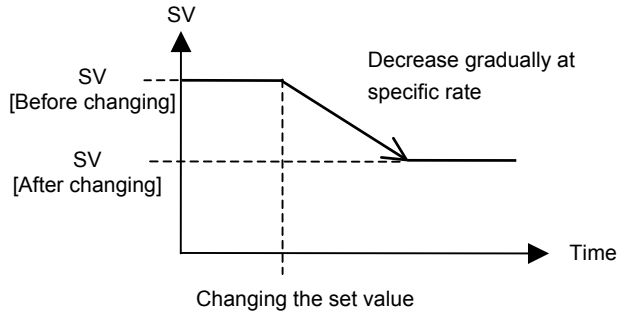

When the Setting change rate limiter is used, the SV will also ramp up or ramp down by the function at power-on and operation mode change from STOP to RUN.



If the Autotuning (AT) function is activated while the SV is ramping up or ramping down by the Setting change rate limiter, AT will start after the SV finishes ramp-up or ramp-down by the limiter, and the controller is in PID control mode until AT starts.



When the value of Setting change rate limiter is changed during normal operation, the ramp-up or ramp-down rate will be changed unless the SV already has finished ramp-up or ramp-down by the function.



If the rate of Setting change limiter is set to any value other than “0.0: OFF (Unused),” the event re-hold action to be taken by a Set value (SV) change becomes invalidated.

Area soak time	Data register area for static data read (Byte)	No assignment
	Function number for dynamic data request	38H (56)

Area soak time is used for Ramp/Soak control function in conjunction with Link area number and Setting change rate limiter (up/down). (refer to P. 72)

Attribute: R/W (Read and Write)

Data range: 0 minute 00.00 second to 9 minutes 59.99 seconds or
0 hour 00 minute 00 second to 9 hours 59 minutes 59 seconds

Factory set value: 0.00.00 (0 minute 00.00 second to 9 minute 59.99 seconds)

Related parameters: Soak time unit selection (P. 136)



The Area soak time can be changed during normal operation with Ramp/Soak control function, but Read the following example carefully how the time change affects Ramp/Soak control time. For example, the Memory area which has 5-minute soak time is executed. When 3 minutes passed, the Area soak time is changed from 5 minutes to 10 minutes. The remaining time of the currently executed Memory area is calculated as follows.
(The new soak time 10 minutes) – (lapsed time 3 minutes) = (remaining time 7 minutes)
The old soak time does not have any effect on remaining time.

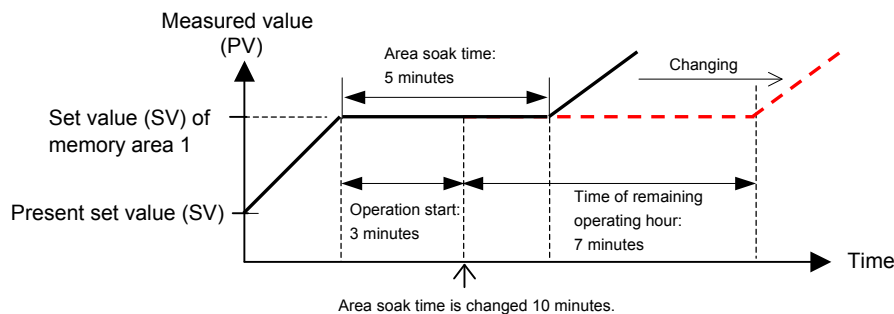

For the instrument with the 2-input specification, its area soaking starts based on the arrival at the memory area set value of Input 1 or that of Input 2, whichever later.

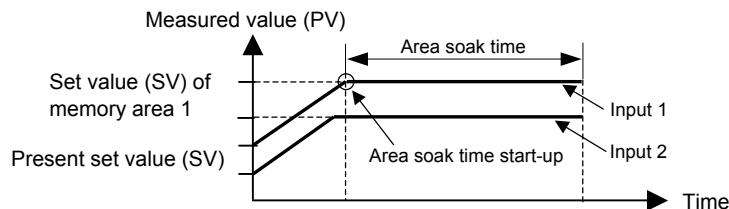

Link area number	Data register area for static data read (Byte)	No assignment
	Function number for dynamic data request	39H (57)

Link area number is used for Ramp/Soak control function in conjunction with Area soak time and Setting change rate limiter (up/down).

Attribute: R/W (Read and Write)

Data range: 0 to 16
0: OFF (No link)

Factory set value: 0

Ramp/Soak Control Function:

Ramp/Soak control is possible by using Area soak time, Link area number and Setting change rate limiter (up/down) in Parameter setting mode.

[Usage example]

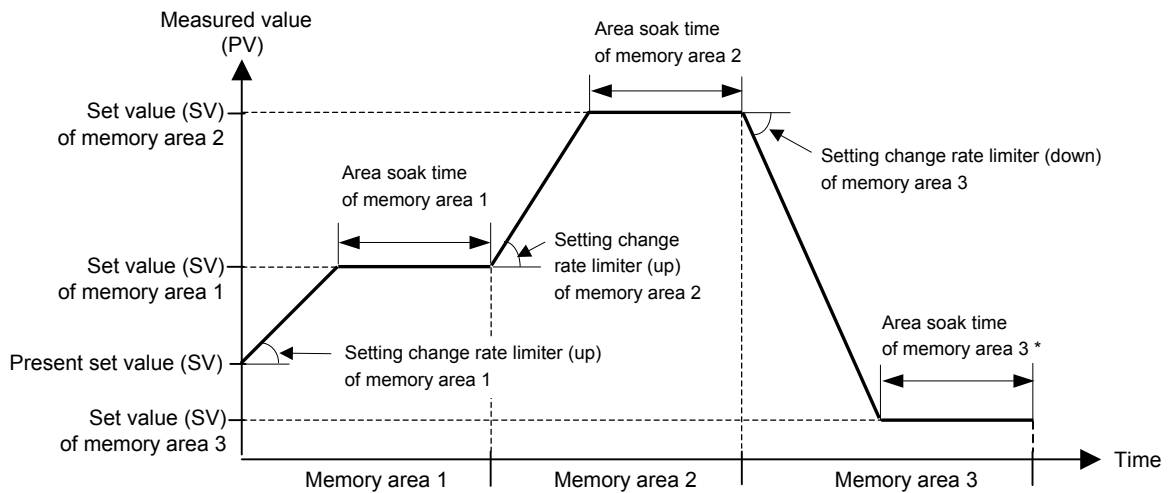

* The Area soak time for the memory area linked last becomes invalidated to continue the state of the Set value (SV) reached.

Heater break alarm 1 (HBA1) set value	Data register area for static data read (Byte)	No assignment
	Function number for dynamic data request	3AH (58)
Heater break alarm 2 (HBA2) set value	Data register area for static data read (Byte)	No assignment
	Function number for dynamic data request	3BH (59)

HBA1 and HBA2 are to set the set values for the heater break alarm (HBA) function. The HBA function detects a fault in the heating circuit by monitoring the current flowing through the load by a dedicated current transformer (CT).

Up to two heater break alarms are available with the controller. CT input 1 is for HBA1, and CT input 2 for HBA2. CT inputs can be assigned to one output from OUT1 to OUT5. To use HBA for a three-phase load, both CT inputs can be assigned to the same output.

Two types of heater break alarms, TYPE “A” and TYPE “B” (factory set value: TYPE “B”), are available. An appropriate type should be selected depending on the application. (Please refer to “Heater break alarm function” below.)

These parameters, HBA set values are used for both types. However, each type has different function and care must be used to set an appropriate set value.

For type “A” HBA,

- Set the set value to approximately 85 % of the maximum reading of the CT input.
- Set the set value to a slightly smaller value to prevent a false alarm depending on the stability of the power supply.
- When more than one heater is connected in parallel, it may be necessary to increase the HBA set value to detect a single heater failure.

For type “B” HBA,

- Set the set value to the maximum CT input value. This will be the current when the control is at 100 % control output. The set value is used to calculate the width of a non-alarm range.

Attribute:

R/W (Read and Write)



Heater break alarm 1 (HBA1) set value becomes RO (Read only) for no current transformer input 1 (CT1) specification.



Heater break alarm 2 (HBA2) set value becomes RO (Read only) for no current transformer input 2 (CT2) specification.

Data range:

With CTL-6-P-N: 0.0 to 30.0 A (0.0: Not used)
With CTL-12-S56-10L-N: 0.0 to 100.0 A (0.0: Not used)

Factory set value:

Heater break alarm 1 (HBA1) set value: 0.0
Heater break alarm 2 (HBA2) set value: 0.0

Related parameters:

Heater break determination point (P. 81),
Heater melting determination point (P. 82),
Heater break alarm (HBA) type selection (P. 141),
Number of heater break alarm (HBA) delay times (P. 142)

Continued on the next page.

Continued from the previous page.

Heater break alarm function:

■ **Heater break alarm (HBA) type A**

Heater break alarm (HBA) type A can only be used with time-proportional control output (relay, voltage pulse, or triac output). The HBA function monitors the current flowing through the load by a dedicated current transformer (CT), compares the measured value with the HBA set values, and detects a fault in the heating circuit.

Low or No current flow (Heater break, malfunction of the control device, etc.):

When the control output is ON and the CT input value is equal to or less than the heater break determination point for the preset number of consecutive sampling cycles, an alarm is activated.

Over current or short-circuit:

When the control output is OFF and the CT input value is equal to or greater than the heater break determination point for the preset number of consecutive sampling cycles, an alarm is activated.

■ **Heater break alarm (HBA) type B**

Heater Break Alarm (HBA) type B can be used with both continuous control output (current/voltage continuous output) and time-proportional control output (relay, voltage pulse output, or triac). The HBA function assumes that the heater current value is proportional* to the control output value of the controller, otherwise viewed as the manipulated variable (MV), and compare it with the CT input value to detect a fault in the heating or cooling circuit.

* It is assumed that the current value flowing through the load is at maximum when the control output from the controller is 100 %, and the minimum current value flowing through the load is zero (0) when the control output from the controller is 0 %.

Low or No current flow (Heater break, malfunction of the control device, etc.)

The alarm determination point (Low) is calculated as follows:

$$[\text{Non-alarm range (Low) width}] = (\text{HbL1 or HbL2}) \times (\text{HbA1 or HbA2})$$

$$[\text{Alarm determination point (Low)}] = [(\text{HbA1 or HbA2}) \times (\text{MV1 or MV2})] - [\text{Non-alarm range (Low) width}]$$

When the CT input value is equal to or less than the heater break determination point for the preset number of consecutive sampling cycles, an alarm status is produced.

Over current or short-circuit

The alarm determination point (High) is calculated as follows:

$$[\text{Non-alarm range (High) width}] = (\text{HbH1 or HbH2}) \times (\text{HbA1 or HbA2})$$

$$[\text{Alarm determination point (High)}] = [(\text{HbA1 or HbA2}) \times (\text{MV1 or MV2})] + [\text{Non-alarm range (High) width}]$$

When the CT input value is equal to or greater than the heater melting determination point for the preset number of consecutive sampling cycles, an alarm status is produced.

Continued on the next page.

Continued from the previous page.

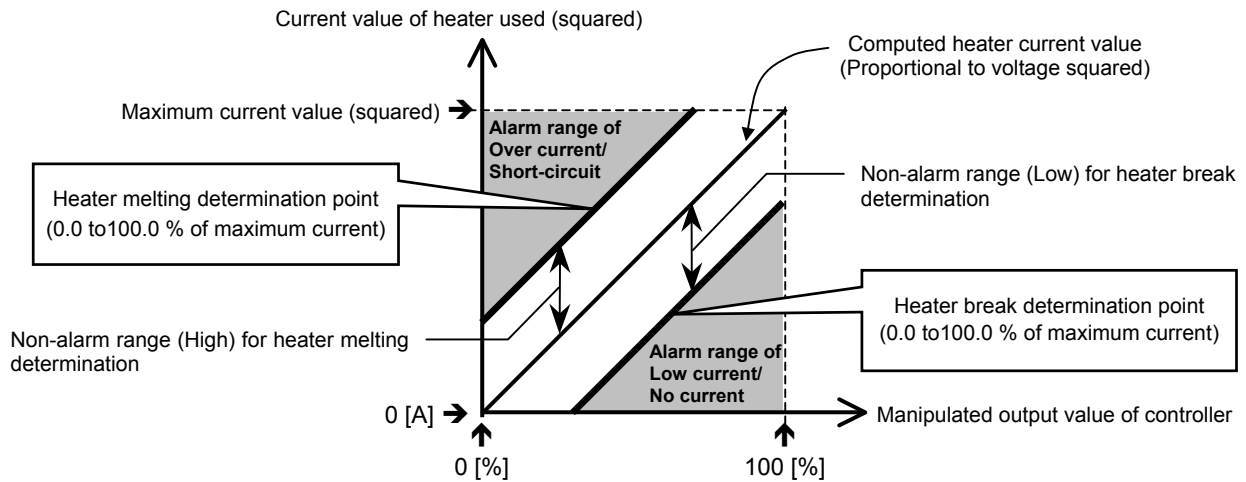

The current factory set values of HbLs (Heater break determination point) and HbHs (Heater melting determination point) are set to 30.0 %. If any of the following conditions exists, set them to a slightly larger value to prevent a false alarm.

- Heater current values is not proportional to the control output in Phase control.
- There is difference on control output accuracy between the controller and the operating unit (scr Power Controller).
- There is a delay on control output between the controller and the operating unit (scr Power Controller).



The factory set value of the HBA type is heater break alarm (HBA) type B.

Input 1_PV bias	Data register area for static data read (Byte)	No assignment
	Function number for dynamic data request	3CH (60)
Input 2_PV bias	Data register area for static data read (Byte)	No assignment
	Function number for dynamic data request	42H (66)

PV bias adds bias to the Measured value (PV). The PV bias is used to compensate the individual variations of the sensors or correct the difference between the Measured value (PV) of other instruments.

Attribute: R/W (Read and Write)



The Input 2_PV bias becomes RO (Read only) for the 1-input controller.

Data range: -Input span to +Input span

Factory set value: Input 1_PV bias: 0

Input 2_PV bias: 0

Input 1_PV digital filter	Data register area for static data read (Byte)	No assignment
	Function number for dynamic data request	3DH (61)
Input 2_PV digital filter	Data register area for static data read (Byte)	No assignment
	Function number for dynamic data request	43H (67)

This item is the time of the first-order lag filter eliminate noise against the measured input.

Attribute: R/W (Read and Write)



The Input 2_PV digital filter becomes RO (Read only) for the 1-input controller.

Data range: 0.00 to 10.00 seconds
0.00: OFF (Unused)

Factory set value: HA400/900: Input 1_PV digital filter: 0.00
Input 2_PV digital filter: 0.00
HA401/901: Input 1_PV digital filter: 1.00
Input 2_PV digital filter: 1.00

Input 1_PV ratio	Data register area for static data read (Byte)	No assignment
	Function number for dynamic data request	3EH (62)
Input 2_PV ratio	Data register area for static data read (Byte)	No assignment
	Function number for dynamic data request	44H (68)

PV ratio is a multiplier to be applied to the Measured value (PV). The PV bias is used to compensate the individual variations of the sensors or correct the difference between the Measured value (PV) of other instruments.

Attribute: R/W (Read and Write)



The Input 2_PV ratio becomes RO (Read only) for the 1-input controller.

Data range: 0.500 to 1.500

Factory set value: Input 1_PV ratio: 1.000
Input 2_PV ratio: 1.000

Input 1_PV low input cut-off	Data register area for static data read (Byte)	No assignment
	Function number for dynamic data request	3FH (63)
Input 2_PV low input cut-off	Data register area for static data read (Byte)	No assignment
	Function number for dynamic data request	45H (69)

PV low input cut-off is used with Square root extraction function. The measured value less than the PV low input cut-off is ignored to prevent control disturbance caused by input variation at low measured value range.

Attribute: R/W (Read and Write)

 **This item becomes RO (Read only) during control RUN.**

Data range: 0.00 to 25.00 % of input span

Factory set value: Input 1_PV low input cut-off: 0.00

Input 2_PV low input cut-off: 0.00

PV Low Input Cut-off Function:

When input signal square root extraction is used for flow control, etc., the square root extraction result varies widely at the low measured value range. The measured value less than the PV low input cut-off is ignored to calculate control output in order to prevent control disturbance caused by input variation at low measured value range.

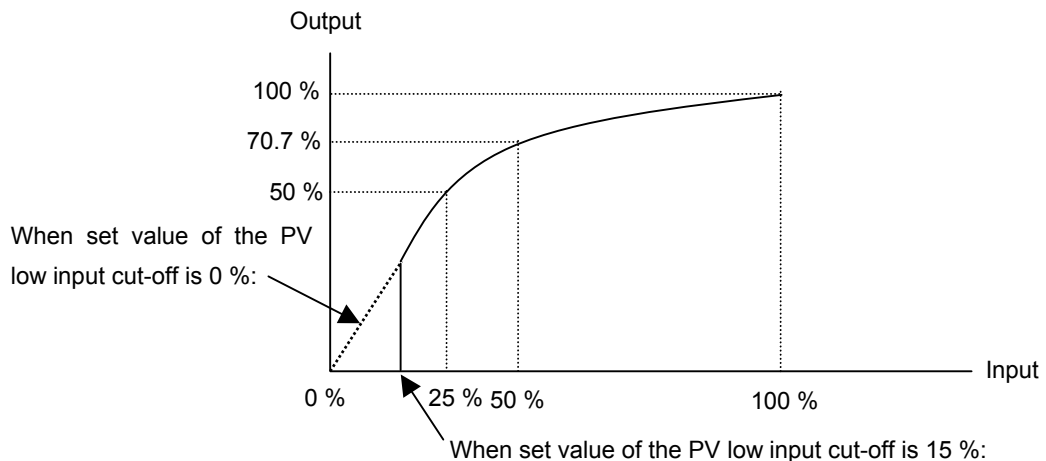

Input 1_proportional cycle time	Data register area for static data read (Byte)	No assignment
	Function number for dynamic data request	40H (64)
Input 2_proportional cycle time	Data register area for static data read (Byte)	No assignment
	Function number for dynamic data request	46H (70)

Proportional cycle time is to set control cycle time for time based control output such as voltage pulse for SSR, triac and relay output.

Attribute: R/W (Read and Write)

 **This item becomes RO (Read only) for the voltage/current output specification.**

Data range: 0.1 to 100.0 seconds

Factory set value: Input 1_proportional cycle time:
 Relay contact output: 20.0 seconds
 Voltage pulse output and triac output: 2.0 seconds
 Input 2_proportional cycle time:
 Relay contact output: 20.0 seconds
 Voltage pulse output and triac output: 2.0 seconds

 The proportional cycle time becomes invalidated when the Voltage/Current output is selected as control output type.

Input 1_manual output value	Data register area for static data read (Byte)	No assignment
	Function number for dynamic data request	41H (65)
Input 2_manual output value	Data register area for static data read (Byte)	No assignment
	Function number for dynamic data request	47H (71)

This item is the output value in the manual (MAN) control.

Attribute: R/W (Read and Write)

 **This item becomes RO (Read only) for the automatic (AUTO) control.**

Data range: Output limiter low to Output limiter high

Factory set value: Input 1_manual output value: 0.0
 Input 2_manual output value: 0.0

Related parameters: Output limiter high/low (P. 126)

Set lock level	Data register area for static data read (Byte)	No assignment
	Function number for dynamic data request	48H (72)

The set lock level restricts parameter setting changes by key operation (Set data lock function). This function prevents the operator from making errors during operation.

Attribute: R/W (Read and Write)

Data range: 0 to 7 (Bit data)

Bit 0 to Bit 2 are used. (Bit 3 to Bit 31: Unused)

The set lock level is assigned as a bit image in binary numbers.

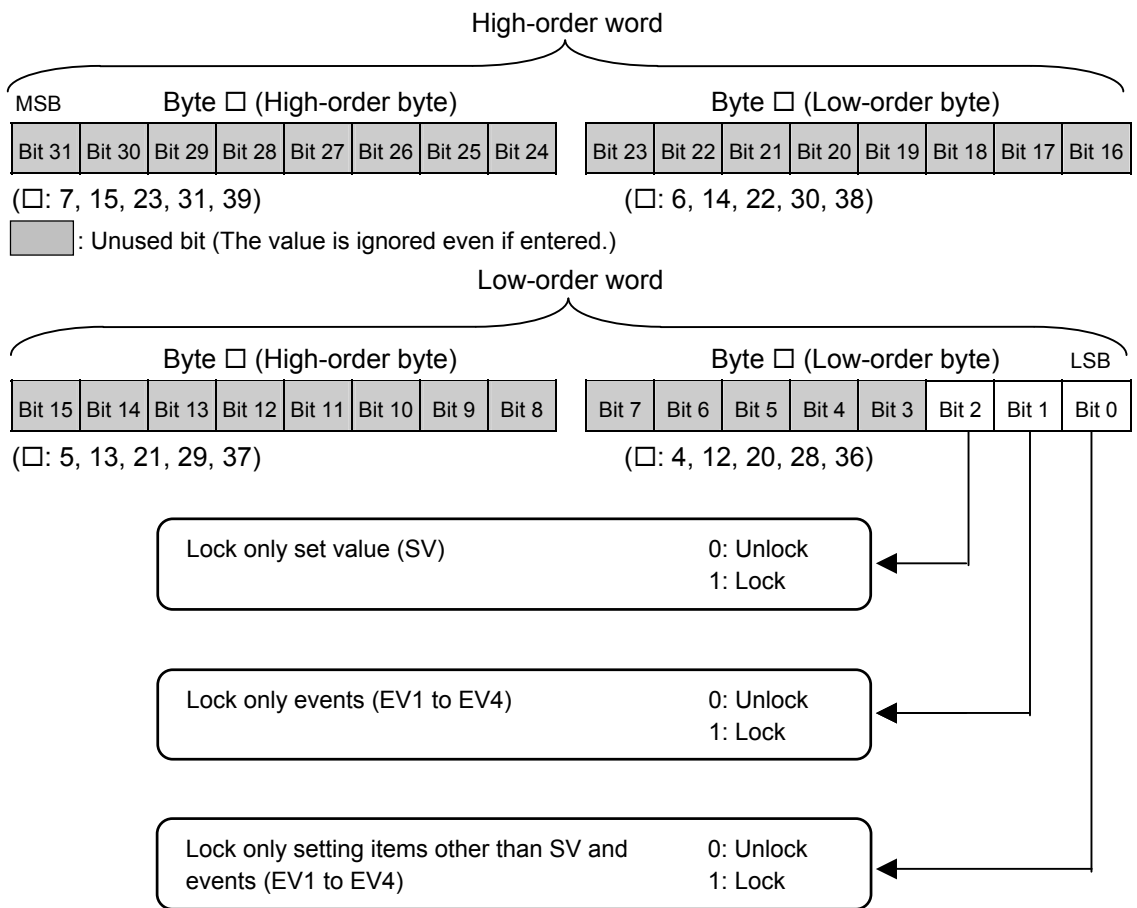

Factory set value: 0

EEPROM storage state	Data register area for static data read (Byte)	No assignment
	Function number for dynamic data request	49H (73)

The contents of the RAM and those of the EEPROM can be checked.

Attribute: RO (Read only)

Data range: 0: The content of the EEPROM does not coincide with that of the RAM.

- As data is being written to the EEPROM when the EEPROM storage mode is selected “0: Set values are store to the EEPROM when set values are changed,” do not turn the power off. If turned off, no set values are stored.
- If the EEPROM storage mode is changed after “0: Set values are store to the EEPROM when set values are changed” is changed to “1: Not set values are store to the EEPROM when set values are changed,” 0 is set (mismatch). As the set value changed is not backup, select the backup mode if necessary.

1: The content of the EEPROM coincides with that of the RAM.
The contents of the RAM match with those of the EEPROM.
(Data write to the EEPROM is completed.)

Factory set value: —

EEPROM storage mode	Data register area for static data read (Byte)	No assignment
	Function number for dynamic data request	4AH (74)

It is set whether the data storage in the non-volatile memory (EEPROM) is executed or not.

Attribute: R/W (Read and Write)

Data range: 0: Set values are store to the EEPROM when set values are changed.
1: Not set values are store to the EEPROM when set values are changed.

Factory set value: 0



When the memory is used to frequently change the set value via communication, select “1: Not set values are store to the EEPROM when set values are changed.”



For the following case, data is stored into the EEPROM regardless of the EEPROM mode setting.

- **When the data is changed through key operation**
- **Data written into the controller by specifying the memory area number**



The non-volatile memory (EEPROM) has limitations on the number of memory rewrite times. If “1: Not set values are store to the EEPROM when set values are changed” is selected as the EEPROM storage mode, all of the set values changed are not written to the EEPROM and thus a problem of limitations on the number of memory rewrite times can be solved.

Continued on the next page.

Continued from the previous page.



When selecting any EEPROM storage mode, take notice of the following.

- If power failure occurs while “1: Not set values are store to the EEPROM when set values are changed” is selected, the set value returns to the value before the storage mode is selected.
- If “1: Not set values are store to the EEPROM when set values are changed” is changed to “0: Set values are store to the EEPROM when set values are changed,” all of the set values at that time are stored to the EEPROM. If necessary to backup the final value of each set item, select “0: Set values are store to the EEPROM when set values are changed.”
- When the power is turned on, “0: Set values are store to the EEPROM when set values are changed” is always set.

Heater break determination point 1	Data register area for static data read (Byte)	No assignment
	Function number for dynamic data request	4BH (75)
Heater break determination point 2	Data register area for static data read (Byte)	No assignment
	Function number for dynamic data request	4DH (77)

Set the heater break determination point for the heater break alarm (HBA) type B.

Attribute: R/W (Read and Write)



Heater break determination point 1 set value becomes RO (Read only) for no current transformer input 1 (CT1) specification and heater break alarm (HBA) type A.



Heater break determination point 2 set value becomes RO (Read only) for no current transformer input 2 (CT2) specification and heater break alarm (HBA) type A.

Data range: Heater break determination point 1:
0.0 to 100.0 % of heater break alarm 1 (HBA1) set value
(0.0: Heater break determination is invalidated)
Heater break determination point 2:
0.0 to 100.0 % of heater break alarm 2 (HBA2) set value
(0.0: Heater break determination is invalidated)

Factory set value: Heater break determination point 1: 30.0
Heater break determination point 2: 30.0

Related parameters: Heater break alarm (HBA) set value (P. 73),
Heater melting determination point (P. 82),
Heater break alarm (HBA) type selection (P. 141),
Number of heater break alarm (HBA) delay times (P. 142)

Functional description:
Refer to Heater break alarm (HBA) set value (P. 73)

Heater melting determination point 1	Data register area for static data read (Byte)	No assignment
	Function number for dynamic data request	4CH (76)
Heater melting determination point 2	Data register area for static data read (Byte)	No assignment
	Function number for dynamic data request	4EH (78)

Set the heater melting determination point for the heater break alarm (HBA) type B.

Attribute: R/W (Read and Write)



Heater melting determination point 1 set value becomes RO (Read only) for no current transformer input 1 (CT1) specification and heater break alarm (HBA) type A.



Heater melting determination point 2 set value becomes RO (Read only) for no current transformer input 2 (CT2) specification and heater break alarm (HBA) type A.

Data range: Heater melting determination point 1:
0.0 to 100.0 % of heater break alarm 1 (HBA1) set value
(0.0: Heater melting determination is invalidated)
Heater melting determination point 2:
0.0 to 100.0 % of heater break alarm 2 (HBA2) set value
(0.0: Heater melting determination is invalidated)

Factory set value: Heater melting determination point 1: 30.0
Heater melting determination point 2: 30.0

Related parameters: Heater break alarm (HBA) set value (P. 73),
Heater break determination point (P. 81),
Heater break alarm (HBA) type selection (P. 141),
Number of heater break alarm (HBA) delay times (P. 142)

Functional description:
Refer to Heater break alarm (HBA) set value (P. 73)

STOP display selection	Data register area for static data read (Byte)	No assignment
	Function number for dynamic data request	64H (100)

STOP message for control STOP mode can be displayed either on the upper display or the lower display. This item is to select the display to show the STOP message.

Attribute: R/W (Read and Write)



This item becomes RO (Read only) during control RUN.

Data range: 0: Displays on the measured value (PV1/PV2) unit (TYPE 1)

1: Displays on the set value (SV) unit (TYPE 2)

Factory set value: 0



There are three different Characters for STOP mode depending on how to be transferred from RUN to STOP.

	(KSTP)	(dSTP)	(SToP)
TYPE1:			
TYPE2:			
	(KSTP)	(dSTP)	(SToP)

Bar graph display selection	Data register area for static data read (Byte)	No assignment
	Function number for dynamic data request	65H (101)

Use to select the contents of the bar graph display.

Attribute: R/W (Read and Write)

 **This item becomes RO (Read only) during control RUN.**





Data range:

- 0: No display
- 1: Input 1_manipulated output value (MV)
- 2: Input 1_measured value (PV)
- 3: Input 1_set value (SV)
- 4: Input 1_deviation value
- 5: Feedback resistance input value (POS)
- 6: Input 2_manipulated output value (MV)
- 7: Input 2_measured value (PV)
- 8: Input 2_set value (SV)
- 9: Input 2_deviation value

Factory set value: 0

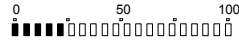
Related parameters: Bar graph resolution setting (P. 85)

 Bar graph display explanation:

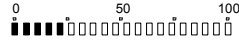
Manipulated output value (MV) display	<p>Displays the Manipulated output value (MV). When Manipulated output value (MV) is at 0 % or less, the left-end dot of the bar-graph flashes. When MV exceeds 100 %, the right-end dot flashes.</p> <p>[Display example] </p>
Measured value (PV) display	<p>Scaling is available within the input range.</p> <p>[Display example] </p>
Set value (SV) display	<p>Displays the Set value (SV). Scaling is available within the input range.</p> <p>[Display example] </p>
Deviation value display	<p>Displays the deviation between the Measured value (PV) and the Set value (SV). When the Deviation display is selected, the dots at both ends of bar-graph light. A display resolution per dot is settable from 1 to 100.</p> <p>[Display example] </p>
Feedback resistance input value (POS) display	<p>Displays the Feedback resistance input value (POS). It is available only with position proportioning PID control.</p> <p>[Display example] </p>

The number of dot points: 10 dots (HA400/401) 20 dots (HA900/901)

Bar graph resolution setting	Data register area for static data read (Byte)	No assignment
	Function number for dynamic data request	66H (102)

Use to set the bar graph display resolution for the deviation display. However, this set value becomes validated only when the bar graph display selection is “4: Input 1_deviation value” or “9: Input 2_deviation value.”

Attribute: R/W (Read and Write)



This item becomes RO (Read only) during control RUN.

Data range: 1 to 100 digit/dot
Sets several digit per 1 dots of the bar graph.

Factory set value: 100

Related parameters: Bar graph display selection (P. 84)

Auto/Manual transfer key operation selection (A/M)	Data register area for static data read (Byte)	No assignment
	Function number for dynamic data request	68H (104)

Use to select Use/Unuse of Auto/Manual transfer key (A/M).

Attribute: R/W (Read and Write)



This item becomes RO (Read only) during control RUN.

Data range: 0: Unused
1: Auto/Manual transfer for input 1
2: Auto/Manual transfer for input 2
3: Common Auto/Manual transfer for input 1 and input 2

Factory set value: 3

Remote/Local transfer key operation selection (R/L)	Data register area for static data read (Byte)	No assignment
	Function number for dynamic data request	69H (105)

Use to select Use/Unuse of Remote/Local transfer key (R/L).

Attribute: R/W (Read and Write)



This item becomes RO (Read only) during control RUN.

Data range: 0: Unused
1: Remote/Local transfer

Factory set value: 1

RUN/STOP transfer key operation selection (R/S)	Data register area for static data read (Byte)	No assignment
	Function number for dynamic data request	6AH (106)

Use to select Use/Unuse of RUN/STOP transfer key (R/S).

Attribute: R/W (Read and Write)



This item becomes RO (Read only) during control RUN.

Data range: 0: Unused
1: RUN/STOP transfer

Factory set value: 1

Input 1_input type selection	Data register area for static data read (Byte)	No assignment
	Function number for dynamic data request	6B (107)
Input 2_input type selection	Data register area for static data read (Byte)	No assignment
	Function number for dynamic data request	75H (117)

Attribute: R/W (Read and Write)

 **This item becomes RO (Read only) during control RUN.**

Data range: 0 to 23 (refer to the following table)

[Input Range Table]

Set value	Input type	Input range	Hardware
0	TC input	K	Voltage (Low) input group
1		J	
2		R	
3		S	
4		B	
5		E	
6		N	
7		T	
8		W5Re/W26Re	
9		PLII	
19	Voltage (Low) input	0 to 1 V	Programmable range (-19999 to +99999)
20		0 to 100 mV	
21		0 to 10 mV	
12	RTD input	3-wire system Pt100	Programmable range (-19999 to +99999)
13		3-wire system JPt100	
22		4-wire system Pt100	
23		4-wire system JPt100	
14	Current input	0 to 20 mA	Programmable range (-19999 to +99999)
15		4 to 20 mA	
16	Voltage (High) input	0 to 10 V	Programmable range (-19999 to +99999)
17		0 to 5 V	
18		1 to 5 V	



An input type change may only be made within the hardware groups as shown above.



Do not set to any number (including 10 and 11) which is not described in the input range table above. This may cause malfunctioning.



4-wire RTD input type (22 and 23) can not be selected for Input type selection of Input 2 (2.InP).



Refer to the above input range table to select input type of the remote input. Input range 0 through 13, 22 or 23 can not be selected for.

Factory set value: Input 1_input type selection: Depend on model code. (when not specifying: Type K)
Input 2_input type selection: Depend on model code. (when not specifying: Type K)

Related parameters: Display unit selection (P. 88), Decimal point position (P. 88),
Input scale high (P. 89), Input scale low (P. 90)

Input 1_display unit selection	Data register area for static data read (Byte)	No assignment
	Function number for dynamic data request	6CH (108)
Input 2_display unit selection	Data register area for static data read (Byte)	No assignment
	Function number for dynamic data request	76H (118)

Use to select the temperature unit for thermocouple (TC) and RTD inputs.

Attribute: R/W (Read and Write)

 **This item becomes RO (Read only) during control RUN.**

Data range: 0: °C

1: °F

Factory set value: Input 1_display unit selection: 0

Input 2_display unit selection: 0

Input 1_decimal point position	Data register area for static data read (Byte)	No assignment
	Function number for dynamic data request	6DH (109)
Input 2_decimal point position	Data register area for static data read (Byte)	No assignment
	Function number for dynamic data request	77H (119)

Use to select the decimal point position of the input range.

Attribute: R/W (Read and Write)

 **This item becomes RO (Read only) during control RUN.**

Data range: Thermocouple (TC) inputs: 0: No decimal place

1: One decimal place

RTD inputs: 0: No decimal place

1: One decimal place

2: Two decimal places

Voltage (V)/Current (I) inputs: 0: No decimal place

1: One decimal place

2: Two decimal places

3: Three decimal places

4: Four decimal places

Factory set value: Input 1_decimal point position: 1

Input 2_decimal point position: 1

Related parameters: Input type selection (P. 87), Input scale high (P. 89),
Input scale low (P. 90)

Input 1_input scale high	Data register area for static data read (Byte)	No assignment
	Function number for dynamic data request	6EH (110)
Input 2_input scale high	Data register area for static data read (Byte)	No assignment
	Function number for dynamic data request	78H (120)

This value is high limit of the input scale range.

Attribute: R/W (Read and Write)



This item becomes RO (Read only) during control RUN.

Data range: Thermocouple (TC)/RTD inputs:
 Input scale low to Maximum value of the selected input range
 Voltage (V)/Current (I) inputs:
 -19999 to +99999
 (Varies with the setting of the decimal point position)

Factory set value: Input 1_input scale high:
 Thermocouple (TC)/RTD inputs: Maximum value of the selected input range
 Voltage (V)/Current (I) inputs: 100.0
 Input 2_input scale high:
 Thermocouple (TC)/RTD inputs: Maximum value of the selected input range
 Voltage (V)/Current (I) inputs: 100.0

Related parameters: Input type selection (P. 87), Decimal point position (P. 88),
 Input scale low (P. 90)

Input Scale High function:
 The input scale range can be easily set by setting the input scale high limit/low limit.



When a Voltage/Current input type is selected, the Input scale high can be set lower than the Input scale low. (Input scale high < Input scale low)

Input 1_input scale low	Data register area for static data read (Byte)	No assignment
	Function number for dynamic data request	6FH (111)
Input 2_input scale low	Data register area for static data read (Byte)	No assignment
	Function number for dynamic data request	79H (121)

This value is to set the low limit of the input scale range.

Attribute: R/W (Read and Write)



This item becomes RO (Read only) during control RUN.

Data range: Thermocouple (TC)/RTD inputs:
 Minimum value of the selected input range to Input scale high
 Voltage (V)/Current (I) inputs:
 -19999 to +99999
 (Varies with the setting of the decimal point position)

Factory set value: Input 1_input scale low:
 Thermocouple (TC)/RTD inputs: Minimum value of the selected input range
 Voltage (V)/Current (I) inputs: 0.0
 Input 2_input scale low:
 Thermocouple (TC)/RTD inputs: Minimum value of the selected input range
 Voltage (V)/Current (I) inputs: 0.0

Related parameters: Input type selection (P. 87), Decimal point position (P. 88),
 Input scale high (P. 89)

Input Scale Low function:
 Refer to the input scale high.



When a Voltage/Current input type is selected, the Input scale high can be set lower than the Input scale low. (Input scale high < Input scale low)

Input 1_input error determination point (low)	Data register area for static data read (Byte)	No assignment
	Function number for dynamic data request	71H (113)
Input 2_input error determination point (low)	Data register area for static data read (Byte)	No assignment
	Function number for dynamic data request	7BH (123)

Use to set Input error determination point (low). Input error determination function is activated when a measured value reaches the limit, and control output value selected by Action at input error will be output.

Attribute: R/W (Read and Write)



This item becomes RO (Read only) during control RUN.

Data range: Input scale low – (5 % of input span) to Input scale high + (5 % of input span)

Factory set value: Input 1_input error determination point (low):

Thermocouple (TC)/RTD inputs: Input scale low – (5 % of input span)

Voltage (V)/Current (I) inputs: –5.0

Input 2_input error determination point (low):

Thermocouple (TC)/RTD inputs: Input scale low – (5 % of input span)

Voltage (V)/Current (I) inputs: –5.0

Related parameters: Input error determination point (high) (P. 91),
Action at input error (high) (P. 122),
Action at input error (low) (P. 123),
Manipulated output value at input error (P. 123)

Input 1_burnout direction	Data register area for static data read (Byte)	No assignment
	Function number for dynamic data request	72H (114)
Input 2_burnout direction	Data register area for static data read (Byte)	No assignment
	Function number for dynamic data request	7CH (124)

Use to select Burnout direction in input break. When input break is detected by the controller, the measured value go either Upscale or Downscale according to the Burnout Direction setting.

Attribute: R/W (Read and Write)



This item becomes RO (Read only) during control RUN.

Data range: 0: Upscale
1: Downscale

Factory set value: Input 1_burnout direction: 0
Input 2_burnout direction: 0



The action in the input breaks fix regardless of setting a burnout direction about the following input.

- **RTD inputs:** Upscale
- **Voltage (High) inputs:** Downscale (Indicates value near 0 V.)
- **Current (I) inputs:** Downscale (Indicates value near 0 mA.)

Input 1_square root extraction selection	Data register area for static data read (Byte)	No assignment
	Function number for dynamic data request	73H (115)
Input 2_square root extraction selection	Data register area for static data read (Byte)	No assignment
	Function number for dynamic data request	7DH (125)

Use to select Use/Unuse of the square root extraction for the measured value.

Attribute: R/W (Read and Write)



This item becomes RO (Read only) during control RUN.

Data range: 0: Unused
1: Used

Factory set value: Input 1_square root extraction selection: 0
Input 2_square root extraction selection: 0

Square root extraction function:

The controller can receive the input signal directly from a differential pressure type flow transmitter by using Square root extraction function without using a square root extractor.

Power supply frequency selection	Data register area for static data read (Byte)	No assignment
	Function number for dynamic data request	74H (116)

Use to select the power supply frequency of the controller suited to the application.

Attribute: R/W (Read and Write)



This item becomes RO (Read only) during control RUN.

Data range: 0: 50 Hz
1: 60 Hz

Factory set value: 0

Event input logic selection	Data register area for static data read (Byte)	No assignment
	Function number for dynamic data request	7EH (126)

Use to assign the function (memory area, operation mode) for the event inputs (DI 1 to DI 7).

Attribute: R/W (Read and Write)

 **This item becomes RO (Read only) during control RUN.**

Data range: 0 to 6 (refer to the following table)

[Function Assignment Table]

Set value	DI 1	DI 2	DI 3	DI 4	DI 5	DI 6	DI 7
	Terminal No. 30-31	Terminal No. 30-32	Terminal No. 30-33	Terminal No. 30-34	Terminal No. 35-36	Terminal No. 13-14	Terminal No. 13-15
0	Unused (No function assignment)						
1	Memory area number selection (1 to 16)				Memory area set	RUN/STOP transfer	Auto/Manual transfer
2	Memory area number selection (1 to 16)				Memory area set	RUN/STOP transfer	Remote/Local transfer
3	Memory area number selection (1 to 16)				Memory area set	Remote/Local transfer	Auto/Manual transfer
4	Memory area number selection (1 to 8)			Memory area set	RUN/STOP transfer	Remote/Local transfer	Auto/Manual transfer
5	Memory area number selection (1 to 8)			Memory area set	Remote/Local transfer	Unused	Unused
6	Memory area number selection (1 to 8)			Memory area set	Auto/Manual transfer	Unused	Unused

 **DI 6 and DI 7 cannot be used when the Communication 1 function is specified.**

 Event input terminals

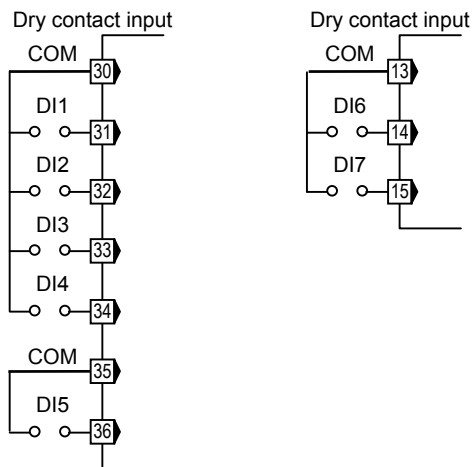

Contact input from external devices or equipment should be dry contact input. If it is not dry contact input, the input should meet the specification below.

Contact resistance: At OFF (contact open) 500 kΩ or more
At ON (contact closed) 10 Ω or less

Factory set value: 1

Event Input function: Refer to the next page.

Continued on the next page.

Continued from the previous page.

- Contact status of memory area number selection



To store a new Memory Area number as the Control Area, close the DI for Memory Area Set.

Event input	Memory area number															
	1	2	3	4	5	6	7	8	9	10	11	12	13	14	15	16
DI 1	×	–	×	–	×	–	×	–	×	–	×	–	×	–	×	–
DI 2	×	×	–	–	×	×	–	–	×	×	–	–	×	×	–	–
DI 3	×	×	×	×	–	–	–	–	×	×	×	×	–	–	–	–
DI 4	×	×	×	×	×	×	×	×	–	–	–	–	–	–	–	–

×: Contact open –: Contact closed

Transfer timing of memory area number:

[Example] Change the memory area number to 6
(when “4” is selected in “Event input logic selection”)

First, close the contacts between DI1 and DI3 and the common terminal. Next, open the contact between DI2 and the common. Then, close the contact between DI4 and the common from open status, the memory area in the controller will change to “6.”

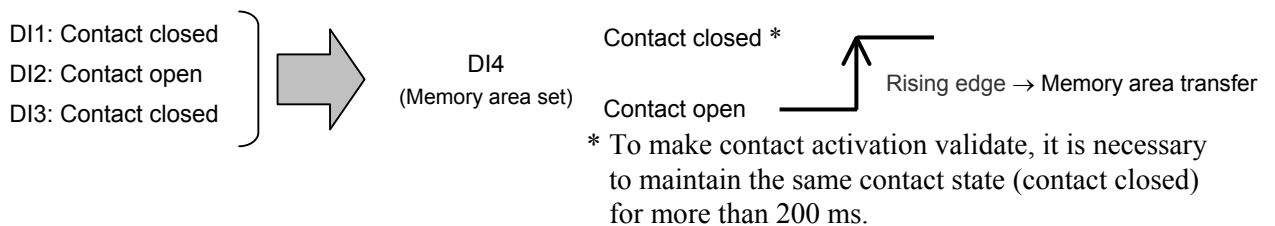

- DI Status for mode transfer

	Contact closed	Contact open	No event input or not selected
RUN/STOP transfer	RUN (Control RUN)	STOP (Control STOP)	RUN (Control RUN)
Auto/Manual transfer	Auto	Manual	Auto
Remote/Local transfer *	Remote or cascade control	Local	Local

* If “Input 2_use selection (CAM)” is changed to “2: Cascade control (Slave),” “Remote/Local” needs to be changed to “Cascade/Local.”

- RUN/STOP transfer

Mode select from front key or communication	Status of event input (DI)	Actual operation mode
RUN (Control RUN)	Contact closed	RUN (Control RUN)
	Contact open	STOP (Control STOP)
STOP (Control STOP)	Contact closed	
	Contact open	

Continued on the next page.

Continued from the previous page.

● **Auto/Manual transfer**

Mode select from front key or communication	Status of event input (DI)	Actual operation mode
Auto	Contact closed	Auto
	Contact open	Manual
Manual	Contact closed	
	Contact open	

● **Remote/Local transfer**

Mode select from front key or communication	Status of event input (DI)	Actual operation mode
Remote	Contact closed	Remote
	Contact open	Local
Local	Contact closed	
	Contact open	

Transfer timing of RUN/STOP, Auto/Manual, and Remote/Local:

The selection operation is taken when DI contact is closed from the open condition (Rising edge).

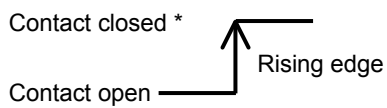

* To make contact activation validate, it is necessary to maintain the same contact state (contact closed) for more than 200 ms.

Output logic selection	Data register area for static data read (Byte)	No assignment
	Function number for dynamic data request	7FH (127)

This is used to assign the output function (control output, event, etc.) for the output (OUT1 to OUT5).

Attribute: R/W (Read and Write)



This item becomes RO (Read only) during control RUN.

Data range: 1 to 11 (refer to the following table)

(M: Relay contact output, V: Voltage pulse output, R: Current output, E: Voltage, T: Triac output)

Set value	OUT1 (M/ V / R/ E/ T)	OUT2 (M/ V/ R/ E/ T)	OUT3 (M/ V/ R/ E/ T)	OUT4 (M)	OUT5 (M)	Remarks
1	MV 1	HBA 1 (Energized) or HBA 2 (Energized)	EV 3 (Energized) or EV 4 (Energized)	EV 2 (Energized)	EV 1 (Energized)	—
2	MV 1	HBA 1 (De-energized) or HBA 2 (De-energized)	EV 3 (De-energized) or EV 4 (De-energized)	EV 2 (De-energized)	EV 1 (De-energized)	—
3	MV 1	EV 3 (Energized), EV 4 (Energized), HBA 1 (Energized) or HBA 2 (Energized)	EV 2 (Energized)	EV 1 (Energized)	FAIL (De-energized)	Energized alarm corresponding to FAIL output
4	MV 1	EV 3 (De-energized), EV 4 (De-energized), HBA 1 (De-energized) or HBA 2 (De-energized)	EV 2 (De-energized)	EV 1 (De-energized)	FAIL (De-energized)	De-energized alarm corresponding to FAIL output
5	MV 1	MV 2	EV 4 (Energized) or HBA 2 (Energized)	EV 3 (Energized) or HBA 1 (Energized)	EV 1 (Energized) or EV2 (Energized)	Energized alarm corresponding to two loops control
6	MV 1	MV 2	EV 4 (De-energized) or HBA 2 (De-energized)	EV 3 (De-energized) or HBA 1 (De-energized)	EV 1 (De-energized) or EV 2 (De-energized)	De-energized alarm corresponding to two loops control
7	MV 1	MV 2	EV 3 (Energized), EV 4 (Energized), HBA 1 (Energized) or HBA 2 (Energized)	EV 2 (Energized)	EV 1 (Energized)	Energized alarm corresponding to two loops control
8	MV 1	MV 2	EV 3 (De-energized), EV 4 (De-energized), HBA 1 (De-energized) or HBA 2 (De-energized)	EV 2 (De-energized)	EV 1 (De-energized)	De-energized alarm corresponding to two loops control
9	MV 1 (OPEN)	MV 1 (CLOSE)	EV 3 (Energized), EV 4 (Energized), HBA 1 (Energized) or HBA 2 (Energized)	EV 2 (Energized)	EV 1 (Energized)	Energized alarm corresponding to position proportioning PID control
10	MV 1 (OPEN)	MV 1 (CLOSE)	EV 3 (De-energized), EV 4 (De-energized), HBA 1 (De-energized) or HBA 2 (De-energized)	EV 2 (De-energized)	EV 1 (De-energized)	De-energized alarm corresponding to position proportioning PID control
11	MV 1	EV 4 (Energized) or HBA 2 (Energized)	EV 3 (Energized) or HBA 1 (Energized)	EV 2 (Energized)	EV 1 (Energized)	Energized alarm

MV 1 = Manipulated output value of Input 1,

MV 2 = Manipulated output value of Input 2,

MV 1 (OPEN) = Open-side control output of Position proportioning PID control,

MV 1 (CLOSE) = Close-side control output of Position proportioning PID control,

HBA 1 = Output of Heater break alarm 1,

HBA 2 = Output of Heater break alarm 2,

EV 1 = Output of Event 1, EV 2 = Output of Event 2, EV 3 = Output of Event 3, EV 4 = Output of Event 4, FAIL = FAIL output

Continued on the next page.

Continued from the previous page.



An output logic becomes *OR* output when two or more output functions are assigned to one output.



When three transmission outputs are selected, the transmission outputs are automatically assigned to OUT1 through OUT3 and it has priority over the Output logic selection.

To select Manipulated output value of Input 1 or Input 2 as output type of OUT1, OUT2 or OUT3, select “4: Input 1_manipulated output value (MV)” or “8: Input 2_manipulated output value (MV)” at the parameters of Transmission output type selection.

Transmission output type	Assign location of output
Transmission output 1	Output 1 (OUT1)
Transmission output 2	Output 2 (OUT2)
Transmission output 3	Output 3 (OUT3)

Factory set value: For 1-input controller: 1
For 2-input controller: 5

Related parameters: Output timer setting (P. 99), Transmission output type selection (P. 101),
Event input logic selection (P. 94), CT assignment (P. 113),
Heater break alarm (HBA) type selection (P. 141),
Alarm lamp lighting condition setting (P. 143, P. 144)

Output 1 timer setting	Data register area for static data read (Byte)	No assignment
	Function number for dynamic data request	80H (128)
Output 2 timer setting	Data register area for static data read (Byte)	No assignment
	Function number for dynamic data request	81H (129)
Output 3 timer setting	Data register area for static data read (Byte)	No assignment
	Function number for dynamic data request	82H (130)
Output 4 timer setting	Data register area for static data read (Byte)	No assignment
	Function number for dynamic data request	83H (131)
Output 5 timer setting	Data register area for static data read (Byte)	No assignment
	Function number for dynamic data request	84H (132)

Output timer setting is to set an output delay time for event outputs.

Attribute: R/W (Read and Write)



This item becomes RO (Read only) during control RUN.

Data range: 0.0 to 600.0 seconds

Factory set value: 0.0

Related parameters: Output logic selection (P. 97), Event type selection (P. 104),
Alarm lamp lighting condition setting (P. 143, P. 144)

Output Timer Setting function:

Refer to the next page.

Continued on the next page.

Continued from the previous page.

When an event condition becomes On status, the output is suppressed until the Output Timer set time elapses. After the time is up, if the event output is still ON status, the output will be produced.

Example: When set the event timer to 100.0 seconds.

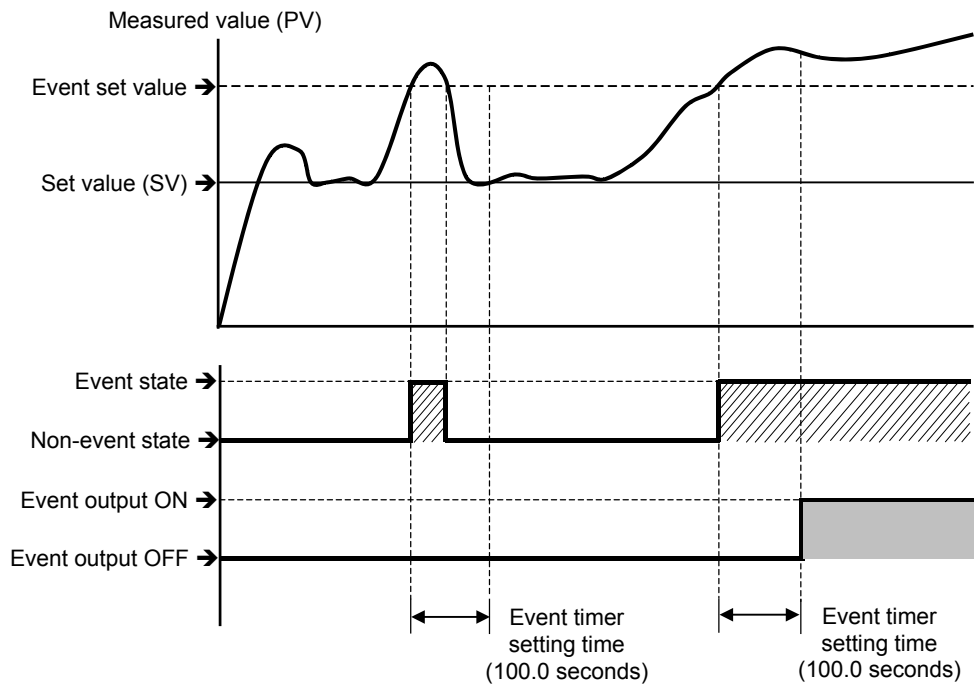

Transmission output 1 _ type selection	Data register area for static data read (Byte)	No assignment
	Function number for dynamic data request	85H (133)
Transmission output 2_ type selection	Data register area for static data read (Byte)	No assignment
	Function number for dynamic data request	88H (136)
Transmission output 3_ type selection	Data register area for static data read (Byte)	No assignment
	Function number for dynamic data request	8BH (139)

Use to select the transmission output type.

Attribute: R/W (Read and Write)



This item becomes RO (Read only) during control RUN.

Data range: 0: None
 1: Input 1_measured value (PV)
 2: Input 1_set value (SV)
 3: Input 1_deviation value
 4: Input 1_manipulated output value (MV)
 5: Input 2_measured value (PV)
 6: Input 2_set value (SV)
 7: Input 2_deviation value
 8: Input 2_manipulated output value (MV)
 9: Feedback resistance input value (POS)

Factory set value: 0

Related parameters: Transmission output scale high (P. 102),
 Transmission output scale low (P. 103)



Specify the output type of the transmission output when ordering.



When transmission outputs are selected and used, the outputs are allocated as follows.

- Transmission output 1: Output 1 (OUT1)
- Transmission output 2: Output 2 (OUT2)
- Transmission output 3: Output 3 (OUT3)



The transmission has priority over the Output logic selection.

Transmission output 1_scale high	Data register area for static data read (Byte)	No assignment
	Function number for dynamic data request	86H (134)
Transmission output 2_scale high	Data register area for static data read (Byte)	No assignment
	Function number for dynamic data request	89H (137)
Transmission output 3_scale high	Data register area for static data read (Byte)	No assignment
	Function number for dynamic data request	8CH (140)

Use to set a scale high limit value of the transmission output.

Attribute: R/W (Read and Write)



This item becomes RO (Read only) during control RUN.

Data range: Measured value (PV) and Set value (SV): Input scale low to Input scale high
 Manipulated output value (MV) and Feedback resistance input value (POS):
 -5.0 to +105.0 %

Deviation value: -Input span to +Input span

Factory set value: Measured value (PV) and Set value (SV): Input scale high
 Manipulated output value (MV) and Feedback resistance input value (POS):
 100.0

Deviation value: + Input span

Related parameters: Transmission output type selection (P. 101),
 Transmission output scale low (P. 103)

Transmission output 1_scale low	Data register area for static data read (Byte)	No assignment
	Function number for dynamic data request	87H (135)
Transmission output 2_scale low	Data register area for static data read (Byte)	No assignment
	Function number for dynamic data request	8AH (138)
Transmission output 3_scale low	Data register area for static data read (Byte)	No assignment
	Function number for dynamic data request	8DH (141)

Use to set a scale low limit value of the transmission output.

Attribute: R/W (Read and Write)



This item becomes RO (Read only) during control RUN.

Data range: Measured value (PV) and Set value (SV): Input scale low to Input scale high
 Manipulated output value (MV) and Feedback resistance input value (POS):

–5.0 to +105.0 %

Deviation value: –Input span to +Input span

Factory set value: Measured value (PV) and Set value (SV): Input scale low
 Manipulated output value (MV) and Feedback resistance input value (POS):

0.0

Deviation value: –Input span

Related parameters: Transmission output type selection (P. 101),
 Transmission output scale high (P. 102)

Event 1 type selection	Data register area for static data read (Byte)	No assignment
	Function number for dynamic data request	8EH (142)
Event 2 type selection	Data register area for static data read (Byte)	No assignment
	Function number for dynamic data request	93H (147)
Event 3 type selection	Data register area for static data read (Byte)	No assignment
	Function number for dynamic data request	98H (152)
Event 4 type selection	Data register area for static data read (Byte)	No assignment
	Function number for dynamic data request	9DH (157)

Use to select a type of the Event 1, 2, 3 and 4.

Attribute: R/W (Read and Write)



This item becomes RO (Read only) during control RUN.

Data range:

- 0: None
- 1: Deviation high ¹
- 2: Deviation low ¹
- 3: Deviation high/low ¹
- 4: Band ¹
- 5: Process high ¹
- 6: Process low ¹
- 7: SV high
- 8: SV low
- 9: Control loop break alarm (LBA) ²

¹ Event hold action is available.

² The "9: Control loop break alarm (LBA)" can be selected only for Event 3 and Event 4.

Factory set value: 0

Related parameters: Event set value (P. 62), Control loop break alarm (LBA) time (P. 63), LBA deadband (P. 63), Output logic selection (P. 97), Output timer setting (P. 99), Event hold action (P. 106), Event differential gap (P. 108), Event action at input error (P. 110), Event assignment (P. 111), Alarm lamp lighting condition setting (P. 143, P. 144)

Functional description:

Refer to the next page.

Continued on the next page.

Continued from the previous page.

● Event action type

Deviation high:

(Event set value is greater than 0.)

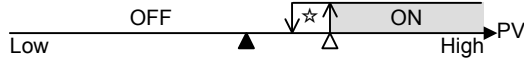

(▲ : Set value (SV) Δ : Event set value ☆ : Event differential gap)

(Event set value is less than 0.)



Deviation low:

(Event set value is greater than 0.)



(Event set value is less than 0.)

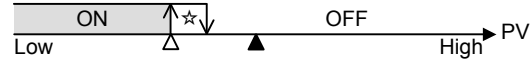

Deviation high/low:



Band:



Process high:

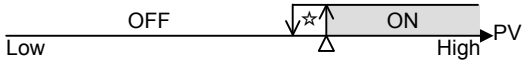

Process low:

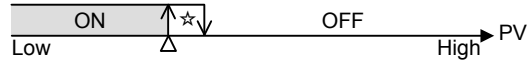

SV high:

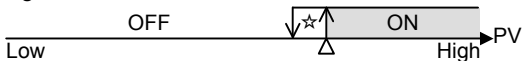

SV low:

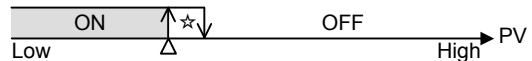

● Control loop break alarm (LBA)

The control loop break alarm (LBA) function is used to detect a load (heater) break or a failure in the external actuator (power controller, magnet relay, etc.), or a failure in the control loop caused by an input (sensor) break. The LBA function is activated when control output reaches 0 % (low limit with output limit function) or 100 % (high limit with output limit function). LBA monitors variation of the Measured value (PV) for the length of LBA time. When the LBA time has elapsed and the PV is still within the alarm determination range, the LBA will be ON.

[Alarm action]

The LBA function produces the alarm when any of the following conditions occurs.

LBA determination range: Temperature input: 2 °C [2 °F] (fixed)

Voltage/Current input: 0.2 % of span (fixed)

● When the control output reaches 0 % (low limit with output limit function)

For direct action: When the LBA time has passed and the PV has not risen beyond the alarm determination range, the alarm will be turned on.

For reverse action: When the LBA time has passed and the PV has not fallen below the alarm determination range, the alarm will be turned on.

● When the output exceeds 100 % (low limit with output high function)

For direct action: When the LBA time has passed and the PV has not fallen below the alarm determination range, the alarm will be turned on.

For reverse action: When the LBA time has passed and the PV has not risen beyond the alarm determination range, the alarm will be turned on.



If the Autotuning function is used, the LBA time is automatically set twice as large as the integral time. The LBA setting time will not be changed even if the integral time is changed.

Continued on the next page.

Continued from the previous page.



LBA function is not operative when:

- AT function is activated.
- The controller is in STOP mode.
- LBA function is set to “0.”
- LBA function is not assigned to Event 3 or Event 4.



The LBA function does not detect a location which causes alarm status. If LBA alarm is ON, check each device or wiring of the control loop.



While the LBA is ON (under alarm status), the following conditions cancel the alarm status and LBA will be OFF:

- The Measured value (PV) rises beyond (or falls below) the LBA determination range within the LBA time.
- The Measured value (PV) enters within the LBA deadband.

Event 1 hold action	Data register area for static data read (Byte)	No assignment
	Function number for dynamic data request	8FH (143)
Event 2 hold action	Data register area for static data read (Byte)	No assignment
	Function number for dynamic data request	94H (148)
Event 3 hold action	Data register area for static data read (Byte)	No assignment
	Function number for dynamic data request	99H (153)
Event 4 hold action	Data register area for static data read (Byte)	No assignment
	Function number for dynamic data request	9EH (158)

Use to set a event hold action for the Event 1, 2, 3 or 4.



When high alarm with Hold/Re-hold action is used for Event function, alarm does not turn on while Hold action is in operation. Use in combination with a high alarm without Hold action in order to prevent overheating which may occur by failure of control devices, such as welding of relays.

Attribute: R/W (Read and Write)



This item becomes RO (Read only) during control RUN.

Data range: 0: OFF
1: ON
2: Re-hold action ON

Factory set value: 0

Continued on the next page.

Continued from the previous page.

Related parameters: Event set value (P. 62), Event type selection (P. 104),
Event differential gap (P. 108), Event action at input error (P. 110),
Event assignment (P. 111)

Functional description:

● Hold action

When Hold action is ON, the event action is suppressed at start-up or STOP to RUN until the measured value has entered the non-event range.

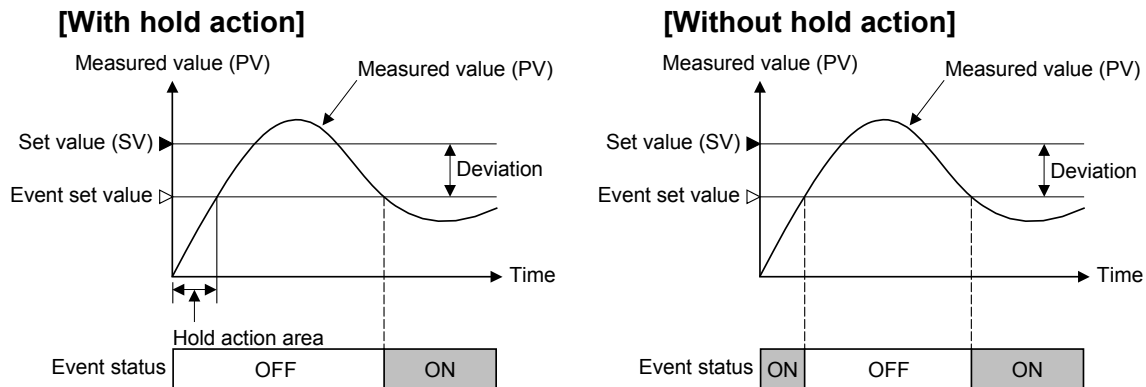

● Re-hold action

When Re-hold action is ON, the event action is also suppressed at the control set value change until the measured value has entered the non-event range.

Action condition	1: Hold action ON (Only Hold action)	2: Re-hold action ON (Hold and Re-hold actions)
When the power is turned on	Hold action	Hold action
When transferred from STOP (control STOP) to RUN (control RUN)	Hold action	Hold action
When the Set value (SV) is changed	Without Hold and Re-hold actions	Re-hold action



The Re-hold action is invalidated for any of the following. However, the Hold action is validated.

- When Setting change rate limiter other than “OFF (Unused)” are set
- When Remote/Local transfer is the remote mode

[Example] When Event 1 type is the deviation low:

When Re-hold action is OFF and event output type is deviation, the event output is produced due to the Set value change. The Re-hold action suppresses the alarm output until the measured value has entered the non-event range again.

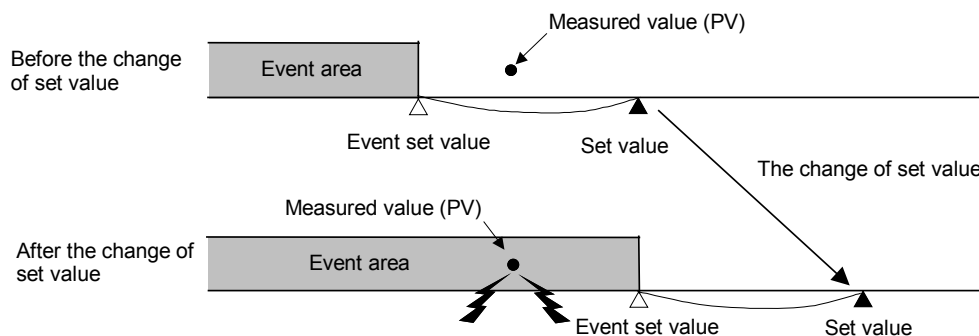

Event 1 differential gap	Data register area for static data read (Byte)	No assignment
	Function number for dynamic data request	90H (144)
Event 2 differential gap	Data register area for static data read (Byte)	No assignment
	Function number for dynamic data request	95H (149)
Event 3 differential gap	Data register area for static data read (Byte)	No assignment
	Function number for dynamic data request	9AH (154)
Event 4 differential gap	Data register area for static data read (Byte)	No assignment
	Function number for dynamic data request	9FH (159)

Use to set a differential gap of the Event 1, 2, 3 or 4.

Attribute: R/W (Read and Write)



This item becomes RO (Read only) during control RUN.

Data range: 0 to Input span
(Varies with the setting of the Decimal point position)

Factory set value: Thermocouple (TC) /RTD inputs: 2.0 °C [°F]
Voltage (V)/Current (I) inputs: 0.2 % of input span

Related parameters: Event set value (P. 62), Event type selection (P. 104),
Event hold action (P. 106), Event action at input error (P. 110),
Event assignment (P. 111)

Event differential gap function:
Refer to the next page.

Continued on the next page.

Continued from the previous page.

It prevents chattering of event output due to the measured value fluctuation around the event set value.

[Event high]

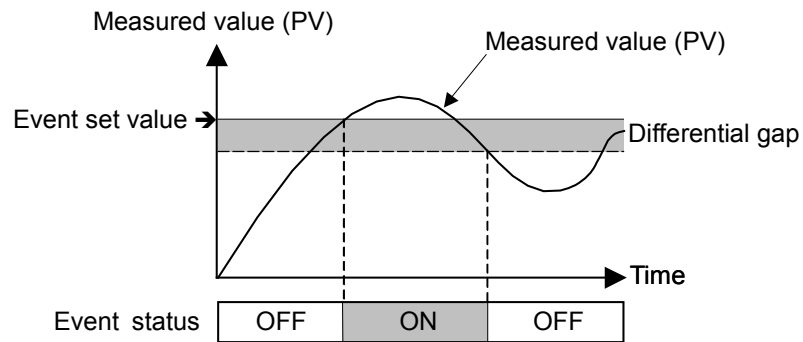

[Event low]

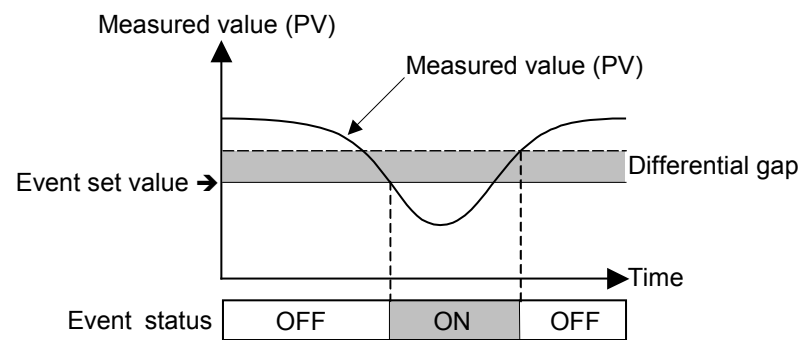

Event 1 action at input error	Data register area for static data read (Byte)	No assignment
	Function number for dynamic data request	91H (145)
Event 2 action at input error	Data register area for static data read (Byte)	No assignment
	Function number for dynamic data request	96H (150)
Event 3 action at input error	Data register area for static data read (Byte)	No assignment
	Function number for dynamic data request	9BH (155)
Event 4 action at input error	Data register area for static data read (Byte)	No assignment
	Function number for dynamic data request	A0H (160)

Event action at input error is to select the event action when the measured value reaches the input error determination point (high or low limit).

Attribute: R/W (Read and Write)

 **This item becomes RO (Read only) during control RUN.**

Data range: 0: Normal processing
1: Turn the event output ON

Factory set value: 0

Related parameters: Input error determination point (high) (P. 91),
Input error determination point (low) (P. 92)

Event action at input error:

Example: Input range: 0 to 400 °C
Input error determination point (high): 300 °C
Input error determination point (low): 50 °C

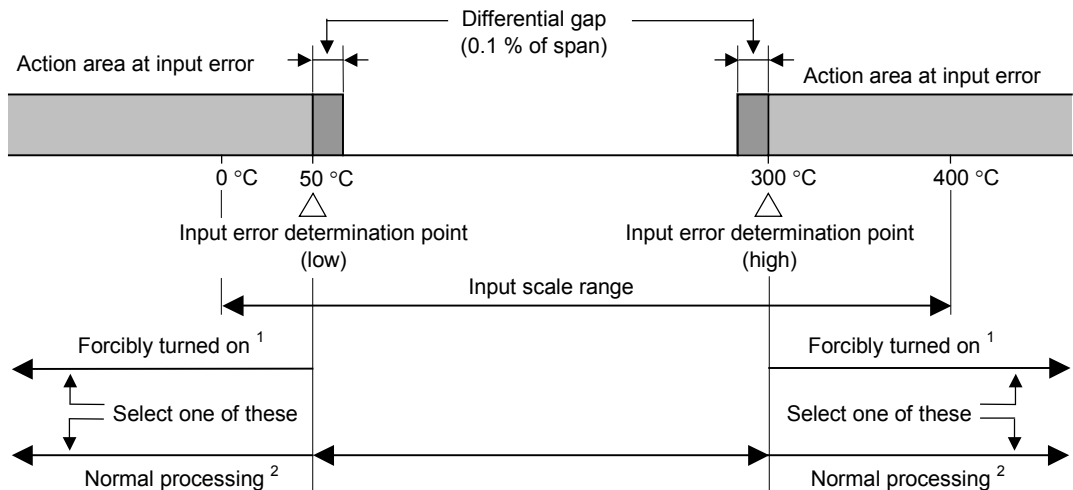

¹ The event output is forcibly turned on regardless of the selected event action status when the input is abnormal.

² The event output is produced depending on the selected event action status even if the input is abnormal.

Event 1 assignment	Data register area for static data read (Byte)	No assignment
	Function number for dynamic data request	92H (146)
Event 2 assignment	Data register area for static data read (Byte)	No assignment
	Function number for dynamic data request	97H (151)
Event 3 assignment	Data register area for static data read (Byte)	No assignment
	Function number for dynamic data request	9CH (156)
Event 4 assignment	Data register area for static data read (Byte)	No assignment
	Function number for dynamic data request	A1H (161)

Use to assign event outputs to either Input 1 or Input 2.

Attribute: R/W (Read and Write)



This item becomes RO (Read only) during control RUN.

Data range: 1: For input 1
2: For input 2

Factory set value: 1

Related parameters: Event set value (P. 62), Event type selection (P. 104),
Event hold action (P. 106), Event differential gap (P. 108),
Event action at input error (P. 110)

CT1 ratio	Data register area for static data read (Byte)	No assignment
	Function number for dynamic data request	A2H (162)
CT2 ratio	Data register area for static data read (Byte)	No assignment
	Function number for dynamic data request	A4H (164)

Use to set the number of turns in the current transformer which is used to monitor the current flowing through the load. There are two types of dedicated current transformers.

Attribute: R/W (Read and Write)



This item becomes RO (Read only) during control RUN.

Data range: 0 to 9999

Factory set value: When the CT type is CTL-6-P-N: 800
When the CT type is CTL-12-S56-10L-N: 1000

Related parameters: Heater break alarm (HBA) set value (P. 73), CT assignment (P. 113)
Heater break determination point (P. 81),
Heater melting determination point (P. 82)

CT1 assignment	Data register area for static data read (Byte)	No assignment
	Function number for dynamic data request	A3H (163)
CT2 assignment	Data register area for static data read (Byte)	No assignment
	Function number for dynamic data request	A5H (165)

Use to assign the current transformer input to an output from OUT1 to OUT5. The CT input 1 is tied to HBA1, and the CT input 2 tied to HBA2, so when CT1 is assigned to OUT1, HBA1 is also automatically assigned to OUT1.

Attribute: R/W (Read and Write)



This item becomes RO (Read only) during control RUN.

Data range: 0: None
 1: Output 1 (OUT1)
 2: Output 2 (OUT2)
 3: Output 3 (OUT3)
 4: Output 4 (OUT4)
 5: Output 5 (OUT5)

Factory set value: **CT1 for:**
 Current transformer 1 (CT1) input not provided: 0
 Current transformer 1 (CT1) input provided: 1 (When HBA1 is specified)
CT2 for:
 Current transformer 2 (CT2) input not provided: 0
 Current transformer 2 (CT2) input provided: 2 (When HBA2 is specified)

Related parameters: Heater break alarm (HBA) set value (P. 73), Output logic selection (P. 97), CT ratio (P. 112)



The current transformer 1 (CT1) is for the heater break alarm 1 (HBA1). The current transformer 2 (CT2) is for the heater break alarm 2 (HBA2). Select an appropriate output number by checking the Output Logic Selection or Transmission Output Type.



To use HBA for a three-phase load, both CT inputs can be assigned to the same output.

Hot/Cold start selection	Data register area for static data read (Byte)	No assignment
	Function number for dynamic data request	A6H (166)

Use to select the start mode at power recovery.

Attribute: R/W (Read and Write)



This item becomes RO (Read only) during control RUN.

Data range: 0 to 5 (refer to the following table)

Set value	Power failure less than 3 seconds	Power failure 3 seconds or more
0	Hot start 1	Hot start 1
1	Hot start 1	Hot start 2
2	Hot start 1	Cold start
3	Hot start 2	Hot start 2
4	Hot start 2	Cold start
5	Cold start	Cold start
6	Hot start 1	Stop start
7	Hot start 2	Stop start
8	Stop start	Stop start

Factory set value: 0

Hot/Cold start function:

After the power failure, when power is back to the controller,

Hot start 1: the controller will return to the same operation mode and the same manipulated value which were used or calculated by the controller before power failure.

Hot start 2: the controller will return to the same operation mode which was used by the controller before power failure.

- In the Manual mode, the output value will be at the low output limit value.
- In the Auto mode, the controller will calculate the manipulated output value regardless that before power failure. So, the manipulated output varies.

Cold start: the controller will automatically go to Manual mode and output the low output limit value.

Stop start: Started in the control stop (STOP) state regardless of the RUN mode (Auto/Manual) before power failure. Set to the RUN mode before power failure when changed to RUN from STOP by RUN/STOP selection.

Input 2_use selection	Data register area for static data read (Byte)	No assignment
	Function number for dynamic data request	A7H (167)

Use to select the usage of Input 2. Cascade control can be selected by this parameter.

Attribute: R/W (Read and Write)



This item becomes RO (Read only) during control RUN.

Data range: 0: Single loop control
1: Remote input
2: Cascade control (Slave)

Factory set value: 0

Cascade ratio	Data register area for static data read (Byte)	No assignment
	Function number for dynamic data request	A8H (168)

Cascade ratio is a multiplier which is used to convert the manipulated output (%) to cascade signal (°C or °F) at the cascade master.

Attribute: R/W (Read and Write)



This item becomes RO (Read only) during control RUN.

Data range: 0.0000 to 1.5000

Factory set value: 1.0000

Related parameters: Cascade bias (P. 115)

Cascade bias	Data register area for static data read (Byte)	No assignment
	Function number for dynamic data request	A9H (169)

The cascade bias is applied to the input value on the slave side in the cascade control.

Attribute: R/W (Read and Write)



This item becomes RO (Read only) during control RUN.

Data range: -Input span to +Input span

Factory set value: 0

Continued on the next page.

Continued from the previous page.

 The functional description of relative items to the cascade control is shown in the following.

● **Cascade control**

Cascade control monitors the controlled object temperature in the master unit and then corrects the set value in the slave unit depending on the deviation between the target value (set value) and actual temperature. The slave unit controls the non-controlled object (heater, refrigeration device, etc). As a result, the controlled object temperature can be reached and controlled at the target value. Cascade control is suitable for an application which has a large time lag between the heat/refrigeration source and section whose temperature is necessary to be controlled.

● **Cascade ratio**

The conversion rate when the manipulated output (%) in the cascade master is converted to the relevant cascade signal (°C or °F) can be changed from 0.0000 to 1.5000 by the cascade ratio.

● **Cascade bias**

The cascade bias is a bias added to the input value on the slave side.

Example: Relationship between the manipulated output (%) in the cascade master and relevant cascade signal (°C)

Output scale in the input 1 (master): 0 to 100 %
 Input scale in the input 2: -100 to +400 °C

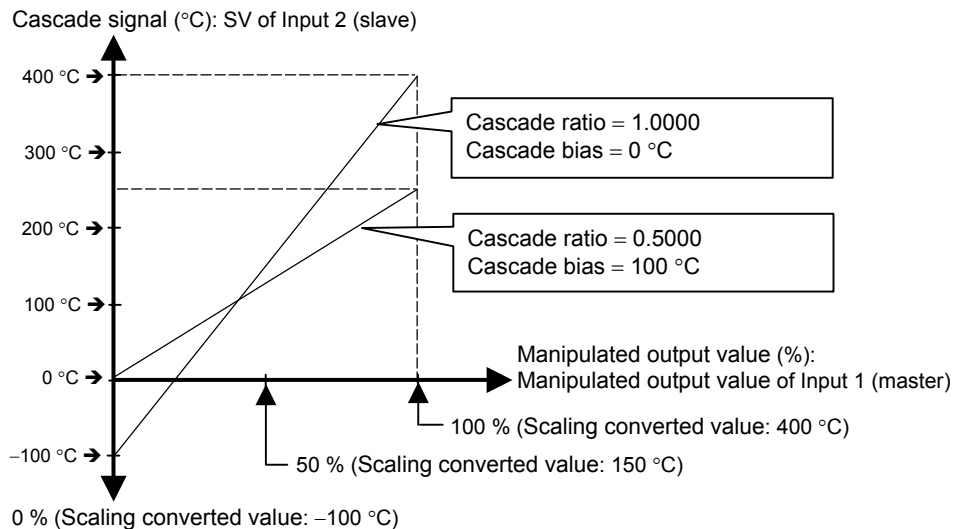
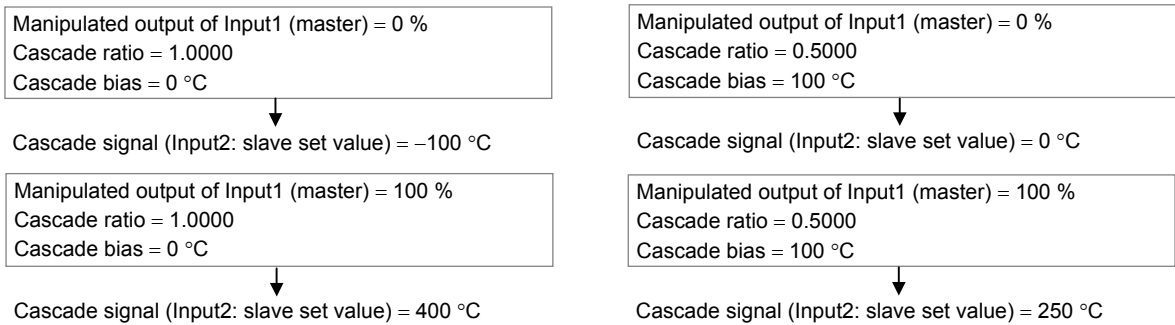

SV tracking	Data register area for static data read (Byte)	No assignment
	Function number for dynamic data request	AAH (170)

To select Use/Unuse of SV tracking.

Attribute: R/W (Read and Write)



This item becomes RO (Read only) during control RUN.

Data range: 0: Unused
1: Used

Factory set value: 1

SV Tracking function:

With SV Tracking function, when Remote/Local mode is transferred from Remote to Local, the set value used in Remote mode before the mode transfer will be kept using in Local mode to prevent rapid set value change.

Operation mode:	Local	→	Remote	→	Local
Set value used	Local set value		Remote set value		Local set value
SV tracking used	Local set value \neq Remote set value		Local set value = Remote set value		Local set value = Remote set value
SV tracking unused	Local set value \neq Remote set value		Local set value \neq Remote set value		Local set value \neq Remote set value

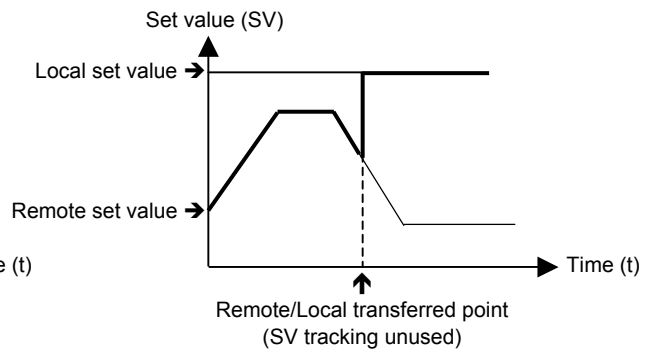
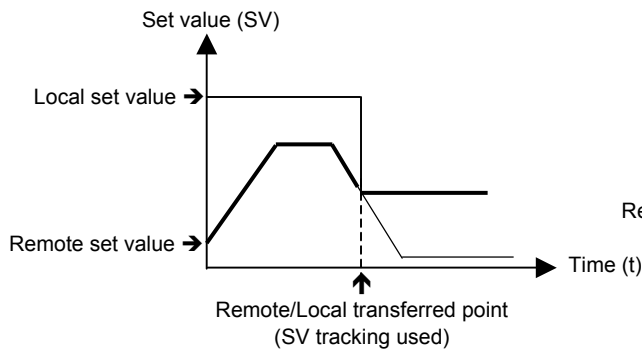

Input 1_control action type selection	Data register area for static data read (Byte)	No assignment
	Function number for dynamic data request	ABH (171)
Input 2_control action type selection	Data register area for static data read (Byte)	No assignment
	Function number for dynamic data request	B8H (184)

Use to select direct action/reverse action.

Attribute: R/W (Read and Write)

 **This item becomes RO (Read only) during control RUN.**

Data range: 0: Direct action
1: Reverse action

Factory set value: Input 1_control action type selection: 1
Input 2_control action type selection: 1

Control action type:

Direct action: The Manipulated output value (MV) increases as the Measured value (PV) increases. This action is used generally for cool control.

Reverse action: The Manipulated output value (MV) decreases as the Measured value (PV) increases. This action is used generally for heat control.

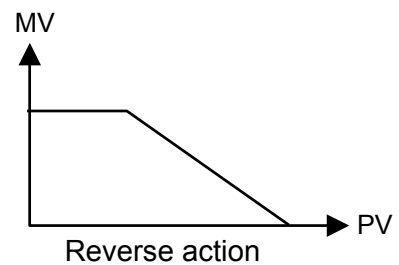
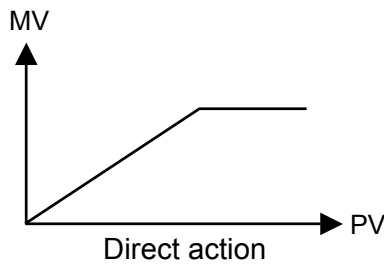

Input 1_integral/derivative time decimal point position selection	Data register area for static data read (Byte)	No assignment
	Function number for dynamic data request	ACH (172)
Input 2_integral/derivative time decimal point position selection	Data register area for static data read (Byte)	No assignment
	Function number for dynamic data request	B9H (185)

Use to select a decimal point position of integral time and derivative time in PID control.

Attribute: R/W (Read and Write)



This item becomes RO (Read only) during control RUN.

Data range: 0: No decimal place
1: One decimal place
2: Two decimal places

Factory set value: Input 1_integral/derivative time decimal point position selection: 2
Input 2_integral/derivative time decimal point position selection: 2

Related parameters: Integral time (P. 67), Derivative time (P. 67)

Input 1_derivative gain	Data register area for static data read (Byte)	No assignment
	Function number for dynamic data request	ADH (173)
Input 2_derivative gain	Data register area for static data read (Byte)	No assignment
	Function number for dynamic data request	BAH (186)

Use to set a gain used for derivative action in PID control. Derivative gain should not be changed under ordinary operation.

Attribute: R/W (Read and Write)



This item becomes RO (Read only) during control RUN.

Data range: 0.1 to 10.0

Factory set value: Input 1_derivative gain: 6.0
Input 2_derivative gain: 6.0



Under ordinary operation, it is not necessary to change Derivative gain set value.

Input 1_ON/OFF action differential gap (upper)	Data register area for static data read (Byte)	No assignment
	Function number for dynamic data request	AEH (174)
Input 2_ON/OFF action differential gap (upper)	Data register area for static data read (Byte)	No assignment
	Function number for dynamic data request	BBH (187)

Use to set the ON/OFF control differential gap (upper).

Attribute: R/W (Read and Write)



This item becomes RO (Read only) during control RUN.

Data range: 0 to Input span
(Varies with the setting of the Decimal point position)

Factory set value: Input 1_ON/OFF action differential gap (upper):
 Thermocouple (TC) /RTD inputs: 1.0 °C [°F]
 Voltage (V)/Current (I) inputs: 0.1 % of input span
 Input 2_ON/OFF action differential gap (upper):
 Thermocouple (TC) /RTD inputs: 1.0 °C [°F]
 Voltage (V)/Current (I) inputs: 0.1 % of input span

Related parameters: ON/OFF action differential gap (lower) (P. 121)

ON/OFF Action Differential Gap:

Refer to the ON/OFF action differential gap (lower).

Input 1_ON/OFF action differential gap (lower)	Data register area for static data read (Byte)	No assignment
	Function number for dynamic data request	AFH (175)
Input 2_ON/OFF action differential gap (lower)	Data register area for static data read (Byte)	No assignment
	Function number for dynamic data request	BCH (188)

Use to set the ON/OFF control differential gap (lower).

Attribute: R/W (Read and Write)



This item becomes RO (Read only) during control RUN.

Data range: 0 to Input span

(Varies with the setting of the Decimal point position)

Factory set value: Input 1_ON/OFF action differential gap (lower):

Thermocouple (TC) /RTD inputs: 1.0 °C [°F]

Voltage (V)/Current (I) inputs: 0.1 % of input span

Input 2_ON/OFF action differential gap (lower):

Thermocouple (TC) /RTD inputs: 1.0 °C [°F]

Voltage (V)/Current (I) inputs: 0.1 % of input span

Related parameters: ON/OFF action differential gap (upper) (P. 120)

ON/OFF Action Differential Gap:

ON/OFF control is possible when the proportional band is set to “0” or “0.0.”

In ON/OFF control with Reverse action, when the Measured value (PV) is smaller than the Set value (SV), the Manipulated output (MV) is 100 % or ON. When the PV is higher than the SV, the MV is 0 % or OFF. Differential gap setting prevents control output from repeating ON and OFF too frequently.

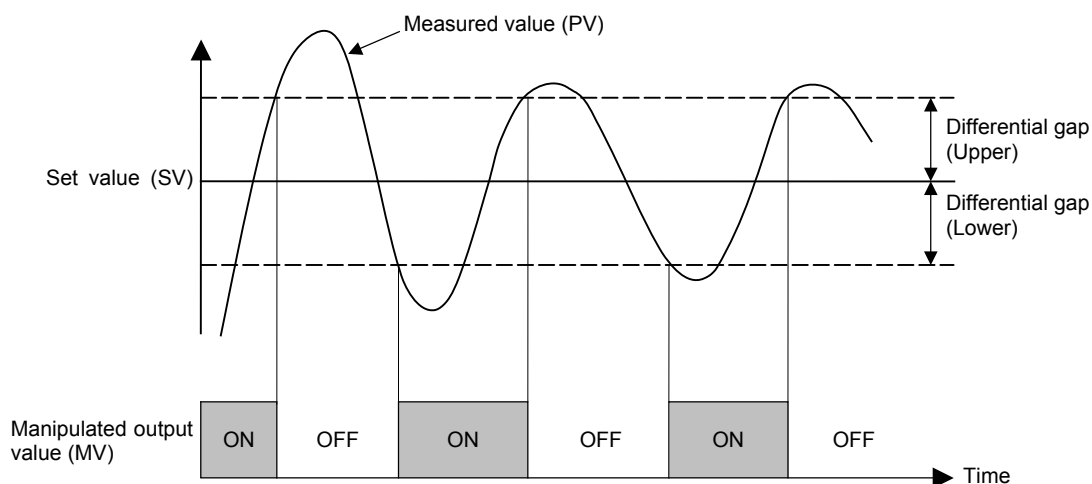

Input 1_action at input error (high)	Data register area for static data read (Byte)	No assignment
	Function number for dynamic data request	B0H (176)
Input 2_action at input error (high)	Data register area for static data read (Byte)	No assignment
	Function number for dynamic data request	BDH (189)

Use to select the action when the measured value reaches the Input error determination point (high) or more.

Attribute: R/W (Read and Write)

 **This item becomes RO (Read only) during control RUN.**

Data range: 0: Normal control
1: Manipulated Output Value at Input Error

Factory set value: Input 1_action at input error (high): 0
Input 2_action at input error (high): 0

Related parameters: Input error determination point (high) (P. 91),
Manipulated output value at input error (P. 123)

Input Error Determination:

Example: Input range: 0 to 400 °C
Input error determination point (high): 300 °C
Input error determination point (low): 50 °C

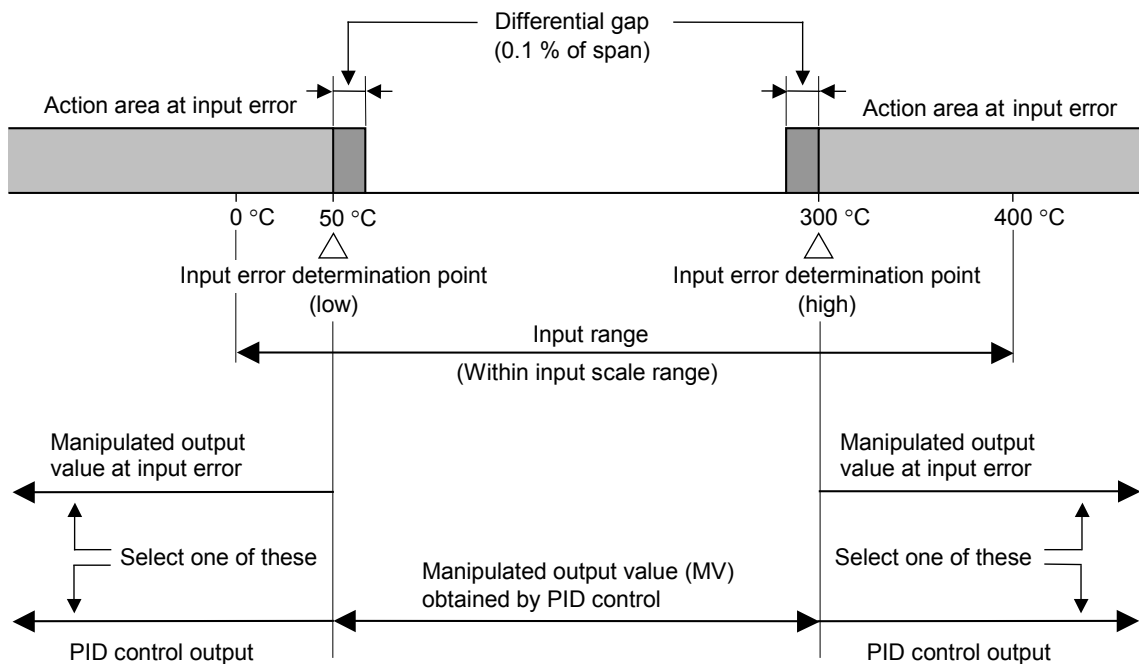

Input 1_action at input error (low)	Data register area for static data read (Byte)	No assignment
	Function number for dynamic data request	B1H (177)
Input 2_action at input error (low)	Data register area for static data read (Byte)	No assignment
	Function number for dynamic data request	BEH (190)

Use to select the action when the measured value reaches the Input error determination point (low).

Attribute: R/W (Read and Write)



This item becomes RO (Read only) during control RUN.

Data range: 0: Normal control
1: Manipulated Output Value at Input Error

Factory set value: Input 1_action at input error (low): 0
Input 2_action at input error (low): 0

Related parameters: Input error determination point (low) (P. 92),
Manipulated output value at input error (P. 123)

Input Error Determination:

Refer to the action at input error (high).

Input 1_manipulated output value at input error	Data register area for static data read (Byte)	No assignment
	Function number for dynamic data request	B2H (178)
Input 2_manipulated output value at input error	Data register area for static data read (Byte)	No assignment
	Function number for dynamic data request	BFH (191)

When the measured value reaches Input error determination point and Action at input error is set to "1," this manipulated value is output.

Attribute: R/W (Read and Write)



This item becomes RO (Read only) during control RUN.

Data range: -5.0 to +105.0 %

Factory set value: Input 1_manipulated output value at input error: -5.0
Input 2_manipulated output value at input error: -5.0

Related parameters: Input error determination point (high) (P. 91),
Input error determination point (low) (P. 92),
Action at input error (high) (P. 122),
Action at input error (low) (P. 123)

Input 1_output change rate limiter (up)	Data register area for static data read (Byte)	No assignment
	Function number for dynamic data request	B3H (179)
Input 2_output change rate limiter (up)	Data register area for static data read (Byte)	No assignment
	Function number for dynamic data request	C0H (192)

Use to set the output change rate limiter (upward side) to limit of the variation of output is set.

Attribute: R/W (Read and Write)



This item becomes RO (Read only) during control RUN.

Data range: 0.0 to 1000.0 %/second of manipulated output
0.0: OFF (Unused)

Factory set value: Input 1_output change rate limiter (up): 0.0
Input 2_output change rate limiter (up): 0.0

Related parameters: Output change rate limiter (down) (P. 124),
Output limiter high (P. 126), Output limiter low (P. 126)

Output Change Rate Limiter:

Refer to the next page.

Input 1_output change rate limiter (down)	Data register area for static data read (Byte)	No assignment
	Function number for dynamic data request	B4H (180)
Input 2_output change rate limiter (down)	Data register area for static data read (Byte)	No assignment
	Function number for dynamic data request	C1H (193)

Use to set the output change rate limiter (down).

Attribute: R/W (Read and Write)



This item becomes RO (Read only) during control RUN.

Data range: 0.0 to 1000.0 %/second of manipulated output
0.0: OFF (Unused)

Factory set value: Input 1_output change rate limiter (down): 0.0
Input 2_output change rate limiter (down): 0.0

Related parameters: Output change rate limiter (up) (P. 124),
Output limiter high (P. 126), Output limiter low (P. 126)

Output Change Rate Limiter:

Refer to the next page.

Continued on the next page.

Continued from the previous page.

Output change rate limiter:

The Output change rate limiter limits the variation of Manipulated output (MV) per second. This function is suitable for an application in which a sudden MV change is not acceptable.

[Example]

The output change rate limiter is effective

- The MV reaches 100 % when the power is turned on to the controller and such a sudden output change is not acceptable in the application.
- A sudden output change occurs at the SV change and it is not acceptable in the application.

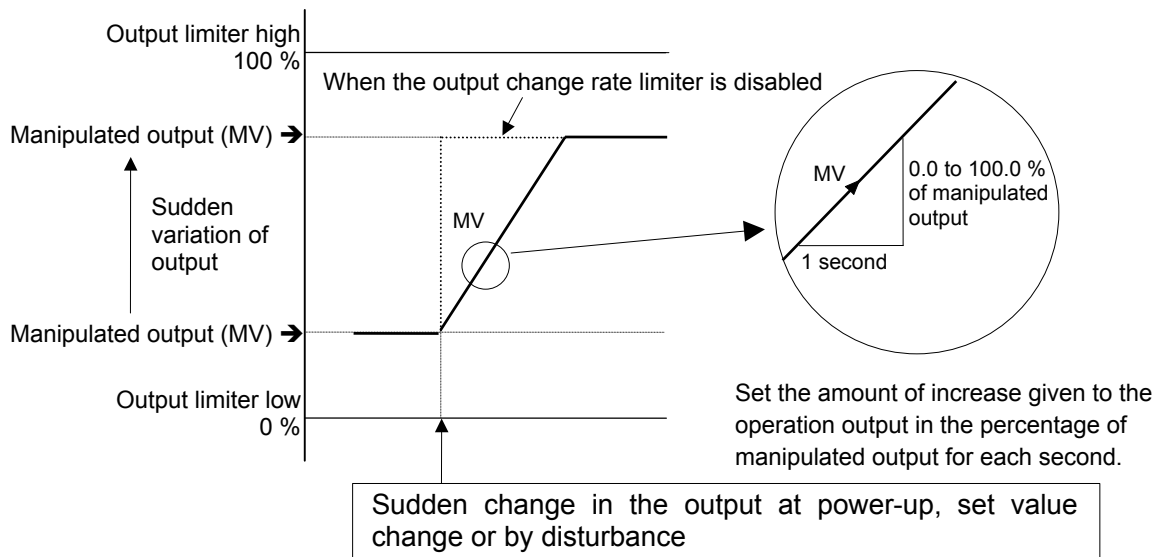

The output changes at specific rates set by Output change rate limiter (up) even under the situations where a sudden output change would occur without output change rate limiter function. There is also independent Output change rate limiter (down).



If the output change rate is set smaller, it will cause slow control response and affect Derivative action.



When the Output change rate limiter is used, you may not be able to obtain appropriate PID constants by Autotuning.



The Output change rate limiter is particularly effective when a sudden MV change may create uncontrollable situation cause a large current flow. Also, it is very effective current output or voltage output is used as control output.

Input 1_output limiter high	Data register area for static data read (Byte)	No assignment
	Function number for dynamic data request	B5H (181)
Input 2_output limiter high	Data register area for static data read (Byte)	No assignment
	Function number for dynamic data request	C2H (194)

Use to set the high limit value of manipulated output.

Attribute: R/W (Read and Write)



This item becomes RO (Read only) during control RUN.

Data range: Output limiter low to 105.0 %

Factory set value: Input 1_output limiter high: 105.0

Input 2_output limiter high: 105.0

Related parameters: Output change rate limiter (up) (P. 124),
Output change rate limiter (down) (P. 124),
Output limiter low (P. 126)

Input 1_output limiter low	Data register area for static data read (Byte)	No assignment
	Function number for dynamic data request	B6H (182)
Input 2_output limiter low	Data register area for static data read (Byte)	No assignment
	Function number for dynamic data request	C3H (195)

Use to set the low limit value of manipulated output.

Attribute: R/W (Read and Write)



This item becomes RO (Read only) during control RUN.

Data range: -5.0 % to Output limiter high

Factory set value: Input 1_output limiter low: -5.0

Input 2_output limiter low: -5.0

Related parameters: Output change rate limiter (up) (P. 124),
Output change rate limiter (down) (P. 124),
Output limiter high (P. 126)

Input 1_power feed forward selection	Data register area for static data read (Byte)	No assignment
	Function number for dynamic data request	B7H (183)
Input 2_power feed forward selection	Data register area for static data read (Byte)	No assignment
	Function number for dynamic data request	C4H (196)

Use to select Use/Unused of the power feed forward (PFF) function.

Attribute: R/W (Read and Write)

 **This item becomes RO (Read only) during control RUN.**

Data range: 0: Unused
1: Used

Factory set value: Input 1_power feed forward selection:
Based on the model code specified when ordered.
Input 2_power feed forward selection:
Based on the model code specified when ordered.

Related parameters: Power feed forward gain (P. 140)

Power Feed Forward function:

The power feed forward function monitors the electrical load through a dedicated transformer, and adjusts manipulated output to compensate power supply fluctuation. If the function detects approximately 30 % voltage drop, the controller automatically stops PID control.

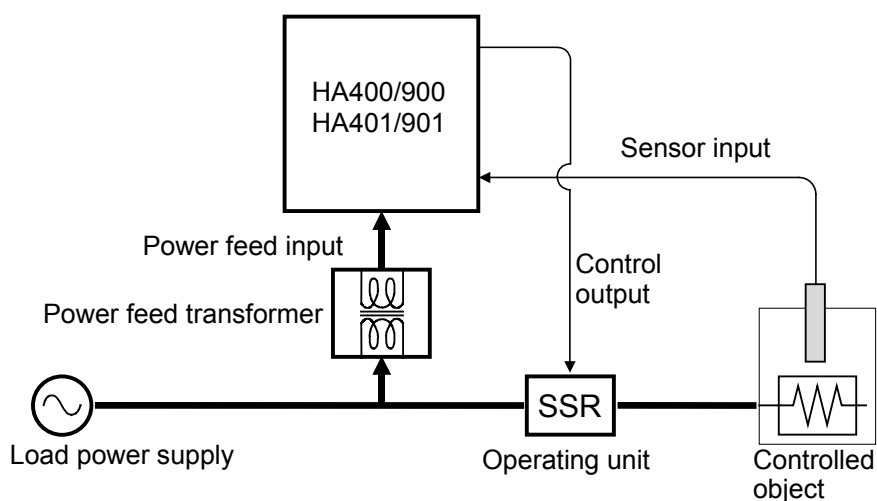

Continued on the next page.

Continued from the previous page.



The power feed forward function is used together with the output change rate limiter function, the manipulated output value may exceed the limit of the output change rate limiter.

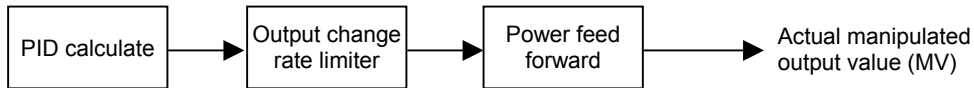

Relationship between the power feed forward and output change rate limiter



The controller with power feed forward function (optional) must be used with the dedicated power feed transformer. The controller will not output the Manipulated value (MV), if the transformer is not connected to the controller.



This parameter applies only to instruments specified with the power feed forward function (optional) when ordered.



When the power feed forward function is used for two-loop control, the power supply for controlled objects of both loops is required to be common.



Always use the dedicated power feed transformer included.

Input 1_AT bias	Data register area for static data read (Byte)	No assignment
	Function number for dynamic data request	C5H (197)
Input 2_AT bias	Data register area for static data read (Byte)	No assignment
	Function number for dynamic data request	C8H (200)

Use to set a bias to move the set value only when autotuning is activated.

Attribute: R/W (Read and Write)



This item becomes RO (Read only) during control RUN.

Data range: -Input span to +Input span

Factory set value: Input 1_AT bias: 0
Input 2_AT bias: 0

Related parameters: PID/AT transfer (P. 58)

Functional description:

The AT bias is used to prevent overshoot during autotuning in the application which does not allow overshoot even during autotuning. RKC autotuning method uses ON/OFF control at the set value to calculate the PID values. However, if overshoot is a concern during autotuning, the desired AT bias should be set to lower the set point during autotuning so that overshoot is prevented.

Example: When AT bias is set to the minus (-) side

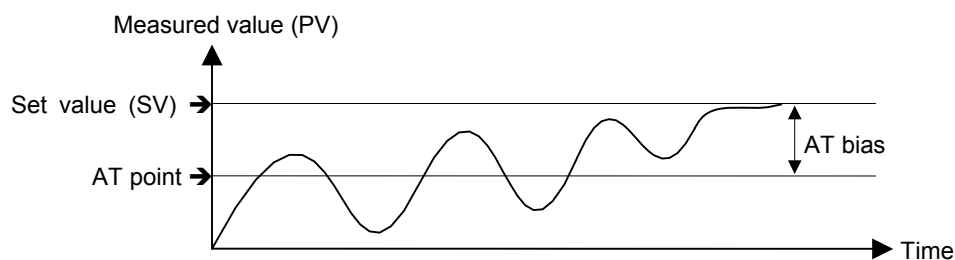

Input 1_AT cycle	Data register area for static data read (Byte)	No assignment
	Function number for dynamic data request	C6H (198)
Input 2_AT cycle	Data register area for static data read (Byte)	No assignment
	Function number for dynamic data request	C9H (201)

Use to select the number of ON/OFF cycles used to calculate PID values during autotuning.

Attribute: R/W (Read and Write)

 **This item becomes RO (Read only) during control RUN.**

Data range: 0: 1.5 cycles
 1: 2.0 cycles
 2: 2.5 cycles
 3: 3.0 cycles

Factory set value: Input 1_AT cycle: 1
 Input 2_AT cycle: 1

Related parameters: PID/AT transfer (P. 58)

Example: When the AT cycle is set to 1.5 cycle and the Autotuning (AT) function is executed just after the power is turned on.

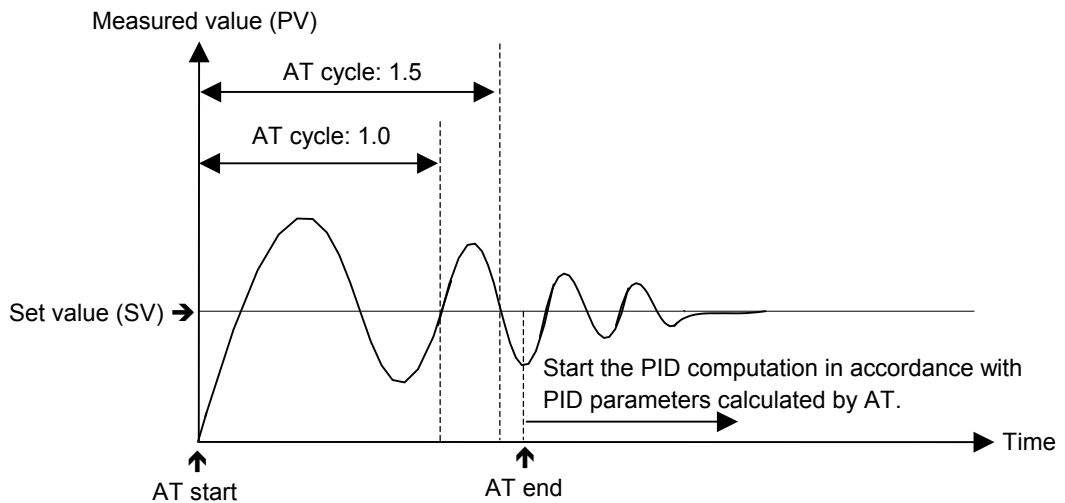

Input 1_AT differential gap time	Data register area for static data read (Byte)	No assignment
	Function number for dynamic data request	C7H (199)
Input 2_AT differential gap time	Data register area for static data read (Byte)	No assignment
	Function number for dynamic data request	CAH (202)

Use to set an ON/OFF action differential gap time for autotuning. This function prevents the AT function from malfunctioning caused by noise.

Attribute: R/W (Read and Write)



This item becomes RO (Read only) during control RUN.

Data range: 0.00 to 50.00 seconds

Factory set value: HA400/900: Input 1_AT differential gap time: 0.10
 Input 2_AT differential gap time: 0.10
 HA401/901: Input 1_AT differential gap time: 10.00
 Input 2_AT differential gap time: 10.00

Related parameters: PID/AT transfer (P. 58)

Functional description:

In order to prevent the output from chattering due to the fluctuation of a Measured value (PV) caused by noise during autotuning, the output on or off state is held until “AT differential gap time” has passed after the output on/off state is changed to the other. Set “AT differential gap time” to “1/100 × Time required for temperature rise.”

Continued on the next page.

Continued from the previous page.

Example:

A: AT cycle time when the AT differential gap time is set to 0.00 second

The output chatters due to the fluctuation of the Measured value (PV) caused by noise, and autotuning function is not able to monitor appropriate cycles to calculate suitable PID values.

B: AT cycle time when the AT differential gap time is set to “Time corresponding to 0.25 cycles.”

The fluctuation of a Measured value (PV) caused by noise is ignored and as a result autotuning function is able to monitor appropriate cycles to calculate suitable PID values.

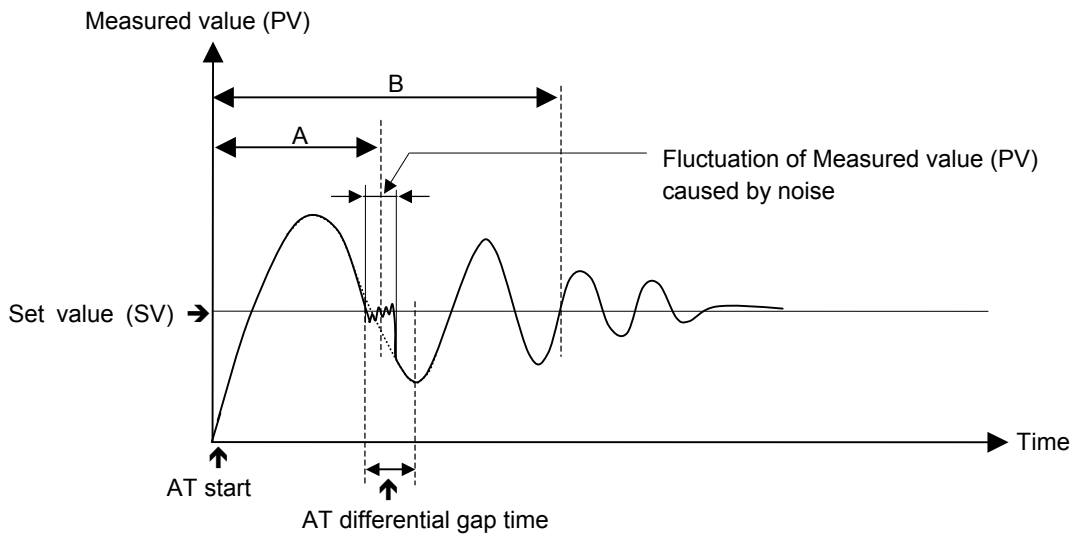

The factory set value of the AT cycle is 2 cycles.

Open/Close output neutral zone	Data register area for static data read (Byte)	No assignment
	Function number for dynamic data request	CBH (203)

Use to set Open/Close output neutral zone in position proportioning PID control.

Attribute: R/W (Read and Write)

 **This item becomes RO (Read only) during control RUN.**

Data range: 0.1 to 10.0 % of output

Factory set value: 10.0

Related parameters: Open/Close output differential gap (P. 134),
Action at feedback resistance (FBR) input error (P. 134),
Feedback adjustment (P. 135)

Open/Close Output Neutral Zone:

The neutral zone is used to prevent a control motor from repeating ON/OFF too frequently. When the PID calculated output value is within the neutral zone, the controller will not output the MV to a control motor.

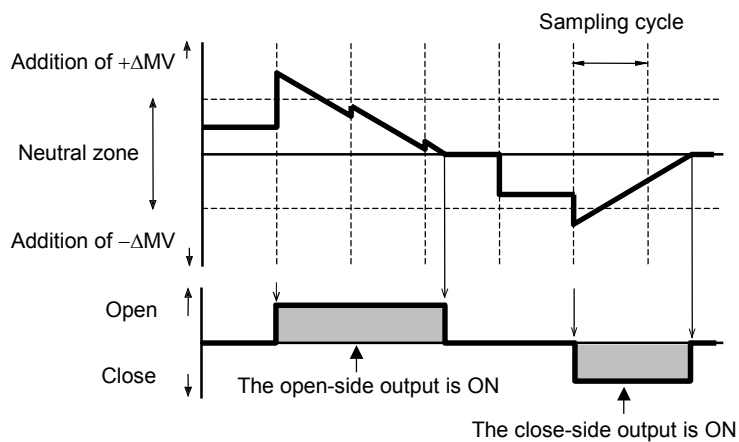

The controller does not output the MV to a control motor when the PID calculated output value is within the neutral zone.

Open/Close output differential gap	Data register area for static data read (Byte)	No assignment
	Function number for dynamic data request	CCH (204)

Use to set a differential gap of Open/Close output used in the position proportioning PID control.

Attribute: R/W (Read and Write)

 **This item becomes RO (Read only) during control RUN.**

Data range: 0.1 to 5.0 % of output

Factory set value: 0.2

Related parameters: Open/Close output neutral zone (P. 133),
Action at feedback resistance (FBR) input error (P. 134),
Feedback adjustment (P. 135)

Open/Close Output Differential Gap:

The Open/Close output differential gap prevents output ON/OFF chattering caused by fluctuation of feedback resistance input.

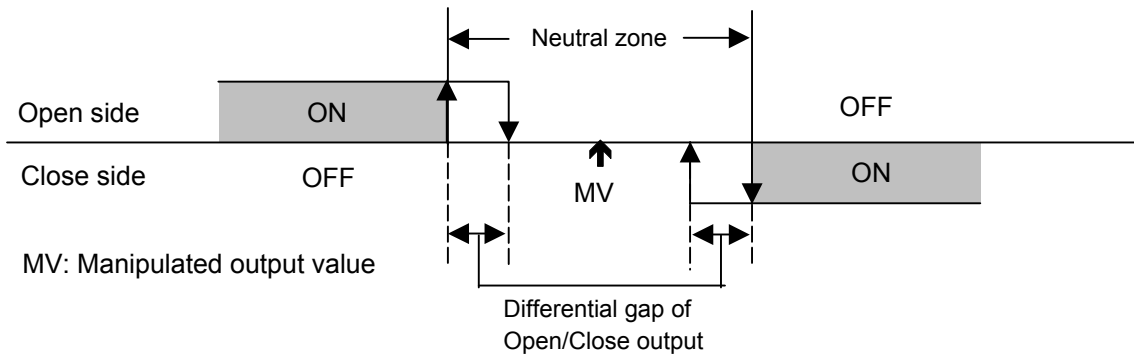

Action at feedback resistance (FBR) input error	Data register area for static data read (Byte)	No assignment
	Function number for dynamic data request	CDH (205)

Use to select an action at the feedback resistance (FBR) input break.

Attribute: R/W (Read and Write)

 **This item becomes RO (Read only) during control RUN.**

Data range: 0: Close-side output ON, Open-side output OFF
1: Close-side output OFF, Open-side output OFF
2: Close-side output OFF, Open-side output ON

Factory set value: 0

Related parameters: Open/Close output neutral zone (P. 133),
Open/Close output differential gap (P. 134), Feedback adjustment (P. 135)

Feedback adjustment	Data register area for static data read (Byte)	No assignment
	Function number for dynamic data request	CEH (206)

Feedback Adjustment function is to adjust controller's output value to match the feedback resistance (FBR) of the control motor. After the adjustment, the manipulated output value of 0 to 100 % obtained after PID computation matches the valve position signal of the fully closed position to the fully opened position [feedback resistance (FBR) input] sent from the control motor. The adjustment have to be completed before starting operation. Always make sure that the wiring is correct and the control motor operates normally before the adjustment.

Attribute: R/W (Read and Write)

 **This item becomes RO (Read only) during control RUN.**

Data range: 0: Adjustment end
1: During the Open-side adjusting
2: During the Close-side adjusting

Factory set value: —

Functional description:

The position proportioning PID control is performed by feeding back both the valve opening (feedback resistance input) from the control motor and Measured value (PV) from the controlled object in the flow control.

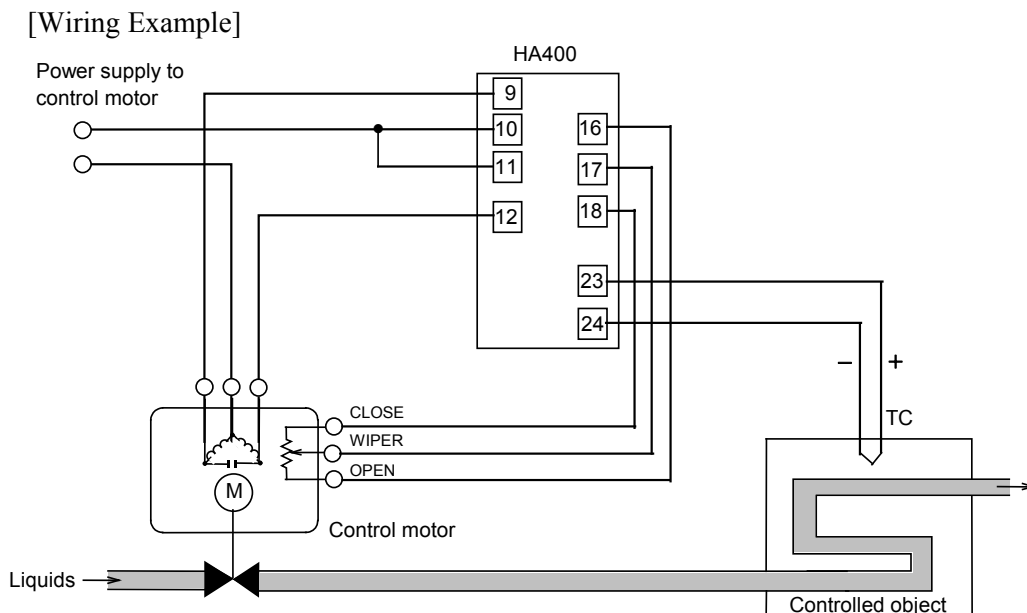

Setting change rate limiter unit time	Data register area for static data read (Byte)	No assignment
	Function number for dynamic data request	CFH (207)

Set the time unit for Setting change rate limiter (up/down).

Attribute: R/W (Read and Write)

 **This item becomes RO (Read only) during control RUN.**

Data range: 1 to 3600 seconds

Factory set value: 60

Related parameters: Setting change rate limiter (up/down) (P. 69)

Soak time unit selection	Data register area for static data read (Byte)	No assignment
	Function number for dynamic data request	D0H (208)

Use to select the time unit for Area soak time.

Attribute: R/W (Read and Write)

 **This item becomes RO (Read only) during control RUN.**

Data range: 0: 0 hour 00 minutes 00 second to 9 hours 59 minutes 59 seconds

2: 0 minutes 00.00 seconds to 9 minutes 59.99 seconds

Factory set value: 2

Related parameters: Area soak time (P. 71)

Input 1_setting limiter high	Data register area for static data read (Byte)	No assignment
	Function number for dynamic data request	D1H (209)
Input 2_setting limiter high	Data register area for static data read (Byte)	No assignment
	Function number for dynamic data request	D3H (211)

Use to set a high limit of the set value.

Attribute: R/W (Read and Write)



This item becomes RO (Read only) during control RUN.

Data range: Setting limiter low to Input scale high

Factory set value: Input 1_setting limiter high: Input 1_input scale high

Input 2_setting limiter high: Input 2_input scale high

Related parameters: Decimal point position (P. 88), Input scale high (P. 89),
Setting limiter low (P. 138)

Setting Limiter: Setting Limiter is to set the range of the Set value (SV).

Example: The input range (input scale range) is from 0 to 400 °C, the setting limiter high is 200 °C, and the setting limiter low is 20 °C.

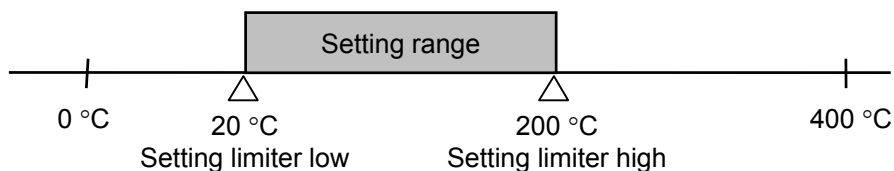

Input 1_setting limiter low	Data register area for static data read (Byte)	No assignment
	Function number for dynamic data request	D2H (210)
Input 2_setting limiter low	Data register area for static data read (Byte)	No assignment
	Function number for dynamic data request	D4H (212)

Use to set a low limit of the set value.

Attribute: R/W (Read and Write)

 **This item becomes RO (Read only) during control RUN.**

Data range: Input scale low to Setting limiter high

Factory set value: Input 1_setting limiter low: Input 1_input scale low
 Input 2_setting limiter low: Input 2_input scale low

Related parameters: Decimal point position (P. 88), Input scale low (P. 90),
 Setting limiter high (P. 137)

Functional description:
 Refer to the setting limiter high.

ROM version display	Data register area for static data read (Byte)	No assignment
	Function number for dynamic data request	D5H (213)

This value is a version of the ROM loaded on the controller.

Attribute: RO (Read only)

Data range: Displays the version of loading software.

Factory set value: —

Integrated operating time display	Data register area for static data read (Byte)	No assignment
	Function number for dynamic data request	D6H (214)

This value is an integrated operating time of the controller.

Attribute: RO (Read only)
 Data range: 0 to 99999 hours
 Factory set value: —

Holding peak value ambient temperature display	Data register area for static data read (Byte)	No assignment
	Function number for dynamic data request	D7H (215)

This value is a maximum ambient temperature of the instrument.

Attribute: RO (Read only)
 Data range: -10.0 to +100.0 °C
 Factory set value: —

Power feed transformer input value display	Data register area for static data read (Byte)	No assignment
	Function number for dynamic data request	D8H (216)

This value is the input value of a power feed forward transformer.

Attribute: RO (Read only)
 Data range: 0.0 to 160.0 %
 Displays in the percentage of the rated value.
 Factory set value: —

Feedback resistance (FBR) input assignment	Data register area for static data read (Byte)	No assignment
	Function number for dynamic data request	D9H (217)

Use to assign the feedback resistance (FBR) input to an input.

Attribute: R/W (Read and Write)

 **This item becomes RO (Read only) during control RUN.**

Data range: 1: Input 1
2: Input 2

Factory set value: 1

Related parameters: Open/Close output differential gap (P. 134),
Action at feedback resistance (FBR) input error (P. 134),
Feedback adjustment (P. 135)

Input 1_power feed forward gain	Data register area for static data read (Byte)	No assignment
	Function number for dynamic data request	DAH (218)
Input 2_power feed forward gain	Data register area for static data read (Byte)	No assignment
	Function number for dynamic data request	DBH (219)

Use to set a gain used for the power feed forward (PFF) function. Power Feed Forward gain should not be changed under ordinary operation.

Attribute: R/W (Read and Write)

 **This item becomes RO (Read only) during control RUN.**

Data range: 0.01 to 5.00

Factory set value: Input 1_power feed forward gain: 1.00
Input 2_power feed forward gain: 1.00

Related parameters: Power feed forward selection (P. 127)

Functional description:

Power supply voltage variations may give disturbances to the controlled temperature as they make an effect on external devices other than heaters. If in such a case, control stability can be maintained by adjusting the power feed forward gain. Usually, the instrument is used at a gain of 1.00.



Under ordinary operation, it is not necessary to change Power feed forward gain set value.

Heater break alarm 1 (HBA1) type selection	Data register area for static data read (Byte)	No assignment
	Function number for dynamic data request	DCH (220)
Heater break alarm 2 (HBA2) type selection	Data register area for static data read (Byte)	No assignment
	Function number for dynamic data request	DEH (222)

Use to select the heater break alarm type.

Attribute: R/W (Read and Write)



HBA1 type selection (ND) becomes RO (Read only) for no current transformer input 1 (CT1) specification.



HBA2 type selection (NG) becomes RO (Read only) for no current transformer input 2 (CT2) specification.

Data range: 0: Heater break alarm (HBA) type A
1: Heater break alarm (HBA) type B

Factory set value: Heater break alarm 1 (HBA1) type selection: 1
Heater break alarm 2 (HBA1) type selection: 1

Related parameters: Heater break alarm (HBA) state (P. 53),
Heater break alarm (HBA) set value (P. 73),
Heater break determination point (P. 81),
Heater melting determination point (P. 82),
Output logic selection (P. 97),
CT ratio (P. 112),
CT assignment (P. 113),
Number of heater break alarm (HBA) delay times (P. 142)

Heater Break Alarm Function:

■ Heater break alarm (HBA) type A

Heater break alarm (HBA) type A can only be used with time-proportional control output (relay, voltage pulse, or triac output). The HBA function monitors the current flowing through the load by a dedicated current transformer (CT), compares the measured value with the HBA set values, and detects a fault in the heating circuit.

■ Heater break alarm (HBA) type B

Heater break alarm (HBA) type B can be used with both continuous control output (current/voltage continuous output) and time-proportional control output (relay, voltage pulse output, or triac). The HBA function assumes that the heater current value is proportional* to the control output value of the controller, otherwise viewed as the Manipulated variable (MV), and compare it with the CT input value to detect a fault in the heating or cooling circuit.

* It is assumed that the current value flowing through the load is at maximum when the control output from the controller is 100 %, and the minimum current value flowing through the load is zero (0) when the control output from the controller is 0 %.

Number of heater break alarm 1 (HBA1) delay times	Data register area for static data read (Byte)	No assignment
	Function number for dynamic data request	DDH (221)
Number of heater break alarm 2 (HBA2) delay times	Data register area for static data read (Byte)	No assignment
	Function number for dynamic data request	DFH (223)

To prevent producing a false alarm, the alarm function waits to produce an alarm status until the measured CT input value is in an alarm range for the preset number of consecutive sampling cycles (HBA sampling cycle time: 500 ms).

Attribute: R/W (Read and Write)



This item becomes RO (Read only) during control RUN.

Data range: 0 to 255

Factory set value: Number of heater break alarm 1 (HBA1) delay times: 5
Number of heater break alarm 2 (HBA2) delay times: 5

Related parameters: Heater break alarm (HBA) state (P. 53),
Heater break alarm (HBA) set value (P. 73),
Heater break determination point (P. 81),
Heater melting determination point (P. 82),
Output logic selection (P. 97),
CT ratio (P. 112),
CT assignment (P. 113),
Heater break alarm (HBA) type selection (P. 141)

Alarm lamp lighting condition setting 1	Data register area for static data read (Byte)	No assignment
	Function number for dynamic data request	E0H (224)

Use to set an alarm (ALM) lamp lighting conditions to Event 1 to Event 4.

Attribute: R/W (Read and Write)

 **This item becomes RO (Read only) during control RUN.**

Data range: 0 to 15 (Bit data)

Bit 0 to Bit 3 are used. (Bit 4 to Bit 31: Unused)

The alarm lamp lighting condition setting 1 is assigned as a bit image in binary numbers.

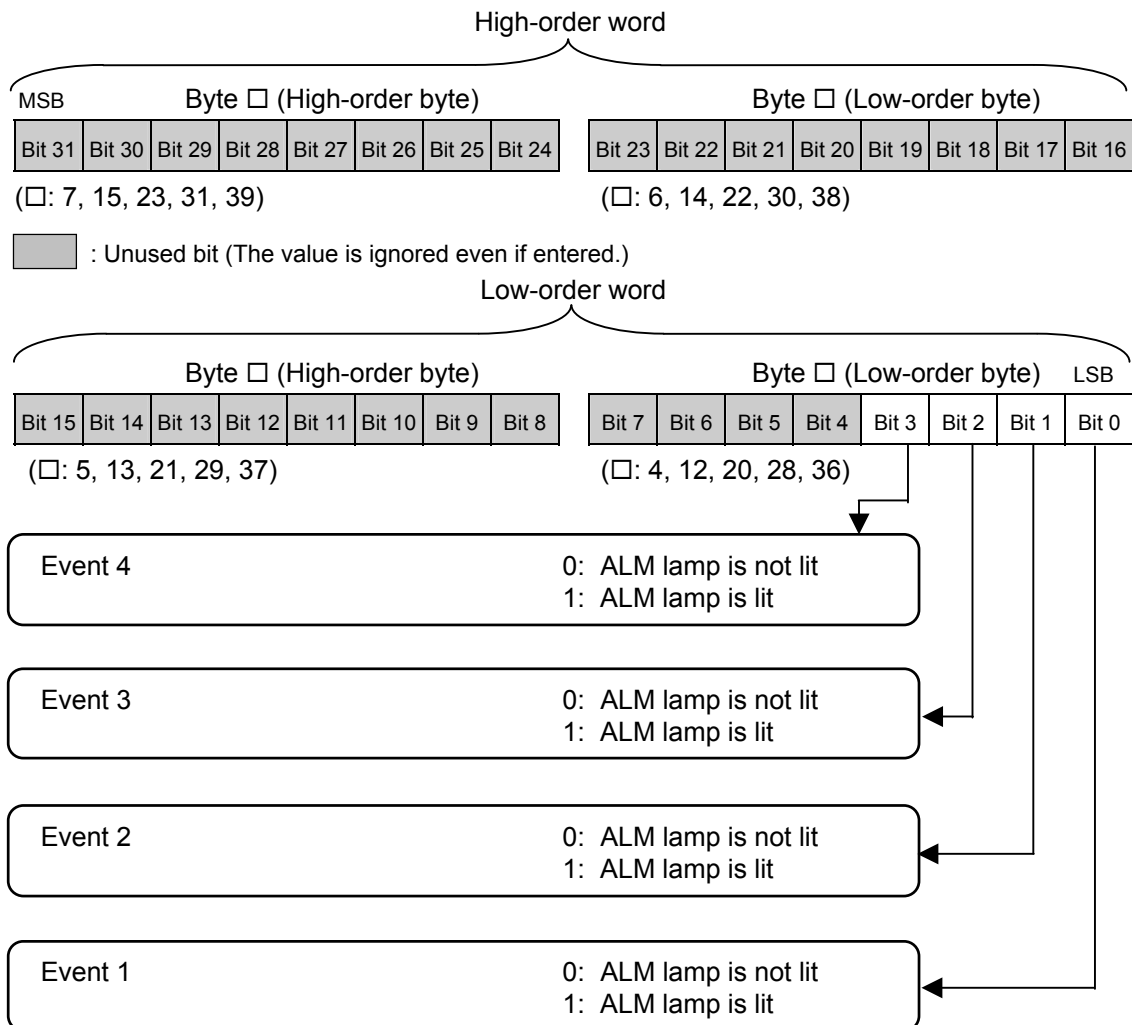

Factory set value: 15

 **The alarm lamp is lit through the *OR* operation of Event 1 to Event 4, HBA1 and HBA2 each of which is set to “1: ALM lamp is lit.”**

Alarm lamp lighting condition setting 2	Data register area for static data read (Byte)	No assignment
	Function number for dynamic data request	E1H (225)

Use to set an alarm (ALM) lamp lighting conditions to HBA1 and HBA2.

Attribute: R/W (Read and Write)

This item becomes RO (Read only) during control RUN.

Data range: 0 to 3 (Bit data)

Bit 0 and Bit 1 are used. (Bit 2 to Bit 31: Unused)

The alarm lamp lighting condition setting 2 is assigned as a bit image in binary numbers.

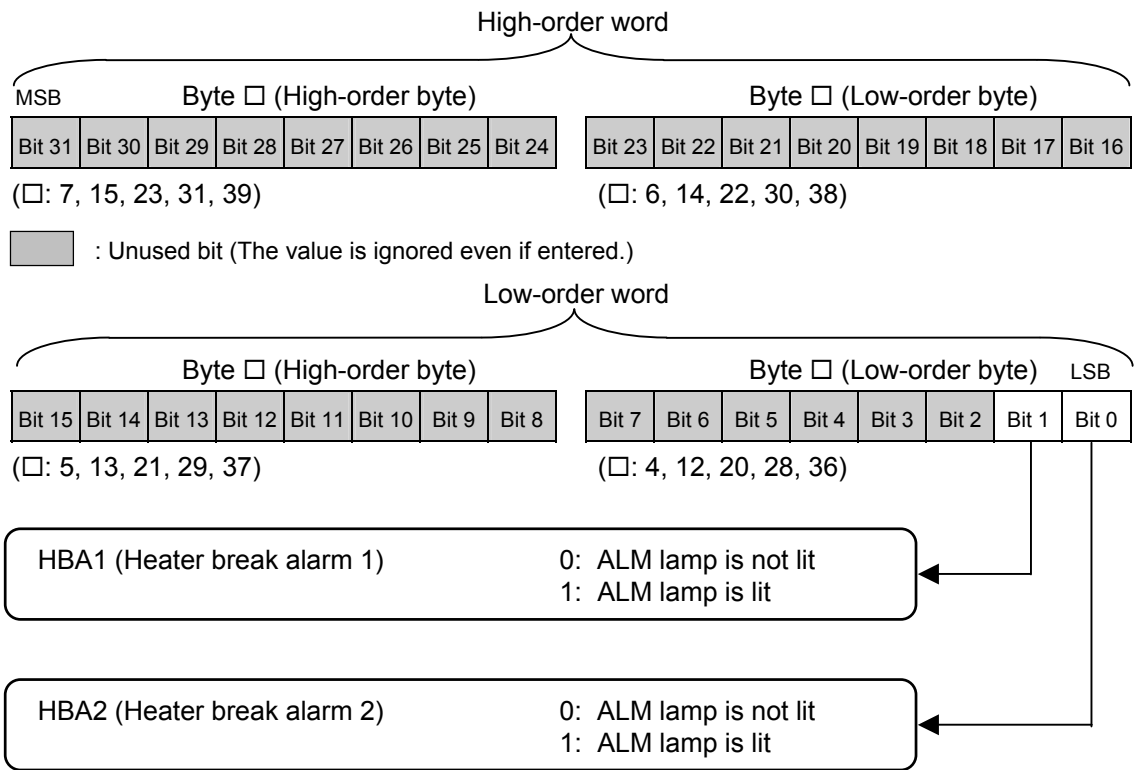

Factory set value: 3

The alarm lamp is lit through the *OR* operation of Event 1 to Event 4, HBA1 and HBA2 each of which is set to “1: ALM lamp is lit.”

7. USAGE EXAMPLE

In this Chapter, an example of using PROFIBUS communication when the Controller is connected to a PLC as a master.

7.1 Handling Procedures

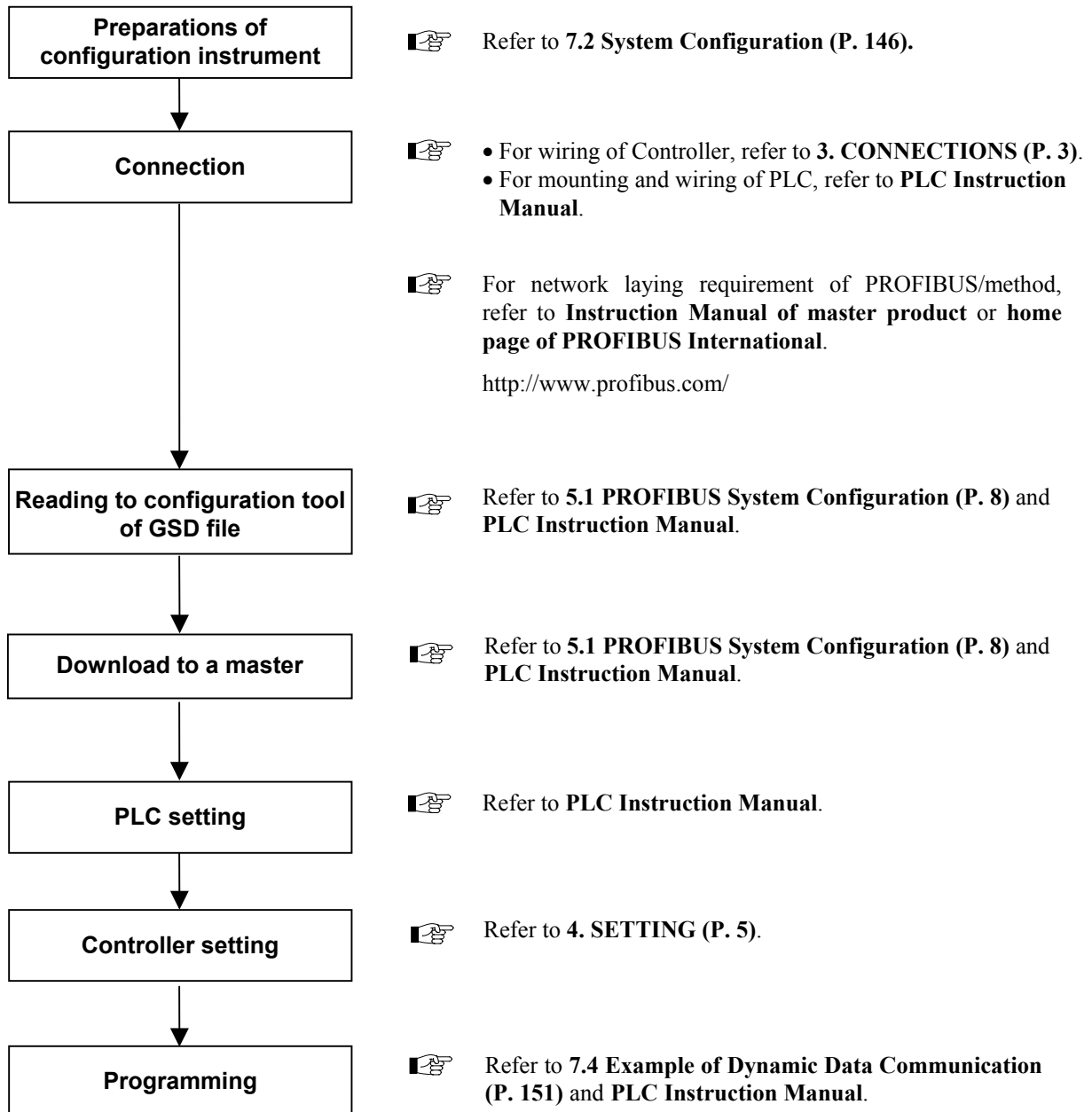

7.2 System Configuration

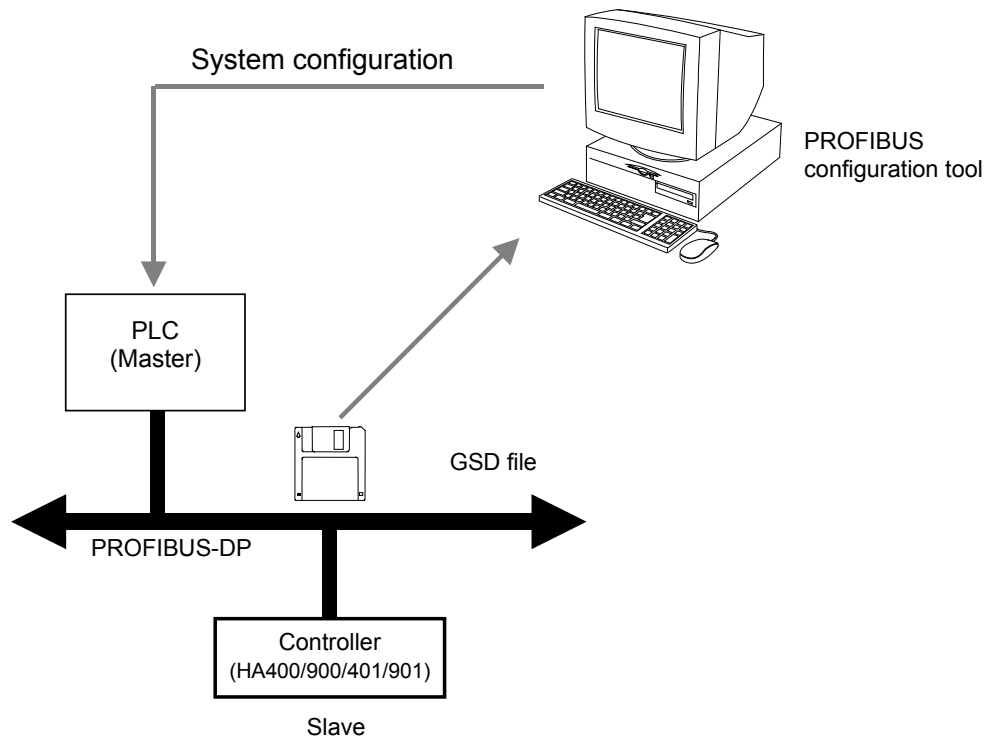

Example of system configurations

■ Use instruments

- **Controller**
HA400, HA900, HA401 or HA901
- **PLC**
SIMATIC S7-300 (SIEMENS)
CPU unit: CPU315-2 DP

7.3 Example of Data Assignment

7.3.1 Assignment of registers read by static data request (25 items = 49 words)

If the GSD file is read, the register for static data register is assigned as shown in the following.

Base address: IWr + 0

Register address	IWr + 0	IWr + 1 (High-order word)	IWr + 2 (Low-order word)	IWr + 3 (High-order word)	IWr + 4 (Low-order word)
Read item	Controller status information	Input 1_measured value (PV1) monitor		Input 2_measured value (PV2) monitor	
	IWr + 5 (High-order word)	IWr + 6 (Low-order word)	IWr + 7 (High-order word)	IWr + 8 (Low-order word)	
	Feedback resistance input value monitor			Current transformer input value 1 (CT1) monitor	
	IWr + 9 (High-order word)	IWr + 10 (Low-order word)	IWr + 11 (High-order word)	IWr + 12 (Low-order word)	
	Current transformer input value 2 (CT2) monitor			Input 1_set value (SV1) monitor	
	IWr + 13 (High-order word)	IWr + 14 (Low-order word)	IWr + 15 (High-order word)	IWr + 16 (Low-order word)	
	Input 2_set value (SV2) monitor			Remote input value monitor	
	IWr + 17 (High-order word)	IWr + 18 (Low-order word)	IWr + 19 (High-order word)	IWr + 20 (Low-order word)	
	Cascade monitor			Input 1_burnout state	
	IWr + 21 (High-order word)	IWr + 22 (Low-order word)	IWr + 23 (High-order word)	IWr + 24 (Low-order word)	
	Input 2_burnout state			Feedback resistance input burnout state	

Continued on the next page.

Continued from the previous page.

IWr + 25 (High-order word)	IWr + 26 (Low-order word)	IWr + 27 (High-order word)	IWr + 28 (Low-order word)
Event 1 state		Event 2 state	
IWr + 29 (High-order word)	IWr + 30 (Low-order word)	IWr + 31 (High-order word)	IWr + 32 (Low-order word)
Event 3 state		Event 4 state	
IWr + 33 (High-order word)	IWr + 34 (Low-order word)	IWr + 35 (High-order word)	IWr + 36 (Low-order word)
Heater break alarm 1 (HBA1) state		Heater break alarm 2 (HBA2) state	
IWr + 37 (High-order word)	IWr + 38 (Low-order word)	IWr + 39 (High-order word)	IWr + 40 (Low-order word)
Input 1_manipulated output value (MV1) monitor		Input 2_manipulated output value (MV2) monitor	
IWr + 41 (High-order word)	IWr + 42 (Low-order word)	IWr + 43 (High-order word)	IWr + 44 (Low-order word)
Error code		Event input (DI) state	
IWr + 45 (High-order word)	IWr + 46 (Low-order word)	IWr + 47 (High-order word)	IWr + 48 (Low-order word)
Operation mode state		Memory area soak time monitor	

7.3.2 Assignment of registers input by dynamic data request (8-byte × 2 = 8 words)

The registers for dynamic data requests are assigned as follows if the following conditions are satisfied.

- HA400: 1 (2-input controller)
- Number of registers used by dynamic data request: 8
- Number of data items read (for input) by dynamic data request:
2 items [Input 1_measured value (PV1), Input 2_measured value (PV2)]
- Number of data items written (for output) by dynamic data request:
2 items [Input 1_set value (SV1) and Input 2_set value (SV2) in Control area]

Basic address: IWdr + 0

Register address	IWdr + 0	IWdr + 1	IWdr + 2 (High-order word)	IWdr + 3 (Low-order word)
Input item	Read attribute and Register update information ¹	Function code ² (0001H) Input 1_measured value (PV1)	Data of Input 1_measured value (PV1)	
	IWdr + 4	IWdr + 5	IWdr + 6 (High-order word)	IWdr + 7 (Low-order word)
	Read attribute and Register update information ¹	Function code ² (0002H) Input 2_measured value (PV2)	Data of Input 2_measured value (PV2)	

¹ Read attribute and Register update information

High-order byte: Read attribute Byte 0 (Refer to P. 21)

Low-order byte: Register update information Byte 1 (Refer to P. 22)

² Function code

High-order byte: Specified memory area 0 to 16 (00H to 10H)

“0” denotes that the control area is specified.

When the function number corresponding to the communication item not included in the area is specified, that area designation is ignored.

Low-order byte: Function number 0 to 255 (00H to FFH)

7.3.3 Assignment of registers output by dynamic data request (8-byte × 2 = 8 words)

The registers for dynamic data requests are assigned as follows if the following conditions are satisfied.

- HA400: 1 (2-input controller)
- Number of registers used by dynamic data request: 8
- Number of data items read (for input) by dynamic data request:
2 items [Input 1_measured value (PV1), Input 2_measured value (PV2)]
- Number of data items written (for output) by dynamic data request:
2 items [Input 1_set value (SV1) and Input 2_set value (SV2) in Control area]

Basic address: QWdw + 0

Register address	QWdw + 0	QWdw + 1	QWdw + 2 (High-order word)	QWdw + 3 (Low-order word)
Output item	Write attribute and Register update information ¹	Function code ² (0028H) Input 1_set value (SV1)	Data of Input 1_set value (SV1)	

QWdw + 4	QWdw + 5	QWdw + 6 (High-order word)	QWdw + 7 (Low-order word)
Write attribute and Register update information ¹	Function code ² (002EH) Input 2_set value (SV2)	Data of Input 2_set value (SV2)	

¹ Write attribute and Register update information

High-order byte: Write attribute Byte 0 (Refer to P. 21)

Low-order byte: Register update information Byte 1 (Refer to P. 22)

² Function code

High-order byte: Specified memory area 0 to 16 (00H to 10H)

“0” denotes that the control area is specified.

When the function number corresponding to the communication item not included in the area is specified, that area designation is ignored.

Low-order byte: Function number 0 to 255 (00H to FFH)

7.4 Example of Dynamic Data Communication

7.4.1 Dynamic data read

An example of dynamic data communication flow when viewed from the PLC (master) side is shown in the following.

[Communication requirement]

- HA400: 1 (2-input controller)
- Number of data items read (for input) by dynamic data request:
Function code (0001H) [Input 1_measured value (PV1)]
- Measurement data: 100 [°C]
- Variable area 1 for dynamic data request: Use

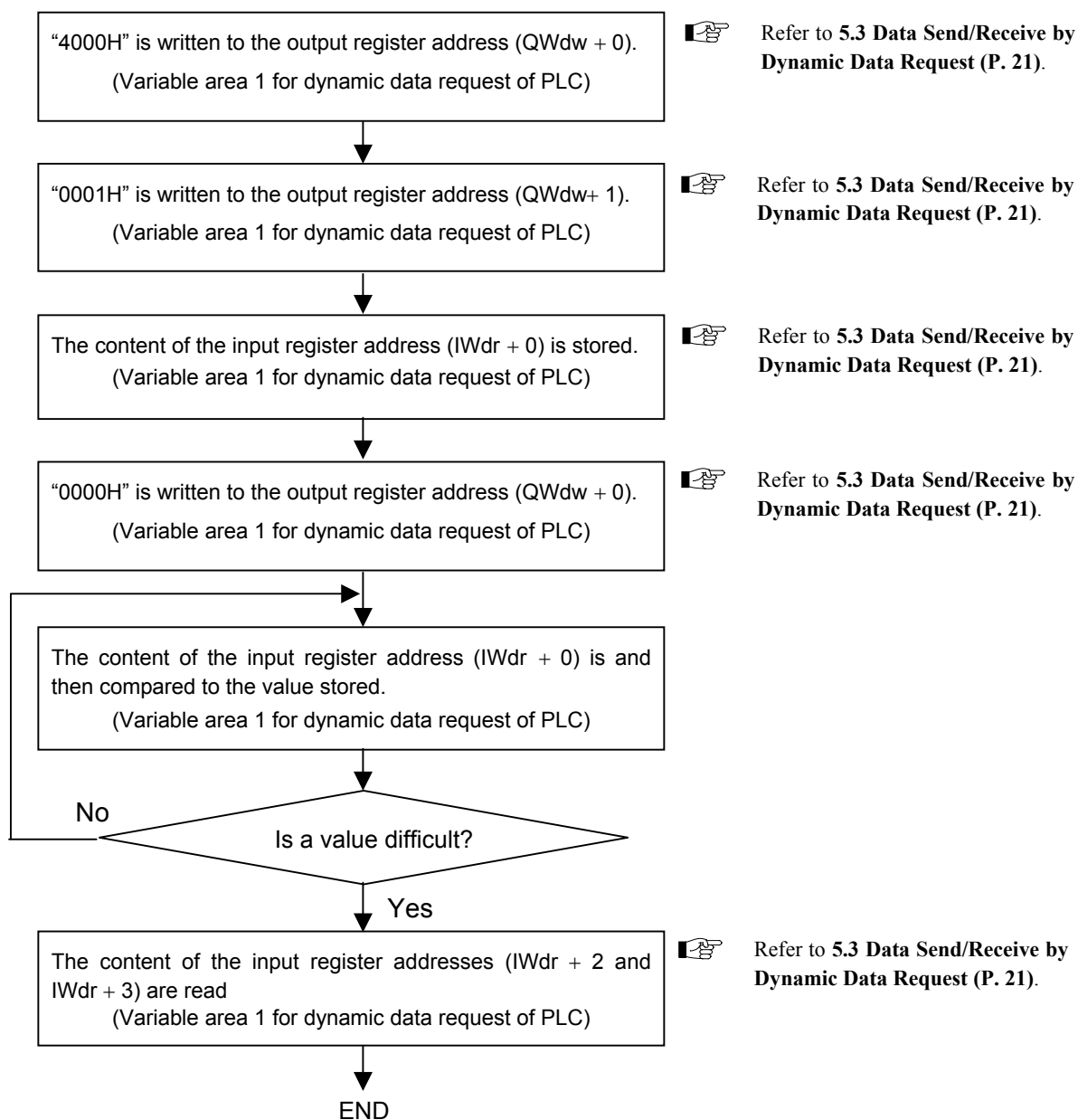

7.4.2 Dynamic data write

An example of dynamic data communication flow when viewed from the PLC (master) side is shown in the following.

[Communication requirement]

- HA400: 1 (2-input controller)
- Number of data items written (for output) by dynamic data request
Function code (0028H) [Input 1_set value (SV1) in Control area]
- Setting data: 150 [°C]
- Variable area 1 for dynamic data request: Use

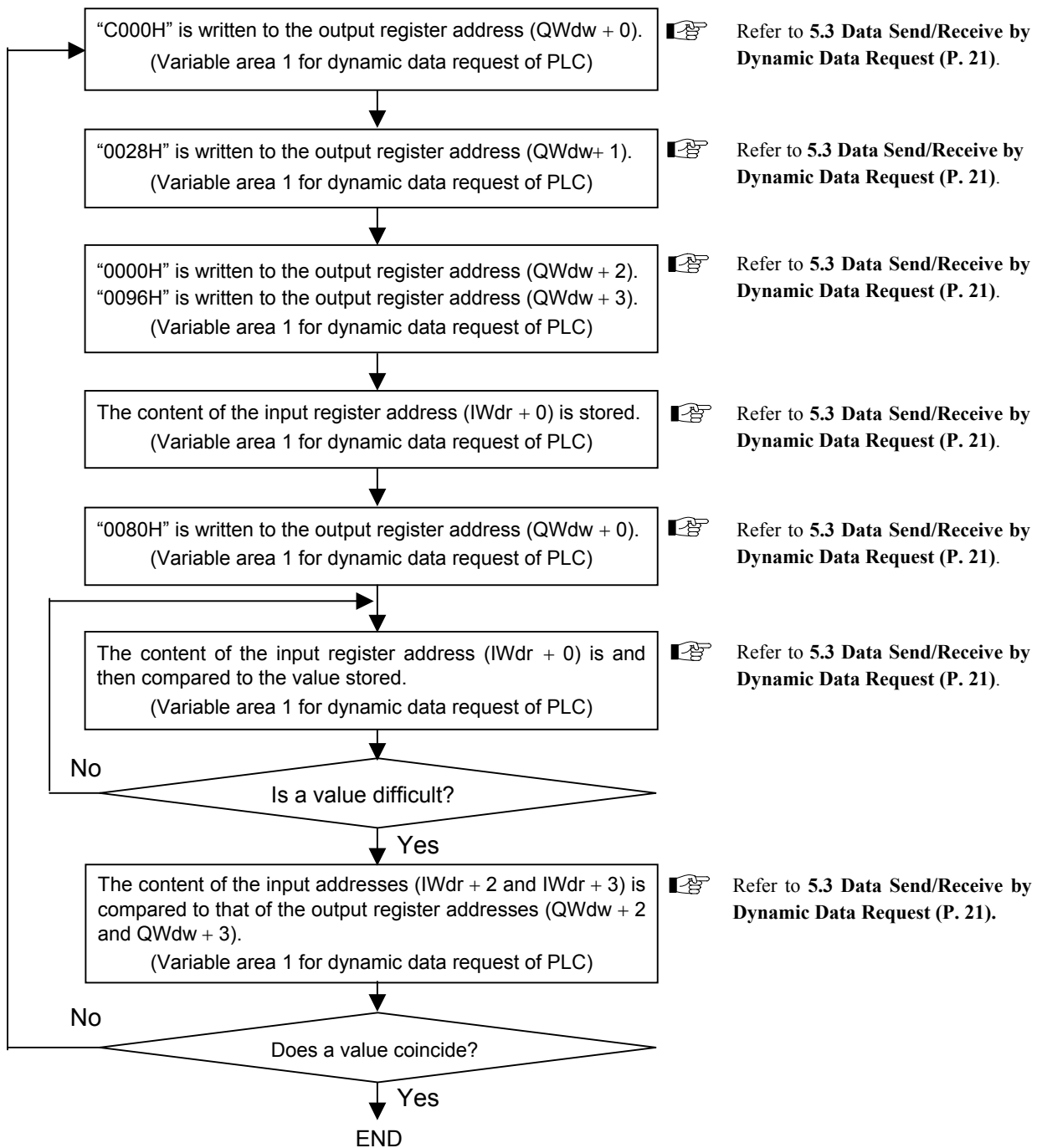

8. TROUBLESHOOTING

This section explains probable causes and solutions if any abnormality occurs in the instrument. For any inquiries or to confirm the specifications of the product, please contact RKC sales office or the agent.

If it is necessary to replace a device, always strictly observe the warnings below.



WARNING

- To prevent electric shock or instrument failure, always turn off the system power before replacing the instrument.
- To prevent electric shock or instrument failure, always turn off the power before mounting or removing the instrument.
- To prevent electric shock or instrument failure, do not turn on the power until all wiring is completed. Make sure that the wiring is correct before applying power to the instrument.
- To prevent electric shock or instrument failure, do not touch the inside of the instrument.
- All wiring must be performed by authorized personnel with electrical experience in this type of work.

CAUTION

All wiring must be completed before power is turned on to prevent electric shock, instrument failure, or incorrect action. The power must be turned off before repairing work for input break and output failure including replacement of sensor, contactor or SSR, and all wiring must be completed before power is turned on again.

Problem	Possible cause	Solution
No response	Wrong connection, no connection or disconnection of the communication cable	Confirm the connection method or condition and connect correctly
	Breakage, wrong wiring, or imperfect contact of the communication cable	Confirm the wiring or connector and repair or replace the wrong one
	Wrong PROFIBUS address setting	Confirm the address setting and set that correctly
Not recognized by a PROFIBUS master	Wrong initialization of PROFIBUS	Turn on the power of Controller (HA400/900/401/901) once again.
Cannot write the value at dynamic data request	MSB (Bit 7) of byte □ (□: 0, 8, 16, 24, and 32) of variable area for dynamic data request is not 1.	Change the sequence so that MSB (Bit 7) of byte □ (□: 0, 8, 16, 24, and 32) becomes 1.
	Bit 6 of byte □ (□: 0, 8, 16, 24, and 32) of variable area for dynamic data request is 1.	Change the sequence so that Bit 6 of byte □ (□: 0, 8, 16, 24, and 32) becomes 0.



RKC INSTRUMENT INC.

HEADQUARTERS: 16-6, KUGAHARA 5-CHOME, OHTA-KU TOKYO 146-8515 JAPAN

PHONE: 03-3751-9799 (+81 3 3751 9799)

E-mail: info@rkcinst.co.jp

FAX: 03-3751-8585 (+81 3 3751 8585)