



# HA430/HA930 Instruction Manual

IMR01N11-E8 All Rights Reserved, Copyright © 2003, RKC INSTRUMENT INC. Thank you for purchasing this RKC product. In order to achieve maximum performance and ensure proper operation of the instrument, carefully read all the instructions in this manual. Please place the manual in a convenient location for easy reference.

For detailed handling procedures and key operations, refer to separate HA430/HA930 Operation Manual (IMR01N12-ED). The manual can be downloaded from the official RKC website: [http://www.rkcinst.com/english/manual\\_load.htm](http://www.rkcinst.com/english/manual_load.htm).

## WARNING

- To prevent injury to persons, damage to the instrument and the equipment, a suitable external protection device shall be required.
- All wiring must be completed before power is turned on to prevent electric shock, fire or damage to the instrument and the equipment.
- This instrument must be used in accordance with the specifications to prevent fire or damage to the instrument and the equipment.
- This instrument is not intended for use in locations subject to flammable or explosive gases.
- Do not touch high-voltage connections such as power supply terminals, etc. to avoid electric shock.
- RKC is not responsible if this instrument is repaired, modified or disassembled by other than factory-approved personnel. Malfunction may occur and warranty is void under these conditions.

## CAUTION

- This product is intended for use with industrial machines, test and measuring equipment. (It is not designed for use with medical equipment and nuclear energy plant.)
- This is a Class A instrument. In a domestic environment, this instrument may cause radio interference, in which case the user may be required to take additional measures.
- This instrument is protected from electric shock by reinforced insulation. Provide reinforced insulation between the wire for the input signal and the wires for instrument power supply, source of power and loads.
- Be sure to provide an appropriate surge control circuit respectively for the following:
  - If input/output or signal lines within the building are longer than 30 meters.
  - If input/output or signal lines leave the building, regardless the length.
- This instrument is designed for installation in an enclosed instrumentation panel. All high-voltage connections such as power supply terminals must be enclosed in the instrumentation panel to avoid electric shock to operating personnel.
- All precautions described in this manual should be taken to avoid damage to the instrument or equipment.
- If the equipment is used in a manner not specified by the manufacturer, the protection provided by the equipment may be impaired.
- All wiring must be in accordance with local codes and regulations.
- All wiring must be completed before power is turned on to prevent electric shock, instrument failure, or incorrect action. The power must be turned off before repairing work for input break and output failure including replacement of sensor, contactor or SSR, and all wiring must be completed before power is turned on again.
- To prevent instrument damage as a result of failure, protect the power line and the input/output lines from high currents with a suitable overcurrent protection device with adequate breaking capacity such as a fuse, circuit breaker, etc.
- A malfunction in this product may occasionally make control operations impossible or prevent alarm outputs, resulting in a possible hazard. Take appropriate measures in the end use to prevent hazards in the event of malfunction.
- Prevent metal fragments or lead wire scraps from falling inside instrument case to avoid electric shock, fire or malfunction.
- Tighten each terminal screw to the specified torque found in the manual to avoid electric shock, fire or malfunction.
- For proper operation of this instrument, provide adequate ventilation for heat dissipation.
- Do not connect wires to unused terminals as this will interfere with proper operation of the instrument.
- Turn off the power supply before cleaning the instrument.
- Do not use a volatile solvent such as paint thinner to clean the instrument. Deformation or discoloration may occur. Use a soft, dry cloth to remove stains from the instrument.
- To avoid damage to the instrument display, do not rub with an abrasive material or push the front panel with a hard object.

## NOTICE

- This manual assumes that the reader has a fundamental knowledge of the principles of electricity, process control, computer technology and communications.
- The figures, diagrams and numeric values used in this manual are only for explanation purpose.
- RKC is not responsible for any damage or injury that is caused as a result of using this instrument, instrument failure or indirect damage.
- RKC is not responsible for any damage and/or injury resulting from the use of instruments made by imitating this instrument.
- Periodic maintenance is required for safe and proper operation of this instrument. Some components have a limited service life, or characteristics that change over time.
- Every effort has been made to ensure accuracy of all information contained herein. RKC makes no warranty, expressed or implied, with respect to the accuracy of the information. The information in this manual is subject to change without prior notice.
- No portion of this document may be reprinted, modified, copied, transmitted, digitized, stored, processed or retrieved through any mechanical, electronic, optical or other means without prior written approval from RKC.

## Product Check

Mounting brackets: 2 [HA430], 4 [HA930]  
Instruction Manual: 1 [IMR01N11-E8]

## 1. MOUNTING

### WARNING

To prevent electric shock or instrument failure, always turn off the power before mounting or removing the instrument.

### Mounting Cautions

- This instrument is intended to be used under the following environmental conditions. (IEC 61010-1) [OVERVOLTAGE CATEGORY II, POLLUTION DEGREE 2]
  - Allowable ambient temperature: -10 to +50 °C (14 to 122 °F)
  - Allowable ambient humidity: 5 to 95 %RH (Absolute humidity: MAX. W. C 29 g/m<sup>3</sup> dry air at 101.3 kPa)
- Avoid the following conditions when selecting the mounting location:
  - Rapid changes in ambient temperature which may cause condensation.
  - Excessive dust, salt or iron particles.
  - Corrosive or inflammable gases.
  - Excessive induction noise, static electricity, magnetic fields or noise.
  - Direct vibration or shock to the mainframe.
  - Direct air flow from an air conditioner.
  - Water, oil, chemicals, vapor or steam splashes.
  - Exposure to direct sunlight.
  - Excessive heat accumulation.
- Mount this instrument in the panel considering the following conditions:
  - Provide adequate ventilation space so that heat does not build up.
  - Do not mount this instrument directly above the equipment that generates large amount of heat (heaters, transformers, semi-conductor functional devices, large-wattage resistors.)
  - If the ambient temperature rises above 50 °C (122 °F), cool this instrument with a forced air fan, cooler, etc. Cooled air should not blow directly on this instrument.
  - In order to improve safety and the immunity to withstand noise, mount this instrument as far away as possible from high voltage equipment, power lines, and rotating machinery.
    - High voltage equipment: Do not mount within the same panel.
    - Power lines: Separate at least 200 mm.
    - Rotating machinery: Separate as far as possible.
- For correct functioning mount this instrument in a horizontal position.
- In case this instrument is connected to a supply by means of a permanent connection, a switch or circuit-breaker shall be included in the installation. This shall be in close proximity to the equipment and within easy reach of the operator. It shall be marked as the disconnecting device for the equipment.

### Dimensions

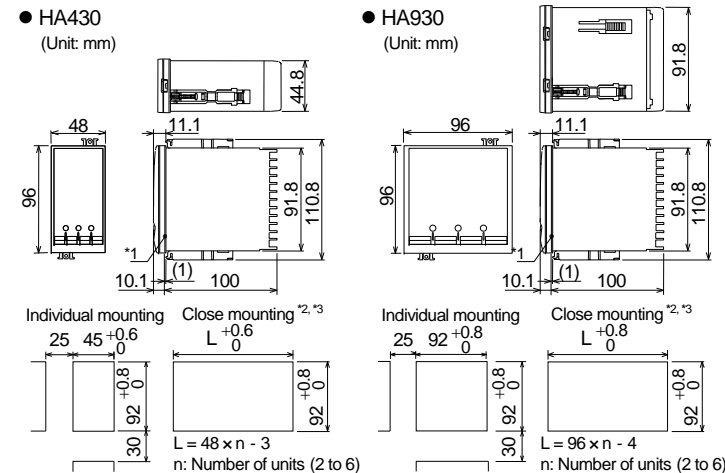

<sup>1</sup> Rubber gasket  
<sup>2</sup> If the HA430s or HA930s have waterproof/dustproof, protection will be compromised and not meet IP65 by close mounting.  
<sup>3</sup> When controllers are closely mounted, ambient temperature must not exceed 50 °C (122 °F).  
 For mounting of the HA430 or HA930, panel thickness must be between 1 to 10 mm.  
 When mounting multiple HA430s or HA930s close together, the panel strength should be checked to ensure proper support.

### Mounting Procedures

- Prepare the panel cutout as specified in ■ Dimensions.
- Insert the instrument through the panel cutout.
- Insert the mounting bracket into the mounting groove of the instrument. Do not push the mounting bracket forward. (Fig. 1)
- Secure the bracket to the instrument by tightening the screw. Take care to refrain from moving the bracket forward.
- Only turn about one full revolution after the screw touches the panel. (Fig. 2)

If the screw has been rotated too tight, the screw may turn idle. In such a case, loosen the screw once and tighten it again until the instrument is firmly fixed.

- The other mounting bracket should be installed in the same way as described in 3. to 5.

When the instrument is mounted, always secure with two mounting brackets so that upper and lower mounting brackets are positioned diagonally.  
 The waterproof/dustproof (supplied as standard) on the front of the instrument conforms to IP65 when mounted on the panel. Checked and confirmed its compliance through the internal test at RKC. For effective waterproof/dustproof, the gasket must be securely placed between the instrument and the panel without any gap. If the gasket is damaged, please contact RKC sales office or the agent.

### Removal Procedures

- Turn the power OFF.
- Remove the wiring.
- Loosen the screw of the mounting bracket.
- Hold the mounting bracket by the edge (1) and tilt it (2) to remove from the case. (Fig. 3)
- The other mounting bracket should be removed in the same way as described in 3. and 4.
- Pull out the instrument from the mounting cutout while holding the front panel frame of this instrument. (Fig. 4)

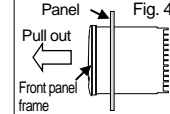
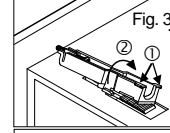
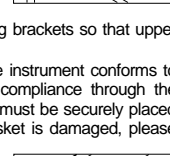
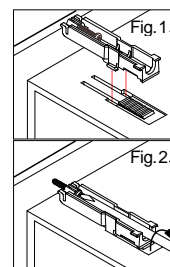

## 2. WIRING

### WARNING

To prevent electric shock or instrument failure, do not turn on the power until all wiring is completed. Make sure that the wiring is correct before applying power to the instrument.

### Wiring Cautions

- For thermocouple input, use the appropriate compensation wire.
- For RTD input, use low resistance lead wire with no difference in resistance between the three lead wires.
- Signal connected to Voltage input and Current input shall be low voltage defined as "SELV" circuit per IEC 60950-1.
- To avoid noise induction, keep input signal wire away from instrument power line, load lines and power lines of other electric equipment.
- Use a special shielded cable for connection with the pressure sensor. When using our CZ-100P or CZ-200P: The rated output (mV/V) of pressure sensor is when the cable is at a length of 5 m. If the cable is extended, correct the rated output using the following equation. Set the correction value thus calculated to "Gain setting." For the Gain setting screen, refer to HA430/HA930 Operation Manual (IMR01N12-ED).

$$\text{Correction equation: } e1 = e2 (1 + K \cdot L) \rightarrow e2 = \frac{e1}{1 + K \cdot L}$$

e1: Rated output in standard-cable length 5 m (mV/V is described on the nameplate of the sensor)  
 e2: Rated output after extension  
 K: Correction factor\* 1.96 x 10<sup>-4</sup>/m [Non-explosionproof specification type], 1.40 x 10<sup>-4</sup>/m [Explosionproof specification type]  
 \* When using 0.5 mm<sup>2</sup> x 4-core shielded cable (standard-cable) or equal.  
 L: Extended cable length (m)

- If there is electrical noise in the vicinity of the instrument that could affect operation, use a noise filter.

### Terminal Configuration (All the terminal configuration of HA430 and HA930 is the same.)

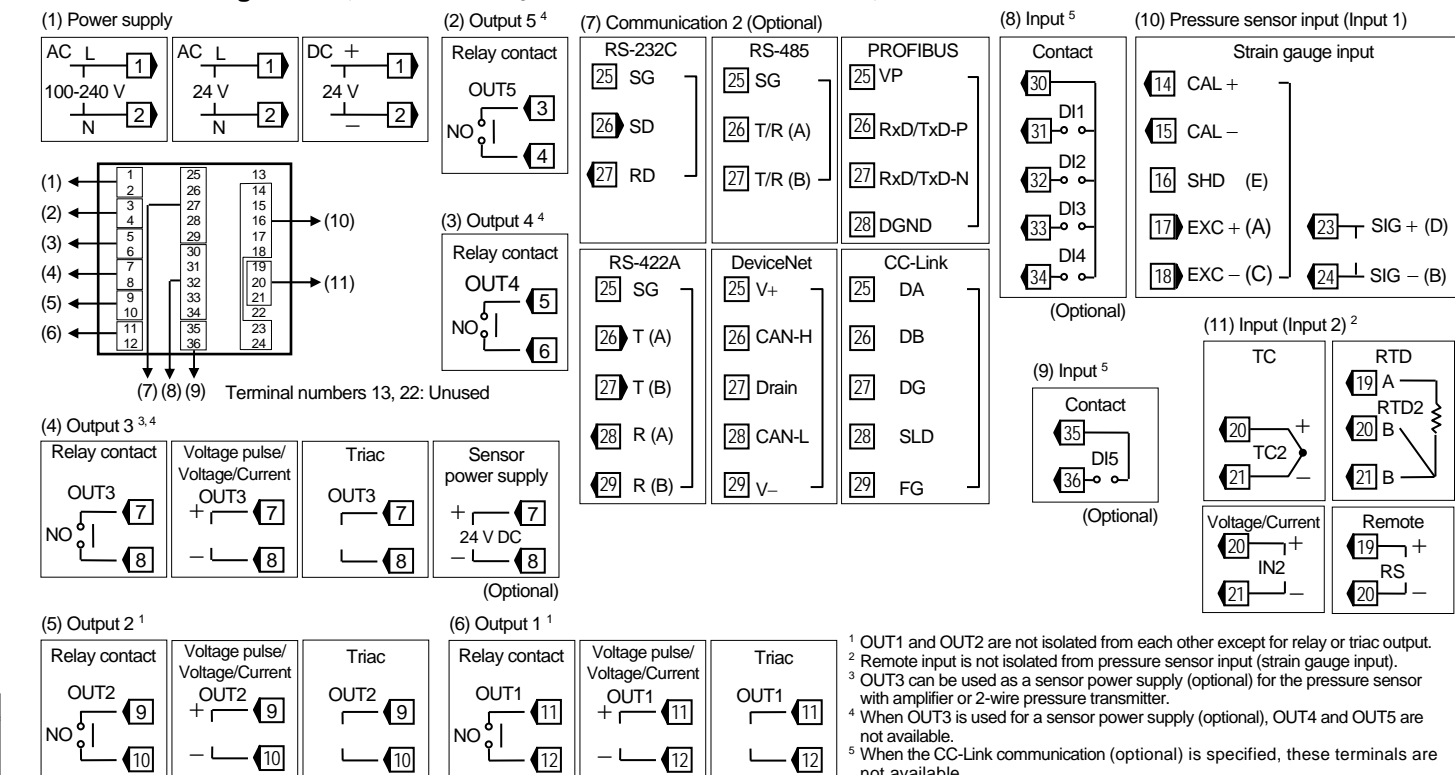

- Shorten the distance between the twisted power supply wire pitches to achieve the most effective noise reduction.
- Always install the noise filter on a grounded panel. Minimize the wiring distance between the noise filter output and the instrument power supply terminals to achieve the most effective noise reduction.
- Do not connect fuses or switches to the noise filter output wiring as this will reduce the effectiveness of the noise filter.
- Allow approximately 5 seconds for contact output when the instrument is turned on. Use a delay relay when the output line is used for an external interlock circuit.
- Power supply wiring must be twisted and have a low voltage drop.
- This instrument is not provided with an overcurrent protection device. For safety install an overcurrent protection device (such as a fuse) with adequate breaking capacity close to the instrument.
  - Fuse type: Time-lag fuse (Approved fuse according IEC 60127-2 and/or UL 248-14)
  - Fuse rating: Rated current: 1.0 A
- For an instrument with 24 V power supply input, supply power from a "SELV" circuit defined as IEC 60950-1.
- A suitable power supply should be considered in the end-use equipment. The power supply must be in compliance with a limited-energy circuits (maximum available current of 8 A).
- Use the solderless terminal appropriate to the screw size.
  - Screw size: M3 x 6 (With 5.8 x 8 square washer)
  - Recommended tightening torque: 0.4 N·m (4 kgf·cm)
  - Specified dimension: Refer to Fig. at the right
  - Specified solderless terminals: With isolation
  - Applicable wire: Solid/twisted wire of 0.25 to 1.65 mm<sup>2</sup>
- Make sure that during field wiring parts of conductors cannot come into contact with adjacent conductive parts.

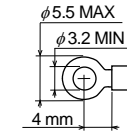

### Specifications

Power supply voltage:	90 to 264 V AC [Including power supply voltage variation] (Rating: 100 to 240 V AC), 50/60 Hz 21.6 to 26.4 V AC [Including power supply voltage variation] (Rating: 24 V AC), 50/60 Hz 21.6 to 26.4 V DC [Including power supply voltage variation] (Rating: 24 V DC)	Output 1 to Output 3:	Relay contact output: 250 V AC, 3 A (Resistive load), 1a contact Electrical life: 300,000 times or more (Rated load) 0/12 V DC (Allowable load resistance 600 Ω or more) 0 to 20 mA DC, 4 to 20 mA DC (Allowable load resistance 600 Ω or less)
Power consumption:	HA430: 16.5 VA max. (at 100 V AC) 22.5 VA max. (at 240 V AC) 15.0 VA max. (at 24 V AC) 430 mA max. (at 24 V DC) HA930: 17.5 VA max. (at 100 V AC) 24.0 VA max. (at 240 V AC) 16.0 VA max. (at 24 V AC) 470 mA max. (at 24 V DC)	Voltage pulse output:	0 to 5 V DC, 1 to 5 V DC, 0 to 10 V DC (Allowable load resistance 1 kΩ or more)
Input 1:	Pressure sensor input Relevant sensor: Strain gauge type pressure sensor	Current output:	Allowable load current: 0.4 A Minimum load current: 30 mA Load voltage: 75 to 250 V AC
Input 2:	TC input, RTD input, Voltage input, Current input	Voltage output:	0 to 5 V DC, 1 to 5 V DC, 0 to 10 V DC (Allowable load resistance 1 kΩ or more)
Optional input:	Remote input (Not isolation type), Event input	Triac output:	Allowable load current: 0.4 A Minimum load current: 30 mA Load voltage: 75 to 250 V AC
Power supply for strain gauge type of pressure sensor:	Rated voltage (EXC): 8 V DC ±3 % Temperature drift: 80 ppm/°C Rated current: 30 mA max.	Output 4 and Output 5:	Relay contact output: 250 V AC, 1 A (Resistive load), 1a contact Electrical life: 300,000 times or more (Rated load) Brilliant PID control (Direct action or Reverse action is available)
Sensor power supply output (Optional):	OUT3 is used Rated voltage: 24 V DC ±5 % Rated current: 24 mA max.	Control method:	Brilliant PID control (Direct action or Reverse action is available)
		Allowable ambient temperature:	-10 to +50 °C (14 to 122 °F)
		Allowable ambient humidity:	5 to 95 %RH Absolute humidity: MAX. W.C 29 g/m <sup>3</sup> dry air at 101.3 kPa There should be neither corrosive gases nor much dust.
		Operating environment:	HA430: Approx. 360 g HA930: Approx. 460 g
		Weight:	

### 3. PARTS DESCRIPTION

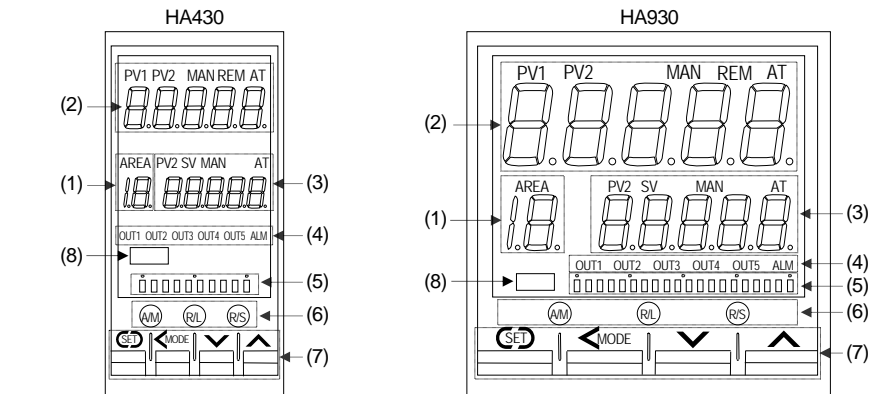

(1) Area display		
Area (AREA) lamp	[Green]	Lights when memory area number is displayed.
Memory area display		Displays memory area number (1 to 16).
(2) Upper display		
Measured value 1 (PV1) lamp	[Green]	Lights when measured value 1 (PV1) is displayed on the PV1/PV2 display unit.
Measured value 2 (PV2) lamp *	[Green]	Lights when measured value 2 (PV2) is displayed on the PV1/PV2 display unit.
Manual (MAN) mode lamp	[Green]	Lights when operated in manual mode.
Remote (REM) mode lamp	[Green]	Lights when remote setting function is activated.
Autotuning (AT) lamp	[Green]	Flashes when autotuning is activated. (After autotuning is completed: AT lamp will go out)
Measured value (PV1/PV2) display		Displays PV1, PV2 or various parameter symbols.

\* This lamp is activated only with 2-input controller.

(3) Lower display		
Measured value 2 (PV2) lamp *	[Green]	Lights when measured value 2 (PV2) is displayed on the SV display unit.
Set value (SV) lamp	[Green]	Lights when set value (SV) is displayed on the SV display unit.
Manual (MAN) mode lamp *	[Green]	Lights when operated in manual mode.
Autotuning (AT) lamp *	[Green]	Flashes when autotuning is activated. (After autotuning is completed: AT lamp will go out)
Set value (SV) display		Displays SV, PV2 or various parameter set values.

\* This lamp is activated only with 2-input controller.

(4) Output/Alarm lamp		
Output (OUT1 to OUT5) lamp	[Green]	Lights when the output corresponding to each lamp is ON.
Alarm (ALM) lamp	[Red]	Lights when alarm (Event function) is turned on. The type of alarm which is on can be checked on the event monitor display.

(5) Bar graph display *		
Manipulated output value (MV) display		Displays the manipulated output value (MV). When manipulated output value (MV) is at 0 % or less, the left-end dot of the bar-graph flashes. When MV exceeds 100 %, the right-end dot flashes.
Deviation display		Displays the deviation between the measured value (PV) and the set value (SV). When the Deviation display is selected, the dots at both ends of bar-graph light.
Measured value display		Displays the measured value (PV). Scaling is available within the input range.
Set value display		Displays the set value (SV). Scaling is available within the input range.

\* The number of dots: 10 dots (HA430), 20 dots (HA930)

(6) Direct key		
Auto/Manual transfer key		Switching the Auto/Manual control mode between Auto (PI control) mode and Manual mode.
Remote/Local transfer key		Switching the Remote/Local control mode between Remote control and Local control.
RUN/STOP transfer key		Switching the RUN/STOP mode between RUN and STOP.
(7) Operation key		
Set (SET) key		Used for calling up parameters and set value registration.
Shift key		Shifts digits when settings are changed. Used to selection operation between modes.
Down key		Decreases numerals.
Up key		Increases numerals.

(8) Infrared port		Used when sending and receiving data between this controller and the PDA installed with the RKCIR software.
-------------------	--	---

<b>To avoid damage to the instrument, never use a sharp object to press keys.</b>		
---	--	--

### 4. OPERATION FLOW OF EACH MODE

In order to make this instrument operable after being mounted on equipment and then wired, it needs to be set with operating conditions such as the set value (SV), input/output function, control function, etc. specific to each customer. In addition, the following operational flowchart illustrates key operation in each mode or each setting item. When actually setting these operating conditions specific to the customer, refer to the HA430/HA930 Operation Manual (IMR01N12-ED).

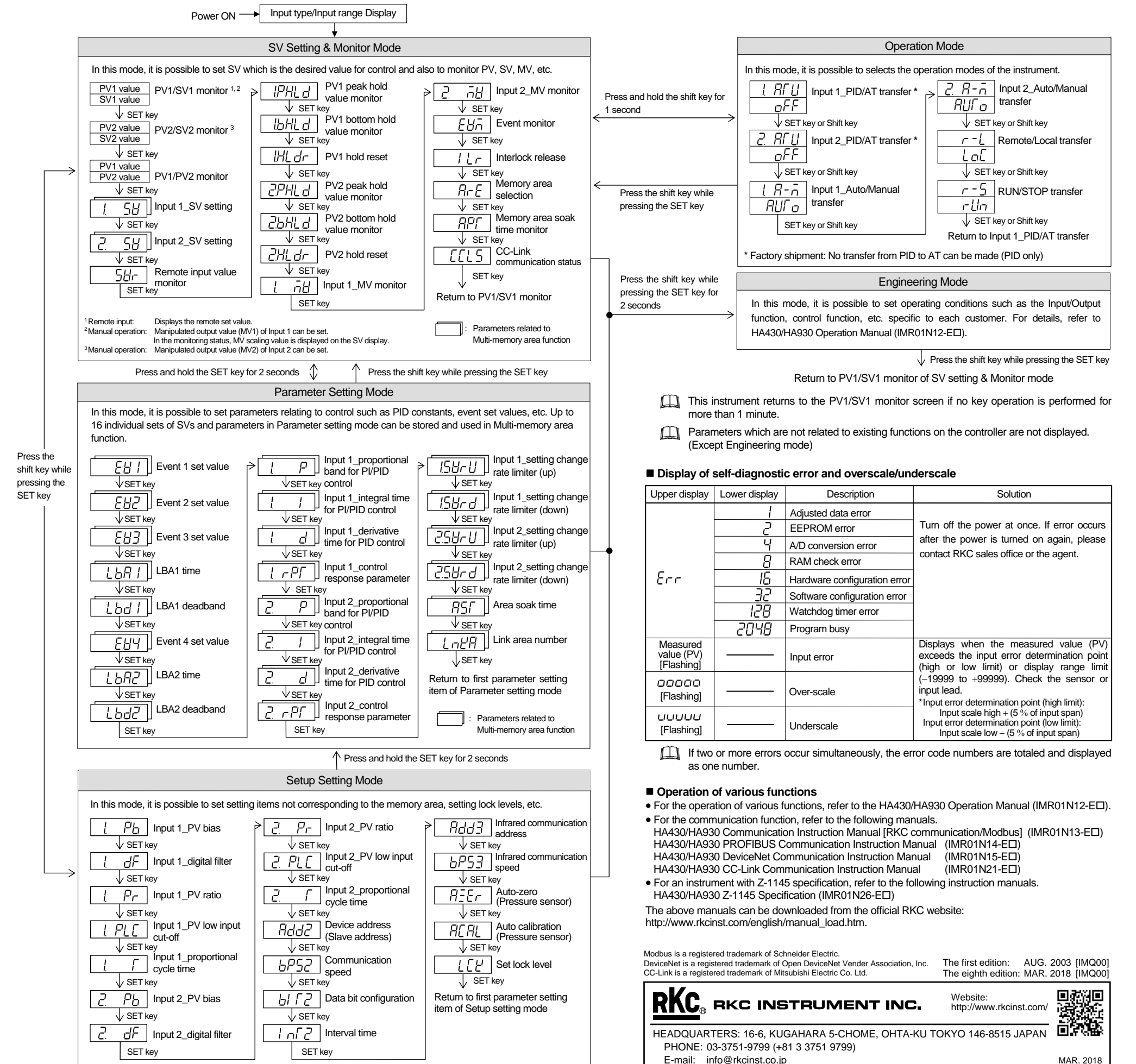

#### Display of self-diagnostic error and overscale/underscale

Upper display	Lower display	Description	Solution
Err	1	Adjusted data error	Turn off the power at once. If error occurs after the power is turned on again, please contact RKC sales office or the agent.
	2	EEPROM error	
	4	A/D conversion error	
	8	RAM check error	
	16	Hardware configuration error	
	32	Software configuration error	
	128	Watchdog timer error	
	2048	Program busy	
Measured value (PV) [Flashing]	—	Input error	Displays when the measured value (PV) exceeds the input error determination point (high or low limit) or display range limit (-19999 to +99999). Check the sensor or input lead.
00000 [Flashing]	—	Over-scale	*Input error determination point (high limit): Input scale high + (5% of input span) Input error determination point (low limit): Input scale low - (5% of input span)
UUUUU [Flashing]	—	Underscale	

If two or more errors occur simultaneously, the error code numbers are totaled and displayed as one number.

#### Operation of various functions

- For the operation of various functions, refer to the HA430/HA930 Operation Manual (IMR01N12-ED).
  - For the communication function, refer to the following manuals.
    - HA430/HA930 Communication Instruction Manual [RKC communication/Modbus] (IMR01N13-ED)
    - HA430/HA930 PROFIBUS Communication Instruction Manual (IMR01N14-ED)
    - HA430/HA930 DeviceNet Communication Instruction Manual (IMR01N15-ED)
    - HA430/HA930 CC-Link Communication Instruction Manual (IMR01N21-ED)
  - For an instrument with Z-1145 specification, refer to the following instruction manuals.
    - HA430/HA930 Z-1145 Specification (IMR01N26-ED)
- The above manuals can be downloaded from the official RKC website: [http://www.rkcinst.com/english/manual\\_load.htm](http://www.rkcinst.com/english/manual_load.htm).

Modbus is a registered trademark of Schneider Electric. DeviceNet is a registered trademark of Open DeviceNet Vendor Association, Inc. CC-Link is a registered trademark of Mitsubishi Electric Co. Ltd. The first edition: AUG. 2003 [IMQ00] The eighth edition: MAR. 2018 [IMQ00]

**RKC RKC INSTRUMENT INC.** Website: <http://www.rkcinst.com/>

HEADQUARTERS: 16-6, KUGAHARA 5-CHOME, OHTA-KU TOKYO 146-8515 JAPAN  
PHONE: 03-3751-9799 (+81 3 3751 9799)  
E-mail: [info@rkcinst.co.jp](mailto:info@rkcinst.co.jp)

MAR. 2018