Digital Controller

FB100

FB400

FB900

***Communication
Instruction Manual***

- Modbus is a registered trademark of Schneider Electric.
- Company names and product names used in this manual are the trademarks or registered trademarks of the respective companies.

Thank you for purchasing this RKC instrument. In order to achieve maximum performance and ensure proper operation of your new instrument, carefully read all the instructions in this manual. Please place the manual in a convenient location for easy reference.

NOTICE

- This manual assumes that the reader has a fundamental knowledge of the principles of electricity, process control, computer technology and communications.
- The figures, diagrams and numeric values used in this manual are only for purpose of illustration.
- RKC is not responsible for any damage or injury that is caused as a result of using this instrument, instrument failure or indirect damage.
- RKC is not responsible for any damage and/or injury resulting from the use of instruments made by imitating this instrument.
- Periodic maintenance is required for safe and proper operation of this instrument. Some components have a limited service life, or characteristics that change over time.
- Every effort has been made to ensure accuracy of all information contained herein. RKC makes no warranty expressed or implied, with respect to the accuracy of the information. The information in this manual is subject to change without prior notice.
- No portion of this document may be reprinted, modified, copied, transmitted, digitized, stored, processed or retrieved through any mechanical, electronic, optical or other means without prior written approval from RKC.



WARNING

- An external protection device must be installed if failure of this instrument could result in damage to the instrument, equipment or injury to personnel.
- All wiring must be completed before power is turned on to prevent electric shock, fire or damage to instrument and equipment.
- This instrument must be used in accordance with the specifications to prevent fire or damage to instrument and equipment.
- This instrument is not intended for use in locations subject to flammable or explosive gases.
- Do not touch high-voltage connections such as power supply terminals, etc. to avoid electric shock.
- RKC is not responsible if this instrument is repaired, modified or disassembled by other than factory-approved personnel. Malfunction can occur and warranty is void under these conditions.

CAUTION

- This product is intended for use with industrial machines, test and measuring equipment. (It is not designed for use with medical equipment and nuclear energy.)
- This is a Class A instrument. In a domestic environment, this instrument may cause radio interference, in which case the user may be required to take additional measures.
- This instrument is protected from electric shock by reinforced insulation. Provide reinforced insulation between the wire for the input signal and the wires for instrument power supply, source of power and loads.
- Be sure to provide an appropriate surge control circuit respectively for the following:
 - If input/output or signal lines within the building are longer than 30 meters.
 - If input/output or signal lines leave the building, regardless the length.
- This instrument is designed for installation in an enclosed instrumentation panel. All high-voltage connections such as power supply terminals must be enclosed in the instrumentation panel to avoid electric shock by operating personnel.
- All precautions described in this manual should be taken to avoid damage to the instrument or equipment.
- All wiring must be in accordance with local codes and regulations.
- All wiring must be completed before power is turned on to prevent electric shock, instrument failure, or incorrect action.

The power must be turned off before repairing work for input break and output failure including replacement of sensor, contactor or SSR, and all wiring must be completed before power is turned on again.
- To prevent instrument damage or failure, protect the power line and the input/output lines from high currents with a protection device such as fuse, circuit breaker, etc.
- Prevent metal fragments or lead wire scraps from falling inside instrument case to avoid electric shock, fire or malfunction.
- Tighten each terminal screw to the specified torque found in the manual to avoid electric shock, fire or malfunction.
- For proper operation of this instrument, provide adequate ventilation for heat dispensation.
- Do not connect wires to unused terminals as this will interfere with proper operation of the instrument.
- Turn off the power supply before cleaning the instrument.
- Do not use a volatile solvent such as paint thinner to clean the instrument. Deformation or discoloration will occur. Use a soft, dry cloth to remove stains from the instrument.
- To avoid damage to instrument display, do not rub with an abrasive material or push front panel with a hard object.
- Do not connect modular connectors to telephone line.
- When high alarm with hold action/re-hold action is used for Event function, alarm does not turn on while hold action is in operation. Take measures to prevent overheating which may occur if the control device fails.

FOR PROPER DISPOSAL

- When disposing of each part used for this instrument, always follows the procedure for disposing of industrial wastes stipulated by the respective local community.

SYMBOLS

Safety Symbols:

WARNING : This mark indicates precautions that must be taken if there is danger of electric shock, fire, etc., which could result in loss of life or injury.

CAUTION : This mark indicates that if these precautions and operating procedures are not taken, damage to the instrument may result.



: This mark indicates that all precautions should be taken for safe usage.



: This mark indicates important information on installation, handling and operating procedures.



: This mark indicates supplemental information on installation, handling and operating procedures.



: This mark indicates where additional information may be located.

Character Symbols:

0	1	2	3	4	5	6	7	8	9	Minus	Period
0	1	2	3	4	5	6	7	8	9	-	.

A	B (b)	C	c	D (d)	E	F	G	H	I	J	K
A	b	C	c	d	E	F	G	H	I	J	K

L	M	N (n)	O (o)	P	Q (q)	R (r)	S	T	t	U	u
L	M	N	O	P	Q	R	S	T	t	U	u

V	W	X	Y	Z	Degree	/	Dash
V	W	X	Y	Z	°	/	'

	Dim lighting
	Bright lighting
	Flashing

DOCUMENT CONFIGURATION

There are eleven manuals to this product. Please be sure to read all manuals specific to your application requirements. If you do not have a necessary manual, please contact RKC sales office, the agent, or download from the official RKC website.

The following manuals can be downloaded from the official RKC website:

http://www.rkcinst.com/english/manual_load.htm.

Manual	Manual Number	Remarks
FB100 Installation Manual	IMR01W12-E□	A product box contains this manual. This manual explains the mounting and wiring, a name of the front panel, and outline of the operation mode of the product.
FB400/FB900 Installation Manual	IMR01W01-E□	
FB100 Quick Operation Manual	IMR02W13-E□	A product box contains this manual. This manual explains the basic key operation, mode menu, and data setting.
FB400/FB900 Quick Operation Manual	IMR01W02-E□	
FB100 Parameter List	IMR02W14-E□	A product box contains this manual. This list is a compilation of the parameter data of each mode.
FB400/FB900 Parameter List	IMR01W06-E□	
FB100 Communication Quick Manual	IMR02W15-E□	A product box contains this manual. (Only FB100/400/900 provided with the communication function) This manual explains the connection method with host computer, communication parameters, and communication data (except for parameters in Engineering Mode).
FB400/FB900 Communication Quick Manual	IMR01W07-E□	
FB100 Instruction Manual *	IMR01W16-E□	This manual explains the method of the mounting and wiring, the operation of various functions, and troubleshooting.
FB400/FB900 Instruction Manual *	IMR01W03-E□	
FB100/FB400/FB900 Communication Instruction Manual *	IMR01W04-E6	This manual. This manual explains RKC communication protocol, Modbus, and relating to the communication parameters setting.

* Sold separately



Read this manual carefully before operating the instrument. Please place this manual in a convenient location for easy reference.

CONTENTS

	Page
1. OUTLINE.....	1
2. SPECIFICATIONS	2
3. WIRING	5
3.1 Connect the Communication 1	5
■ Connection to the RS-485 port of the host computer (master).....	5
■ Connection to the RS-422A port of the host computer (master)	6
■ Connection to the RS-232C port of the host computer (master)	7
■ Connection to the USB of the host computer (master).....	10
3.2 Connect the Communication 2	12
4. SETTING.....	13
4.1 Display Sequence.....	13
4.2 Description of Each Parameters	14
4.3 Setting Procedure Example	16
4.4 Communication Requirements	18
5. RKC COMMUNICATION PROTOCOL	20
5.1 Polling.....	20
5.1.1 Polling procedures	21
5.1.2 Polling procedure example.....	25
5.2 Selecting.....	26
5.2.1 Selecting procedures	26
5.2.2 Selecting procedure example.....	30
6. MODBUS COMMUNICATION PROTOCOL.....	31
6.1 Message Format.....	31
6.2 Function Code	32
6.3 Communication Mode.....	32
6.4 Slave Responses.....	33
6.5 Calculating CRC-16.....	34

	Page
6.6 Register Read and Write	37
6.6.1 Read holding registers [03H].....	37
6.6.2 Preset single register [06H].....	38
6.6.3 Diagnostics (Loopback test) [08H]	39
6.6.4 Preset multiple registers [10H]	40
6.7 Data Configuration.....	41
6.7.1 Data scale	41
6.7.2 Caution for handling communication data.....	45
6.7.3 How to use memory area data	46
6.8 How to Use Data Mapping.....	48
7. COMMUNICATION DATA LIST.....	49
■ Reference to communication data list	49
■ Communication data (RKC communication/Modbus).....	50
■ Memory area data (Modbus)	84
■ Data mapping address (Modbus)	87
8. TROUBLESHOOTING	89
9. ASCII 7-BIT CODE TABLE	92

1. OUTLINE

Digital Controller FB100/400/900 (hereafter, called controller) interfaces with the host computer via Modbus or RKC communication protocols. In addition, there is the Modbus data mapping function which enables high-speed communication by collecting only the data to be communicated at all times in the specified address area.

-  The FB100 is capable of communication when optional function E, F, G, H, or J is added. One-point communication is possible with optional functions E, F, H, and J, and two-point communication is possible with optional function G.

• Communication port

[FB100]

- There are a maximum of two communication ports: Communication 1 and Communication 2.
- When one-point communication is used, Communication 1 is used for either Host communication or Intercontroller communication.
- When two-point communication is used, Communication 2 can be used. Communication 2 is a port for Intercontroller communication, but can be also used for Host communication.

[FB400/900]

- There are two communication ports: Communication 1 and Communication 2.
- Communication 1 is used for Host communication.
- Communication 2 is used for Intercontroller communication, but can be also used for Host communication.

-  When Communication 2 is used for Host communication, refer to the **Change the protocol of the Communication 2 port (P. 15)**.

• Communication interface

Communication 1 interface: RS-422A, RS-485, RS-232C (The interface of FB100 is only RS-485.)

Communication 2 interface: RS-485

(When Communication 1 is used for RS-422A, no Communication 2 can be used.)

For reference purposes, the Modbus protocol identifies the host computer as master, the controller as slave.

■ Multi-drop connection

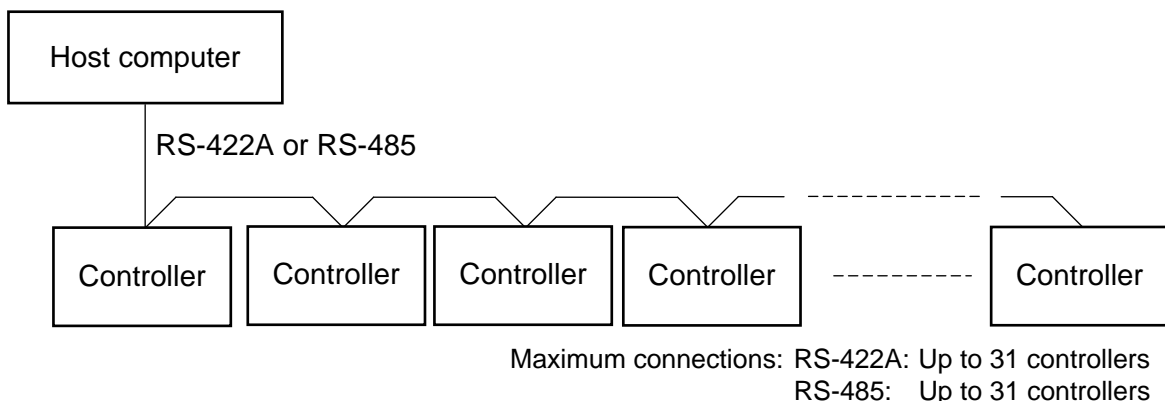

■ Point-to-point connection

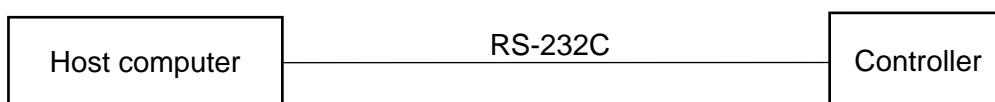

2. SPECIFICATIONS

■ RKC communication

Interface:	FB100: Based on RS-485, EIA standard (Communication 1 and communication 2)
	FB400/900:
	Communication 1: Based on RS-422A, EIA standard Based on RS-485, EIA standard Based on RS-232C, EIA standard
	Communication 2: Based on RS-485, EIA standard Specify the Communication 1 and Communication 2 separately when ordering. However, when Communication 1 is used for RS-422A, no Communication 2 can be used.
Connection method:	RS-422A: 4-wire system, half-duplex multi-drop connection RS-485: 2-wire system, half-duplex multi-drop connection RS-232C: 3-wire system, point-to-point connection
Synchronous method:	Start/Stop synchronous type
Communication speed:	2400 bps, 4800 bps, 9600 bps, 19200 bps, 38400 bps
Data bit configuration:	Start bit: 1 Data bit: 7 or 8 Parity bit: Without, Odd or Even Stop bit: 1 or 2
Protocol:	ANSI X3.28-1976 subcategories 2.5 and A4 RKC communication protocol Polling/Selecting type
Error control:	Vertical parity (With parity bit selected) Horizontal parity (BCC check)
Communication code:	ASCII 7-bit code
Termination resistor:	Externally terminal connected (RS-485)
Xon/Xoff control:	None
Maximum connections:	RS-422A: Up to 31 controllers RS-485: Up to 31 controllers RS-232C: 1 controller
Signal logic:	RS-422A, RS-485

Signal voltage	Logic
$V(A) - V(B) \geq 2\text{ V}$	0 (SPACE)
$V(A) - V(B) \leq -2\text{ V}$	1 (MARK)

Voltage between V (A) and V (B) is the voltage of (A) terminal for the (B) terminal.

RS-232C

Signal voltage	Logic
+3 V or more	0 (SPACE)
-3 V or less	1 (MARK)

■ Modbus

Interface:	FB100: Based on RS-485, EIA standard (Communication 1 and Communication 2)
	FB400/900: Communication 1: Based on RS-422A, EIA standard Based on RS-485, EIA standard Based on RS-232C, EIA standard
	Communication 2: Based on RS-485, EIA standard Specify the Communication 1 and Communication 2 separately when ordering. However, when Communication 1 is used for RS-422A, no Communication 2 can be used.
Connection method:	RS-422A: 4-wire system, half-duplex multi-drop connection RS-485: 2-wire system, half-duplex multi-drop connection RS-232C: 3-wire system, point-to-point connection
Synchronous method:	Start/Stop synchronous type
Communication speed:	2400 bps, 4800 bps, 9600 bps, 19200 bps, 38400 bps
Data bit configuration:	Start bit: 1 Data bit: 8 Parity bit: Without, Odd or Even Stop bit: 1 or 2
Protocol:	Modbus
Signal transmission mode:	Remote Terminal Unit (RTU) mode
Function code:	03H (Read holding registers) 06H (Preset single register) 08H (Diagnostics: loopback test) 10H (Preset multiple registers)
Error check method:	CRC-16
Error code:	1: Function code error 2: When the mismatched address is specified. 3: When the specified number of data items in the query message exceeds the maximum number of data items available 4: Self-diagnostic error response
Termination resistor:	Externally terminal connected (RS-485)
Maximum connections:	RS-422A: Up to 31 controllers RS-485: Up to 31 controllers RS-232C: 1 controller

Signal logic:

RS-422A, RS-485

Signal voltage	Logic
$V(A) - V(B) \geq 2\text{ V}$	0 (SPACE)
$V(A) - V(B) \leq -2\text{ V}$	1 (MARK)

Voltage between V (A) and V (B) is the voltage of (A) terminal for the (B) terminal.

RS-232C

Signal voltage	Logic
+3 V or more	0 (SPACE)
-3 V or less	1 (MARK)

3. WIRING



WARNING

To prevent electric shock or instrument failure, turn off the power before connecting or disconnecting the instrument and peripheral equipment.

3.1 Connect the Communication 1

■ Connection to the RS-485 port of the host computer (master)

● Communication terminal number and signal details

Terminal No.		Signal name	Symbol
FB100	FB400/900		
13	25	Signal ground	SG
14	26	Send/Receive data	T/R (A)
15	27	Send/Receive data	T/R (B)

● Wiring example [FB400/900] (Connections are similar for the FB100)

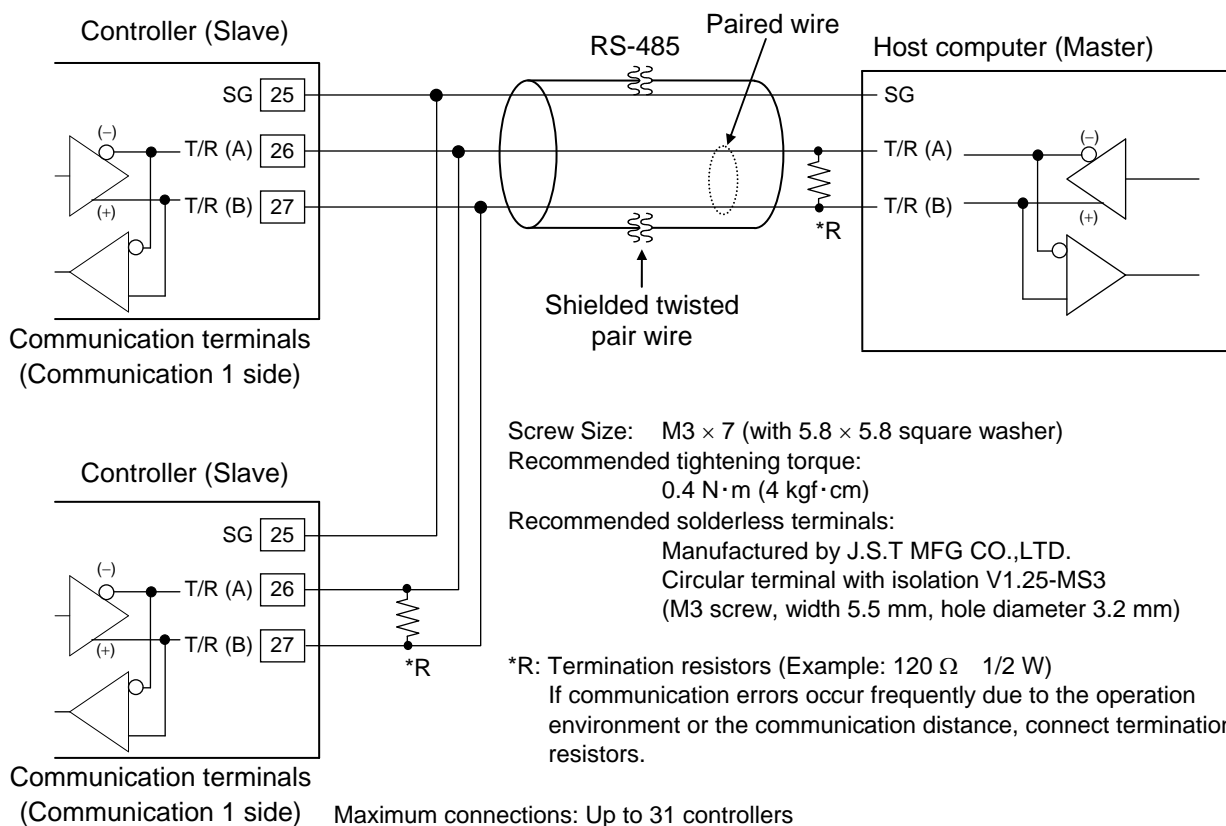

The cable and termination resistor(s) must be provided by the customer.



For FB100 connections when Communication 1 is used for Intercontroller communication, refer to the separate **FB100 Instruction Manual (IMR01W16-E□)**.

■ Connection to the RS-422A port of the host computer (master)

● Communication terminal number and signal details (FB400/900)

Terminal No.	Signal name	Symbol
25	Signal ground	SG
26	Send data	T (A)
27	Send data	T (B)
28	Receive data	R (A)
29	Receive data	R (B)

● Wiring example

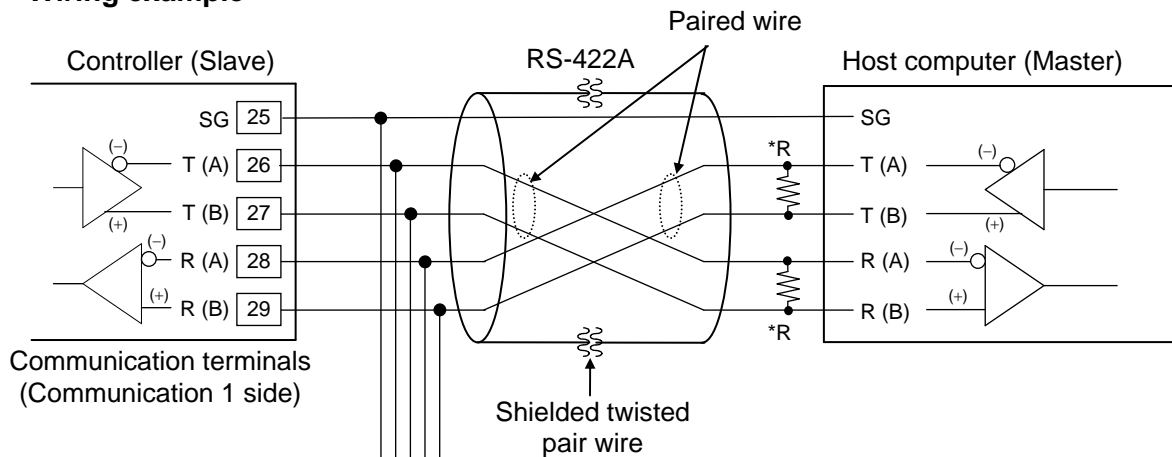

Communication terminals
(Communication 1 side)

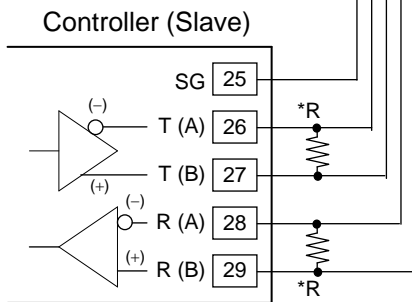

Communication terminals
(Communication 1 side)

Maximum connections: Up to 31 controllers

Screw Size: M3 × 7 (with 5.8 × 5.8 square washer)

Recommended tightening torque:

0.4 N·m (4 kgf·cm)

Recommended solderless terminals:

Manufactured by J.S.T MFG CO.,LTD.

Circular terminal with isolation V1.25-MS3

(M3 screw, width 5.5 mm, hole diameter 3.2 mm)

*R: Termination resistors (Example: 120 Ω 1/2 W)

If communication errors occur frequently due to the operation environment or the communication distance, connect termination resistors.



The cable and termination resistor(s) must be provided by the customer.

■ Connection to the RS-232C port of the host computer (master)

(1) Connection to the RS-232C port of the controller (slave)

● Communication terminal number and signal details (FB400/900)

Terminal No.	Signal name	Symbol
25	Signal ground	SG (GND)
26	Send data	SD (TXD)
27	Receive data	RD (RXD)

● Wiring example

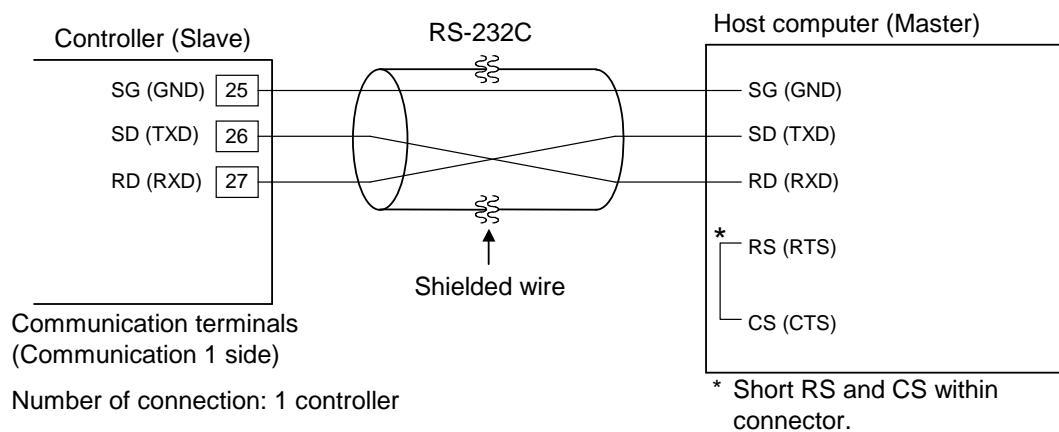

Screw Size: M3 × 7 (with 5.8 × 5.8 square washer)

Recommended tightening torque:

0.4 N·m (4 kgf·cm)

Recommended solderless terminals:

Manufactured by J.S.T MFG CO.,LTD.

Circular terminal with isolation V1.25-MS3

(M3 screw, width 5.5 mm, hole diameter 3.2 mm)



The cable is provided by the customer.

(2) Connection to the RS-485 port of the controller (slave)

Use a RS-232C/RS-485 converter with an automatic send/receive transfer function.

● Communication terminal number and signal details

Terminal No.		Signal name	Symbol
FB100	FB400/900		
13	25	Signal ground	SG
14	26	Send/Receive data	T/R (A)
15	27	Send/Receive data	T/R (B)

● Wiring example [FB400/900] (Connections are similar for the FB100)

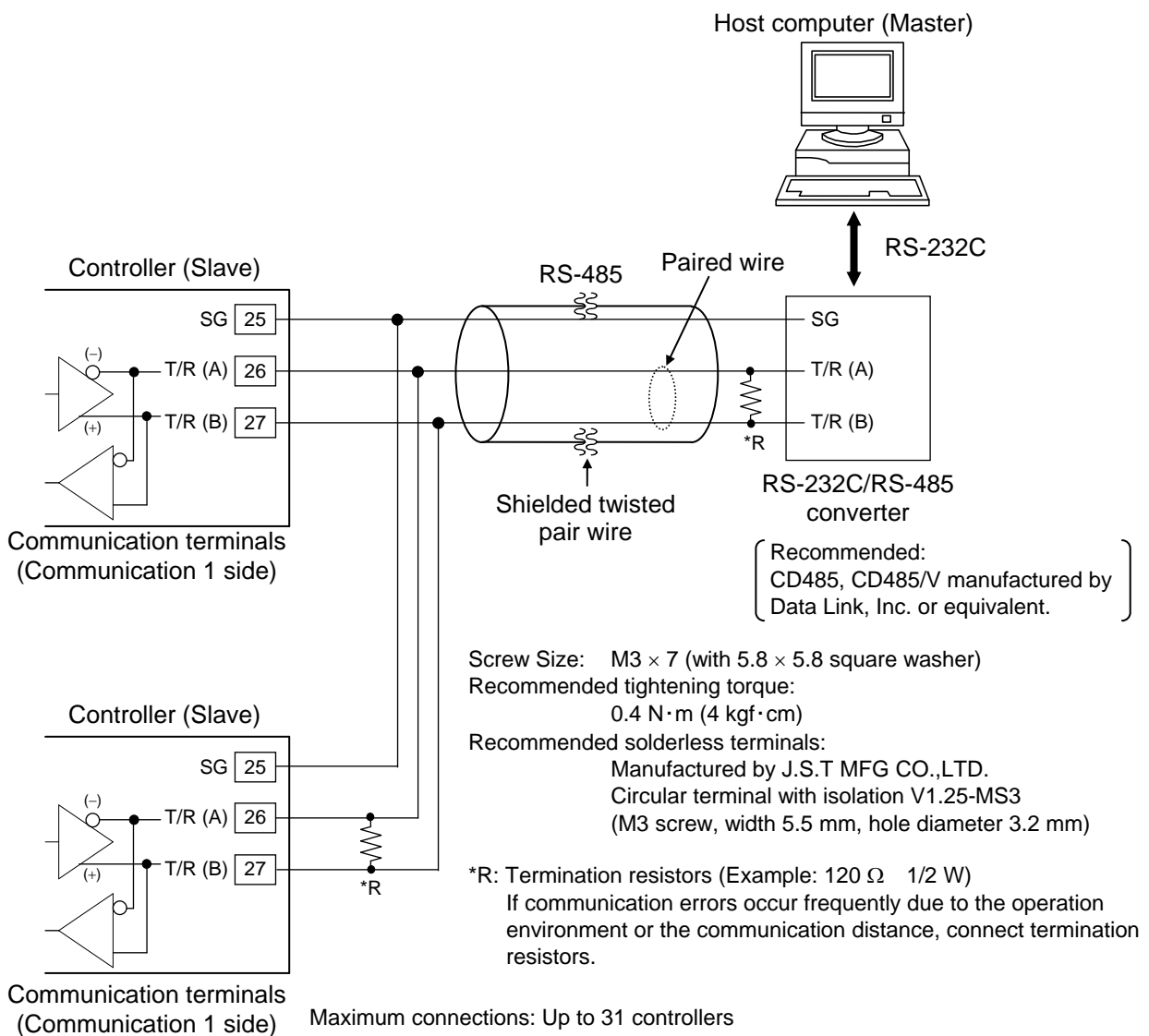

The cable and termination resistor(s) must be provided by the customer.

(3) Connection to the RS-422A port of the controller (slave)

A RS-232C/RS-485 converter is required.

● Communication terminal number and signal details (FB400/900)

Terminal No.	Signal name	Symbol
25	Signal ground	SG
26	Send data	T (A)
27	Send data	T (B)
28	Receive data	R (A)
29	Receive data	R (B)

* Use D-SUB 25-pin modular conversion connector (Recommended type: TM12RV-64-H manufactured by HIROSE ELECTRIC CO., LTD.) when connector of host computer is D-SUB 25-pin.

● Wiring example

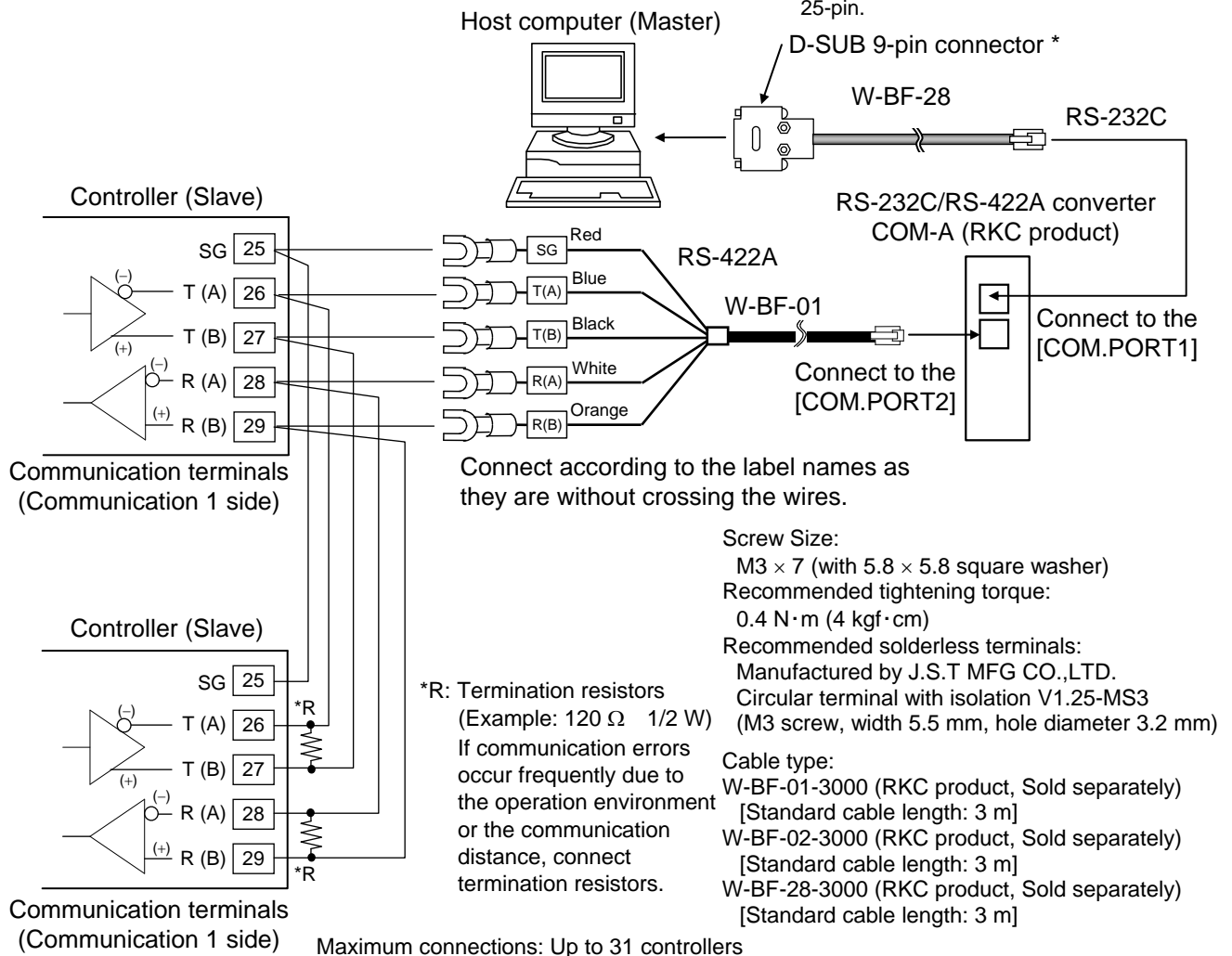

Recommended RS-232C/RS-422A converter: **COM-A** (RKC product)

For the COM-A, refer to the **COM-A/COM-B Instruction Manual (IMSRM33-E□)**.



The cable and termination resistor(s) must be provided by the customer.

■ **Connection to the USB of the host computer (master)**

When the host computer (OS: Windows 2000/XP/Vista/7) is corresponding to the USB connector, our communication converter COM-K (sold separately) can be used.

(1) **Connection to the RS-485 port of the controller (slave)**

● **Communication terminal number and signal details**

Terminal No.		Signal name	Symbol
FB100	FB400/900		
13	25	Signal ground	SG
14	26	Send/Receive data	T/R (A)
15	27	Send/Receive data	T/R (B)

● **Wiring example [FB400/900] (Connections are similar for the FB100)**

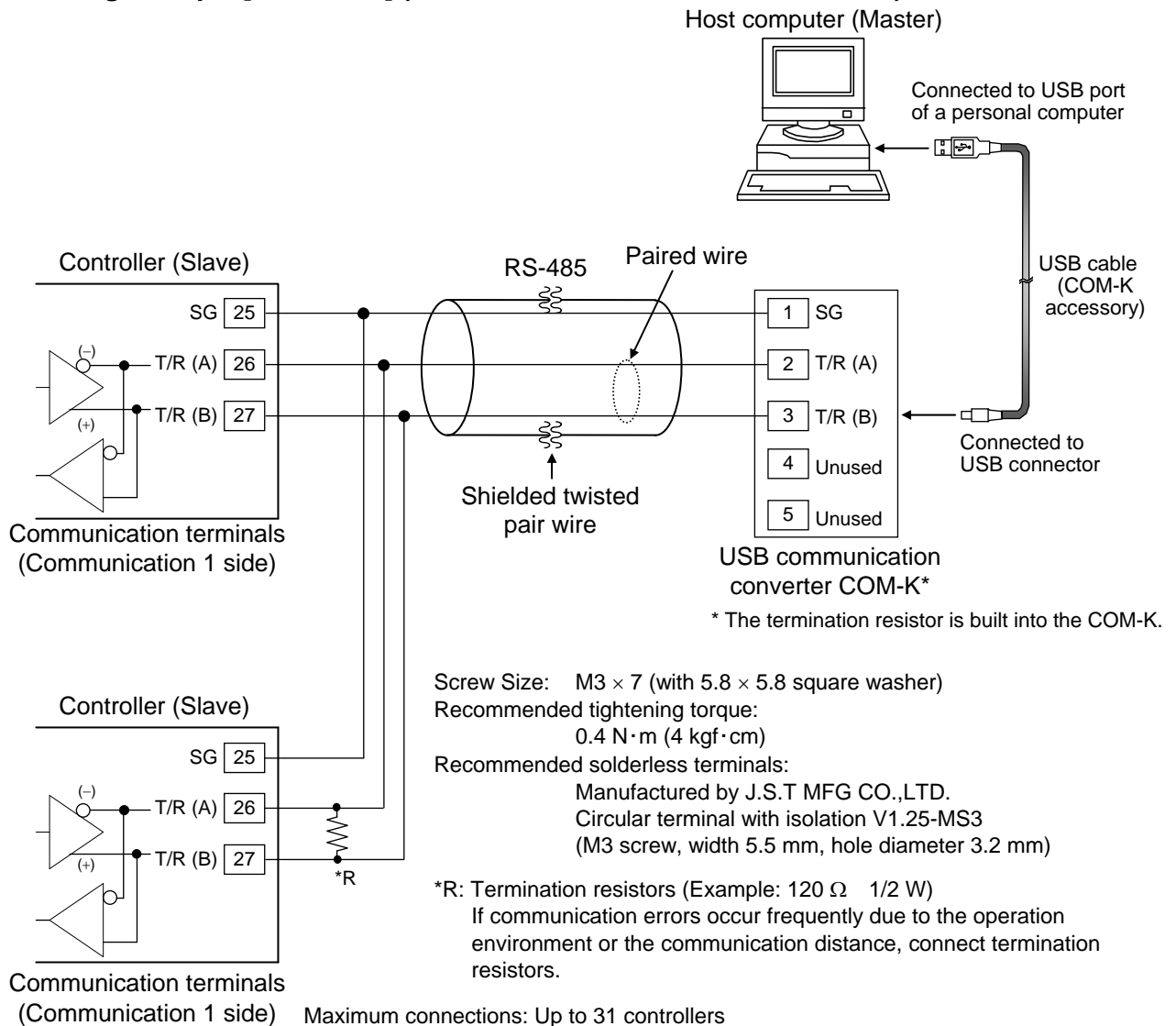

For the COM-K, refer to the **COM-K Instruction Manual (IMR01Z01-E□)**.



The cable and termination resistor(s) must be provided by the customer.

(2) Connection to the RS-422A port of the controller (slave)

● Communication terminal number and signal details (FB400/900)

Terminal No.	Signal name	Symbol
25	Signal ground	SG
26	Send data	T (A)
27	Send data	T (B)
28	Receive data	R (A)
29	Receive data	R (B)

● Wiring example

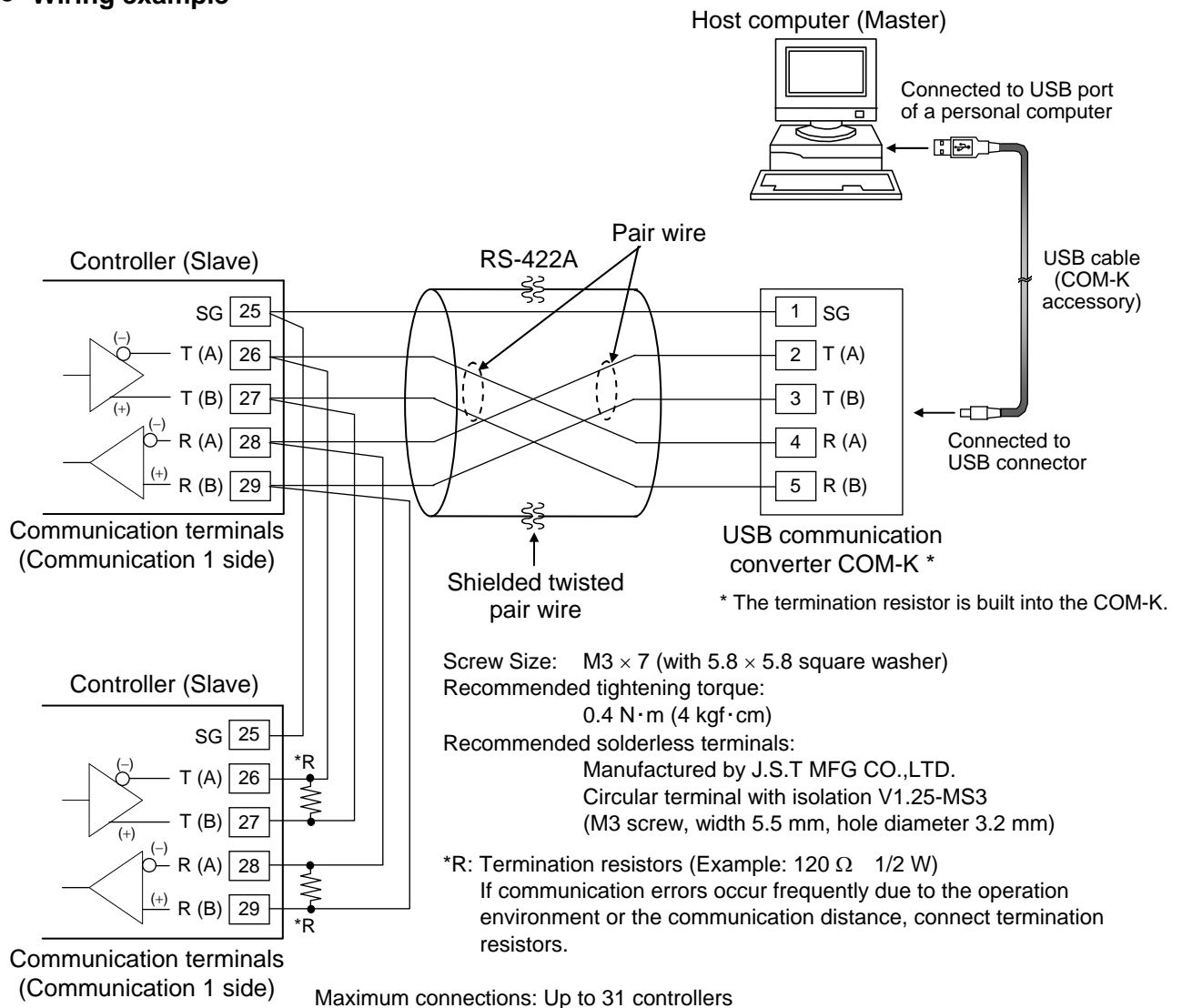

For the COM-K, refer to the **COM-K Instruction Manual (IMR01Z01-E□)**.



The cable and termination resistor(s) must be provided by the customer.

3.2 Connect the Communication 2

Communication 2 is used for Intercontroller communication, but can be also used for Host communication. This section describes the connection method when Communication 2 is used for Host communication. When Communication 2 is used for Host communication, refer to the **Change the protocol of the Communication 2 port (P. 15)**.

-  For the connection method when Communication 2 is used for Intercontroller communication, refer to the **FB100 Instruction Manual (IMR01W16-E□)** or **FB400/FB900 Instruction Manual (IMR01W03-E□)**.

- **Communication 2 interface: RS-485**

- **Communication terminal number and signal details**

Terminal No.		Signal name	Symbol
FB100	FB400/900		
16	25	Signal ground	SG
17	28	Send data/Receive data	T/R (A)
18	29	Send data/Receive data	T/R (B)

- **Wiring method**

For connecting to the host computer, refer to **3.1 Connect the Communication 1 (P. 5)**.

4. SETTING

To establish communication parameters between host computer (master) and controller (slave), it is necessary to set the Device address (Modbus: Slave address), Communication speed, Data bit configuration and Interval time on each controller (slave) in the Setup setting mode.

4.1 Display Sequence

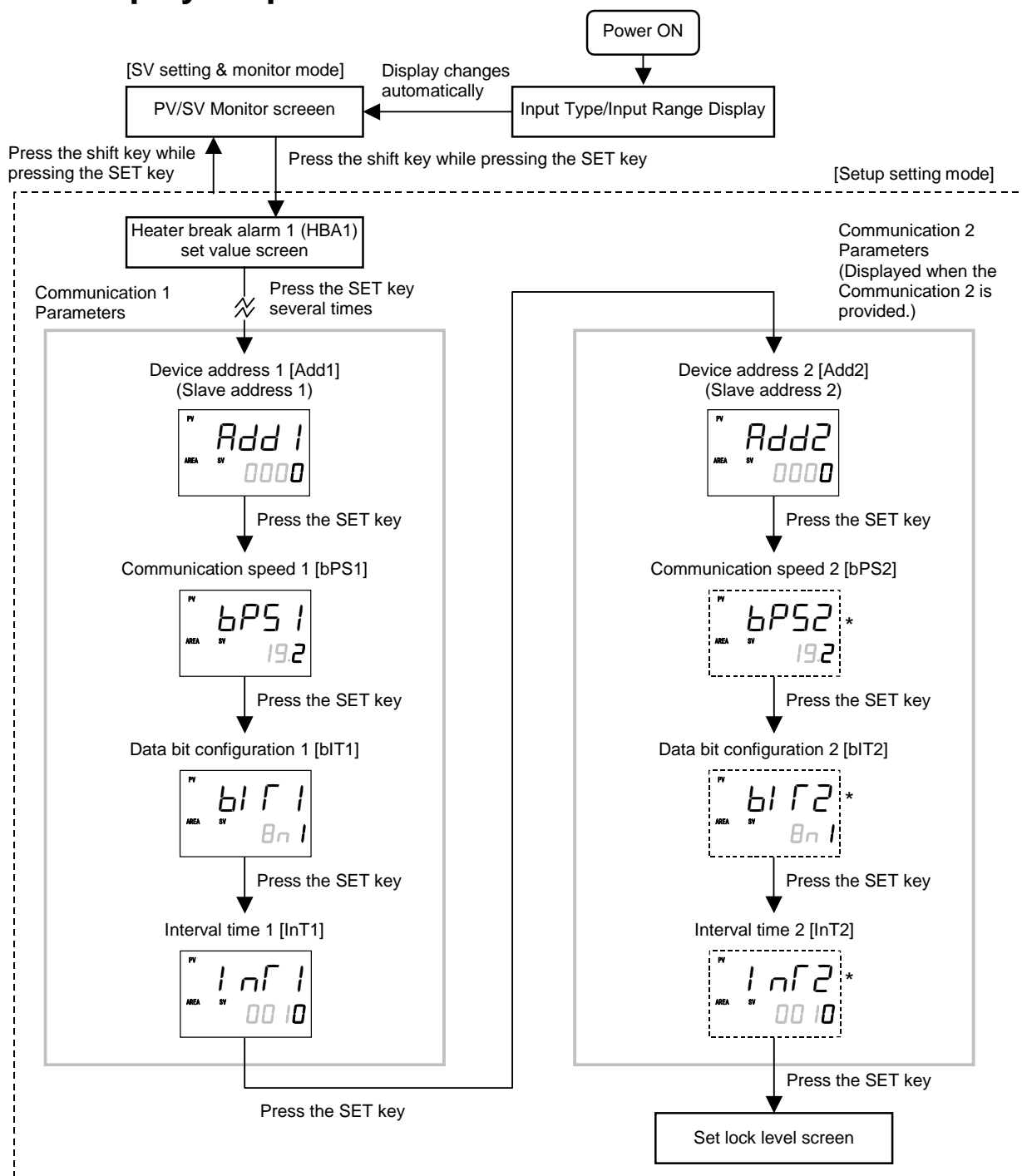

* Displayed only when Communication 2 is used for Host communication. When Communication 2 is used for Host communication, refer to the ■ **Change the protocol of the Communication 2 port (P. 15)**.

4.2 Description of Each Parameter

● Setting of Communication 1 (Displayed when the Communication 1 is provided.)

Symbol	Name	Setting range	Description	Factory set value
Add1 (Add1)	Device address 1 (Slave address 1) Used in Intercontroller communication * and Host communication. *Can only be selected when one-point communication is used on the FB100.	0 to 99	Do not use the same Device address for more than one controller in multi-drop connection. Each controller must have a unique address in multi-drop connection. In Modbus communication, communication is not possible when the address is 0. For Intercontroller communication, set values in consecution starting from 0.	0
bPS1 (bPS1)	Communication speed 1	2.4: 2400 bps 4.8: 4800 bps 9.6: 9600 bps 19.2: 19200 bps 38.4: 38400 bps	Set the same Communication speed for both the controller (slave) and the host computer (master).	19.2
bIT1 (bIT1)	Data bit configuration 1	Refer to Data bit configuration table (P. 15) .	Set the same Data bit configuration for both the controller (slave) and the host computer (master).	8n1
InT1 (InT1)	Interval time 1	0 to 250 ms	The Interval time for the controller should be set to provide a time for host computer to finish sending all data including stop bit and to switch the line to receive status for the host.	10

● Setting of Communication 2 (Displayed when the Communication 2 is provided.)

Symbol	Name	Setting range	Description	Factory set value
Add2 (Add2)	Device address 2 (Slave address 2) For Intercontroller communication or Host communication	0 to 99	Do not use the same Device address for more than one controller in multi-drop connection. Each controller must have a unique address in multi-drop connection. In Modbus communication, communication is not possible when the address is 0. For Intercontroller communication, set device addresses to their corresponding consecutive numbers starting from 0.	0
bPS2 (bPS2)	Communication speed 2 *	Same as the Communication speed 1.		19.2
bIT2 (bIT2)	Data bit configuration 2 *	Same as the Data bit configuration 1.		8n1
InT2 (InT2)	Interval time 2 *	Same as the Interval time 1.		10

* Displayed only when Communication 2 is used for Host communication.

Data bit configuration table

Set value	Data bit	Parity bit	Stop bit
$Bn1$ (8n1)	8	Without	1
$Bn2$ (8n2)	8	Without	2
$BE1$ (8E1)	8	Even	1
$BE2$ (8E2)	8	Even	2
$Bo1$ (8o1)	8	Odd	1
$Bo2$ (8o2)	8	Odd	2
$7n1$ (7n1) ¹	7	Without	1
$7n2$ (7n2) ¹	7	Without	2
$7E1$ (7E1) ¹	7	Even	1
$7E2$ (7E2) ¹	7	Even	2
$7o1$ (7o1) ¹	7	Odd	1
$7o2$ (7o2) ¹	7	Odd	2

Setting range of Modbus

Setting range of RKC communication

¹ When the Modbus communication protocol selected, this setting becomes invalid.



Interval time:

The Interval time for the controller should be set to provide a time for host computer to finish sending all data including stop bit and to switch the line to receive status for the host. If the Interval time between the two is too short, the controller may send data before the host computer is ready to receive it. In this case, communication transmission cannot be conducted correctly.



When the “1: Lock” is selected at the “Lock only setting items other than SV and events (EV1 to EV4)” in the Set lock level (RKC communication: LK, Modbus: 004AH), the communication parameters are not able to change the set values. For the Set lock level, refer to the **FB100 Instruction Manual (IMR01W16-E□)** or **FB400/FB900 Instruction Manual (IMR01W03-E□)**.

■ Change the protocol of the Communication 2 port

When the Communication 2 port is used for Host communication, it is necessary to change the Communication protocol. The Communication protocol is set by “Communication 2 protocol (CMP2, Function block 60)” in Engineering mode.



Parameters in Engineering mode are settable only when the controller is in STOP mode. However, it is possible to check only the data even in RUN mode.



“Communication 1” and “Communication 2” are different from each other in communication speed (refer to P.18). Carefully determine which port to use. If communication volume is large (such as intercontroller communication of PF900), it is recommended to use “Communication 1” which is faster in response speed.





For the transfer to Engineering mode and key operation, refer to the **FB100 Instruction Manual (IMR01W16-E□)** or **FB400/FB900 Instruction Manual (IMR01W03-E□)**.

Engineering mode (Function block 60)

Symbol	Name	Setting range	Description	Factory set value
$CMP2$ (CMP2)	Communication 2 protocol	0: RKC communication 1: Modbus 2: Intercontroller communication	Set the “0: RKC communication” or “1: Modbus” when Communication 2 is used for Host communication.	2

4.3 Setting Procedure Example

-  The first displayed parameter in the Setup setting mode varies depending on the instrument specification. This item describes when the first displayed parameter in the Setup setting mode is the Heater break alarm 1 (HBA1) set value, *HbA1*.
-  Press the SET key to store the new value. If the SET key is not pressed within 1 minute, the display returns to the PV/SV monitor screen and the set value returns the previous setting.
-  After all the communications parameters are set, perform one of the following steps to make settings valid:
 - The power is turned on again after turning it off once.
 - The RUN/STOP mode is changed to RUN from STOP again after changing it to STOP once.

1. Press the Shift key while pressing the SET key at PV/SV monitor screen until Setup setting mode is displayed.

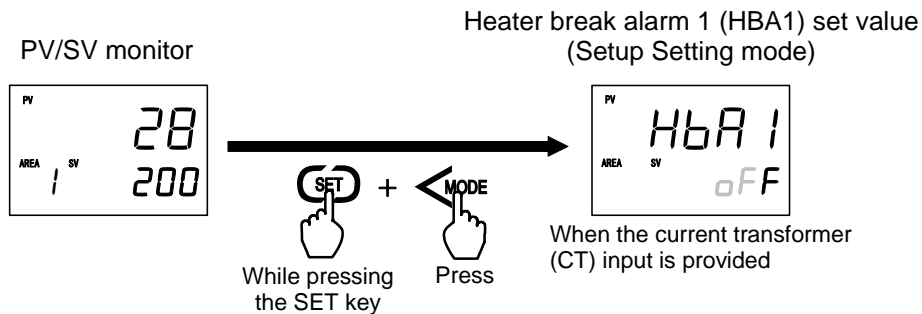

2. Press the SET key several times until Device address 1 setting (slave address 1) screen is displayed. Present set value is displayed, and the least significant digit brightly lit. The high-lighted digit indicates which digit can be set.

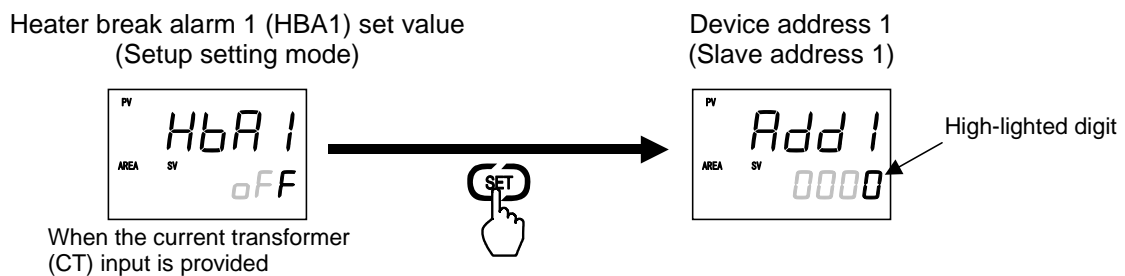

3. Set the Device address 1 (slave address 1). Press the UP key to change the number to 5.
Example: Setting the Device address 1 (slave address 1) to 15.

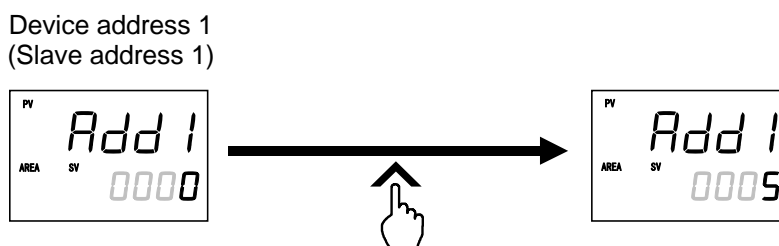

4. Press the shift key to high-light the tens digit, and press the UP key to change the digit to “1.”

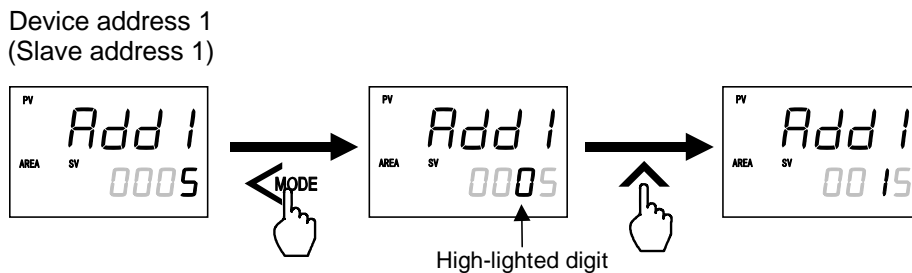

5. Press the SET key to store the new set value. The display goes to the next communication parameter. If the SET key is not pressed within 1 minute, the present display returns to the PV/SV monitor screen and the value set here returns to that before the setting is changed.

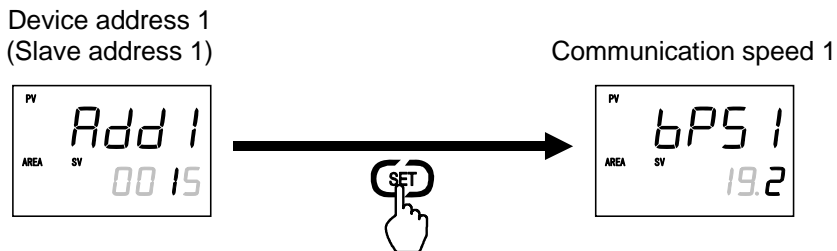

6. Set the Communication speed 1. Press the UP key to select the “38.4.”
Example: Setting the Communication speed 1 to 38400 bps.

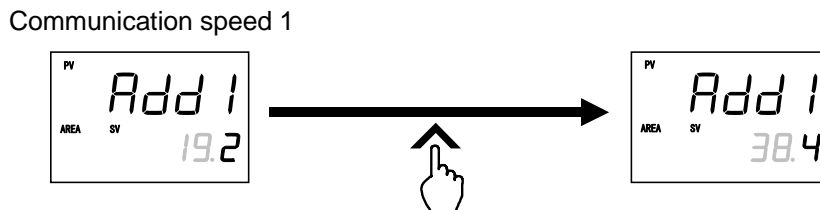

7. Press the SET key to store the new set value. The display goes to the next communication parameter. If the SET key is not pressed within 1 minute, the present display returns to the PV/SV monitor screen and the value set here returns to that before the setting is changed.

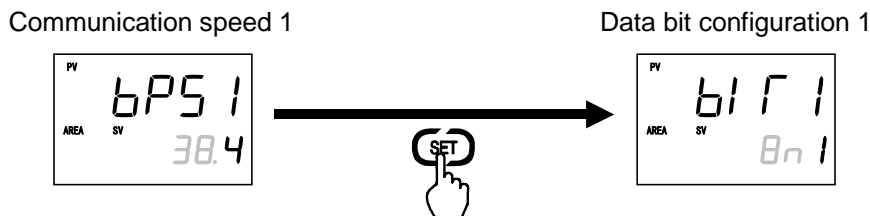

8. Set other communication parameters by the same procedure. After all the communications parameters are set, perform one of the following steps to make settings valid:
- The power is turned on again after turning it off once.
 - The RUN/STOP mode is changed to RUN from STOP again after changing it to STOP once.

 For the RUN/STOP transfer, refer to the **FB100 Instruction Manual (IMR01W16-E□)** or **FB400/FB900 Instruction Manual (IMR01W03-E□)**.

4.4 Communication Requirements

■ Processing times during data send/receive

When the host computer is using either the polling or selecting procedure for communication, the following processing times are required for controller to send data:

- Response wait time after controller sends BCC in polling procedure
- Response wait time after controller sends ACK or NAK in selecting procedure



Response send time is time when Interval time is set at 0 ms.

RKC communication (Polling procedure) processing times (Maximum) [Unit: ms]

Procedure details	Communication 1			Communication 2		
	Min ¹	Typ	Max ²	Min ¹	Typ	Max ²
Response send time after controller receives ENQ	1	2	3	2	20	100
Response send time after controller receives ACK	1	—	3	1	—	100
Response send time after controller receives NAK	1	—	3	1	—	100
Response send time after controller sends BCC	—	—	1	—	—	1

RKC communication (Selecting procedure) processing times (Maximum) [Unit: ms]

Procedure details	Communication 1			Communication 2		
	Min ¹	Typ	Max ²	Min ¹	Typ	Max ²
Response send time after controller receives BCC	2	3	34	3	25	100
Response wait time after controller sends ACK	—	—	1	—	—	1
Response wait time after controller sends NAK	—	—	1	—	—	1

¹ Min of response send time is time at having set Input sampling cycle in 250 ms.

² Max of response send time is time at having set Input sampling cycle in 50 ms.

Modbus processing times (Maximum) [Unit: ms]

Procedure details	Input sampling cycle (ms)	Communication 1			Communication 2		
		250	100	50	250	100	50
Read holding registers [03H] Response transmission time after the slave receives the query message (When 125 registers are collectively read)	FB100	150	380	1380	273	1089	4355
	FB400/900	82	325	1300			
Preset single register [06H] Response transmission time after the slave receives the query message	FB100	28			68		
	FB400/900	28					
Diagnostics (loopback test) [08H] Response transmission time after the slave receives the query message	FB100	4			45		
	FB400/900	1					
Diagnostics (loopback test) [08H] Response transmission time after the slave receives the query message	FB100	150	380	1380	273	1090	4358
	FB400/900	86	343	1370			

■ **RS-485 (2-wire system) send/receive timing (RKC communication)**

RS-485 communication is conducted through two wires, therefore, the transmission and reception of data requires precise timing.

● **Polling procedure**

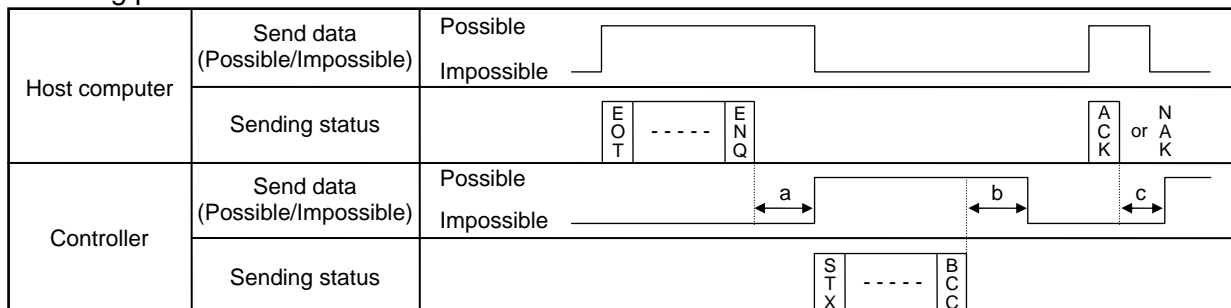

- a: Response send time after the controller receives [ENQ] + Interval time
- b: Response send time after the controller sends BCC
- c: Response send time after the controller receives [ACK] + Interval time or
Response send time after the controller receives [NAK] + Interval time

● **Selecting procedure**

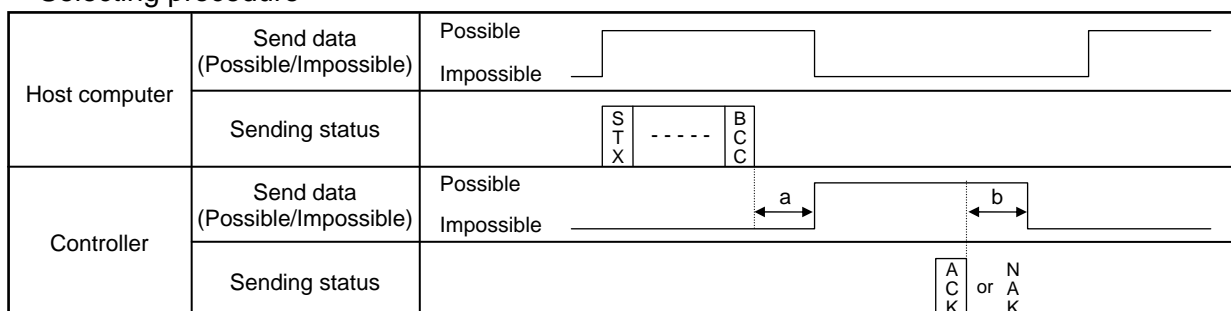

- a: Response send time after the controller receives BCC + Interval time
- b: Response wait time after the controller sends ACK or Response wait time after the controller sends NAK

To switch the host computer from transmission to reception, send data must be on line.

The following processing times are required for the controller to process data:

- In polling procedure, Response wait time after the controller sends BCC
- In selecting procedure, Response wait time after the controller sends ACK or NAK

■ **RS-422A/RS-485 Fail-safe**

A transmission error may occur if the transmission line is disconnected, shorted or set to the high-impedance state. In order to prevent the above error, it is recommended that the fail-safe function be provided on the receiver side of the host computer. The fail-safe function can prevent a framing error from its occurrence by making the receiver output stable to the MARK (1) when the transmission line is in the high-impedance state.

5. RKC COMMUNICATION PROTOCOL

The FB100/400/900 (hereafter, called controller) uses the Polling/Selecting method to establish a data link. The basic procedure is followed ANSI X3.28-1976 subcategories 2.5 and A4 basic mode data transmission control procedure (Fast selecting is the selecting method used in this controller).

- The Polling/Selecting procedures are a centralized control method where the host computer controls the entire process. The host computer initiates all communication so the controller responds according to queries and commands from the host.
- The code use in communication is 7-bit ASCII code including transmission control characters. The transmission control characters are EOT (04H), ENQ (05H), ACK (06H), NAK (15H), STX (02H) and ETX (03H). The figures in the parenthesis indicate the corresponding hexadecimal number.



Data send/receive state of RKC communication can be checked by using the following software:

- Communication monitor tool: WinUCI-A
- Communication setup tool: WinUCI-B for FB series
- Communication tool: PROTEM2

The software can be downloaded from the official RKC website:
<http://www.rkcinst.com/>.

5.1 Polling

Polling is the action where the host computer requests one of the connected controllers to transmit data. An example of the polling procedure is shown below:

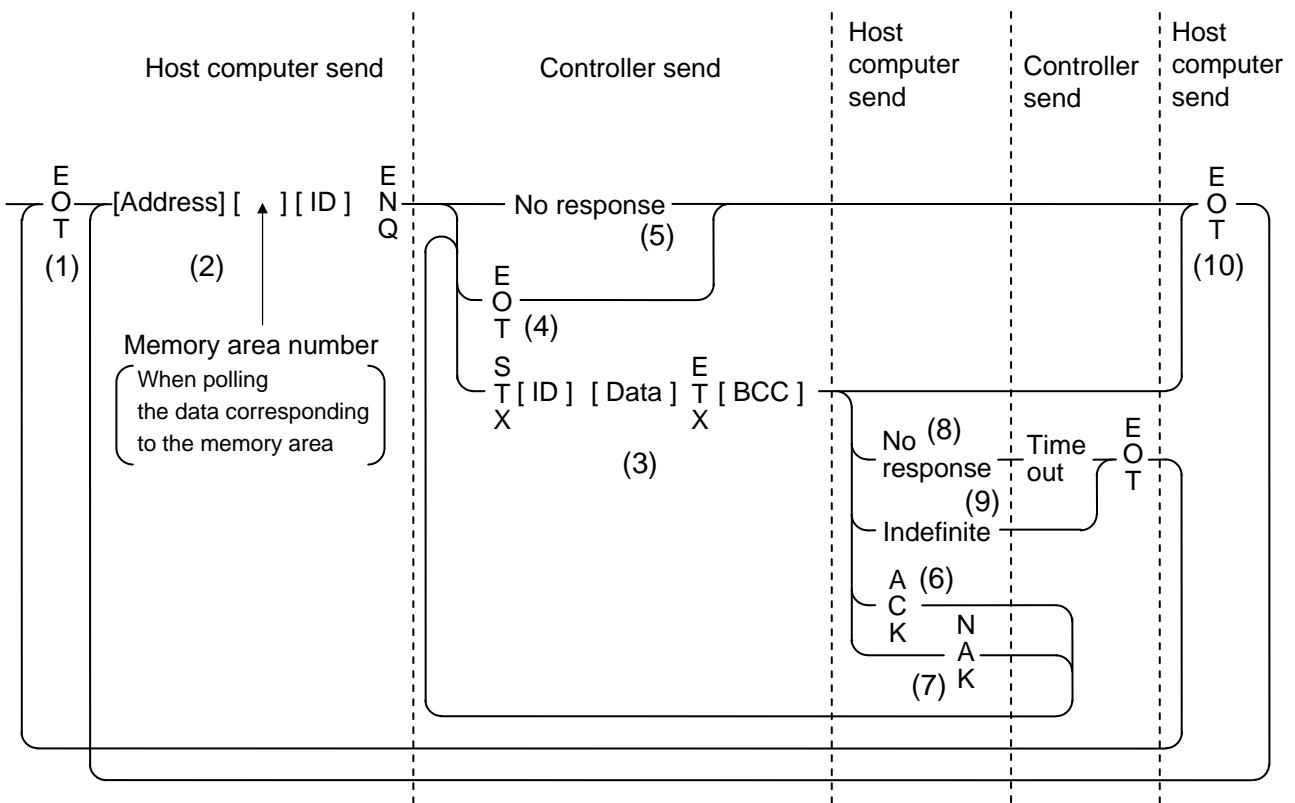

ID: Identifier

5.1.1 Polling procedures

(1) Data link initialization

Host computer sends EOT to the controllers to initiate data link before polling sequence.

(2) Data sent from host computer - Polling sequence

The host computer sends the polling sequence in the following two types of formats:

- Format in which no Memory area number is specified, and
- Format in which the Memory area number is specified.

■ When no Memory area number is specified

To be sent in this format for any identifier not corresponding to the memory area.

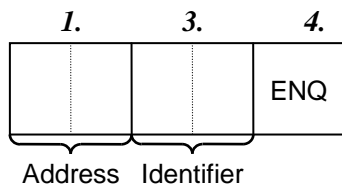

Example:

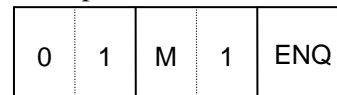

■ When the Memory area number is specified

To be sent in this format for any identifier corresponding to the memory area.

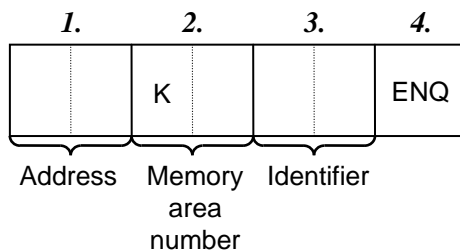

Example:

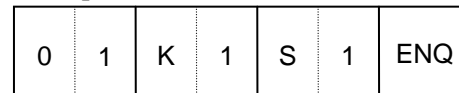

1. Address (2 digits)

The device address specifies the controller to be polled and each controller must have its own unique device address.

This data is a device address of the controller to be selected and must be the same as the device address set value in item **4. SETTING (P. 13)**.



Always specify the device address in RS-232C specification.



The polling address which transmitted a message once becomes effective so long as data link is not initialized by transmit and receive of EOT.

2. Memory area number (2 digits)

This is the identifier to specify the Memory area number. It is expressed by K1 to K8 to each Memory area number (from 1 to 8). If the Memory area number is assigned with K0, this represents that Control area is specified.



The memory area now used for control is called Control area.



If the Memory area number is not specified when polling the identifier corresponding to the memory area, this represents that the Control area is specified.



If any identifier not corresponding to the memory area is assigned with a Memory area number, this Memory area number is ignored.

3. Identifier (2 digits)

The identifier specifies the type of data that is requested from the controller. Always attach the ENQ code to the end of the identifier.



For details, refer to **7. COMMUNICATION DATA LIST (P. 49)**.

4. ENQ

The ENQ is the transmission control character that indicates the end of the polling sequence.

The ENQ must be attached to the end of the identifier.

The host computer then must wait for a response from the controller.

(3) Data sent from the controller

If the polling sequence is received correctly, the controller sends data in the following format:

<i>1.</i>	<i>2.</i>	<i>3.</i>	<i>4.</i>	<i>5.</i>
STX	Identifier	Data	ETX	BCC

1. STX

STX is the transmission control character which indicates the start of the text transmission (identifier and data).

2. Identifier (2 digits)

The identifier indicates the type of data (measured value, status and set value) sent to the host computer.



For details, refer to **7. COMMUNICATION DATA LIST (P. 49)**.

3. Data (7 digits)

Data which is indicated by an identifier of the controller. It is expressed in decimal ASCII code including a minus sign (–) and a decimal point. Data is not zero-suppressed.



Only Model codes (ID), the number of data digits (length) is 32 digits.



Memory area soak time monitor and Area soak time become the following data:

- When data range is 0 hour 00 minute to 99 hours 59 minutes:
Data range is 0:00 to 99:59, punctuation of time unit is expressed in colon “: (3AH).”
- When data range is 0 minute 00 second to 199 minutes 59 seconds:
Data range is 0:00 to 199:59, punctuation of time unit is expressed in colon “: (3AH).”

4. ETX

ETX is a transmission control character used to indicate the end of text transmission.

5. BCC

BCC (Block Check Character) detects error by using horizontal parity (even number).

Calculation method of BCC: *Exclusive OR* all data and characters from STX through ETX, not including STX.

Example:

STX	M	1	0	0	1	0	0	.	0	ETX	BCC
-----	---	---	---	---	---	---	---	---	---	-----	-----

4DH 31H 30H 30H 31H 30H 30H 2EH 30H 03H ← Hexadecimal numbers

$$\text{BCC} = 4\text{DH} \oplus 31\text{H} \oplus 30\text{H} \oplus 30\text{H} \oplus 31\text{H} \oplus 30\text{H} \oplus 30\text{H} \oplus 2\text{EH} \oplus 30\text{H} \oplus 03\text{H} = 50\text{H}$$

(\oplus : *Exclusive OR*)

Value of BCC becomes 50H.

(4) EOT sent from the controller (Ending data transmission from the controller)

In the following cases, the controller sends EOT to terminate the data link:

- When the specified identifier is invalid
- When there is an error in the data type
- When data is not sent from the host computer even if the data link is initialized
- When all the data has been sent

(5) No response from the controller

The controller will not respond if the polling address is not received correctly. It may be necessary for the host computer to take corrective action such as a time-out.

(6) ACK (Acknowledgment)

An acknowledgment ACK is sent by the host computer when data received is correct. When the controller receives ACK from the host computer, the controller will send any remaining data of the next identifier without additional action from the host computer.

☞ For the identifier, refer to **7. COMMUNICATION DATA LIST (P. 49)**.

When host computer determines to terminate the data link, EOT is sent from the host computer.

(7) NAK (Negative acknowledge)

If the host computer does not receive correct data from the controller, it sends a negative acknowledgment NAK to the controller. The controller will re-send the same data when NAK is received. This cycle will go on continuously until either recovery is achieved or the data link is corrected at the host computer.

(8) No response from host computer

When the host computer does not respond within approximately three seconds after the controller sends data, the controller sends EOT to terminate the data link. (Time out: 3 seconds)

(9) Indefinite response from host computer

The controller sends EOT to terminate the data link when the host computer response is indefinite.

(10) EOT (Data link termination)

The host computer sends EOT message when it is necessary to suspend communication with the controller or to terminate the data link due lack of response from the controller.

5.1.2 Polling procedure example

(1) When the monitored items is polled
[Example: Measured value (PV) monitor M1]

■ **Normal transmission**

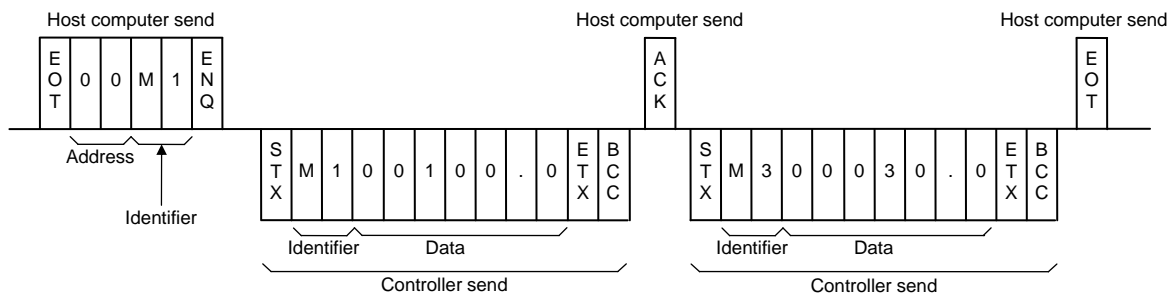

■ **Error transmission**

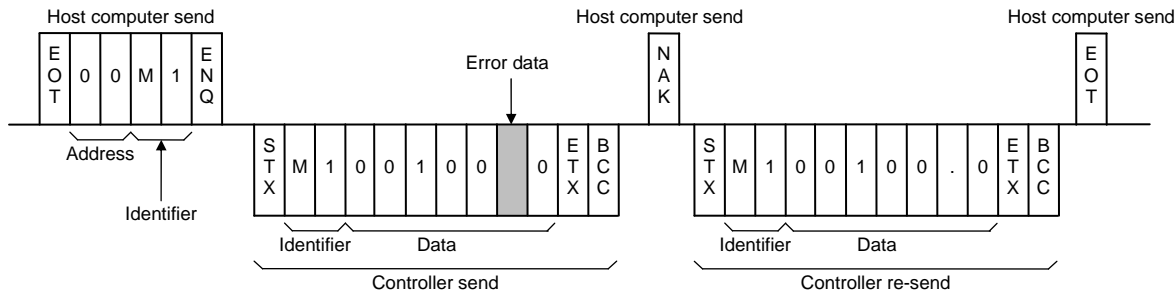

(2) When the items corresponding to the memory area is polled
[Example: Set value (SV) S1]

■ **Normal transmission**

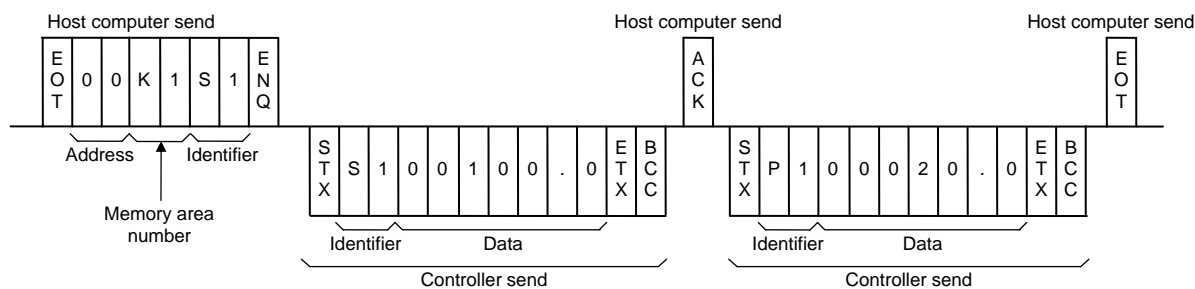

■ **Error transmission**

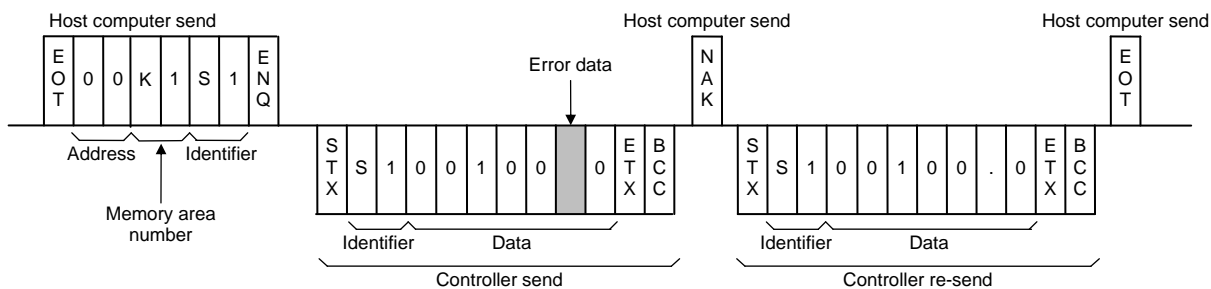

5.2 Selecting

Selecting is the action where the host computer requests one of the connected controllers to receive data. An example of the selecting procedure is shown below:

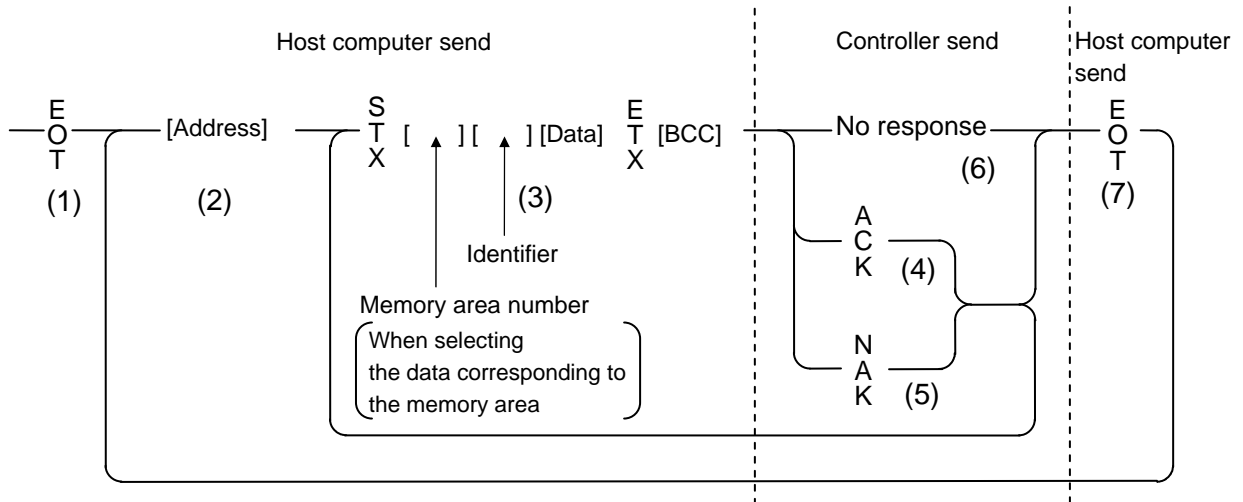

5.2.1 Selecting procedures

(1) Data link initialization

Host computer sends EOT to the controllers to initiate data link before selecting sequence.

(2) Sending selecting address from the host computer

Host computer sends selecting address for the selecting sequence.

■ Address (2 digits)

This data is a device address of the controller to be selected and must be the same as the device address set value in item **4. SETTING (P. 13)**.



Always specify the device address in RS-232C specification.



As long as the data link is not initialized by sending or receiving EOT, the selecting address once sent becomes valid.

(3) Data sent from the host computer

The host computer sends data for the selecting sequence with the following format:

■ When no memory area number is specified

	2.	3.		
STX	Identifier	Data	ETX	BCC

■ When the memory area number is specified

	1.	2.	3.		
STX	Memory area number	Identifier	Data	ETX	BCC

 For the STX, ETX and BCC, refer to **5.1 Polling (P. 20)**.

1. Memory area number (2 digits)

This is the identifier to specify the Memory area number. It is expressed by K1 to K8 to each Memory area number (from 1 to 8). If the Memory area number is assigned with K0 this represents that Control area is specified.



The memory area now used for control is called Control area.



If the Memory area number is not specified when selecting the identifier corresponding to the memory area, selecting is made to the memory area.



If any identifier not corresponding to the memory area is assigned with a Memory area number, this Memory area number is ignored.

2. Identifier (2 digits)

The identifier specifies the type of data that is requested from the controller, such as set value.



For details, refer to **7. COMMUNICATION DATA LIST (P. 49)**.

3. Data

Data which is indicated by an identifier of the controller is expressed in decimal ASCII code including a minus sign (–) and a decimal point. The channel number can be zero-suppressed.

The number of digits varies depending on the type of identifier. (Within 7 digits)



Area soak time set data as the following:

- When data range is 0 hour 00 minute to 99 hours 59 minutes:

Data range is 0:00 to 99:59, punctuation of time unit is expressed in colon “: (3AH).”

- When data range is 0 minute 00 second to 199 minutes 59 seconds:

Data range is 0:00 to 199.59, punctuation of time unit is expressed in colon “: (3AH).”

In addition to above, when minute and second data are set in more than 60, become as the following:

Example: 1:65 (1 hour 65 minutes) → 2:05 (2 hours 05 minutes)

0:65 (0 minute 65 seconds) → 1:05 (1 minute 05 seconds)

- **About numerical data**

- Numerical data which the controller can receive**

- Data with numbers below the decimal point omitted or zero-suppressed data can be received.

(Number of digits: Within 7 digits)

<Example> When data send with -001.5, -01.5, -1.5, -1.50, -1.500 at the time of -1.5, controller can receive data.

- When the host computer sends data containing a decimal point to an item without a decimal point, the controller receives a message rounded down to the nearest whole number.

<Example> When setting range is 0 to 200, the controller will receive as follows:

Send data	0.5	100.5
Receive data	0	100

- The controller receives the value based on the decided number of places after decimal point. Any number beyond the established number of decimal points will be cut off.

<Example> When setting range is -10.00 to +10.00, the controller will receives as follows:

Send data	-.5	-.058	.05	-0
Receive data	-0.50	-0.05	0.05	0.00

- Numerical data which the controller can not receive**

The controller sends NAK when received a following data.

+	Plus sign and the data that gained plus sing
-	Only minus sign (there is no figure)
.	Only decimal point (period)
-.	Only minus sign and decimal point (period)

- (4) ACK (Acknowledgment)**

An acknowledgment ACK is sent by the controller when data received is correct. When the host computer receives ACK from the controller, the host computer will send any remaining data. If there is no more data to be sent to the controller, the host computer sends EOT to terminate the data link.

(5) NAK (Negative acknowledge)

If the controller does not receive correct data from the host computer, it sends a negative acknowledgment NAK to the host computer. Corrections, such as re-send, must be made at the host computer. The controller will send NAK in the following cases:

- When an error occurs on communication the line (parity, framing error, etc.)
- When a BCC check error occurs
- When the specified identifier is invalid
- When receive data exceeds the setting range
- When receive data is the identifier of RO (read only)

(6) No response from controller

The controller does not respond when it can not receive the selecting address, STX, ETX or BCC.

(7) EOT (Data link termination)

The host computer sends EOT when there is no more data to be sent from the host computer or there is no response from the controller.

5.2.2 Selecting procedure example

(1) When the items corresponding to the Control area is selected [Example: Set value (SV) S1]

■ Normal transmission

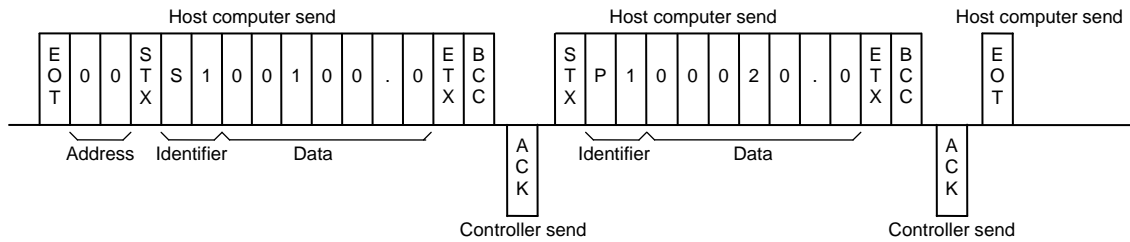

■ Error transmission

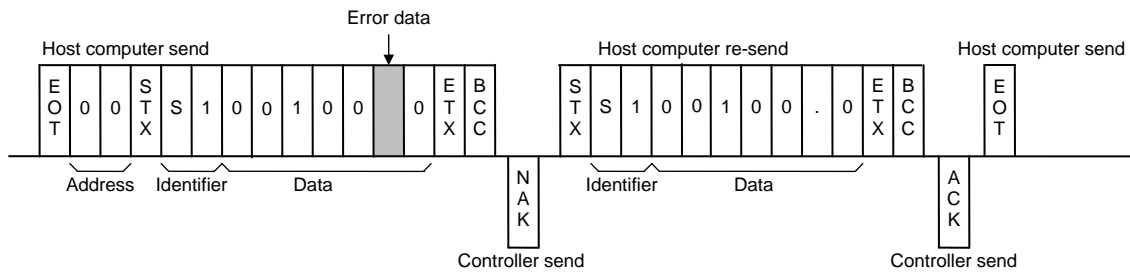

(2) When the items corresponding to the memory area is selected [Example: Set value (SV) S1]

■ Normal transmission

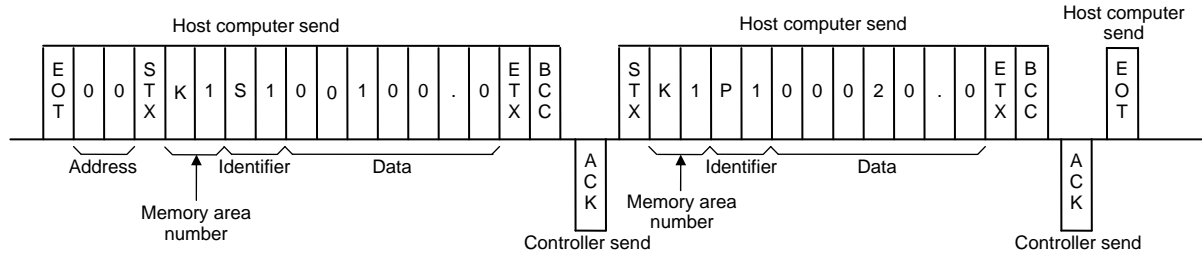

■ Error transmission

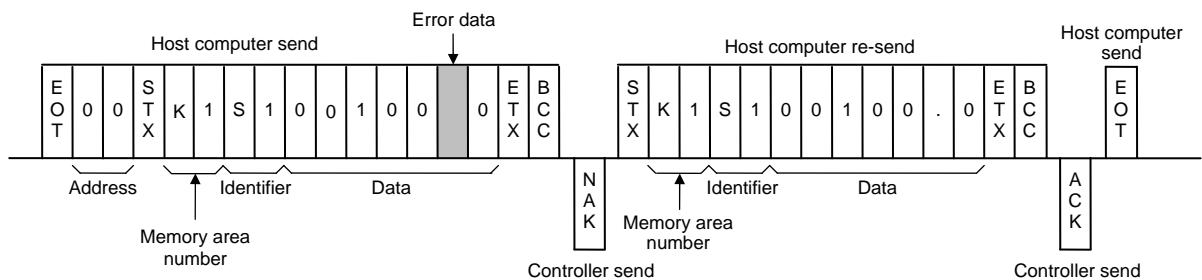

6. MODBUS COMMUNICATION PROTOCOL

The master controls communication between master and slave. A typical message consists of a request (query message) sent from the master followed by an answer (response message) from the slave. When master begins data transmission, a set of data is sent to the slave in a fixed sequence. When it is received, the slave decodes it, takes the necessary action, and returns data to the master.



Data send/receive state of Modbus communication can be checked by using our communication tool “PROTEM2.”

The communication tool “PROTEM2” can be downloaded from the official RKC website:
<http://www.rkcinst.com/>.

6.1 Message Format

The message consists of four parts: slave address, function code, data, and error check code which are always transmitted in the same sequence.

Slave address
Function code
Data
Error check CRC-16

Message format

■ Slave address

The slave address is a number from 1 to 99 manually set at the front key panel of the controller.



For details, refer to **4. SETTING (P. 13)**.

Although all connected slave units receive the query message sent from the master, only the slave with the slave address coinciding with the query message will accept the message.

■ Function code

The function codes are the instructions set at the master and sent to the slave describing the action to be executed. The function codes are included when the slave responds to the master.



For details, refer to **6.2 Function Code (P. 32)**.

■ Data

The data to execute the function specified by the function code is sent to the slave and corresponding data returned to the master from the slave.



For details, refer to **6.6 Register Read and Write (P. 37)**, **6.7 Data Configuration (P. 41)** and **7. COMMUNICATION DATA LIST (P. 49)**.

■ Error check

An error checking code (CRC-16: Cyclic Redundancy Check) is used to detect an error in the signal transmission.



For details, refer to **6.5 Calculating CRC-16 (P. 34)**.

6.2 Function Code

Function code contents

Function code (Hexadecimal)	Function	Contents
03H	Read holding registers	Measured value, control output value, current transformer input measured value, Event status, etc.
06H	Preset single register	Set value, PID constants, event set value, etc.
08H	Diagnostics (loopback test)	Loopback test
10H	Preset multiple registers	Set value, PID constants, event set value, etc.

Message length of each function (Unit: byte)

Function code (Hexadecimal)	Function	Query message		Response message	
		Min	Max	Min	Max
03H	Read holding registers	8	8	7	255
06H	Preset single register	8	8	8	8
08H	Diagnostics (loopback test)	8	8	8	8
10H	Preset multiple registers	11	255	8	8

6.3 Communication Mode

Signal transmission between the master and slaves is conducted in Remote Terminal Unit (RTU) mode.

Items	Contents
Data bit length	8-bit (Binary)
Start mark of message	Unused
End mark of message	Unused
Message length	Refer to 6.2 Function code
Data time interval	Less than 24-bit time *
Error check	CRC-16 (Cyclic Redundancy Check)

* When sending a command message from the master, set intervals of data configuring one message to time shorter than the 24-bit time. If time intervals become time longer than the 24-bit time the relevant slave assumes that message sending from the master is terminated and there is no response.

6.4 Slave Responses

(1) Normal response

- In the response message of the Read Holding Registers, the slave returns the read out data and the number of data items with the same slave address and function code as the query message.
- In the response message of the Preset Single Register, the slave returns the same message as the query message.
- In the response message of the Diagnostics (Loopback test), the slave returns the same message as the query message.
- In the response message of the Preset Multiple Registers, the slave returns the slave address, the function code, starting number, and number of holding registers in the multi-query message.

(2) Defective message response

- If the query message from the master is defective, except for transmission error, the slave returns the error response message without any action.
- If the self-diagnostic function of the slave detects an error, the slave will return an error response message to all query messages.
- The function code of each error response message is obtained by adding 80H to the function code of the query message.

Slave address
Function code
Error code
Error check CRC-16

Error response message

Error code	Contents
1	Function code error (An unsupported function code was specified)
2	When the mismatched address is specified.
3	When the specified number of data items in the query message exceeds the maximum number of data items available
4	Self-diagnostic error response

(3) No response

The slave ignores the query message and does not respond when:

- The slave address in the query message does not coincide with any slave address settings.
- The CRC code of the master does not coincide with that of the slave.
- Transmission error such as overrun, framing, parity and etc., is found in the query message.
- Data time interval in the query message from the master exceeds 24-bit time. *
- Transfer from STOP to RUN was performed by key operation during communication. *

* When this case is operated, there is when the slave does not sometimes make a response.

6.5 Calculating CRC-16

The Cyclic Redundancy Check (CRC) is a 2 byte (16-bit) error check code. After constructing the data message, not including start, stop, or parity bit, the master calculates a CRC code and appends this to the end of the message. The slave will calculate a CRC code from the received message, and compare it with the CRC code from the master. If they do not coincide, a communication error has occurred and the slave does not respond.

The CRC code is formed in the following sequence:

1. Load FFFFH to a 16-bit CRC register.
2. *Exclusive OR* (\oplus) the first byte (8 bits) of the message with the CRC register. Return the result to the CRC register.
3. Shift the CRC register 1 bit to the right.
4. If the carry flag is 1, *exclusive OR* the CRC register with A001 hexadecimal and return the result to the CRC register. If the carry flag is 0, repeat step 3.
5. Repeat step 3 and 4 until there have been 8 shifts.
6. *Exclusive OR* the next byte (8 bits) of the message with the CRC register.
7. Repeat step 3 through 6 for all bytes of the message (except the CRC).
8. The CRC register contains the 2 byte CRC error code. When they are appended to the message, the low-order byte is appended first, followed by the high-order byte.

■ The flow chart of CRC-16

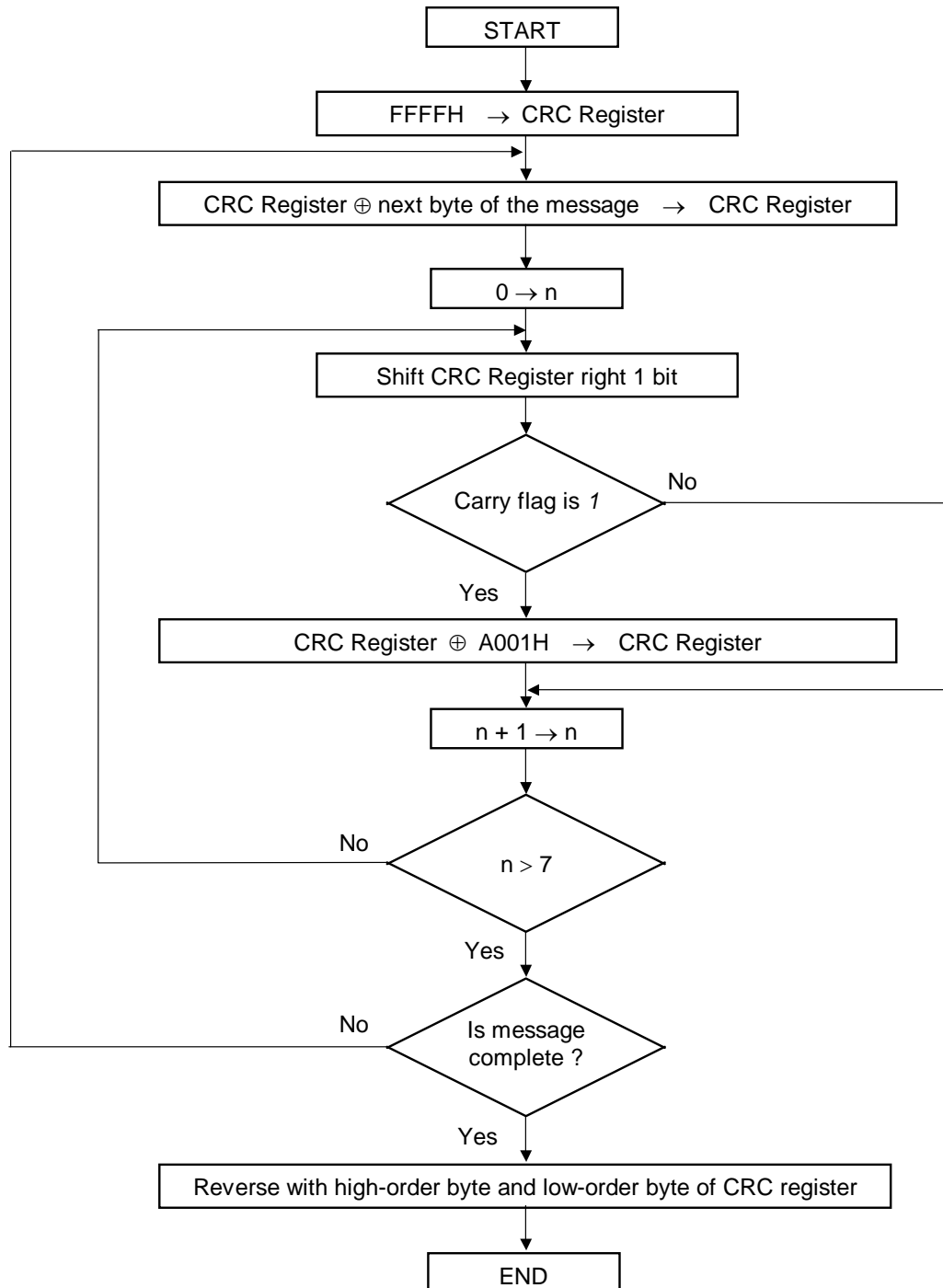

The \oplus symbol indicates an *exclusive OR* operation. The symbol for the number of data bits is n .

■ Example of a CRC calculation in the 'C' language

This routine assumes that the data types 'uint16' and 'uint8' exists. These are unsigned 16-bit integer (usually an 'unsigned short int' for most compiler types) and unsigned 8-bit integer (unsigned char). 'z_p' is a pointer to a Modbus message, and 'z_messaage_length' is its length, excluding the CRC. Note that the Modbus message will probably contain NULL characters and so normal C string handling techniques will not work.

```
uint16 calculate_crc (byte *z_p, uint16 z_message_length)

/* CRC runs cyclic Redundancy Check Algorithm on input z_p */
/* Returns value of 16 bit CRC after completion and */
/* always adds 2 crc bytes to message */
/* returns 0 if incoming message has correct CRC */

{
    uint16 CRC= 0xffff;
    uint16 next;
    uint16 carry;
    uint16 n;
    uint8 crch, crcl;

    while (z_messaage_length--) {
        next = (uint16) *z_p;
        CRC ^= next;
        for (n = 0; n < 8; n++) {
            carry = CRC & 1;
            CRC >>= 1;
            if (carry) {
                CRC ^= 0xA001;
            }
        }
        z_p++;
    }
    crch = CRC / 256;
    crcl = CRC % 256
    z_p [z_messaage_length++] = crcl;
    z_p [z_messaage_length] = crch;
    return CRC;
}
```

6.6 Register Read and Write

6.6.1 Read holding registers [03H]

The query message specifies the starting register address and quantity of registers to be read.

The contents of the holding registers are entered in the response message as data, divided into two parts: the high-order 8-bit and the low-order 8-bit, arranged in the order of the register numbers.

Example: The contents of the four holding registers from 0000H to 0003H are the read out from slave address 2.

Query message

Slave address		02H	
Function code		03H	
Starting No.	High	00H	} First holding register address
	Low	00H	
Quantity	High	00H	} The setting must be between 1 (0001H) and 125 (007DH).
	Low	04H	
CRC-16	High	44H	
	Low	3AH	

Normal response message

Slave address		02H	
Function code		03H	
Number of data		08H	→ Number of holding registers × 2
First holding register contents	High	00H	
	Low	19H	
Next holding register contents	High	00H	
	Low	00H	
Next holding register contents	High	00H	
	Low	19H	
Next holding register contents	High	00H	
	Low	00H	
CRC-16	High	C3H	
	Low	95H	

Error response message

Slave address		02H
80H + Function code		83H
Error code		03H
CRC-16	High	F1H
	Low	31H

6.6.2 Preset single register [06H]

The query message specifies data to be written into the designated holding register. The write data is arranged in the query message with high-order 8-bit first and low-order 8-bit next. Only R/W holding registers can be specified.

Example: Data is written into the holding register 0049H of slave address 1.

Query message

Slave address		01H
Function code		06H
Holding register number	High	00H
	Low	49H
Write data	High	00H
	Low	64H
CRC-16	High	59H
	Low	F7H

} Any data within the range

Normal response message

Slave address		01H
Function code		06H
Holding register number	High	00H
	Low	49H
Write data	High	00H
	Low	64H
CRC-16	High	59H
	Low	F7H

} Contents will be the same as query message data.

Error response message

Slave address		01H
80H + Function code		86H
Error code		02H
CRC-16	High	C3H
	Low	A1H

6.6.3 Diagnostics (Loopback test) [08H]

The master's query message will be returned as the response message from the slave.

This function checks the communication system between the master and slave (the controller).

Example: Loopback test for slave address 1

Query message

Slave address		01H	
Function code		08H	
Test code	High	00H	} Test code must be set to 00.
	Low	00H	
Data	High	1FH	} Any pertinent data
	Low	34H	
CRC-16	High	E9H	
	Low	ECH	

Normal response message

Slave address		01H	} Contents will be the same as query message data.
Function code		08H	
Test code	High	00H	
	Low	00H	
Data	High	1FH	
	Low	34H	
CRC-16	High	E9H	
	Low	ECH	

Error response message

Slave address		01H
80H + Function code		88H
Error code		03H
CRC-16	High	06H
	Low	01H

6.6.4 Preset multiple registers [10H]

The query message specifies the starting register address and quantity of registers to be written. The write data is arranged in the query message with high-order 8-bit first and low-order 8-bit next. Only R/W holding registers can be specified.

Example: Data is written into the two holding registers from 0048H to 0049H of slave address 1.

Query message

Slave address		01H	
Function code		10H	
Starting number	High	00H	} First holding register address
	Low	48H	
Quantity	High	00H	} The setting must be between 1 (0001H) and 123 (007BH).
	Low	02H	
Number of data		04H	→ Number of holding registers × 2
Data to first register	High	00H	} Any pertinent data
	Low	64H	
Data to next register	High	00H	
	Low	00H	
CRC-16	High	B7H	
	Low	E6H	

Normal response message

Slave address		01H
Function code		10H
Starting number	High	00H
	Low	48H
Quantity	High	00H
	Low	02H
CRC-16	High	C1H
	Low	DEH

Error response message

Slave address		01H
80H + Function code		90H
Error code		02H
CRC-16	High	CDH
	Low	C1H

6.7 Data Configuration

6.7.1 Data scale

The numeric range of data used in Modbus protocol is 0000H to FFFFH. Only the set value within the setting range is effective.



FFFFH represents -1.

■ Data processing with decimal points

The Modbus protocol does not recognize data with decimal points during communication.

● Data with one decimal place

Current transformer 1 (CT1) input value monitor
 Current transformer 2 (CT2) input value monitor
 Manipulated output value (MV1) monitor [heat-side]
 Manipulated output value (MV2) monitor [cool-side]
 Holding peak value ambient temperature monitor
 Power feed forward input value monitor *
 Manual reset
 Heater break alarm 1 (HBA1) set value
 Heater break determination point 1
 Heater melting determination point 1
 Heater break alarm 2 (HBA2) set value
 Heater break determination point 2
 Heater melting determination point 2
 PV digital filter
 RS digital filter
 Proportional cycle time [heat-side]
 Proportional cycle time [cool-side]
 Timer 1
 Timer 2
 Timer 3
 Timer 4
 Event 1 delay timer
 Event 2 delay timer
 Event 3 delay timer
 Event 4 delay timer

* FB400/900

Derivative gain
 Manipulated output value at input error
 Manipulated output value (MV1) at STOP mode [heat-side]
 Manipulated output value (MV2) at STOP mode [cool-side]
 Output change rate limiter (up) [MV1]
 Output change rate limiter (down) [MV1]
 Output limiter high (MV1)
 Output limiter low (MV1)
 Output change rate limiter (up) [MV2]
 Output change rate limiter (down) [MV2]
 Output limiter high (MV2)
 Output limiter low (MV2)
 Overlap/Deadband reference point
 Output value with AT turned on
 Output value with AT turned off
 AT differential gap time
 Open/Close output neutral zone
 Open/Close output differential gap
 Integrated output limiter
 Automatic temperature rise dead time
 Automatic temperature rise gradient data

Example: When Manipulated output value (MV1) monitor [heat-side] is 5.0 %, 5.0 is processed as 50,
 50 = 0032H

Manipulated output value (MV1) monitor [heat-side]	High	00H
	Low	32H

● **Data with two decimal places**

- | | |
|--|--|
| PV low input cut-off | Proportional band adjusting factor [cool-side] |
| Power feed forward gain * | Integral time adjusting factor [cool-side] |
| Area soak time 1 | Derivative time adjusting factor [cool-side] |
| Proportional band adjusting factor [heat-side] | ST proportional band adjusting factor |
| Integral time adjusting factor [heat-side] | ST integral time adjusting factor |
| Derivative time adjusting factor [heat-side] | ST derivative time adjusting factor |
- * FB400/900

Example: When PV low input cut-off is 0.55 second, 0.55 is processed as 55,
55 = 0037H

PV low input cut-off	High	00H
	Low	37H

● **Data with three decimal places**

- PV ratio
- RS ratio
- Undershoot suppression factor

Example: When PV ratio is 0.555, 0.555 is processed as 555,
555 = 022BH

PV ratio	High	02H
	Low	2BH

● **Data whose decimal point's presence and/or position depends on Integral/Derivative time decimal point position (0098H) selection**

The position of the decimal point changes depending on the Integral/Derivative time decimal point position selection type, because the Modbus protocol does not recognize data with decimal points during communication.

[Type of decimal points position]

No decimal place, One decimal place

- | | |
|--|--|
| Integral time [heat-side] | Derivative time limiter (high) [heat-side] |
| Derivative time [heat-side] | Derivative time limiter (low) [heat-side] |
| Integral time [cool-side] | Integral time limiter (high) [cool-side] |
| Derivative time [cool-side] | Integral time limiter (low) [cool-side] |
| Integral time limiter (high) [heat-side] | Derivative time limiter (high) [cool-side] |
| Integral time limiter (low) [heat-side] | Derivative time limiter (low) [cool-side] |

Example: When Integral time [heat-side] is 240.0 seconds, 240.0 is processed as 2400,
2400 = 0960H

Integral time [heat-side]	High	09H
	Low	60H

● **Data whose decimal point's presence and/or position depends on Input range and Decimal point position (0054H) selection**

The position of the decimal point changes depending on the Input range type and the Decimal point position selection type, because the Modbus protocol does not recognize data with decimal points during communication.

[Type of decimal points position]

Temperature input: No decimal place, One decimal place, Two decimal places

Voltage/Current input: No decimal place, One decimal place, Two decimal places,
Three decimal places, Four decimal places

Measured value (PV)	Input error determination point (high)
Set value (SV) monitor	Input error determination point (low)
Remote setting input value (RS) monitor	Transmission output scale high
Event 1 set value (EV1)	Transmission output scale low
Event 2 set value (EV2)	Event 1 differential gap
Event 3 set value (EV3)	Event 2 differential gap
Event 4 set value (EV4)	Event 3 differential gap
LBA deadband	Event 4 differential gap
Set value (SV)	Start determination point
Proportional band [heat-side]	ON/OFF action differential gap (upper)
Proportional band [cool-side]	ON/OFF action differential gap (lower)
Overlap/Deadband	AT bias
Setting change rate limiter (up)	Proportional band limiter (high) [heat-side]
Setting change rate limiter (down)	Proportional band limiter (low) [heat-side]
PV bias	Proportional band limiter (high) [cool-side]
RS bias	Proportional band limiter (low) [cool-side]
Manual manipulated output value	Setting limiter high
Input scale high	Setting limiter low
Input scale low	

Example: When Set value (SV) is $-20.0\text{ }^{\circ}\text{C}$, -20.0 is processed as -200 ,
 $-200 = 0000\text{H} - 00\text{C8H} = \text{FF38H}$

Set value (SV)	High	FFH
	Low	38H

● **Data with no decimal place**

- Model codes
- Burnout state monitor
- Burnout state monitor of feedback resistance input
- Event 1 state monitor
- Event 2 state monitor
- Event 3 state monitor
- Event 4 state monitor
- Heater break alarm 1 (HBA1) state monitor
- Heater break alarm 2 (HBA2) state monitor
- Error code
- Digital input (DI) state monitor
- Output state monitor
- Operation mode state monitor
- Memory area soak time monitor
- Integrated operating time monitor
- Backup memory state monitor
- ROM version monitor
- PID/AT transfer
- Auto/Manual transfer
- Remote/Local transfer
- RUN/STOP transfer
- Memory area transfer
- Interlock release
- Control loop break alarm (LBA) time
- Control response parameter
- Area soak time
- Link area number
- Set lock level
- STOP display
- Bar graph display
- Bar graph display resolution
- Direct key 1 (Direct key selection^a)
- Direct key 2^b
- Direct key 3^b
- Direct key type
- Input type
- Display unit
- Decimal point position
- TC input burnout direction
- Square root extraction
- Power supply frequency
- Sampling cycle
- Remote setting input type
- Digital input (DI) assignment
- Output assignment
- Energized/De-energized
- Alarm (ALM) lamp lighting condition 1
- Alarm (ALM) lamp lighting condition 2
- Output status at STOP mode
- Transmission output type
- ^a FB100
- ^b FB400/900
- Event 1 type
- Event 1 hold action
- Event 1 interlock
- Force ON of Event 1 action
- Event 2 type
- Event 2 hold action
- Event 2 interlock
- Force ON of Event 2 action
- Event 3 type
- Event 3 hold action
- Event 3 interlock
- Force ON of Event 3 action
- Event 4 type
- Event 4 hold action
- Event 4 interlock
- Force ON of Event 4 action
- CT1 ratio
- CT1 assignment
- Heater break alarm 1 (HBA1) type
- Number of heater break alarm 1 (HBA1) delay times
- CT2 ratio
- CT2 assignment
- Heater break alarm 2 (HBA2) type
- Number of heater break alarm 2 (HBA2) delay times
- Hot/Cold start
- External input type
- Master channel selection
- SV tracking
- MV transfer function
- Control action
- Integral/derivative time decimal point position
- Derivative action
- Action (high) at input error
- Action (low) at input error
- Power feed forward selection^b
- AT cycles
- Action at feedback resistance (FBR) input error
- Feedback adjustment preparation
- Control motor time
- Valve action at STOP
- Action at saturated output
- Startup tuning (ST)
- ST start condition
- Automatic temperature rise group
- Automatic temperature rise learning
- RUN/STOP group
- Setting change rate limiter unit time
- Soak time unit
- PV transfer function
- PV flashing display at input error

Example: When Integrated operating time monitor is 72 hour,

$$72 = 0048H$$

Integrated operating time monitor	High	00H
	Low	48H

6.7.2 Caution for handling communication data

- In this communication, the variables that memory area includes handles different address with for control area and for setting area.
- If data (holding register) exceeding the accessible address range is accessed, an error response message is returned.
- Read data of unused item is a default value.
- Any attempt to write to an unused item is not processed as an error. Data cannot be written into an unused item.
- If data range or address error occurs during data writing (Write Action), it is not processed as an error. Normal data is written in data register but data with error is not written; therefore, it is recommended to confirm data of changed items after the data setting.
- An attribute of the item for functions which are not in the controller is RO (read only). If read action to this item is performed, the read data will be "0." If write action to this item is performed, no error message is indicated and no data is written.
 -  For details, refer to **7. COMMUNICATION DATA LIST (P. 49)**.
- Commands should be sent at time intervals of 30 bits after the master receives the response message.

6.7.3 How to use memory area data

Memory area function can store up to 8 individual sets of SVs and parameters. One of the areas is used for control, and the currently selected area is Control area.

■ Read and write of memory area data

If any Memory area number to perform data read and write is specified by the Setting memory area number (0500H), data corresponding to the specified Memory area number is called up to the register addresses from 0501H to 0514H. By using these register addresses from 0501H to 0514H, it becomes possible to read and write data in any memory area.

Register address to specify memory area: 0500H (Setting Memory area number)

Register address of memory area data: 0501H to 0514H

 For the Memory area data list, refer to the **Chapter 7, ■ Memory area data (P. 84)**.

Data corresponding to a specified Memory area number is called up to the register addresses from 0501H to 0514H.

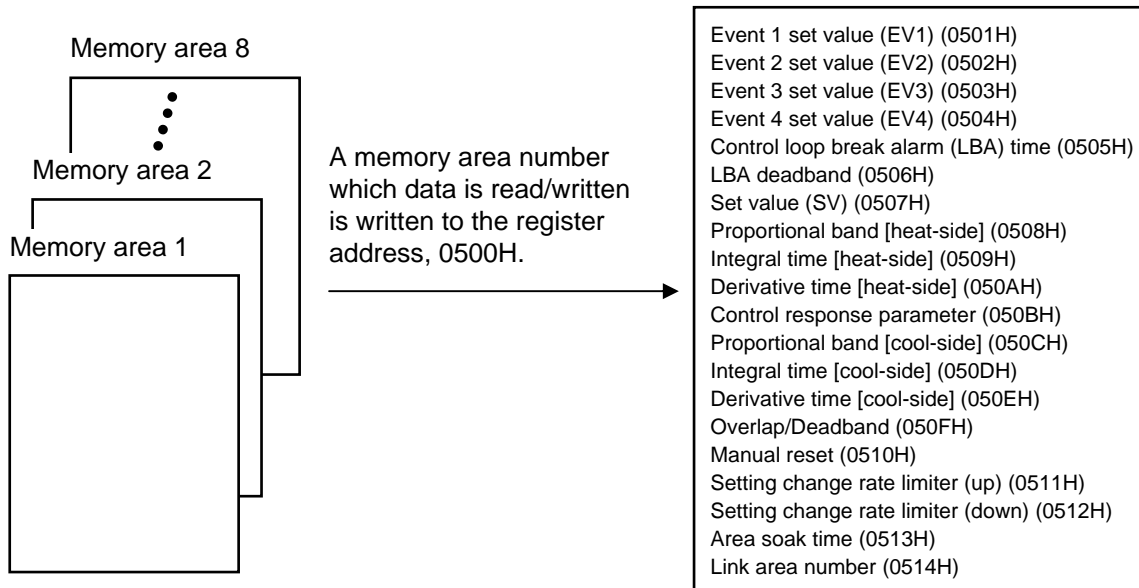

Example 1: When data on the Event 1 set value in Memory area 2 is read

1. The Memory area number, “2” is written to the Setting memory area number (0500H).
Data in Memory area 2 is called up to the register addresses from 0501H to 0514H.
2. Data on Event 1 set values (0501H) is read.

Example 2: When the Set value (SV) in Memory area 3 is changed to 200

1. The Memory area number, “3” is written to the Setting memory area number (0500H).
Data in Memory area 3 is called up to the register addresses from 0501H to 0514H.
2. “200” is written to the Set value (SV) (0507H).

■ Control area transfer

Any memory area used for control is specified by the Memory area transfer (0024H). The area (0026H to 0039H) now used for control is called Control area.



The Memory area number (Control area) can be changed at either RUN or STOP.

Data corresponding to a specified Memory area number is called up to the register addresses from 0026H to 0039H.

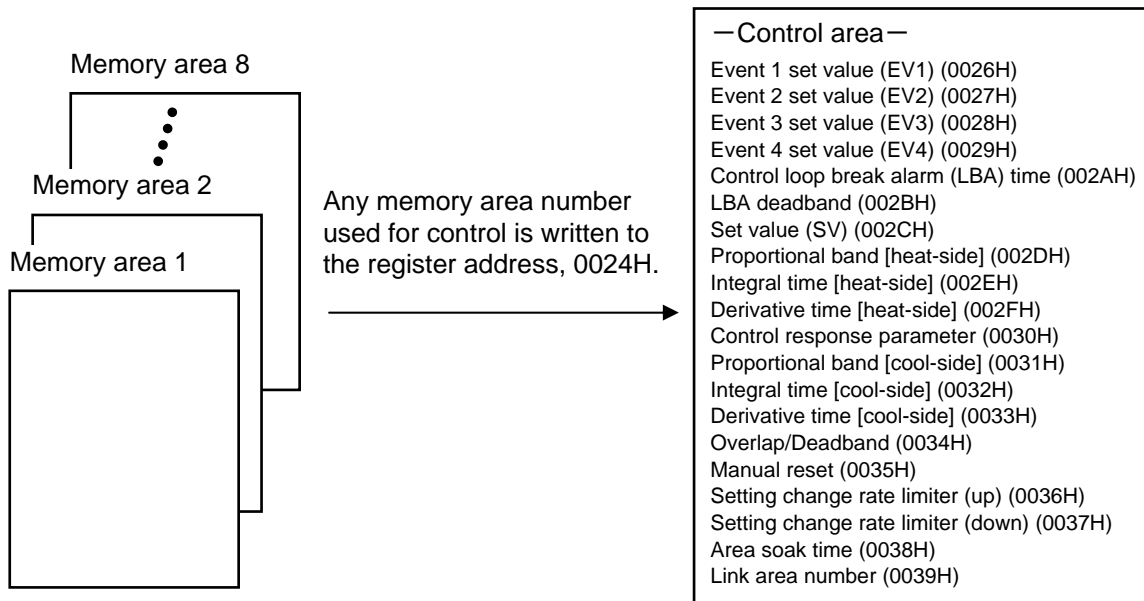

Example: When performing control by calling up data in Memory area 3

1. The Memory area number, “3” is written to the Memory area transfer (0024H).
Data in Memory area 3 is called up to the register addresses from 0026H to 0039H.
2. Control is performed by using data in the register addresses from 0026H to 0039H.



If the Memory area transfer (0024H) and the Setting memory area number (0500H) are set to the same Memory area number, the respective data can be synchronized.

- Values in the Control areas (0026H to 0039H) become the same as those in the memory areas (0501H to 0514H).
- If data in the control area is changed, data in the memory area is also changed.
- If data in the memory area is changed, data in the control area is also changed.

6.8 How to Use Data Mapping

In this communication, it is possible to continuously read/write data by freely specifying 16 sets of data.

Register address to specify mapping data: 1000H to 100FH

Register address to actually read/write data: 1500H to 150FH

Register address of data which can be mapped: Refer to **Chapter 7, ■ Communication data (P. 50)**.

 For the data mapping address list, refer to the **Chapter 7, ■ Data mapping address (P. 87)**.

Example 1: When mapping Measured value (PV), Event 1 state monitor, Event 2 state monitor and Manipulated output value (MV1) monitor [heat-side] to the register addresses from 1500H to 1503H

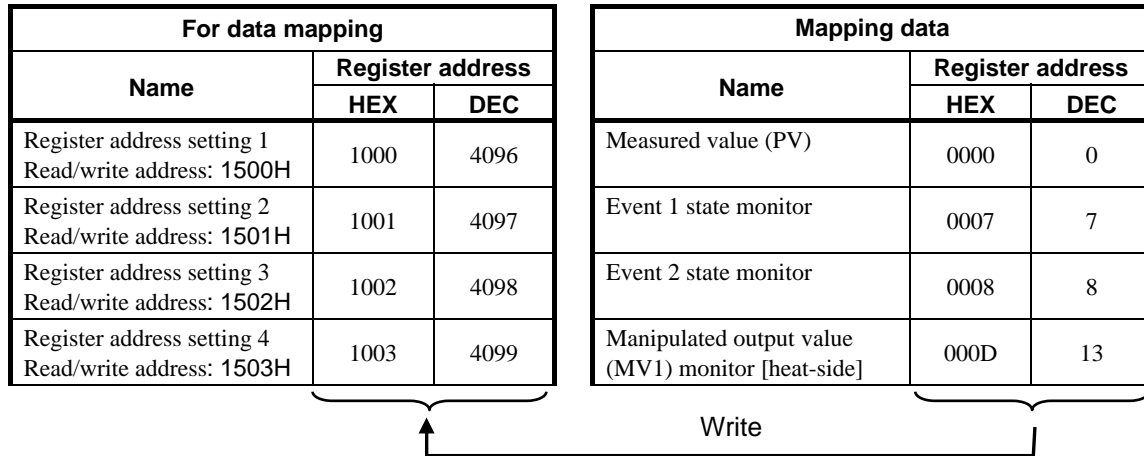

1. The register address, “0000H” of the Measured value (PV) to be mapped is written to register address setting 1 (1000H).
2. The register address, “0007H” of the Event 1 state monitor to be mapped is written to register address setting 2 (1001H).
3. The register address, “0008H” of the Event 2 state monitor to be mapped is written to register address setting 3 (1002H).
4. The register address, “000DH” of the Manipulated output value (MV1) monitor [heat-side] to be mapped is written to register address setting 4 (1003H).
5. The assignment of the register addresses from 1500H to 1503H from/to which data is actually read/written becomes as follows.

Register address		Name
HEX	DEC	
1500	5376	Measured value (PV)
1501	5377	Event 1 state monitor
1502	5378	Event 2 state monitor
1503	5379	Manipulated output value (MV1) monitor [heat-side]

High-speed communication is performed by reading or writing data in the consecutive register addresses from 1500H to 1503H.

7. COMMUNICATION DATA LIST

■ Reference to communication data list

No.	Name	RKC Identifier	Modbus register address		Attribute	Data range	Factory set value
			HEX	DEC			
1	Model codes	ID	—	—	RO	Model code (character)	—
2	Measured value (PV)	M1	0000	0	RO	Input scale low to Input scale high Varies with the setting of the Decimal point position.	—

(1) **Name:** Communication data name

(2) **RKC communication identifier:** Communication identifier of RKC communication

(3) **Modbus register address:** Register addresses of each channel
 HEX: Hexadecimal
 DEC: Decimal

(4) **Attribute:** A method of how communication data items are read or written when viewed from the host computer is described

RO: Read only data

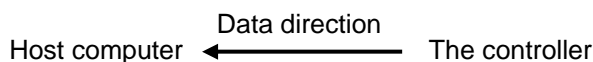

R/W: Read and Write data

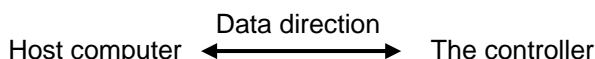

(5) **Data range:** Read or write range of communication data

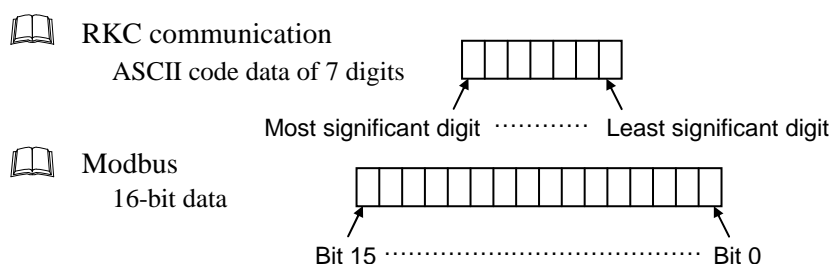

(6) **Factory set value:** Factory set value of communication data

👉 For the Memory area data, refer to the ■ **Memory area data (P. 84)**.

👉 For the data mapping address, refer to the ■ **Data mapping address (P. 87)**.

👉 For details on the data, refer to the **FB100 Instruction Manual (IMR01W16-E□)** or **FB400/FB900 Instruction Manual (IMR01W03-E□)**.

■ Communication data (RKC communication/Modbus)



For data corresponding to Nos. 78 to 223 (other than No. 206 Startup tuning and No. 212 Automatic temperature rise learning), its attribute becomes RO (Read only data) during RUN (control). When setting data corresponding to Nos. 78 to 223 (other than No. 206 and No. 212), write the data after STOP (control stop) is selected.

No.	Name	RKC Identifier	Modbus register address		Attribute	Data range	Factory set value
			HEX	DEC			
1	Model codes	ID	—	—	RO	Model code (character)	—
2	Measured value (PV)	M1	0000	0	RO	Input scale low to Input scale high Varies with the setting of the Decimal point position.	—
3	Current transformer 1 (CT1) input value monitor	M3	0001	1	RO	CTL-6-P-N: 0.0 to 30.0 A	—
4	Current transformer 2 (CT2) input value monitor	M4	0002	2	RO	CTL-12-S56-10L-N: 0.0 to 100.0 A	—
5	Set value (SV) monitor	MS	0003	3	RO	Setting limiter low to Setting limiter high Varies with the setting of the Decimal point position.	—
6	Remote setting (RS) input value monitor	S2	0004	4	RO	Setting limiter low to Setting limiter high Varies with the setting of the Decimal point position.	—
7	Burnout state monitor	B1	0005	5	RO	0: OFF 1: ON	—
8	Burnout state monitor of feedback resistance input	B2	0006	6	RO	0: OFF 1: ON	—
9	Event 1 state monitor	AA	0007	7	RO	0: OFF 1: ON	—
10	Event 2 state monitor	AB	0008	8	RO		—
11	Event 3 state monitor	AC	0009	9	RO		—
12	Event 4 state monitor	AD	000A	10	RO		—
13	Heater break alarm 1 (HBA1) state monitor	AE	000B	11	RO	0: OFF 1: ON	—
14	Heater break alarm 2 (HBA2) state monitor	AF	000C	12	RO		—
15	Manipulated output value (MV1) monitor [heat-side]	O1	000D	13	RO	PID control or Heat/Cool PID control: -5.0 to +105.0 % Position proportioning PID control with Feedback resistance (FBR) input: 0.0 to 100.0 %	—
16	Manipulated output value (MV2) monitor [cool-side]	O2	000E	14	RO	-5.0 to +105.0 %	—

Continued on the next page.

Continued from the previous page.

No.	Name	RKC Identifier	Modbus register address		Attribute	Data range	Factory set value
			HEX	DEC			
17	Error code	ER	000F	15	RO	RKC communication 1: Adjustment data error 2: Back-up error 4: A/D conversion error 32: Custom data error 128: Watchdog timer error 256: Stack overflow 2048: Program error (busy) If two or more errors occur simultaneously, the total summation of these error codes is displayed.	—
						Modbus (Bit data) Bit 0: Adjustment data error Bit 1: Back-up error Bit 2: A/D conversion error Bit 3: Unused Bit 4: Unused Bit 5: Custom data error Bit 6: Unused Bit 7: Watchdog timer error Bit 8: Stack overflow Bit 9 to Bit 10: Unused Bit 11: Program error (busy) Bit 12 to Bit 15: Unused Data 0: OFF 1: ON [Decimal number: 0 to 2471]	—
18	Digital input (DI) state monitor	L1	0010	16	RO	RKC communication Least significant digit: DI1 2nd digit: DI2 3rd digit: DI3 4th digit: DI4 5th digit: DI5 6th digit: DI6 * Most significant digit: DI7 * Data 0: Contact open 1: Contact closed * Unused on the FB100.	—

Continued on the next page.

7. COMMUNICATION DATA LIST

Continued from the previous page.

No.	Name	RKC Identifier	Modbus register address		Attribute	Data range	Factory set value
			HEX	DEC			
18	Digital input (DI) state monitor (A continuance)	L1	0010	16	RO	Modbus (Bit data) Bit 0: DI1 Bit 1: DI2 Bit 2: DI3 Bit 3: DI4 Bit 4: DI5 Bit 5: DI6 * Bit 6: DI7 * Bit 7 to Bit 15: Unused Data 0: Contact open 1: Contact closed [Decimal number: 0 to 127] * Unused on the FB100.	—
19	Output state monitor	Q1	0011	17	RO	RKC communication Least significant digit: OUT1 2nd digit: OUT2 3rd digit: DO1 4th digit: DO2 5th digit: DO3 * 6th digit: DO4 * Most significant digit: Unused Data 0: OFF 1: ON * Unused on the FB100.	—
						Modbus (Bit data) Bit 0: OUT1 Bit 1: OUT2 Bit 2: DO1 Bit 3: DO2 Bit 4: DO3 * Bit 5: DO4 * Bit 6 to Bit 15: Unused Data 0: OFF 1: ON [Decimal number: 0 to 63] * Unused on the FB100.	—

Continued on the next page.

Continued from the previous page.

No.	Name	RKC Identifier	Modbus register address		Attribute	Data range	Factory set value
			HEX	DEC			
20	Operation mode state monitor	L0	0012	18	RO	RKC communication Least significant digit: Control STOP 2nd digit: Control RUN 3rd digit: Manual mode * 4th digit: Remote mode * 5th digit to Most significant digit: Unused Data 0: OFF 1: ON * During operation in Manual mode, the Manual mode of the Operation mode state monitor is set to the "1: ON" state and the Remote mode of the same monitor is set to the "0: OFF" state even if the parameter, Remote/Local transfer is set to "1: Remote mode."	—
						Modbus (Bit data) Bit 0: Control STOP Bit 1: Control RUN Bit 2: Manual mode * Bit 3: Remote mode * Bit 4 to Bit 15: Unused Data 0: OFF 1: ON [Decimal number: 0 to 15] * During operation in Manual mode, the Manual mode of the Operation mode state monitor is set to the "1: ON" state and the Remote mode of the same monitor is set to the "0: OFF" state even if the parameter, Remote/Local transfer is set to "1: Remote mode."	—
21	Memory area soak time monitor	TR	0013	19	RO	0 minutes 00 seconds to 199 minutes 59 seconds: RKC communication: 0:00 to 199:59 (min:sec) Modbus: 0 to 11999 seconds 0 hours 00 minutes to 99 hours 59 minutes: RKC communication: 0:00 to 99:59 (hrs:min) Modbus: 0 to 5999 minutes Data range of Area soak time can be selected on the Soak time unit.	—
22	Integrated operating time monitor	UT	0014	20	RO	0 to 19999 hours	—
23	Holding peak value ambient temperature monitor	Hp	0015	21	RO	-10.0 to +100.0 °C	—

Continued on the next page.

Continued from the previous page.

No.	Name	RKC Identifier	Modbus register address		Attribute	Data range	Factory set value
			HEX	DEC			
24	Power feed forward input value monitor ♦	HM	0016	22	RO	0.0 to 160.0 % Display in the percentage of the load voltage (rated value).	—
25	Backup memory state monitor	EM	0017	23	RO	0: The content of the backup memory does not coincide with that of the RAM. 1: The content of the backup memory coincides with that of the RAM.	—
26	ROM version monitor	VR	—	—	RO	ROM version	—
27	Unused	—	0018	24	—	—	—
28	Unused	—	0019	25	—	—	—
29	Unused	—	001A	26	—	—	—
30	Unused	—	001B	27	—	—	—
31	Unused	—	001C	28	—	—	—
32	Unused	—	001D	29	—	—	—
33	Unused	—	001E	30	—	—	—
34	Unused	—	001F	31	—	—	—
35	PID/AT transfer	G1	0020	32	R/W	0: PID control 1: Autotuning (AT) * * When the Autotuning (AT) is finished, the control will automatically returns to "0: PID control."	0
36	Auto/Manual transfer	J1	0021	33	R/W	0: Auto mode 1: Manual mode	0
37	Remote/Local transfer	C1	0022	34	R/W	0: Local mode 1: Remote mode When performing Remote control by Remote setting input and also performing Cascade control and Ratio setting via Intercontroller communication, transfer to the Remote mode. [FB100] When the Remote setting (RS) input is not provided, this data becomes RO (Read only data).	0
38	RUN/STOP transfer	SR	0023	35	R/W	0: RUN mode (Control start) 1: STOP mode (Control stop)	0
39	Memory area transfer	ZA	0024	36	R/W	1 to 8 [FB100] When the Digital input (DI) assignment (No. 97) value is 6 to 12 and control area Local/External transfer is External mode, this data becomes RO (Read only data).	1

♦ Unused on the FB100.

Continued on the next page.

Continued from the previous page.

No.	Name	RKC Identifier	Modbus register address		Attribute	Data range	Factory set value
			HEX	DEC			
40	Interlock release	IL	0025	37	R/W	0: Interlock release (execution/state) 1: Interlock An event whose Event interlock is set to "1: Used" is set to the event ON state results in "1: Interlocked state." "1" is for monitoring the interlocked state. Under this condition, do not write "1."	0
41	Event 1 set value (EV1) ★	A1	0026	38	R/W	Deviation: –Input span to +Input span Varies with the setting of the Decimal point position.	50
42	Event 2 set value (EV2) ★	A2	0027	39	R/W	Process and set value: Input scale low to Input scale high Varies with the setting of the Decimal point position.	50
43	Event 3 set value (EV3) ★	A3	0028	40	R/W	Manipulated output value (MV1 or MV2): –5.0 to +105.0 %	50
44	Event 4 set value (EV4) ★	A4	0029	41	R/W	If the Event type corresponds to "0: None," set to RO (Read only data). If Event 4 corresponds to "9: Control loop break alarm (LBA)," the Event 4 set value becomes RO (Read only data).	50
45	Control loop break alarm (LBA) time ★	A5	002A	42	R/W	0 to 7200 seconds (0: Unused) If Event 4 is other than "9: Control loop break alarm (LBA)," set to RO (Read only data).	480
46	LBA deadband ★	N1	002B	43	R/W	0 to Input span Varies with the setting of the Decimal point position. If Event 4 is other than "9: Control loop break alarm (LBA)," set to RO (Read only data).	0
47	Set value (SV) ★	S1	002C	44	R/W	Setting limiter low to Setting limiter high Varies with the setting of the Decimal point position.	TC/RTD: 0 V/I: 0.0
48	Proportional band [heat-side] ★	P1	002D	45	R/W	TC/RTD inputs: 0 (0.0, 0.00) to Input span (Unit: °C [°F]) Varies with the setting of the Decimal point position. Voltage (V)/Current (I) inputs: 0.0 to 1000.0 % of input span (0, 0.0, 0.00: ON/OFF action)	TC/RTD: 30 V/I: 30.0

★ Data related to Multi-memory area function

Continued on the next page.

Continued from the previous page.

No.	Name	RKC Identifier	Modbus register address		Attribute	Data range	Factory set value
			HEX	DEC			
49	Integral time [heat-side] ★	I1	002E	46	R/W	PID control or Heat/Cool PID control: 0 to 3600 seconds or 0.0 to 1999.9 seconds (0, 0.0: PD action) [both heat-side and cool-side] Position proportioning PID control: 1 to 3600 seconds or 0.1 to 1999.9 seconds Varies with the setting of the Integral/ Derivative time decimal point position.	240
50	Derivative time [heat-side] ★	D1	002F	47	R/W	0 to 3600 seconds or 0.0 to 1999.9 seconds (0, 0.0: PI action) Varies with the setting of the Integral/ Derivative time decimal point position.	60
51	Control response parameter ★	CA	0030	48	R/W	0: Slow 1: Medium 2: Fast When the P or PD action is selected, this setting becomes invalid.	PID control, Position proportioning PID control: 0 Heat/Cool PID control: 2
52	Proportional band [cool-side] ★	P2	0031	49	R/W	TC/RTD inputs: 1 (0.1, 0.01) to Input span (Unit: °C [°F]) Varies with the setting of the Decimal point position. Voltage (V)/Current (I) inputs: 0.1 to 1000.0 % of input span If control is other than Heat/Cool PID control, set to RO (Read only data).	TC/RTD: 30 V/I: 30.0
53	Integral time [cool-side] ★	I2	0032	50	R/W	0 to 3600 seconds or 0.0 to 1999.9 seconds (0, 0.0: PD action) [both heat-side and cool-side] Varies with the setting of the Integral/Derivative time decimal point position. If control is other than Heat/Cool PID control, set to RO (Read only data).	240
54	Derivative time [cool-side] ★	D2	0033	51	R/W	0 to 3600 seconds or 0.0 to 1999.9 seconds (0, 0.0: PI action) Varies with the setting of the Integral/Derivative time decimal point position. If control is other than Heat/Cool PID control, set to RO (Read only data).	60

★ Data related to Multi-memory area function

Continued on the next page.

Continued from the previous page.

No.	Name	RKC Identifier	Modbus register address		Attribute	Data range	Factory set value
			HEX	DEC			
55	Overlap/Deadband ★	V1	0034	52	R/W	TC/RTD inputs: –Input span to +Input span (Unit:°C [°F]) Varies with the setting of the Decimal point position. Voltage (V)/Current (I) inputs: –100.0 to +100.0 % of input span Minus (–) setting results in Overlap. However, the overlapping range is within the proportional range. If control is other than Heat/Cool PID control, set to RO (Read only data).	0
56	Manual reset ★	MR	0035	53	R/W	–100.0 to +100.0 % The offset can be manually eliminated. If the Integral function is valid, set to RO (Read only data).	0.0
57	Setting change rate limiter (up) ★	HH	0036	54	R/W	0 to Input span/unit time * (0: Unused)	0
58	Setting change rate limiter (down) ★	HL	0037	55	R/W	Varies with the setting of the Decimal point position. * Unit time: 60 seconds (factory set value)	0
59	Area soak time ★	TM	0038	56	R/W	0 minutes 00 seconds to 199 minutes 59 seconds: RKC communication: 0:00 to 199:59 (min:sec) Modbus: 0 to 11999 seconds 0 hours 00 minutes to 99 hours 59 minutes: RKC communication: 0:00 to 99:59 (hrs:min) Modbus: 0 to 5999 minutes Data range of Area soak time can be selected on the Soak time unit. [FB100] When the Digital input (DI) assignment (No. 97) value is 6 to 12, this data becomes RO (Read only data).	RKC communication: 0:00 Modbus: 0
60	Link area number ★	LP	0039	57	R/W	0 to 8 (0: No link) [FB100] When the Digital input (DI) assignment (No. 97) value is 6 to 12, this data becomes RO (Read only data).	0
61	Heater break alarm 1 (HBA1) set value	A7	003A	58	R/W	When CT is CTL-6-P-N: 0.0 to 30.0 A (0.0: Not used) When CT is CTL-12-S56-10L-N: 0.0 to 100.0 A (0.0: Not used) If there is no Current transformer 1 (CT1) or CT1 is assigned to “0: None,” set to RO (Read only data).	0.0

★ Data related to Multi-memory area function

Continued on the next page.

Continued from the previous page.

No.	Name	RKC Identifier	Modbus register address		Attribute	Data range	Factory set value
			HEX	DEC			
62	Heater break determination point 1	NE	003B	59	R/W	0.0 to 100.0 % of HBA1 set value (0.0: Heater break determination is invalid) If there is no Current transformer 1 (CT1) or CT1 is assigned to "0: None," set to RO (Read only data). If Heater break alarm 1 (HBA1) corresponds to "0: Type A," set to RO (Read only data).	30.0
63	Heater melting determination point 1	NF	003C	60	R/W	0.0 to 100.0 % of HBA1 set value (0.0: Heater melting determination is invalid) If there is no Current transformer 1 (CT1) or CT1 is assigned to "0: None," set to RO (Read only data). If Heater break alarm 1 (HBA1) corresponds to "0: Type A," set to RO (Read only data).	30.0
64	Heater break alarm 2 (HBA2) set value	A8	003D	61	R/W	When CT is CTL-6-P-N: 0.0 to 30.0 A (0.0: Not used) When CT is CTL-12-S56-10L-N: 0.0 to 100.0 A (0.0: Not used) If there is no Current transformer 2 (CT2) or CT2 is assigned to "0: None," set to RO (Read only data).	0.0
65	Heater break determination point 2	NH	003E	62	R/W	0.0 to 100.0 % of HBA2 set value (0.0: Heater break determination is invalid) If there is no Current transformer 2 (CT2) or CT2 is assigned to "0: None," set to RO (Read only data). If Heater break alarm 2 (HBA2) corresponds to "0: Type A," set to RO (Read only data).	30.0
66	Heater melting determination point 2	NI	003F	63	R/W	0.0 to 100.0 % of HBA2 set value (0.0: Heater melting determination is invalid) If there is no Current transformer 2 (CT2) or CT2 is assigned to "0: None," set to RO (Read only data). If Heater break alarm 2 (HBA2) corresponds to "0: Type A," set to RO (Read only data).	30.0
67	PV bias	PB	0040	64	R/W	-Input span to +Input span Varies with the setting of the Decimal point position.	0
68	PV digital filter	F1	0041	65	R/W	0.0 to 100.0 seconds (0.0: Unused)	0.0
69	PV ratio	PR	0042	66	R/W	0.500 to 1.500	1.000

Continued on the next page.

Continued from the previous page.

No.	Name	RKC Identifier	Modbus register address		Attribute	Data range	Factory set value
			HEX	DEC			
70	PV low input cut-off	DP	0043	67	R/W	0.00 to 25.00 % of input span If the Input square root extraction corresponds to "0: Unused," set to RO (Read only data).	0.00
71	RS bias Cascade control: Cascade bias Ratio setting: Ratio setting bias	RB	0044	68	R/W	–Input span to +Input span Varies with the setting of the Decimal point position. [FB100] When the Remote setting (RS) input is not provided, this data becomes RO (Read only data).	0
72	RS digital filter Cascade control: Cascade digital filter Ratio setting: Ratio setting digital filter	F2	0045	69	R/W	0.0 to 100.0 seconds (0.0: Unused) [FB100] When the Remote setting (RS) input is not provided, this data becomes RO (Read only data).	0.0
73	RS ratio Cascade control: Cascade ratio Ratio setting: Ratio setting ratio	RR	0046	70	R/W	0.001 to 9.999 [FB100] When the Remote setting (RS) input is not provided, this data becomes RO (Read only data).	1.000
74	Proportional cycle time [heat-side]	T0	0047	71	R/W	0.1 to 100.0 seconds This item becomes RO (Read only data) for the Voltage/Current output specification.	Relay contact output: 20.0 Voltage pulse output, Triac output and Open collector output: 2.0
75	Proportional cycle time [cool-side]	T1	0048	72	R/W	0.1 to 100.0 seconds If control is other than Heat/Cool PID control, set to RO (Read only data). This item becomes RO (Read only data) for the Voltage/Current output specification.	Relay contact output: 20.0 Voltage pulse output, Triac output and Open collector output: 2.0
76	Manual manipulated output value	ON	0049	73	R/W	PID control: Output limiter low (MV1) to Output limiter high (MV1) Heat/Cool PID control: –Output limiter high (MV2) to +Output limiter high (MV1) For overlap: –105.0 to +105.0 % * * Actual output value is limited by the output limiter function. When the control motor with Feedback resistance (FBR) is used: Output limiter low (MV1) to Output limiter high (MV1)	0.0

Continued on the next page.

Continued from the previous page.

No.	Name	RKC Identifier	Modbus register address		Attribute	Data range	Factory set value
			HEX	DEC			
77	Set lock level	LK	004A	74	R/W	RKC communication Least significant digit: Lock only setting items other than SV and Event set value (EV1 to EV4). 2nd digit: Lock only Event set value (EV1 to EV4) 3rd digit: Lock only Set value (SV) 4th digit to Most significant digit: Unused Data 0: Unlock 1: Lock	0
						Modbus (Bit data) Bit 0: Lock only setting items other than SV and Event set value (EV1 to EV4). Bit 1: Lock only Event set value (EV1 to EV4) Bit 2: Lock only Set value (SV) Bit 3 to Bit 15: Unused Data 0: Unlock 1: Lock [Decimal number: 0 to 7]	0
78	STOP display	DX	004B	75	R/W	0: SToP is displayed on the PV display. 1: SToP is displayed on the SV display.	1
79	Bar graph display	DA	004C	76	R/W	0: No display 1: Manipulated output value (MV) 2: Measured value (PV) 3: Set value (SV) monitor 4: Deviation value 5: CT1 input value 6: CT2 input value	1
80	Bar graph display resolution	DE	004D	77	R/W	1 to 100 digit/dot Becomes valid when the Bar graph display is "4: Deviation value," "5: CT1 input value" or "6: CT2 input value."	100
81	Direct key 1 [FB100] Direct key selection	DK	004E	78	R/W	[FB100] 0: Unused 1: Used [FB400/900] 0: Unused 1: A/M transfer key (Type 1, Type 2)	1
82	Direct key 2 ♦	DL	004F	79	R/W	0: Unused 1: MONI key (For type 1) or R/L transfer key (For type 2)	1

♦ Unused on the FB100.

Continued on the next page.

Continued from the previous page.

No.	Name	RKC Identifier	Modbus register address		Attribute	Data range	Factory set value
			HEX	DEC			
83	Direct key 3 ♦	DM	0050	80	R/W	0: Unused 1: AREA key (For type 1) or RUN/STOP transfer key (For type 2)	1
84	Direct key type	DN	0051	81	R/W	[FB100] 1: Auto/Manual transfer 2: Monitor 3: Memory area transfer 4: Remote/Local transfer 5: RUN/STOP transfer [FB400/900] 1: Type 1 2: Type 2	1
85	Input type	XI	0052	82	R/W	0: TC input K 1: TC input J 2: TC input R 3: TC input S 4: TC input B 5: TC input E 6: TC input N 7: TC input T 8: TC input W5Re/W26Re 9: TC input PLII 10: TC input U 11: TC input L 12: RTD input Pt100 13: RTD input JPt100 14: Current input 0 to 20 mA DC 15: Current input 4 to 20 mA DC 16: Voltage (high) input 0 to 10 V DC 17: Voltage (high) input 0 to 5 V DC 18: Voltage (high) input 1 to 5 V DC 19: Voltage (low) input 0 to 1 V DC 20: Voltage (low) input 0 to 100 mV DC 21: Voltage (low) input 0 to 10 mV DC 24: Voltage (high) input ±1 V DC 25: Voltage (low) input ±100 mV DC 26: Voltage (low) input ±10 mV DC If changed to Voltage (high) input from TC/RTD/Current/Voltage (low) input, select the hardware by the input selector switch (for measurement input) at the side of the instrument. For the selecting procedure, refer to the FB100 Instruction Manual (IMR01W16-E□) or FB400/FB900 Instruction Manual (IMR01W03-E□) .	Based on model code. When not specifying: 0

♦ Unused on the FB100.

Continued on the next page.

Continued from the previous page.

No.	Name	RKC Identifier	Modbus register address		Attribute	Data range	Factory set value
			HEX	DEC			
86	Display unit	PU	0053	83	R/W	0: °C 1: °F The engineering unit for Voltage/Current input is expressed as %.	Based on model code. When not specifying: 0
87	Decimal point position	XU	0054	84	R/W	0: No decimal place 1: One decimal place 2: Two decimal places 3: Three decimal places 4: Four decimal places TC input: K, J, E: Only 0 or 1 can be set. T, U, L: Only 1 can be set. Other than the above: Only 0 can be set. RTD input: From 0 to 2 can be set. V/I inputs: From 0 to 4 can be set.	Based on model code. When not specifying: TC/RTD: 0 V/I: 1
88	Input scale high	XV	0055	85	R/W	TC/RTD inputs: Input scale low to Maximum value of the selected input range Voltage (V)/Current (I) inputs: -19999 to +19999 Varies with the setting of the Decimal point position.	TC/RTD: Maximum value of the selected input range V/I: 100.0
89	Input scale low	XW	0056	86	R/W	TC/RTD inputs: Minimum value of the selected input range to Input scale high Voltage (V)/Current (I) inputs: -19999 to +19999 Varies with the setting of the Decimal point position.	TC/RTD: Minimum value of the selected input range V/I: 0.0
90	Input error determination point (high)	AV	0057	87	R/W	Input scale low - (5 % of input span) to Input scale high + (5 % of input span)	TC/RTD: Input scale high + (5 % of input span) V/I: 105.0
91	Input error determination point (low)	AW	0058	88	R/W	Varies with the setting of the Decimal point position.	TC/RTD: Input scale low - (5 % of input span) V/I: -5.0
92	Burnout direction	BS	0059	89	R/W	0: Upscale 1: Downscale Valid only when the TC input and Voltage (low) input are selected.	0
93	Square root extraction	XH	005A	90	R/W	0: Unused 1: Used	0

Continued on the next page.

Continued from the previous page.

No.	Name	RKC Identifier	Modbus register address		Attribute	Data range	Factory set value
			HEX	DEC			
94	Power supply frequency	JT	005B	91	R/W	0: 50 Hz 1: 60 Hz If power frequency measurement was made possible with CT input and/or Power feed forward (PFF) input applied, set to RO (Read only data).	0
95	Sampling cycle	TZ	005C	92	R/W	0: 50 ms 1: 100 ms 2: 250 ms	1
96	Remote setting input type	XR	005D	93	R/W	14: 0 to 20 mA DC 15: 4 to 20 mA DC 16: 0 to 10 V DC 17: 0 to 5 V DC 18: 1 to 5 V DC 19: 0 to 1 V DC 20: 0 to 100 mV DC 21: 0 to 10 mV DC If changed to Voltage (high) input from Current/Voltage (low) input, select the hardware by the input selector switch [for Remote setting (SR) input] at the side of the instrument. For the selecting procedure, refer to the FB100 Instruction Manual (IMR01W16-E□) or FB400/FB900 Instruction Manual (IMR01W03-E□) .	Based on model code. When not specifying: 15
97	Digital input (DI) assignment	H2	005E	94	R/W	[FB100] 1 to 26 [FB400/900] 1 to 8 Refer to Table 1 Digital input (DI) assignment (P. 82) .	Based on model code. When not specifying: 1
98	Output assignment	E0	005F	95	R/W	[FB100] 1 to 15 [FB400/900] 1 to 7 Refer to Table 2 Output assignment (P. 83) .	Based on model code. When not specifying: FB100: 1 FB400/900: 2
99	Timer 1	TH	0060	96	R/W	0.0 to 600.0 seconds	0.0
100	Timer 2	TI	0061	97	R/W	Customization tool is necessary when the timer function is availed.	0.0
101	Timer 3	TJ	0062	98	R/W		0.0
102	Timer 4	TK	0063	99	R/W		0.0

Continued on the next page.

Continued from the previous page.

No.	Name	RKC Identifier	Modbus register address		Attribute	Data range	Factory set value
			HEX	DEC			
103	Energized/De-energized	NA	0064	100	R/W	RKC communication Least significant digit: DO1 2nd digit: DO2 3rd digit: DO3 * 4th digit: DO4 * 5th digit to Most significant digit: Unused Data 0: Energized 1: De-energized * Unused on the FB100.	0
						Modbus (Bit data) Bit 0: DO1 Bit 1: DO2 Bit 2: DO3 * Bit 3: DO4 * Bit 4 to Bit 15: Unused Data 0: Energized 1: De-energized [Decimal number: 0 to 15] * Unused on the FB100.	0
104	Alarm (ALM) lamp lighting condition 1 ^a	LY	0065	101	R/W	RKC communication Least significant digit: Event 1 2nd digit: Event 2 3rd digit: Event 3 4th digit: Event 4 5th digit to Most significant digit: Unused Data 0: ALM lamp is not lit 1: ALM lamp is lit	1111
						Modbus (Bit data) Bit 0: Event 1 Bit 1: Event 2 Bit 2: Event 3 Bit 3: Event 4 Bit 4 to Bit 15: Unused Data 0: ALM lamp is not lit 1: ALM lamp is lit [Decimal number: 0 to 15]	1111 (Bit image)

^a When two or more items are set to “1: ALM lamp is lit,” if an error occurs in any one of these item, the alarm lamp on the front of the controller lights.

Continued on the next page.

Continued from the previous page.

No.	Name	RKC Identifier	Modbus register address		Attribute	Data range	Factory set value
			HEX	DEC			
105	Alarm (ALM) lamp lighting condition 2 *	LZ	0066	102	R/W	RKC communication Least significant digit: HBA1 2nd digit: HBA2 3rd digit to Most significant digit: Unused Data 0: ALM lamp is not lit 1: ALM lamp is lit	11
						Modbus (Bit data) Bit 0: HBA1 Bit 1: HBA2 Bit 2 to Bit 15: Unused Data 0: ALM lamp is not lit 1: ALM lamp is lit [Decimal number: 0 to 3]	11 (Bit image)
106	Output status at STOP mode	SS	0067	103	R/W	RKC communication Least significant digit: Event function 2nd digit: Transmission output 3rd digit to Most significant digit: Unused Data 0: OFF 1: Action continued	0
						Modbus (Bit data) Bit 0: Event function Bit 1: Transmission output Bit 2 to Bit 15: Unused Data 0: OFF 1: Action continued [Decimal number: 0 to 3]	0
107	Unused	—	0068	104	—	—	—
108	Unused	—	0069	105	—	—	—
109	Unused	—	006A	106	—	—	—
110	Unused	—	006B	107	—	—	—
111	Unused	—	006C	108	—	—	—
112	Unused	—	006D	109	—	—	—
113	Transmission output type	LA	006E	110	R/W	0: None 1: Measured value (PV) 2: Set value (SV) monitor 3: Deviation value 4: Manipulated output value (MV1) [heat-side] 5: Manipulated output value (MV2) [cool-side] 6: Set value (SV) 7: Remote setting (RS) input value	1

* When two or more items are set to "1: ALM lamp is lit," if an error occurs in any one of these item, the alarm lamp on the front of the controller lights.

Continued on the next page.

Continued from the previous page.

No.	Name	RKC Identifier	Modbus register address		Attribute	Data range	Factory set value
			HEX	DEC			
114	Transmission output scale high	HV	006F	111	R/W	When the PV, SV, SV monitor and RS: Input scale low to Input scale high Varies with the setting of the Decimal point position. When the MV1 and MV2: -5.0 to +105.0 %	PV/SV/RS: Input scale high MV1/MV2: 100.0 Deviation: +Input span
115	Transmission output scale low	HW	0070	112	R/W	When the deviation value: -Input span to +Input span	PV/SV/RS: Input scale low MV1/MV2: 0.0 Deviation: -Input span
116	Event 1 type	XA	0071	113	R/W	0: None 1: Deviation high ¹ 2: Deviation low ¹ 3: Deviation high/low ¹ 4: Band ¹ 5: Process high ¹ 6: Process low ¹ 7: SV high 8: SV low 9: Unused 10: MV1 high [heat-side] ^{1, 2} 11: MV1 low [heat-side] ^{1, 2} 12: MV2 high [cool-side] ¹ 13: MV2 low [cool-side] ¹ ¹ Event hold action is available. ² If there is Feedback resistance (FBR) input in Position proportioning PID control, set to the Feedback resistance (FBR) input value.	Based on model code. When not specifying: 0
117	Event 1 hold action	WA	0072	114	R/W	0: OFF 1: Hold action ON (when power turned on; when transferred from STOP to RUN) 2: Re-hold action ON (when power turned on; when transferred from STOP to RUN; SV changed)	Based on model code. When not specifying: 0
118	Event 1 interlock	LF	0073	115	R/W	0: Unused 1: Used	0
119	Event 1 differential gap	HA	0074	116	R/W	① Deviation, process or set value: 0 to Input span (Unit: °C [°F]) Varies with the setting of the Decimal point position. ② MV: 0.0 to 110.0 %	①: TC/RTD: 2 V/I: 0.2 ②: 0.2

Continued on the next page.

Continued from the previous page.

No.	Name	RKC Identifier	Modbus register address		Attribute	Data range	Factory set value
			HEX	DEC			
120	Event 1 delay timer	TD	0075	117	R/W	0.0 to 600.0 seconds	0.0
121	Force ON of Event 1 action	OA	0076	118	R/W	RKC communication Least significant digit: Event output turned on at input error occurrence 2nd digit: Event output turned on in Manual mode 3rd digit: Event output turned on during the Autotuning (AT) function is being executed 4th digit: Event output turned on during the Setting change rate limiter is being operated 5th digit to Most significant digit: Unused Data 0: Invalid 1: Valid	0
						Modbus (Bit data) Bit 0: Event output turned on at input error occurrence Bit 1: Event output turned on in Manual mode Bit 2: Event output turned on during the Autotuning (AT) function is being executed Bit 3: Event output turned on during the Setting change rate limiter is being operated Bit 4 to Bit 15: Unused Data 0: Invalid 1: Valid [Decimal number: 0 to 15]	0

Continued on the next page.

Continued from the previous page.

No.	Name	RKC Identifier	Modbus register address		Attribute	Data range	Factory set value
			HEX	DEC			
122	Event 2 type	XB	0077	119	R/W	0: None 1: Deviation high ¹ 2: Deviation low ¹ 3: Deviation high/low ¹ 4: Band ¹ 5: Process high ¹ 6: Process low ¹ 7: SV high 8: SV low 9: Unused 10: MV1 high [heat-side] ^{1, 2} 11: MV1 low [heat-side] ^{1, 2} 12: MV2 high [cool-side] ¹ 13: MV2 low [cool-side] ¹ ¹ Event hold action is available. ² If there is Feedback resistance (FBR) input in Position proportioning PID control, set to the Feedback resistance (FBR) input value.	Based on model code. When not specifying: 0
123	Event 2 hold action	WB	0078	120	R/W	0: OFF 1: Hold action ON (when power turned on; when transferred from STOP to RUN) 2: Re-hold action ON (when power turned on; when transferred from STOP to RUN; SV changed)	Based on model code. When not specifying: 0
124	Event 2 interlock	LG	0079	121	R/W	0: Unused 1: Used	0
125	Event 2 differential gap	HB	007A	122	R/W	① Deviation, process or set value: 0 to Input span (Unit: °C [°F]) Varies with the setting of the Decimal point position. ② MV: 0.0 to 110.0 %	①: TC/RTD: 2 V/I: 0.2 ②: 0.2
126	Event 2 delay timer	TG	007B	123	R/W	0.0 to 600.0 seconds	0.0

Continued on the next page.

Continued from the previous page.

No.	Name	RKC Identifier	Modbus register address		Attribute	Data range	Factory set value
			HEX	DEC			
127	Force ON of Event 2 action	OB	007C	124	R/W	RKC communication Least significant digit: Event output turned on at input error occurrence 2nd digit: Event output turned on in Manual mode 3rd digit: Event output turned on during the Autotuning (AT) function is being executed 4th digit: Event output turned on during the Setting change rate limiter is being operated 5th digit to Most significant digit: Unused Data 0: Invalid 1: Valid	0
						Modbus (Bit data) Bit 0: Event output turned on at input error occurrence Bit 1: Event output turned on in Manual mode Bit 2: Event output turned on during the Autotuning (AT) function is being executed Bit 3: Event output turned on during the Setting change rate limiter is being operated Bit 4 to Bit 15: Unused Data 0: Invalid 1: Valid [Decimal number: 0 to 15]	0

Continued on the next page.

7. COMMUNICATION DATA LIST

Continued from the previous page.

No.	Name	RKC Identifier	Modbus register address		Attribute	Data range	Factory set value
			HEX	DEC			
128	Event 3 type	XC	007D	125	R/W	0: None 1: Deviation high ¹ 2: Deviation low ¹ 3: Deviation high/low ¹ 4: Band ¹ 5: Process high ¹ 6: Process low ¹ 7: SV high 8: SV low 9: Unused 10: MV1 high [heat-side] ^{1, 2} 11: MV1 low [heat-side] ^{1, 2} 12: MV2 high [cool-side] ¹ 13: MV2 low [cool-side] ¹ ¹ Event hold action is available. ² If there is Feedback resistance (FBR) input in Position proportioning PID control, set to the Feedback resistance (FBR) input value.	Based on model code. When not specifying: 0
129	Event 3 hold action	WC	007E	126	R/W	0: OFF 1: Hold action ON (when power turned on; when transferred from STOP to RUN) 2: Re-hold action ON (when power turned on; when transferred from STOP to RUN; SV changed)	Based on model code. When not specifying: 0
130	Event 3 interlock	LH	007F	127	R/W	0: Unused 1: Used	0
131	Event 3 differential gap	HC	0080	128	R/W	① Deviation, process or set value: 0 to Input span (Unit: °C [°F]) Varies with the setting of the Decimal point position. ② MV: 0.0 to 110.0 %	①: TC/RTD: 2 V/I: 0.2 ②: 0.2
132	Event 3 delay timer	TE	0081	129	R/W	0.0 to 600.0 seconds	0.0

Continued on the next page.

Continued from the previous page.

No.	Name	RKC Identifier	Modbus register address		Attribute	Data range	Factory set value
			HEX	DEC			
133	Force ON of Event 3 action	OC	0082	130	R/W	RKC communication Least significant digit: Event output turned on at input error occurrence 2nd digit: Event output turned on in Manual mode 3rd digit: Event output turned on during the Autotuning (AT) function is being executed 4th digit: Event output turned on during the Setting change rate limiter is being operated 5th digit to Most significant digit: Unused Data 0: Invalid 1: Valid	0
						Modbus (Bit data) Bit 0: Event output turned on at input error occurrence Bit 1: Event output turned on in Manual mode Bit 2: Event output turned on during the Autotuning (AT) function is being executed Bit 3: Event output turned on during the Setting change rate limiter is being operated Bit 4 to Bit 15: Unused Data 0: Invalid 1: Valid [Decimal number: 0 to 15]	0

Continued on the next page.

Continued from the previous page.

No.	Name	RKC Identifier	Modbus register address		Attribute	Data range	Factory set value
			HEX	DEC			
134	Event 4 type	XD	0083	131	R/W	0: None 1: Deviation high ¹ 2: Deviation low ¹ 3: Deviation high/low ¹ 4: Band ¹ 5: Process high ¹ 6: Process low ¹ 7: SV high 8: SV low 9: Control loop break alarm (LBA) 10: MV1 high [heat-side] ^{1, 2} 11: MV1 low [heat-side] ^{1, 2} 12: MV2 high [cool-side] ¹ 13: MV2 low [cool-side] ¹ ¹ Event hold action is available. ² If there is Feedback resistance (FBR) input in Position proportioning PID control, set to the Feedback resistance (FBR) input value.	Based on model code. When not specifying: 0
135	Event 4 hold action	WD	0084	132	R/W	0: OFF 1: Hold action ON (when power turned on; when transferred from STOP to RUN) 2: Re-hold action ON (when power turned on; when transferred from STOP to RUN; SV changed)	Based on model code. When not specifying: 0
136	Event 4 interlock	LI	0085	133	R/W	0: Unused 1: Used	0
137	Event 4 differential gap	HD	0086	134	R/W	① Deviation, process or set value: 0 to Input span (Unit: °C [°F]) Varies with the setting of the Decimal point position. ② MV: 0.0 to 110.0 % Becomes invalid when the Event 4 type corresponds to "9: Control loop break alarm (LBA)."	①: TC/RTD: 2 V/I: 0.2 ②: 0.2
138	Event 4 delay timer	TF	0087	135	R/W	0.0 to 600.0 seconds	0.0

Continued on the next page.

Continued from the previous page.

No.	Name	RKC Identifier	Modbus register address		Attribute	Data range	Factory set value
			HEX	DEC			
139	Force ON of Event 4 action	OD	0088	136	R/W	RKC communication Least significant digit: Event output turned on at input error occurrence 2nd digit: Event output turned on in Manual mode 3rd digit: Event output turned on during the Autotuning (AT) function is being executed 4th digit: Event output turned on during the Setting change rate limiter is being operated 5th digit to Most significant digit: Unused Data 0: Invalid 1: Valid Becomes invalid when the Event 4 type corresponds to "9: Control loop break alarm (LBA)."	0
						Modbus (Bit data) Bit 0: Event output turned on at input error occurrence Bit 1: Event output turned on in Manual mode Bit 2: Event output turned on during the Autotuning (AT) function is being executed Bit 3: Event output turned on during the Setting change rate limiter is being operated Bit 4 to Bit 15: Unused Data 0: Invalid 1: Valid [Decimal number: 0 to 15] Becomes invalid when the Event 4 type corresponds to "9: Control loop break alarm (LBA)."	0
140	CT1 ratio	XS	0089	137	R/W	0 to 9999	CTL-6-P-N: 800 CTL-12-S56- 10L-N: 1000
141	CT1 assignment	ZF	008A	138	R/W	0: None 1: OUT1 2: OUT2 3 to 6: Do not set this one.	1

Continued on the next page.

Continued from the previous page.

No.	Name	RKC Identifier	Modbus register address		Attribute	Data range	Factory set value
			HEX	DEC			
142	Heater break alarm 1 (HBA1) type	ND	008B	139	R/W	0: Heater break alarm 1 (HBA1) type A (Time-proportional control output) 1: Heater break alarm 1 (HBA1) type B (Continuous control output) Time-proportional control output: Relay, Voltage pulse, Triac, or Open collector output Continuous control output: Voltage/Current continuous output	Based on OUT1 model code. Time-proportional control output: 0 Continuous control output: 1
143	Number of heater break alarm 1 (HBA1) delay times	DH	008C	140	R/W	0 to 255 times	5
144	CT2 ratio	XT	008D	141	R/W	0 to 9999	CTL-6-P-N: 800 CTL-12-S56-10L-N: 1000
145	CT2 assignment	ZG	008E	142	R/W	0: None 1: OUT1 2: OUT2 3 to 6: Do not set this one.	0
146	Heater break alarm 2 (HBA2) type	NG	008F	143	R/W	0: Heater break alarm 2 (HBA2) type A (Time-proportional control output) 1: Heater break alarm 2 (HBA2) type B (Continuous control output) Time-proportional control output: Relay, Voltage pulse, Triac, or Open collector output Continuous control output: Voltage/Current continuous output	0
147	Number of heater break alarm 2 (HBA2) delay times	DF	0090	144	R/W	0 to 255 times	5
148	Hot/Cold start	XN	0091	145	R/W	0: Hot start 1 1: Hot start 2 2: Cold start 3: Stop start	0
149	Start determination point	SX	0092	146	R/W	0 to Input span (The unit is the same as input value.) (0: Action depending on the Hot/Cold start selection) Varies with the setting of the Decimal point position.	3 % of input span

Continued on the next page.

Continued from the previous page.

No.	Name	RKC Identifier	Modbus register address		Attribute	Data range	Factory set value
			HEX	DEC			
150	External input type	KM	0093	147	R/W	0: Remote setting input (remote control) 1: Intercontroller communication cascade control 2: Intercontroller communication ratio setting When performing Cascade control or Ratio setting, set the master controller to 0 (Remote control). Set slave controllers to 1 (Cascade control) or 2 (Ratio setting).	0
151	Master channel selection	MC	0094	148	R/W	0 to 31 If the external input type corresponds to "1: Cascade control" or "2: Ratio setting," the setting becomes valid.	0
152	SV tracking	XL	0095	149	R/W	0: Unused 1: Used	1
153	MV transfer function [Action taken when changed to Manual mode from Auto mode]	OT	0096	150	R/W	0: MV1 or MV2 in Auto mode is used. 1: When selected by Digital input (DI): MV1 or MV2 in previous Manual mode is used. When selected by front key: MV1 or MV2 in Auto mode is used. 2: MV1 or MV2 in previous Manual mode is used.	0
154	Control action	XE	0097	151	R/W	0: Brilliant II PID control (direct action) 1: Brilliant II PID control (reverse action) 2: Brilliant II Heat/Cool PID control [water cooling] 3: Brilliant II Heat/Cool PID control [air cooling] 4: Brilliant II Heat/Cool PID control [Cooling gain linear type] 5: Position proportioning PID control (reverse action) 6: Position proportioning PID control (direct action)	Based on model code. When not specifying: 1
155	Integral/derivative time decimal point position	PK	0098	152	R/W	0: 1 second setting (No decimal place) 1: 0.1 seconds setting (One decimal place)	0
156	Derivative action	KA	0099	153	R/W	0: Measured value derivative 1: Deviation derivative	0

Continued on the next page.

Continued from the previous page.

No.	Name	RKC Identifier	Modbus register address		Attribute	Data range	Factory set value
			HEX	DEC			
157	Undershoot suppression factor	KB	009A	154	R/W	0.000 to 1.000	Water cooling: 0.100 Air cooling: 0.250 Cooling gain linear type: 1.000
158	Derivative gain	DG	009B	155	R/W	0.1 to 10.0	6.0
159	ON/OFF action differential gap (upper)	IV	009C	156	R/W	TC/RTD inputs: 0 to Input span (Unit: °C [°F]) Varies with the setting of the Decimal point position. Voltage (V)/Current (I) inputs: 0.0 to 100.0 % of input span	TC/RTD: 1 V/I: 0.1
160	ON/OFF action differential gap (lower)	IW	009D	157	R/W		TC/RTD: 1 V/I: 0.1
161	Action (high) at input error	WH	009E	158	R/W	0: Normal control 1: Manipulated output value at input error	0
162	Action (low) at input error	WL	009F	159	R/W		0
163	Manipulated output value at input error	OE	00A0	160	R/W	–105.0 to +105.0 % Actual output values become those restricted by the Output limiter. Position proportioning PID control: If there is no Feedback resistance (FBR) input or the Feedback resistance (FBR) input is disconnected, an action taken when abnormal is in accordance with the value action setting during STOP.	0.0
164	Manipulated output value (MV1) at STOP mode	OF	00A1	161	R/W	–5.0 to +105.0 % Position proportioning PID control: Only when there is Feedback resistance (FBR) input and no Feedback resistance (FBR) input is disconnected, the Manipulated output value (MV1) during STOP is output.	–5.0
165	Manipulated output value (MV2) at STOP mode	OG	00A2	162	R/W		–5.0
166	Output change rate limiter (up) [MV1]	PH	00A3	163	R/W	0.0 to 100.0 %/seconds of Manipulated output (0.0: OFF) Becomes invalid when in Position proportioning PID control.	0.0
167	Output change rate limiter (down) [MV1]	PL	00A4	164	R/W		0.0
168	Output limiter high (MV1)	OH	00A5	165	R/W	Output limiter low (MV1) to 105.0 % Position proportioning PID control: Becomes valid only when there is Feedback resistance (FBR) input and it does not break.	105.0
169	Output limiter low (MV1)	OL	00A6	166	R/W	–5.0 % to Output limiter high (MV1) Position proportioning PID control: Becomes valid only when there is Feedback resistance (FBR) input and it does not break.	–5.0

Continued on the next page.

Continued from the previous page.

No.	Name	RKC Identifier	Modbus register address		Attribute	Data range	Factory set value
			HEX	DEC			
170	Output change rate limiter (up) [MV2]	PX	00A7	167	R/W	0.0 to 100.0 %/seconds of Manipulated output (0.0: OFF) Becomes invalid when in Position proportioning PID control.	0.0
171	Output change rate limiter (down) [MV2]	PY	00A8	168	R/W		0.0
172	Output limiter high (MV2)	OX	00A9	169	R/W	Output limiter low (MV2) to 105.0 %	105.0
173	Output limiter low (MV2)	OY	00AA	170	R/W	-5.0 % to Output limiter high (MV2)	-5.0
174	Power feed forward selection ♦	PF	00AB	171	R/W	0: Unused 1: Used	1
175	Power feed forward gain ♦	PZ	00AC	172	R/W	0.01 to 5.00	1.00
176	AT bias	GB	00AD	173	R/W	-Input span to +Input span Varies with the setting of the Decimal point position.	0
177	AT cycles	G3	00AE	174	R/W	0: 1.5 cycles 2: 2.5 cycles 1: 2.0 cycles 3: 3.0 cycles	1
178	Output value with AT turned on	OP	00AF	175	R/W	Output value with AT turned off to 105.0 % Actual output values become those restricted by the Output limiter. Position proportioning PID control: Becomes valid only when there is Feedback resistance (FBR) input and it does not break (high limit of Feedback resistance input at AT).	105.0
179	Output value with AT turned off	OQ	00B0	176	R/W	-105.0 % to Output value with AT turned on Actual output values become those restricted by the Output limiter. Position proportioning PID control: Becomes valid only when there is Feedback resistance (FBR) input and it does not break (low limit of Feedback resistance input at AT).	-105.0
180	AT differential gap time	GH	00B1	177	R/W	0.0 to 50.0 seconds	10.0
181	Proportional band adjusting factor [heat-side]	KC	00B2	178	R/W	0.01 to 10.00 times	1.00
182	Integral time adjusting factor [heat-side]	KD	00B3	179	R/W	0.01 to 10.00 times	1.00
183	Derivative time adjusting factor [heat-side]	KE	00B4	180	R/W	0.01 to 10.00 times	1.00
184	Proportional band adjusting factor [cool-side]	KF	00B5	181	R/W	0.01 to 10.00 times	1.00
185	Integral time adjusting factor [cool-side]	KG	00B6	182	R/W	0.01 to 10.00 times	1.00
186	Derivative time adjusting factor [cool-side]	KH	00B7	183	R/W	0.01 to 10.00 times	1.00

♦ Unused on the FB100.

Continued on the next page.

Continued from the previous page.

No.	Name	RKC Identifier	Modbus register address		Attribute	Data range	Factory set value
			HEX	DEC			
187	Proportional band limiter (high) [heat-side]	P6	00B8	184	R/W	TC/RTD inputs: 0 (0.0, 0.00) to Input span (Unit: °C [°F]) Varies with the setting of the Decimal point position. Voltage (V)/Current (I) inputs: 0.0 to 1000.0 % of input span	TC/RTD: Input span V/I: 1000.0
188	Proportional band limiter (low) [heat-side]	P7	00B9	185	R/W		TC/RTD: 0 V/I: 0.0
189	Integral time limiter (high) [heat-side]	I6	00BA	186	R/W	0 to 3600 seconds or 0.0 to 1999.9 seconds	3600
190	Integral time limiter (low) [heat-side]	I7	00BB	187	R/W	Varies with the setting of the Integral/Derivative time decimal point position selection.	0
191	Derivative time limiter (high) [heat-side]	D6	00BC	188	R/W	0 to 3600 seconds or 0.0 to 1999.9 seconds	3600
192	Derivative time limiter (low) [heat-side]	D7	00BD	189	R/W	Varies with the setting of the Integral/Derivative time decimal point position selection.	0
193	Proportional band limiter (high) [cool-side]	P8	00BE	190	R/W	TC/RTD inputs: 1 (0.1, 0.01) to input span (Unit: °C [°F]) Varies with the setting of the Decimal point position. Voltage (V)/Current (I) inputs: 0.1 to 1000.0 % of input span	TC/RTD: Input span V/I: 1000.0
194	Proportional band limiter (low) [cool-side]	P9	00BF	191	R/W		TC/RTD: 1 V/I: 0.1
195	Integral time limiter (high) [cool-side]	I8	00C0	192	R/W	0 to 3600 seconds or 0.0 to 1999.9 seconds	3600
196	Integral time limiter (low) [cool-side]	I9	00C1	193	R/W	Varies with the setting of the Integral/Derivative time decimal point position selection.	0
197	Derivative time limiter (high) [cool-side]	D8	00C2	194	R/W	0 to 3600 seconds or 0.0 to 1999.9 seconds	3600
198	Derivative time limiter (low) [cool-side]	D9	00C3	195	R/W	Varies with the setting of the Integral/Derivative time decimal point position selection.	0
199	Open/Close output neutral zone	V2	00C4	196	R/W	0.1 to 10.0 % of output	2.0
200	Open/Close output differential gap	VH	00C5	197	R/W	0.1 to 5.0 % of output	1.0
201	Action at feedback resistance (FBR) input error	SY	00C6	198	R/W	0: Action depending on the Valve action at STOP 1: Control action continued	0
202	Feedback adjustment	FV	00C7	199	R/W	0: Adjustment end 1: During adjustment on the open-side 2: During adjustment on the close-side	—
203	Control motor time	TN	00C8	200	R/W	5 to 1000 seconds	10

Continued on the next page.

Continued from the previous page.

No.	Name	RKC Identifier	Modbus register address		Attribute	Data range	Factory set value
			HEX	DEC			
204	Integrated output limiter	OI	00C9	201	R/W	0.0 to 200.0 % of control motor time (0.0: OFF) Becomes invalid when there is Feedback resistance (FBR) input.	150.0
205	Valve action at STOP	VS	00CA	202	R/W	0: Close-side output OFF, Open-side output OFF 1: Close-side output ON, Open-side output OFF 2: Close-side output OFF, Open-side output ON Becomes valid when there is no Feedback resistance (FBR) input or the Feedback resistance (FBR) input is disconnected.	0
206	Startup tuning (ST)	ST	00CB	203	R/W	0: ST unused 1: Execute once * 2: Execute always * When the Startup tuning is finished, the setting will automatically returns to "0: ST unused." The Startup tuning (ST) function is activated according to the ST start condition selected. If control is Position proportioning PID control, set to RO (Read only data).	0
207	ST proportional band adjusting factor	KI	00CC	204	R/W	0.01 to 10.00 times	1.00
208	ST integral time adjusting factor	KJ	00CD	205	R/W	0.01 to 10.00 times	1.00
209	ST derivative time adjusting factor	KK	00CE	206	R/W	0.01 to 10.00 times	1.00
210	ST start condition	SU	00CF	207	R/W	0: Activate the Startup tuning (ST) function when the power is turned on; when transferred from STOP to RUN; or when the Set value (SV) is changed. 1: Activate the Startup tuning (ST) function when the power is turned on; or when transferred from STOP to RUN. 2: Activate the Startup tuning (ST) function when the Set value (SV) is changed.	0
211	Automatic temperature rise group	Y7	00D0	208	R/W	0 to 16 (0: Automatic temperature rise function OFF)	0

Continued on the next page.

7. COMMUNICATION DATA LIST

Continued from the previous page.

No.	Name	RKC Identifier	Modbus register address		Attribute	Data range	Factory set value
			HEX	DEC			
212	Automatic temperature rise learning	Y8	00D1	209	R/W	0: Unused 1: Learning * * When the Automatic temperature rise learning is finished, the setting will automatically returns to "0: Unused." If the Automatic temperature rise group corresponds to "0: Automatic temperature rise function OFF," set to RO (Read only data).	1
213	Automatic temperature rise dead time	RT	00D2	210	R/W	0.1 to 1999.9 seconds	10.0
214	Automatic temperature rise gradient data	R2	00D3	211	R/W	0.1 to Input span/minutes	1.0
215	RUN/STOP group	GQ	00D4	212	R/W	0 to 16 (0: Group RUN/STOP function OFF)	0
216	Setting change rate limiter unit time	HU	00D5	213	R/W	1 to 3600 seconds	60
217	Soak time unit	RU	00D6	214	R/W	0: 0 hours 00 minutes to 99 hours 59 minutes RKC communication: 0:00 to 99:59 (hrs:min) Modbus: 0 to 5999 minutes 1: 0 minutes 00 seconds to 199 minutes 59 seconds RKC communication: 0:00 to 199:59 (min:sec) Modbus: 0 to 11999 seconds Set the data range of Memory area soak time monitor and Area soak time.	1
218	Setting limiter high	SH	00D7	215	R/W	Setting limiter low to Input scale high Varies with the setting of the Decimal point position.	Input scale high
219	Setting limiter low	SL	00D8	216	R/W	Input scale low to Setting limiter high Varies with the setting of the Decimal point position.	Input scale low
220	PV transfer function	TS	00D9	217	R/W	0: Unused 1: Used	0

Continued on the next page.

Continued from the previous page.

No.	Name	RKC Identifier	Modbus register address		Attribute	Data range	Factory set value
			HEX	DEC			
221	PV flashing display at input error	DU	00DA	218	R/W	RKC communication Least significant digit: Input error 2nd digit to Most significant digit: Unused Data 0: Flashing display 1: Non-flashing display	0
						Modbus (Bit data) Bit 0: Input error Bit 1 to Bit 15: Unused Data 0: Flashing display 1: Non-flashing display [Decimal number: 0 to 1]	0
222	Overlap/Deadband reference point	UY	00DB	219	R/W	0.0 to 1.0	0.0
223	Action at saturated output	UZ	00DC	220	R/W	0: Invalid (The close-side [or open-side] output turns to OFF when the valve position is fully closed [or opened]). 1: Valid (The close-side [or open-side] output remains ON state when the valve position is fully closed [or opened]).	0
224	Unused	—	00DD	221	—	—	—
225	Unused	—	00DE	222	—	—	—
226	Unused	—	00DF	223	—	—	—
227	Control area Local/External transfer ♣	E1	00E0	224	R/W	0: Local mode 1: External mode When the Digital input (DI) assignment (No. 97) value is 6 to 12, this data becomes R/W (Read and write data). Otherwise, this data becomes RO (Read only data).	0

♣ Unused on the FB400/900.

Table 1: Digital input (DI) assignment

[FB100]

Set value	DI1	DI2	DI3	DI4	DI5
1	Unused	Unused	Unused	Unused	Unused
2	Memory area number transfer (1 to 8)			Memory area set	RUN/STOP
3	Memory area number transfer (1 to 8)			Memory area set	Unused
4	Memory area number transfer (1 to 8)			Memory area set	AUTO/MAN
5	Memory area number transfer (1 to 8)			Memory area set	Interlock release
6	Memory area number transfer (1 to 8)			RUN/STOP	Unused
7	Memory area number transfer (1 to 8)			RUN/STOP	AUTO/MAN
8	Memory area number transfer (1 to 8)			RUN/STOP	Interlock release
9	Memory area number transfer (1 to 8)			Unused	AUTO/MAN
10	Memory area number transfer (1 to 8)			Unused	Interlock release
11	Memory area number transfer (1 to 8)			AUTO/MAN	Interlock release
12	Memory area number transfer (1 to 8)				
13	RUN/STOP	REM/LOC *	AUTO/MAN		
14	RUN/STOP	REM/LOC *	Interlock release		
15	RUN/STOP	AUTO/MAN	Interlock release		
16	REM/LOC *	AUTO/MAN	Interlock release		
17	RUN/STOP	REM/LOC *			
18	RUN/STOP	AUTO/MAN			
19	RUN/STOP	Interlock release			
20	REM/LOC *	AUTO/MAN			
21	REM/LOC *	Interlock release			
22	AUTO/MAN	Interlock release			
23	RUN/STOP				
24	REM/LOC *				
25	AUTO/MAN				
26	Interlock release				

RUN/STOP: RUN/STOP transfer AUTO/MAN: Auto/Manual transfer REM/LOC: Remote/Local transfer

* When the optional function A, C or D is selected, the Remote/Local transfer is invalid.

[FB400/900]

Set value	DI1	DI2	DI3	DI4	DI5	DI6	DI7
1	Memory area number transfer (1 to 8)			Memory area set	Unused		
2					RUN/STOP	REM/LOC	AUTO/MAN
3					RUN/STOP	REM/LOC	Interlock release
4					RUN/STOP	AUTO/MAN	Interlock release
5					REM/LOC	AUTO/MAN	Interlock release
6					RUN/STOP	Unused	Interlock release
7					REM/LOC	Unused	Interlock release
8					AUTO/MAN	Unused	Interlock release

RUN/STOP: RUN/STOP transfer AUTO/MAN: Auto/Manual transfer REM/LOC: Remote/Local transfer

Table 2: Output assignment

[FB100]

Set value	Output 1 (OUT1)	Output 2 (OUT2)	Digital output 1 (DO1)	Digital output 2 (DO2)
1	Control output 1	Control output 2	Event 1 (EV1)	Event 2 (EV2)
2	Control output 1	Control output 2	Event 1 (EV1)	Event 4 (EV4)
3	Control output 1	Control output 2	Event 1 (EV1)	HBA
4	Control output 1	Control output 2	Event 1 (EV1)	FAIL (De-energized)
5	Control output 1	Control output 2	Event 4 (EV4)	HBA
6	Control output 1	Control output 2	Event 4 (EV4)	FAIL (De-energized)
7	Control output 1	Control output 2	HBA	FAIL (De-energized)
8	Control output 1	HBA	Event 1 (EV1)	Event 2 (EV2)
9	Control output 1	HBA	Event 1 (EV1)	Event 4 (EV4)
10	Control output 1	HBA	Event 1 (EV1)	FAIL (De-energized)
11	Control output 1	HBA	Event 4 (EV4)	FAIL (De-energized)
12	Control output 1	FAIL (De-energized)	Event 1 (EV1)	Event 2 (EV2)
13	Control output 1	FAIL (De-energized)	Event 1 (EV1)	Event 4 (EV4)
14	Control output 1	Event 1 (EV1)	Event 2 (EV2)	Event 3 (EV3)
15	Control output 1	Event 4 (EV4)	Event 1 (EV1)	Event 2 (EV2)

HBA: Heater break alarm (HBA) output

- For Position proportioning PID control, output 1 (OUT1) is open-side output and output 2 (OUT2) is close-side output, regardless of the above selection.
- When Current transformer (CT) input is two-point input, Heater break alarm (HBA) output is *OR* output.
- Energized or De-energized can be selected for the Digital outputs (DO1 to DO4). [Factory set value: Energized] However, with the exception of FAIL (De-energized, fixed).
- When using for Heat/Cool PID control, select one of set values 1 to 7.
- Invalid for a Non-existing output/Event function.

[FB400/900]

Set value	Output 1 (OUT1)	Output 2 (OUT2)	Digital output 1 (DO1)	Digital output 2 (DO2)	Digital output 3 (DO3)	Digital output 4 (DO4)
1	Control output 1	Control output 2	Event 1 (EV1)	Event 2 (EV2)	Event 3 (EV3)	Event 4 (EV4)
2	Control output 1	Control output 2	Event 1 (EV1)	Event 2 (EV2)	Event 3 (EV3)	HBA1 HBA2
3	Control output 1	Control output 2	Event 1 (EV1)	Event 2 (EV2)	HBA1 HBA2	FAIL (De-energized)
4	Control output 1	Control output 2	Event 1 (EV1)	HBA1 HBA2	Event 3 (EV3)	Event 4 (EV4)
5	Control output 1	HBA1 HBA2	Event 1 (EV1)	Event 2 (EV2)	Event 3 (EV3)	Event 4 (EV4)
6	Control output 1	HBA1 HBA2	Event 1 (EV1)	Event 2 (EV2)	Event 3 (EV3)	FAIL (De-energized)
7	Control output 1	FAIL (De-energized)	Event 1 (EV1)	Event 2 (EV2)	Event 3 (EV3)	Event 4 (EV4)

HBA1: Heater break alarm 1 (HBA1) output

HBA2: Heater break alarm 2 (HBA2) output

- When Current transformer (CT) input is two-point input, Heater break alarm (HBA) output is *OR* output.
- Energized or De-energized can be selected for the Digital outputs (DO1 to DO4). [Factory set value: Energized] However, with the exception of FAIL (De-energized, fixed).
- Invalid for a Non-existing output/Event function.

■ Memory area data (Modbus)

The register addresses, 0500H to 0514H are used for checking and changing each set value belonging to the memory area.

No.	Name	Modbus register address		Attribute	Data range	Factory set value
		HEX	DEC			
1	Setting memory area number	0500	1280	R/O	1 to 8 Use to select memory area number.	1
2	Event 1 set value (EV1) ¹	0501	1281	R/W	Deviation: –Input span to +Input span Varies with the setting of the Decimal point position. Process and set value: Input scale low to Input scale high Varies with the setting of the Decimal point position.	50
3	Event 2 set value (EV2) ¹	0502	1282	R/W		50
4	Event 3 set value (EV3) ¹	0503	1283	R/W		50
5	Event 4 set value (EV4) ^{1,2}	0504	1284	R/W		50
6	Control loop break alarm (LBA) time ³	0505	1285	R/W	0 to 7200 seconds (0: Unused)	480
7	LBA deadband ³	0506	1286	R/W	0 to Input span Varies with the setting of the Decimal point position.	0
8	Set value (SV)	0507	1287	R/W	Setting limiter low to Setting limiter high Varies with the setting of the Decimal point position.	TC/RTD: 0 V/I: 0.0
9	Proportional band [heat-side]	0508	1288	R/W	TC/RTD inputs: 0 (0.0, 0.00) to Input span (Unit: °C [°F]) Varies with the setting of the Decimal point position. Voltage (V)/Current (I) inputs: 0.0 to 1000.0 % of input span 0 (0.0, 0.00): ON/OFF action	TC/RTD: 30 V/I: 30.0
10	Integral time [heat-side]	0509	1289	R/W	PID control or Heat/Cool PID control: 0 to 3600 seconds or 0.0 to 1999.9 seconds (0, 0.0: PD action) [both heat-side and cool-side] Position proportioning PID control: 1 to 3600 seconds or 0.1 to 1999.9 seconds Varies with the setting of the Integral/Derivative time decimal point position selection.	240

¹ If the Event type corresponds to “0: None,” set to RO (Read only data).

² If Event 4 corresponds to “9: Control loop break alarm (LBA),” the Event 4 set value becomes RO (Read only data).

³ If Event 4 is other than “9: Control loop break alarm (LBA),” set to RO (Read only data).

Continued on the next page.

Continued from the previous page.

No.	Name	Modbus register address		Attribute	Data range	Factory set value
		HEX	DEC			
11	Derivative time [heat-side]	050A	1290	R/W	0 to 3600 seconds or 0.0 to 1999.9 seconds (0, 0.0: PI action) Varies with the setting of the Integral/Derivative time decimal point position selection.	60
12	Control response parameter	050B	1291	R/W	0: Slow 1: Medium 2: Fast When the P or PD action is selected, this setting becomes invalid.	PID control, Position proportioning PID control: 0 Heat/Cool PID control: 2
13	Proportional band [cool-side] ¹	050C	1292	R/W	TC/RTD inputs: 1 (0.1, 0.01) to Input span (Unit: °C [°F]) Varies with the setting of the Decimal point position selection. Voltage (V)/Current (I) inputs: 0.1 to 1000.0 % of input span	TC/RTD: 30 V/I: 30.0
14	Integral time [cool-side] ¹	050D	1293	R/W	0 to 3600 seconds or 0.0 to 1999.9 seconds (0, 0.0: PD action) [both heat-side and cool-side] Varies with the setting of the Integral/Derivative time decimal point position selection.	240
15	Derivative time [cool-side] ¹	050E	1294	R/W	0 to 3600 seconds or 0.0 to 1999.9 seconds (0, 0.0: PI action) Varies with the setting of the Integral/Derivative time decimal point position selection.	60
16	Overlap/Deadband ¹	050F	1295	R/W	TC/RTD inputs: –Input span to +Input span (Unit: °C [°F]) Varies with the setting of the Decimal point position. Voltage (V)/Current (I) inputs: –100.0 to +100.0 % of input span Minus (–) setting results in Overlap. However, the overlapping range is within the proportional range.	0
17	Manual reset ²	0510	1296	R/W	–100.0 to +100.0 % The offset can be manually eliminated.	0.0

¹ If control is other than Heat/Cool PID control, set to RO (Read only data).² If the Integral function is valid, set to RO (Read only data).

Continued on the next page.

7. COMMUNICATION DATA LIST

Continued from the previous page.

No.	Name	Modbus register address		Attribute	Data range	Factory set value
		HEX	DEC			
18	Setting change rate limiter (up)	0511	1297	R/W	0 to Input span/unit time * (0: Unused) Varies with the setting of the Decimal point position. * Unit time: 60 seconds (factory set value)	0
19	Setting change rate limiter (down)	0512	1298	R/W		0
20	Area soak time	0513	1299	R/W	0 to 11999 seconds or 0 to 5999 minutes Data range of Area soak time can be selected on the Soak time unit.	0
21	Link area number	0514	1300	R/W	0 to 8 (0: No link)	0
22	Unused	0515	1301	—	—	—

■ Data mapping address (Modbus)

● Register address for data mapping

No.	Name	Modbus register address		Attribute	Data range	Factory set value
		HEX	DEC			
1	Register address setting 1 Read/write address: 1500H	1000	4096	RW	Decimal: -1 to 4095 (-1: No mapping) Hexadecimal: FFFFH to 0FFFH (FFFFH: No mapping) Set the register address of data to be assigned to 1500H to 150FH.	-1
2	Register address setting 2 Read/write address: 1501H	1001	4097	RW		-1
3	Register address setting 3 Read/write address: 1502H	1002	4098	RW		-1
4	Register address setting 4 Read/write address: 1503H	1003	4099	RW		-1
5	Register address setting 5 Read/write address: 1504H	1004	4100	RW		-1
6	Register address setting 6 Read/write address: 1505H	1005	4101	RW		-1
7	Register address setting 7 Read/write address: 1506H	1006	4102	RW		-1
8	Register address setting 8 Read/write address: 1507H	1007	4103	RW		-1
9	Register address setting 9 Read/write address: 1508H	1008	4104	RW		-1
10	Register address setting 10 Read/write address: 1509H	1009	4105	RW		-1
11	Register address setting 11 Read/write address: 150AH	100A	4106	RW		-1
12	Register address setting 12 Read/write address: 150BH	100B	4107	RW		-1
13	Register address setting 13 Read/write address: 150CH	100C	4108	RW		-1
14	Register address setting 14 Read/write address: 150DH	100D	4109	RW		-1
15	Register address setting 15 Read/write address: 150EH	100E	4110	RW		-1
16	Register address setting 16 Read/write address: 150FH	100F	4111	RW		-1

● Register address for data read/writes

No.	Name	Modbus register address		Attribute	Data range	Factory set value
		HEX	DEC			
1	Data specified by register address setting 1 (1000H)	1500	5376		Differs depending on data specified.	
2	Data specified by register address setting 2 (1001H)	1501	5377			
3	Data specified by register address setting 3 (1002H)	1502	5378			
4	Data specified by register address setting 4 (1003H)	1503	5379			
5	Data specified by register address setting 5 (1004H)	1504	5380			
6	Data specified by register address setting 6 (1005H)	1505	5381			
7	Data specified by register address setting 7 (1006H)	1506	5382			
8	Data specified by register address setting 8 (1007H)	1507	5383			
9	Data specified by register address setting 9 (1008H)	1508	5384			
10	Data specified by register address setting 10 (1009H)	1509	5385			
11	Data specified by register address setting 11 (100AH)	150A	5386			
12	Data specified by register address setting 12 (100BH)	150B	5387			
13	Data specified by register address setting 13 (100CH)	150C	5388			
14	Data specified by register address setting 14 (100DH)	150D	5389			
15	Data specified by register address setting 15 (100EH)	150E	5390			
16	Data specified by register address setting 16 (100FH)	150F	5391			

8. TROUBLESHOOTING



WARNING

- To prevent electric shock or instrument failure, always turn off the system power before replacing the instrument.
- To prevent electric shock or instrument failure, always turn off the power before mounting or removing the instrument.
- To prevent electric shock or instrument failure, do not turn on the power until all wiring is completed. Make sure that the wiring is correct before applying power to the instrument.
- To prevent electric shock or instrument failure, do not touch the inside of the instrument.
- All wiring must be performed by authorized personnel with electrical experience in this type of work.

CAUTION

All wiring must be completed before power is turned on to prevent electric shock, instrument failure, or incorrect action.

The power must be turned off before repairing work for input break and output failure including replacement of sensor, contactor or SSR, and all wiring must be completed before power is turned on again.

This section lists some of the main causes and solutions for communication problems.

If you can not solve a problem, please contact RKC sales office or the agent, on confirming the type name and specifications of the product.

■ RKC communication

Problem	Possible cause	Solution
No response	Wrong connection, no connection or disconnection of the communication cable	Confirm the connection method or condition and connect correctly
	Breakage, wrong wiring, or imperfect contact of the communication cable	Confirm the wiring or connector and repair or replace the wrong one
	Mismatch of the setting data of communication speed and data bit configuration with those of the host computer	Confirm the settings and set them correctly
	Wrong address setting	

Continued on the next page.

Continued from the previous page.

Problem	Possible cause	Solution
No response	Error in the data format	Re-examine the communication program
	Transmission line is not set to the receive state after data send (for RS-485)	
EOT return	The specified identifier is invalid	Confirm the identifier is correct or that with the correct function is specified. Otherwise correct it
	Error in the data format	Reexamine the communication program
NAK return	Error occurs on the line (parity bit error, framing error, etc.)	Confirm the cause of error, and solve the problem appropriately. (Confirm the transmitting data, and resend data)
	BCC error	
	The data exceeds the setting range	Confirm the setting range and transmit correct data
	The specified identifier is invalid	Confirm the identifier is correct or that with the correct function is specified. Otherwise correct it

■ Modbus

Problem	Possible cause	Solution
No response	Wrong connection, no connection or disconnection of the communication cable	Confirm the connection method or condition and connect correctly
	Breakage, wrong wiring, or imperfect contact of the communication cable	Confirm the wiring or connector and repair or replace the wrong one
	Mismatch of the setting data of communication speed and data bit configuration with those of the host computer	Confirm the settings and set them correctly
	Wrong address setting	
	A transmission error (overrun error, framing error, parity error or CRC-16 error) is found in the query message	Re-transmit after time-out occurs or verify communication program
	The time interval between adjacent data in the query message is too long, exceeding 24-bit time	
Error code 1	Function cod error (Specifying nonexistent function code)	Confirm the function code
Error code 2	When any address other than 0000H to 00DFH, 0500H to 0515H, 1000H to 100FH and 1500H to 150FH are specified	Confirm the address of holding register
Error code 3	When the specified number of data items in the query message exceeds the maximum number of data items available	Confirm the setting data
Error code 4	Self-diagnostic error	Turn off the power to the instrument. If the same error occurs when the power is turned back on, please contact RKC sales office or the agent.

9. ASCII 7-BIT CODE TABLE

 This table is only for use with RKC communication.

					b7	0	0	0	0	1	1	1	1
					b6	0	0	1	1	0	0	1	1
					b5	0	1	0	1	0	1	0	1
b5 to b7	b4	b3	b2	b1		0	1	2	3	4	5	6	7
	0	0	0	0	0	NUL	DLE	SP	0	@	P	'	p
	0	0	0	1	1	SOH	DC1	!	1	A	Q	a	q
	0	0	1	0	2	STX	DC2	”	2	B	R	b	r
	0	0	1	1	3	ETX	DC3	#	3	C	S	c	s
	0	1	0	0	4	EOT	DC4	\$	4	D	T	d	t
	0	1	0	1	5	ENQ	NAK	%	5	E	U	e	u
	0	1	1	0	6	ACK	SYM	&	6	F	V	f	v
	0	1	1	1	7	BEL	ETB	'	7	G	W	g	w
	1	0	0	0	8	BS	CAN	(8	H	X	h	x
	1	0	0	1	9	HT	EM)	9	I	Y	i	y
	1	0	1	0	A	LF	SUB	*	:	J	Z	j	z
	1	0	1	1	B	VT	ESC	+	;	K	[k	{
	1	1	0	0	C	FF	FS	,	<	L	¥	l	
	1	1	0	1	D	CR	GS	-	=	M]	m	}
	1	1	1	0	E	SO	RS	.	>	N	^	n	~
	1	1	1	1	F	SI	US	/	?	O	_	o	DEL



RKC INSTRUMENT INC.

HEADQUARTERS: 16-6, KUGAHARA 5-CHOME, OHTA-KU TOKYO 146-8515 JAPAN

PHONE: 03-3751-9799 (+81 3 3751 9799)

FAX: 03-3751-8585 (+81 3 3751 8585)

E-mail: info@rkcinst.co.jp

Website: <http://www.rkcinst.com/>