

FB100 Installation Manual

All Rights Reserved, Copyright © 2008, RKC INSTRUMENT INC.

IMR01W12-E3

Thank you for purchasing this RKC product. In order to achieve maximum performance and ensure proper operation of your new instrument, carefully read all the instructions in this manual. Please place the manual in a convenient location for easy reference.

This manual describes the handling precautions, mounting, wiring and specifications only. For the basic operations, refer to FB100 Quick Operation Manual (IMR01W13-EC). For detailed handling procedures and various function settings, please refer to the following separate manuals:

- FB100 Instruction Manual (IMR01W16-EC)
- FB100/FB400/FB900 Communication Instruction Manual (IMR01W04-EC)

These manuals can be downloaded from the official RKC website:
URL: http://www.rkcinst.com/english/manual_load.htm

Product Check

FB100 Installation Manual (IMR01W12-EC)	1
FB100 Quick Operation Manual (IMR01W13-EC)	1
FB100 Parameter List (IMR01W14-EC)	1
Seal (SAP-379 [for Unit and Direct key])	1
Mounting bracket (with screw)	2
Case rubber packing (KRB100-39)	1

Optional (Sold separately)

Terminal cover (KCA100-517)	1
Front cover (KRB100-36A)	1

Safety Precautions



WARNING

- An external protection device must be installed if failure of this instrument could result in damage to the instrument, equipment or injury to personnel.
- All wiring must be completed before power is turned on to prevent electric shock, fire or damage to instrument and equipment.
- This instrument must be used in accordance with the specifications to prevent fire or damage to instrument and equipment.
- This instrument is not intended for use in locations subject to flammable or explosive gases.
- Do not touch high-voltage connections such as power supply terminals, etc. to avoid electric shock.
- RKC is not responsible if this instrument is repaired, modified or disassembled by other than factory-approved personnel. Malfunction can occur and warranty is void under these conditions.

CAUTION

- This product is intended for use with industrial machines, test and measuring equipment. (It is not designed for use with medical equipment and nuclear energy.)
- This is a Class A instrument. In a domestic environment, this instrument may cause radio interference, in which case the user may be required to take additional measures.
- This instrument is protected from electric shock by reinforced insulation. Provide reinforced insulation between the wire for the input signal and the wires for instrument power supply, source of power and loads.
- Be sure to provide an appropriate surge control circuit respectively for the following:
 - If input/output or signal lines within the building are longer than 30 meters.
 - If input/output or signal lines leave the building, regardless the length.
- This instrument is designed for installation in an enclosed instrumentation panel. All high-voltage connections such as power supply terminals must be enclosed in the instrumentation panel to avoid electric shock by operating personnel.
- All precautions described in this manual should be taken to avoid damage to the instrument or equipment.
- All wiring must be in accordance with local codes and regulations.
- To prevent instrument damage or failure, protect the power line and the input/output lines from high currents with a protection device such as fuse, circuit breaker, etc.
- Prevent metal fragments or lead wire scraps from falling inside instrument case to avoid electric shock, fire or malfunction.
- Tighten each terminal screw to the specified torque found in the manual to avoid electric shock, fire or malfunction.
- For proper operation of this instrument, provide adequate ventilation for heat dispensation.
- Do not connect wires to unused terminals as this will interfere with proper operation of the instrument.
- Turn off the power supply before cleaning the instrument.
- Do not use a volatile solvent such as paint thinner to clean the instrument. Deformation or discoloration will occur. Use a soft, dry cloth to remove stains from the instrument.
- To avoid damage to instrument display, do not rub with an abrasive material or push front panel with a hard object.
- When high alarm with hold action/re-hold action is used for Event function, alarm does not turn on while hold action is in operation. Take measures to prevent overheating which may occur if the control device fails.

NOTICE

- This manual assumes that the reader has a fundamental knowledge of the principles of electricity, process control, computer technology and communications.
- The figures, diagrams and numeric values used in this manual are only for purpose of illustration.
- RKC is not responsible for any damage or injury that is caused as a result of using this instrument, instrument failure or indirect damage.
- RKC is not responsible for any damage and/or injury resulting from the use of instruments made by imitating this instrument.
- Periodic maintenance is required for safe and proper operation of this instrument. Some components have a limited service life, or characteristics that change over time.
- Every effort has been made to ensure accuracy of all information contained herein. RKC makes no warranty expressed or implied, with respect to the accuracy of the information. The information in this manual is subject to change without prior notice.
- No portion of this document may be reprinted, modified, copied, transmitted, digitized, stored, processed or retrieved through any mechanical, electronic, optical or other means without prior written approval from RKC.

1. MOUNTING



WARNING

To prevent electric shock or instrument failure, always turn off the power before mounting or removing the instrument.

1.1 Mounting Cautions

- (1) This instrument is intended to be used under the following environmental conditions. (IEC61010-1) [OVERVOLTAGE CATEGORY II, POLLUTION DEGREE 2]
 - (2) Use this instrument within the following environment conditions:
 - Allowable ambient temperature: -10 to +50 °C
 - Allowable ambient humidity: 5 to 95 % RH (Absolute humidity: MAX. W. C 29.3 g/m³ dry air at 101.3 kPa)
 - Installation environment conditions: Indoor use
Altitude up to 2000 m
 - (3) Avoid the following conditions when selecting the mounting location:
 - Rapid changes in ambient temperature which may cause condensation.
 - Corrosive or inflammable gases.
 - Direct vibration or shock to the mainframe.
 - Water, oil, chemicals, vapor or steam splashes.
 - Excessive dust, salt or iron particles.
 - Excessive induction noise, static electricity, magnetic fields or noise.
 - Direct air flow from an air conditioner.
 - Exposure to direct sunlight.
 - Excessive heat accumulation.
 - (4) Mount this instrument in the panel considering the following conditions:
 - Provide adequate ventilation space so that heat does not build up.
 - Do not mount this instrument directly above equipment that generates large amount of heat (heaters, transformers, semi-conductor functional devices, large-wattage resistors.)
 - If the ambient temperature rises above 50 °C, cool this instrument with a forced air fan, cooler, etc. Cooled air should not blow directly on this instrument.
 - In order to improve safety and the immunity to withstand noise, mount this instrument as far away as possible from high voltage equipment, power lines, and rotating machinery.
 - High voltage equipment: Do not mount within the same panel.
 - Power lines: Separate at least 200 mm.
 - Rotating machinery: Separate as far as possible.
 - (5) If this instrument is permanently connected to equipment, it is important to include a switch or circuit-breaker into the installation. This should be in close proximity to the equipment and within easy reach of the operator. It should be marked as the disconnecting device for the equipment.

1.2 Dimensions

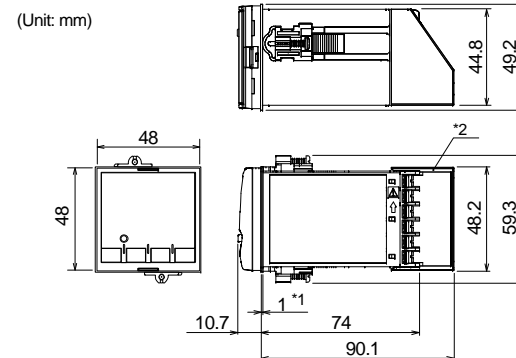

- *1 Case rubber packing
- *2 Terminal cover KCA100-517 (optional) [sold separately]

Panel cutout

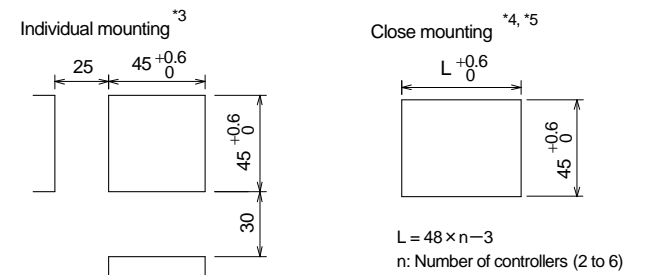

Panel thickness: 1 to 10 mm
(When mounting multiple FB100s close together, the panel strength should be checked to ensure proper support.)

*3 When cutting out each mounting hole through a panel for individual mounting, observe that there is no bur or distortion along the panel cutout surface, or there is no bend on the panel surface. If so, the water resistant characteristics may worsen.

*4 Remove the case rubber packing. Because of closely mounting the FB100s, protection will be compromised and not meet IP66 (NEMA 4X) by close mounting.

*5 When controllers are closely mounted, ambient temperature must not exceed 50 °C.

1.3 Procedures of Mounting and Removing

Mounting procedures

1. Prepare the panel cutout as specified in 1.2 Dimensions.
2. Insert the instrument through the panel cutout.
3. Insert the mounting bracket into the mounting groove of the instrument. (Fig. 1)
4. Push the mounting bracket forward until the bracket is firmly secured to the panel. (Fig. 2)
5. Only turn one full revolution after the screw touches the panel. (Fig. 3)
6. The other mounting bracket should be installed the same way described in 3. to 5.

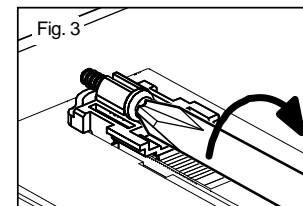
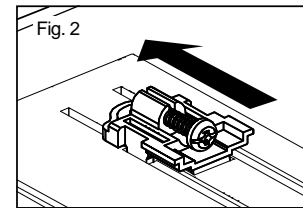
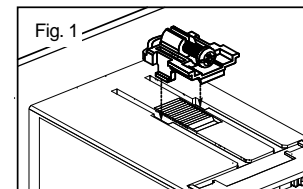

The front of the instrument conforms to IP66 (NEMA 4X) when mounted on the panel. For effective waterproof/dustproof, the gasket must be securely placed between instrument and panel without any gap. If gasket is damaged, please contact RKC sales office or the agent.

Removing procedures

1. Turn the power OFF.
2. Remove the wiring.
3. Loosen the screw of the mounting bracket. (Fig. 4)
4. Lift the latch of the mounting bracket (1), then pull the mounting bracket (2) to remove it from the case. (Fig. 4)
5. The other mounting bracket should be removed in the same way as described in 3. and 4.
6. Pull out the instrument from the mounting cutout while holding the front panel frame of this instrument. (Fig. 5)

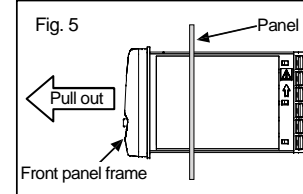
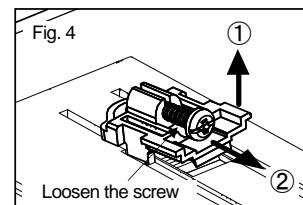

Use long-nose pliers to remove mounting brackets from the instrument that is installed in a narrow place or installed tightly in a vertical position.

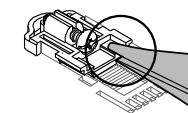

2. WIRING



WARNING

To prevent electric shock or instrument failure, do not turn on the power until all wiring is completed. Make sure that the wiring is correct before applying power to the instrument.

2.1 Wiring Cautions

- For thermocouple input, use the appropriate compensation wire.
- For RTD input, use low resistance lead wire with no difference in resistance between the three lead wires.
- To avoid noise induction, keep input signal wire away from instrument power line, load lines and power lines of other electric equipment.
- If there is electrical noise in the vicinity of the instrument that could affect operation, use a noise filter.
 - Shorten the distance between the twisted power supply wire pitches to achieve the most effective noise reduction.
 - Always install the noise filter on a grounded panel. Minimize the wiring distance between the noise filter output and the instrument power supply terminals to achieve the most effective noise reduction.
 - Do not connect fuses or switches to the noise filter output wiring as this will reduce the effectiveness of the noise filter.
- About five seconds are required as preparation time for contact output every time the instrument is turned on. Use a delay relay when the output line is used for an external interlock circuit.
- Power supply wiring must be twisted and have a low voltage drop.
- For an instrument with 24 V power supply, supply power from a SELV circuit.
- A suitable power supply should be considered in end-use equipment. The power supply must be in compliance with a limited-energy circuits (maximum available current of 8 A).
- This instrument is not furnished with a power supply switch or fuse. Therefore, if a fuse or power supply switch is required, install close to the instrument. Recommended fuse rating: Rated voltage 250 V, Rated current 1 A
Fuse type: Time-lag fuse

- Use the solderless terminal appropriate to the screw size.

Screw size:
M3 × 7 (with 5.8 × 5.8 square washer)
Recommended tightening torque:
0.4 N·m (4 kgf·cm)

Applicable wire:
Solid/twisted wire of 0.25 to 1.65 mm²
Specified dimension: Refer to Fig. 6

Specified solderless terminals:
Manufactured by J.S.T MFG CO., LTD.
Circular terminal with isolation V1.25-MS3
(M3 screw, width 5.5 mm, hole diameter 3.2 mm)

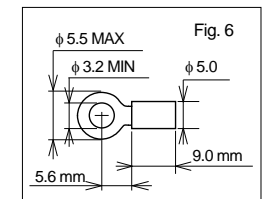

- Make sure that the any wiring such as solderless terminal is not in contact with the adjoining terminals.
- Up to two solderless terminal lugs can be connected to one terminal screw, then refer to figure 7. However, in this case, reinforced insulation cannot be used.

Fig. 7: Image of how to bend each solderless terminal lug

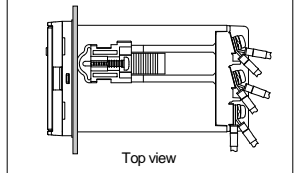

- If solderless terminal lugs other than those in not recommended dimensions are used, terminal screws may not be tightened. In such a case, bend each solderless terminal lug in advance and then conduct wiring. If the terminal screw is forcibly tightened, it may be damaged.

- When two solderless terminal lugs are connected to one terminal screw, terminal cover cannot be used.

- For isolated device input/output blocks, refer to the following:

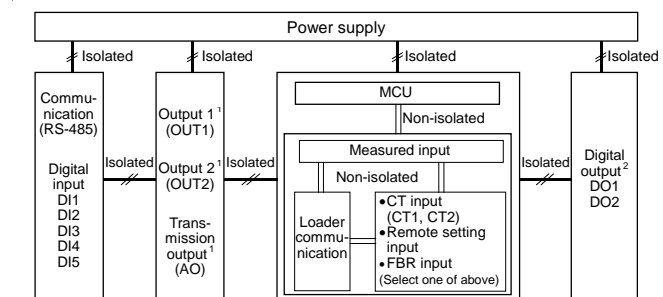

¹ Outputs are isolated if output 1 (OUT1) or output 2 (OUT2) is "relay contact output" or "triac trigger output." If both outputs are "relay contact output" or "triac trigger output," outputs are not isolated.

² Digital outputs (relay contact output type only) are not mutually isolated.

