

---

---

---

---

---

---

*Handheld Digital  
Thermometer*

***DP-700***

***Instruction Manual***

- Microsoft®, Windows®, Excel are the registered trademark of Microsoft Corporation.
- Company names and product names used in this manual are the trademarks or registered trademarks of the respective companies.

Thank you for purchasing this RKC product. In order to achieve maximum performance and ensure proper operation of your new instrument, carefully read all the instructions in this manual. Please place the manual in a convenient location for easy reference.

## SYMBOLS

**WARNING** : This mark indicates precautions that must be taken if there is danger of electric shock, fire, etc., which could result in loss of life or injury.

**CAUTION** : This mark indicates that if these precautions and operating procedures are not taken, damage to the instrument may result.



: This mark indicates that all precautions should be taken for safe usage.



: This mark indicates important information on installation, handling and operating procedures.



: This mark indicates supplemental information on installation, handling and operating procedures.



: This mark indicates where additional information may be located.



### WARNING

- Never use this product for medical equipment.
- This product must be used in accordance with the specifications to prevent fire or damage to instrument and equipment.
- This product is not intended for use in locations subject to flammable or explosive gases.
- If any abnormality such as smoke, smell of burning or noise was found, do not use the product. If so, fire may occur.
- RKC is not responsible if this product is repaired, modified or disassembled by other than factory-approved personnel. Malfunction can occur and warranty is void under these conditions.

## CAUTION

- All precautions described in this manual should be taken to avoid damage to the instrument or equipment.
- Prevent metal fragments or lead wire scraps from falling inside instrument case to avoid electric shock, fire or malfunction.
- Do not drop nor apply strong impact to the product. If so, failure may result.
- Do not use the product while the battery cover is being removed. If so, failure may result.
- Load a battery so that its polarity will meet the indication on the product. If not, the battery electrolyte may leak or heat be generated to result in injury or failure.
- If the product is not used for a long period of time, remove the battery from the mainframe. If not, the battery electrolyte may leak to result in failure.
- Battery service life may change depending on battery performance, operating condition and measuring environment.
- Use this product within the following ambient temperature and ambient humidity.
  - Allowable ambient temperature:  $-20$  to  $+50$  °C
  - Allowable ambient humidity: 5 to 95 %RH(Absolute humidity: MAX.W.C  $29.3 \text{ g/m}^3$  dry air at 101.3 kPa)
- Do not use or store the product in places such as listed below:
  - Rapid changes in ambient temperature which may cause condensation.
  - Corrosive or inflammable gases.
  - Direct vibration or shock to the mainframe.
  - Direct water, oil, chemicals, vapor or steam splashes. \*
  - Excessive dust, salt or iron particles. \*
  - Excessive induction noise, static electricity, magnetic fields or noise.
  - Direct air flow from an air conditioner.
  - Exposure to direct sunlight.
  - Excessive heat accumulation.

\* DP-700A: Equal to IP67, DP-700B: Equal to IP54
- Turn off the power supply before cleaning the instrument.
- Do not use a volatile solvent such as paint thinner to clean the instrument. Deformation or discoloration will occur. Use a soft, dry cloth to remove stains from the instrument.
- To avoid damage to instrument display, do not rub with an abrasive material or push front panel with a hard object.

## NOTICE

- This manual assumes that the reader has a fundamental knowledge of the principles of electricity, process control, computer technology and communications.
- The figures, diagrams and numeric values used in this manual are only for purpose of illustration.
- RKC is not responsible for any damage or injury that is caused as a result of using this instrument, instrument failure or indirect damage.
- RKC is not responsible for any damage and/or injury resulting from the use of instruments made by imitating this instrument.
- Periodic maintenance is required for safe and proper operation of this instrument. Some components have a limited service life, or characteristics that change over time.
- Every effort has been made to ensure accuracy of all information contained herein. RKC makes no warranty expressed or implied, with respect to the accuracy of the information. The information in this manual is subject to change without prior notice.
- No portion of this document may be reprinted, modified, copied, transmitted, digitized, stored, processed or retrieved through any mechanical, electronic, optical or other means without prior written approval from RKC.

# CONTENTS

---

	Page
<b>1. OUTLINE .....</b>	<b>1</b>
1.1 Checking the Product .....	1
1.2 Parts Description .....	2
1.3 LCD Displays .....	3
1.4 Function Menu Configuration.....	4
<b>2. PREPARATION BEFORE USE .....</b>	<b>5</b>
2.1 Loading Battery.....	5
2.2 Setting Date and Time .....	6
2.3 Connecting the Temperature Sensor .....	7
<b>3. BASIC OPERATION .....</b>	<b>8</b>
3.1 Turn Power On .....	8
3.2 Measuring Temperatures.....	9
<b>4. JUDGING MEASURED TEMPERATURES [SIMPLIFIED JUDGING FUNCTION] .....</b>	<b>10</b>
4.1 Registering Tag Names (Measured Objects).....	11
4.2 Setting the Judgment Range of High/Low Limit Temperatures.....	14
4.3 Judging Measured Temperatures.....	15
<b>5. RECORDING MEASURED TEMPERATURES [LOGGING FUNCTION] .....</b>	<b>17</b>
5.1 Manual Recording .....	18
5.2 Automatic Recording .....	19
5.3 Retrieving Recorded Data .....	21
5.3.1 Retrieving only recorded data with specified tag name (Tag Filter) .....	21
5.3.2 Retrieving recorded data with specified log registered No. (Log Jump).....	22
5.4 Deleting Recorded Data .....	23
5.4.1 Deleting only one recorded data item (Delete?).....	23
5.4.2 Deleting all recorded data items (All Clear?).....	24
5.5 Defragmenting Recorded Data .....	25
<b>6. PEAK HOLD/BOTTOM HOLD .....</b>	<b>26</b>

	Page
<b>7. REGISTERING USER NAMES [ONLY FOR DP-700B].....</b>	<b>28</b>
<b>8. INITIAL SETTING .....</b>	<b>32</b>
■ To select the display language (English/Japanese) .....	32
■ To select the date format .....	32
■ To select the sensor type .....	33
■ To select the display unit (°C/°F) .....	33
■ To select the decimal point position .....	34
■ To correct the temperature display value (PV Bias) .....	34
■ To lessen the fluctuation of a display value caused by noise (Digital Filter)...	35
■ Saving battery consumption (Auto Power OFF) .....	35
■ Locking/Unlocking setting operation (Operation Lock) .....	36
<b>9. MANAGING DATA BY PC [ONLY FOR DP-700B].....</b>	<b>37</b>
9.1 Connecting PC to DP-700B .....	37
9.2 Storing Data.....	38
9.3 Disconnecting DP-700B from PC .....	41
<b>10. APPENDIX .....</b>	<b>42</b>
10.1 Replace the Battery .....	42
10.2 Cleaning .....	44
10.3 Troubleshooting .....	44
10.3.1 Error displays .....	44
10.3.2 Problem and solution .....	46
10.4 Specifications .....	47

# 1. OUTLINE

---

This Chapter describes features, package contents and model code, etc. The handheld digital thermometer DP-700 has the following features:

## ■ Wide temperature measurement is possible

Thermocouple K: -200 to +1372 °C (-328 to +2501 °F), -199.9 to +999.9 °C (°F)

Thermocouple J: -200 to +1200 °C (-328 to +2192 °F), -199.9 to +999.9 °C (°F)

Thermocouple T: -50 to +400 °C (-58 to +752 °F), -50.0 to +400.0 °C (-58.0 to +752.0 °F)

RTD (Pt100): -200 to +850 °C (-328 to +1562 °F), -199.9 to +850.0 °C (-199.9 to +999.9 °F)

## ■ Names of measured objects can be registered.

Names of measured objects can be registered using 11 characters maximum.

(DP-700A: maximum 5 tags DP-700B: maximum 99 tags)

## ■ Simplified Judging Function

Judgment can be immediately made for each measured object. (Temperatures to judge the high/low limits need to be set.)

## ■ Logging Function (Manual logging mode, Automatic logging mode)

Measured object, measured temperature, date, and user name can be manually or automatically recorded in the memory. (DP-700A: maximum 99 logs DP-700B: maximum 9999 logs)

## ■ Peak and Bottom Hold Function

The maximum and minimum measured-temperatures can always be stored.

## ■ Can be operated for 400 hours continuously using one Type LR6 (based on IEC and JIS) alkaline battery.

## ■ Data can be controlled using personal computers (Only for the DP-700B)

Measured data can be stored in the file in the CSV format using the USB port of each personal computer.

## 1.1 Checking the Product

Before using this product, check each of the following:

- Model code
- Check that there are no scratch or breakage in external appearance.
- Check that all of the items delivered are complete. (Refer to below)

### ■ Model code

DP-700 □/□

(1) (2)

(1) Type

A: Economy type

(No USB, Logging: 99 logs, Backed up by SRAM)

B: High performance type

(With USB, Logging: 9999 logs, Backed up by EEPROM)

(2) Display language

J: Japanese

E: English

### Accessories:

- |   |  |
|---|--|
| <input type="checkbox"/> Instruction Manual (IMR01X01-E3) ... 1 | <input type="checkbox"/> LR6 (IEC and JIS) Alkaline battery..... 1 |
| <input type="checkbox"/> Strap ..... 1                          | <input type="checkbox"/> USB cable (Only for DP-700B) ..... 1      |



If any of the products are missing, damaged, or if your manual is incomplete, please contact RKC sales office or the agent.

## 1.2 Parts Description

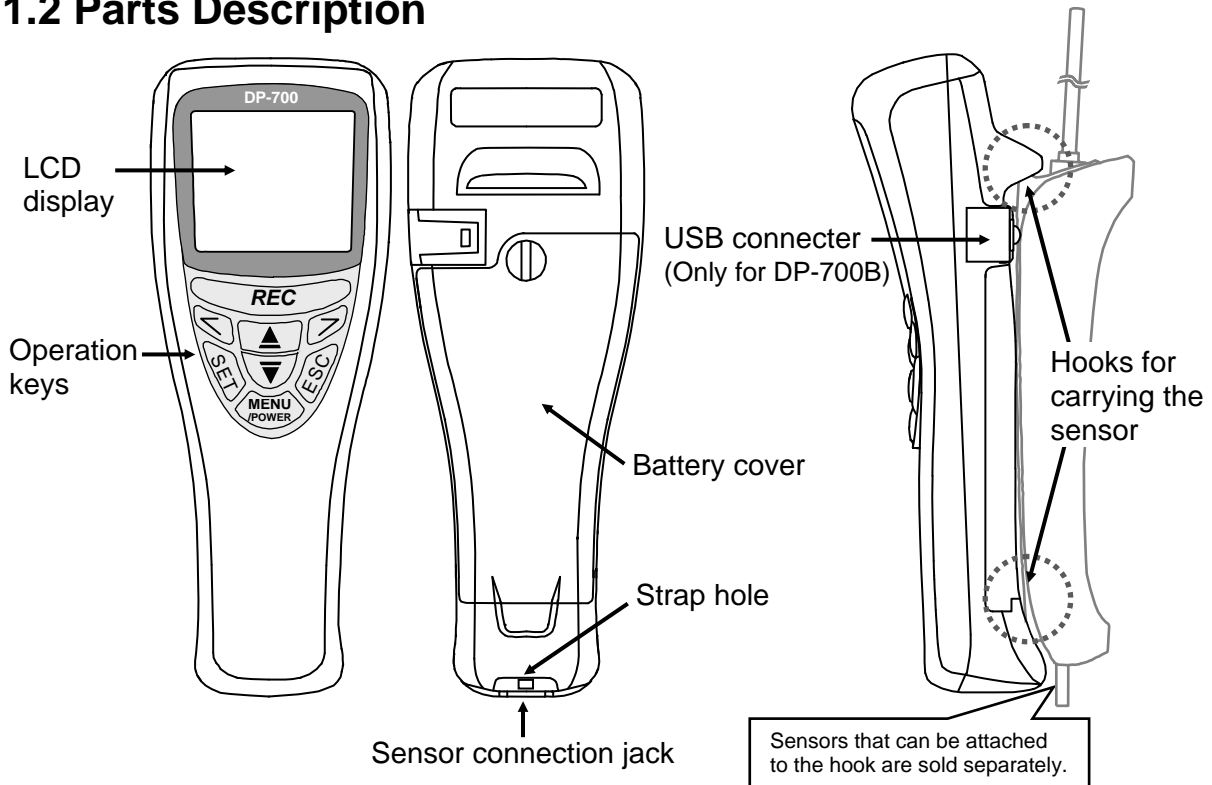

### LCD display

Displays various information on measured temperature, measured date, set details of each function and error number.

### Operation keys

**MENU/POWER key:**

- Used to turn on/off the power. Pressing this key for more than 2 seconds can turn off the power.
- Can call up or select the function menu screen while the power is turned on.
- Can display the list of characters in the message column while characters are being entered.

**SET key:**

- Establishes operation during execution.

**ESC key:**

- Suspends operation during execution. If suspended, returns to the displayed state or screen just before being suspended.

**UP key (▲)/DOWN key (▼):**

- Can select measured objects or user names already registered while the measurement screen is being displayed.
- Can select the list of characters while characters are being entered.

**Left shift key (<)/Right shift key (>):**

- Can select display details in the message column while the measurement screen is being displayed.
- Can move to the preceding or next function menu screen while the function menu (Fn0 to Fn9) screen is being displayed.
- Can move the cursor character by character while characters are being entered.

**REC key:**

- When in manual logging mode (manual recording), records the measured temperature and date at the time when this key is pressed.
- When in automatic logging mode (automatic recording), used as a recording START/STOP key.



## 1.3 LCD Displays

The following details are displayed on the LCD screen.

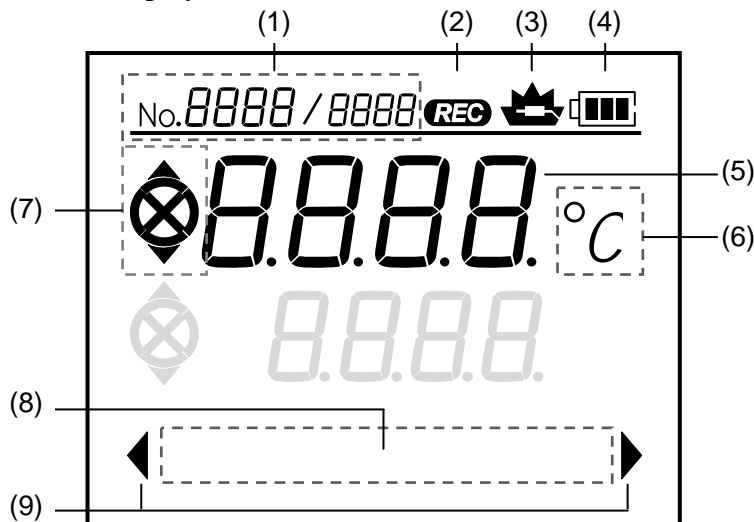

### (1) No. 8888 / 8888 (Number display)

- If measured object or user name is displayed, displays the corresponding registered number.
- When recorded data items are displayed, displays “Display memory number/Total memory number of recorded data items of those data items.

### (2) REC (Log execution display)





- When in manual logging mode (manual recording), displayed only when the REC key is pressed.
- When in automatic logging mode (automatic recording), continues lighting during recording and continues flashing during recording stop.

### (3) (Burnout display)

Displayed when the sensor is broken, shorted or imperfectly connected.

### (4) (Remaining battery service life display)

Displays the remaining battery service life (reference only).

	Service life remains long.
	Service life is going to shorten.
	Service life is going to expire. (Battery replacement is required.)
	Service life has expired. (Immediate battery replacement is required.)



### (5) Measured temperature display

Displays the measured temperature. In addition, displays information on error number, etc. if an error occurs.

### (6) °C or °F (Temperature unit display)

### (7) (Simplified judgment display)

Symbols to judge the measured temperature. To judge the measured temperature using these symbols, it is necessary to set the judgment points of its high and low limits.

	NG	Measured temperature exceeds judgment point of high limit temperature.
	OK	Measured temperature is within judgment points.
	NG	Measured temperature is below judgment point of low limit temperature.

### (8) Message column

Displays function menu screen name, measured date<sup>1</sup>, measured object<sup>3</sup>, user name<sup>2,3</sup> etc.

<sup>1</sup> Set the measured date, if necessary. (Refer to P. 6)

<sup>2</sup> Not displayed if no user name is registered.

<sup>3</sup> Number of registered characters: 11 maximum

### (9) ,

Displays message selection.

## 1.4 Function Menu Configuration

The DP-700 is provided with a function menu used to select and then set any function necessary for measured-temperature judgment and recording (logging). There for, set the desired function as needed by the customer. For details, refer to the relevant pages.

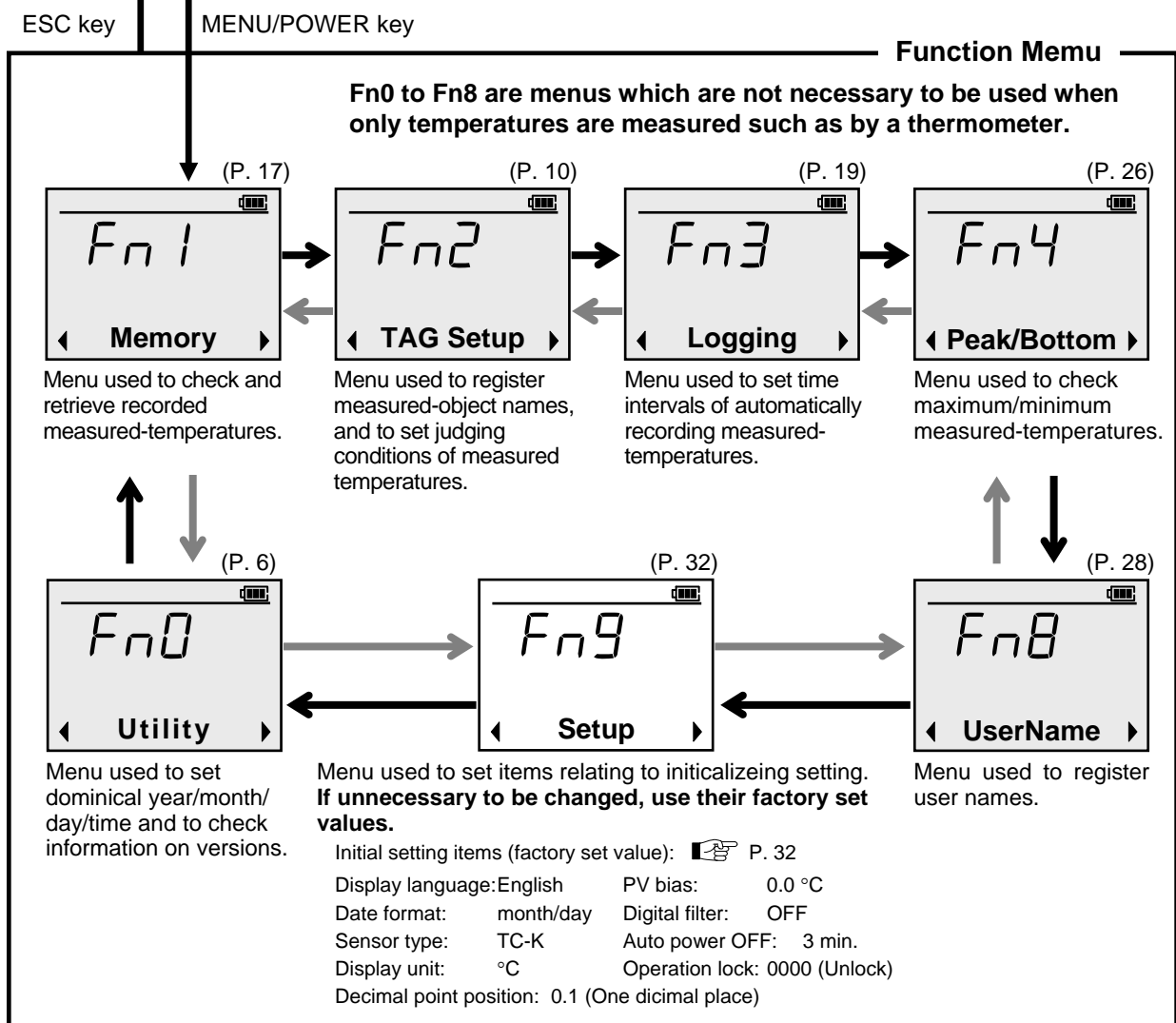
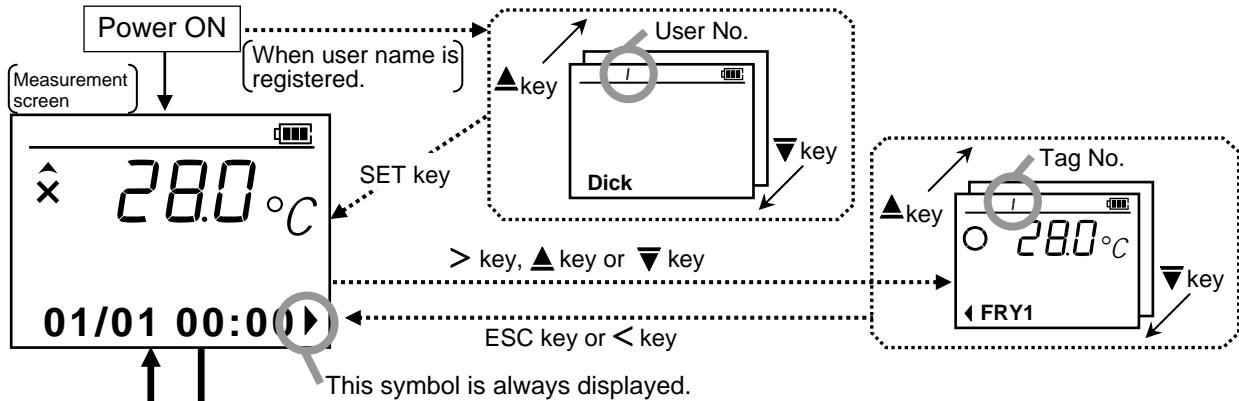

➡ : Press the MENU/POWER key or > key

➡ : Press the < key

## 2. PREPARATION BEFORE USE

This chapter describes preparations necessary for operating this instrument for the first time.

### 2.1 Loading Battery

#### ■ Procedures

1. Loosen the battery cover.

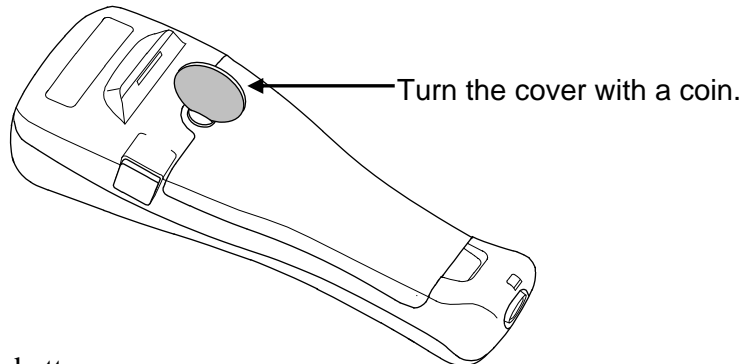

2. Remove the battery cover.
3. Load a battery without mistaking its polarity.

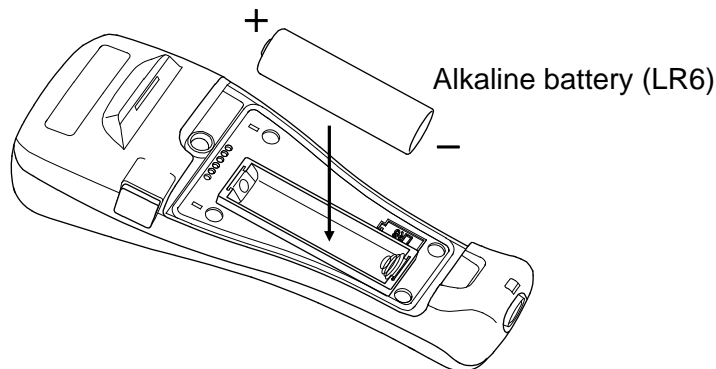

4. Then, firmly tighten the battery cover.



**Insufficient tightening cannot assure the effect of water resistance (DP-700A: Equal to IP67, DP-700B: Equal to IP54).**



After the battery is loaded, the instrument is ready to be reset-started.

The function menu “**Utility (Fn0)**” for setting the dominical year is displayed on the LCD screen. **If no dominical year is set, no calendar function can be used. Always set the year if the calendar function is used.**



Year setting screen

Pressing the ESC key twice can display the measurement screen.



For the battery life or replace method, refer to **10.1 Replace the Battery (P. 42)**.

## 2.2 Setting Date and Time

Set the date and time displayed on the measurement screen. This setting is made on the function menu “Utility (Fn0).” The setting procedure is described using an example where the instrument is reset-started (from start on the Fn0 screen).

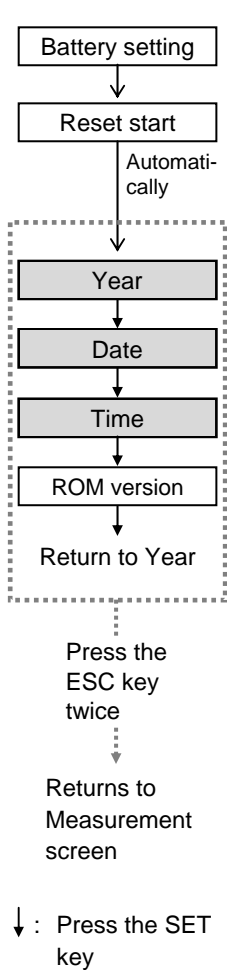

### ■ Setting year

1. Press the < or > key to move the flashing digit.
2. Press the ▲ or ▼ key to set the “year.”
3. Press the SET key to store the new set value.

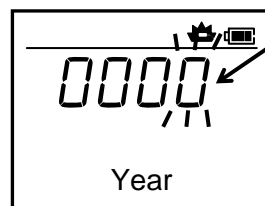

Flashing

Data range: 0000 (Only for Reset start)  
2003 to 9999

Factory set value: 0000

### ■ Setting month and day

1. Press the ▲ or ▼ key to set the “day (month).”
2. Press the < key to move the blinking cursor to “month (day).”
3. Press the ▲ or ▼ key to set the “month (day).”
4. Press the SET key to store the new set value.

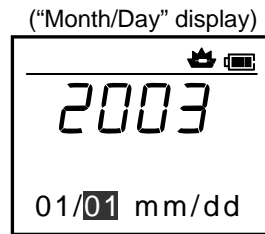

(“Month/Day” display)

↑ ↑  
Month Day (Cursor blinking)

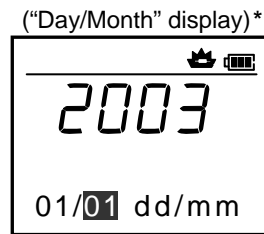

(“Day/Month” display)\*

↑ ↑  
Day Month (Cursor blinking)

Data range:  
Month: 01 to 12  
Day: 01 to 31  
Factory set value:  
01/01 (Month/Day)

\* To display “Day/Month,” refer to the date format screen in “Setup (Fn9)” of the Function menu (P. 32).

### ■ Setting time

1. Press the ▲ or ▼ key to set the “minute.”
2. Press the < key to move the blinking cursor to “time.”
3. Press the ▲ or ▼ key to set the “time.”
4. Press the SET key to store the new set value.



Data range: Hour: 00 to 23  
Minute: 00 to 59

Factory set value: 00:00

Cursor blinking

---

## 2.3 Connecting the Temperature Sensor

Connect the temperature sensor (sold separately) to the DP-700 mainframe.



**Firmly connect the sensor cable to the mainframe so as not to cause imperfect contact.**

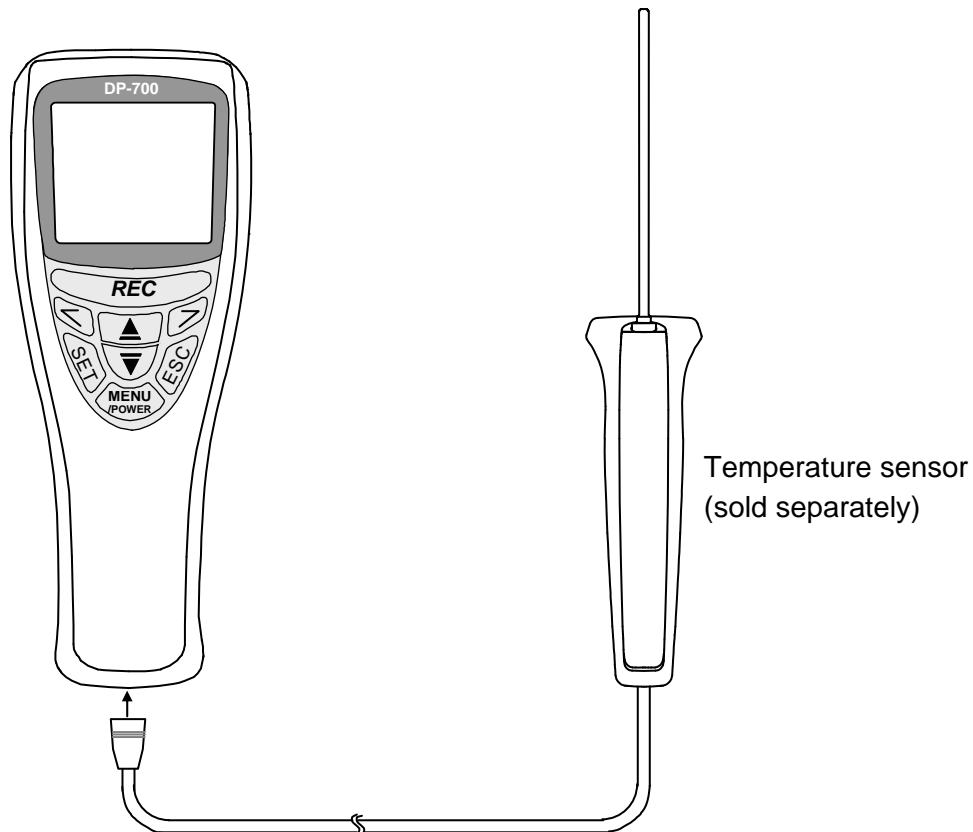

### ■ Temperature sensor (sold separately)

Temperature sensors for DP-700 are sold separately.



Contact with RKC office or the agent for details of temperature sensors.

### ■ A-DP700 [Converter plug for “3C/2C to 6C”] (sold separately)

This is a converter plug for RKC’s temperature sensors with 3C or 2C plug for use with DP-700.

## 3. BASIC OPERATION

This chapter describes the basic operation of the instrument for temperature measurement.

### 3.1 Turn Power On

Press the MENU/POWER key. The power is turned on to display the measurement screen.

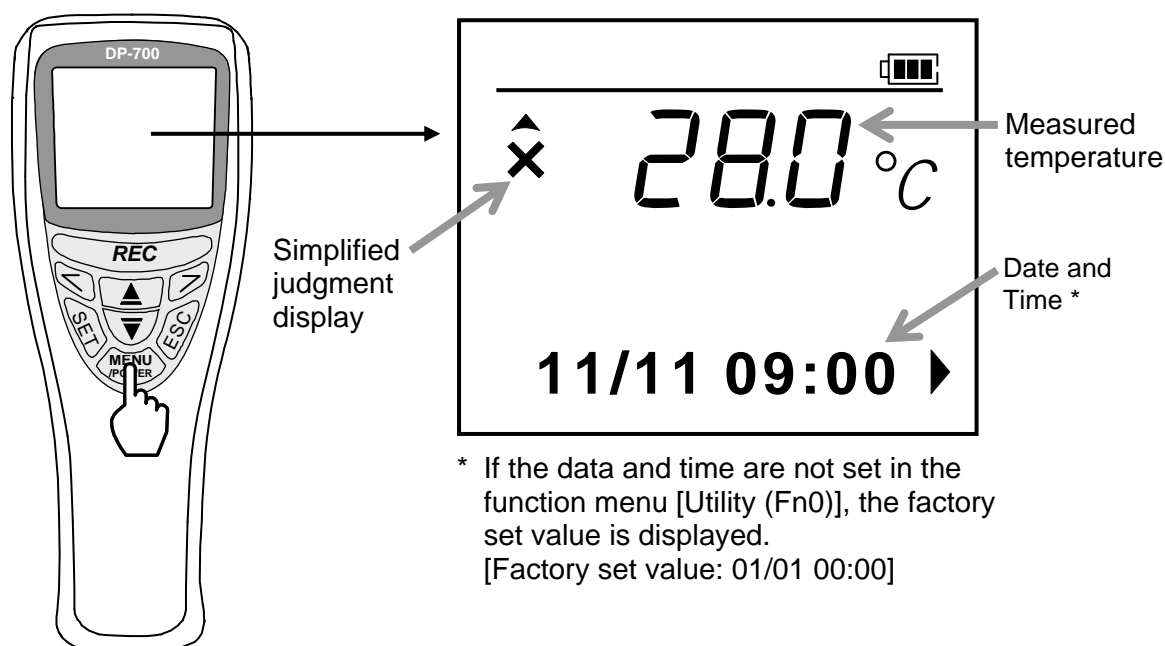

When the power is turned on for the first time after preparations before operation are finished, “Simplified judgment display” is as the above screen example.

For the simplified judgment display, refer to **4. JUDGING MEASURED TEMPERATURES [SIMPLIFIED JUDGING FUNCTION] (P. 10)**.

The power is turned off if no key operation is performed for more than the Auto power OFF time (factory set value: 3 min.) with the power turned on.

For the Auto power OFF setting, refer to **Saving battery consumption (P. 35)**.

**How to power off DP-700?**

Press and hold the MENU/POWER key for 2 seconds or more.

**What screen is displayed when the power is turned off and then is turned on again?**

If the user name is registered to the user number selected, the type of screen displayed first differs.

For the type of screen displayed, refer to **1.4 Function Menu Configuration (P. 4)**.

## 3.2 Measuring Temperatures

To measure temperatures, insert the sensor into or contact it with the measured object. When measuring temperatures, handle the sensor as instructed in the following.



### WARNING

- In order to prevent injuries, never direct the sensor tip toward a person.
- In order to prevent burning or frostbite, do not touch the sensor during or just after its use in the high or low temperature environment.

### CAUTION

- Use the sensor within its temperature measuring range.
- Firmly insert the sensor cable into the sensor connector of the mainframe.
- If the sensor gets stained, wipe it with a clean cloth.

#### Example of display screen during measurement:

When a measured object is at a surface temperature of 90.0 °C

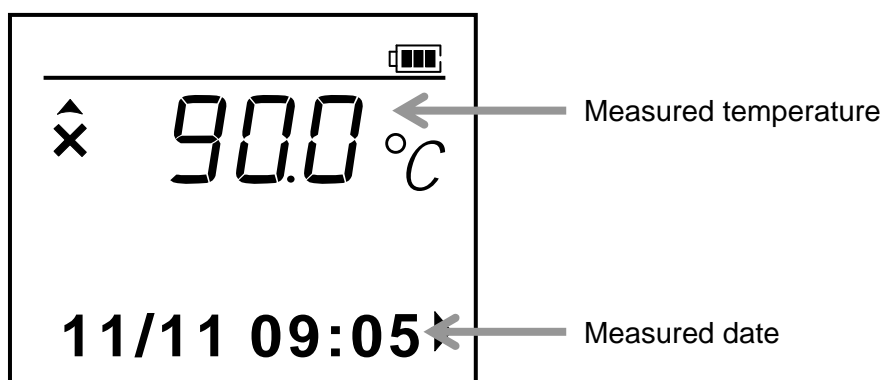

It is possible to record the measured temperature and date in the memory.



For the data recording (logging) method, refer to **5. RECORDING MEASURED TEMPERATURES [LOGGING FUNCTION] (P. 17)**.

# 4. JUDGING MEASURED TEMPERATURES [SIMPLIFIED JUDGING FUNCTION]

This chapter describes settings and procedures to judge measured temperatures using the simplified judging function.

Before using the simplified judging function, register tag names (measured object names) and also set judgment criteria (judgment points of high and low temperatures). The registration and setting are made on the function menu “TAG Setup (Fn2).”

## What is the simplified judging function?

This function is for judging whether or not measured temperatures are within the judgment criteria preset (judgment points of high and low temperatures) and then check judgment results according to simplified judgment symbols.

Screen Configurations of TAG Setup (Fn2) Menu:

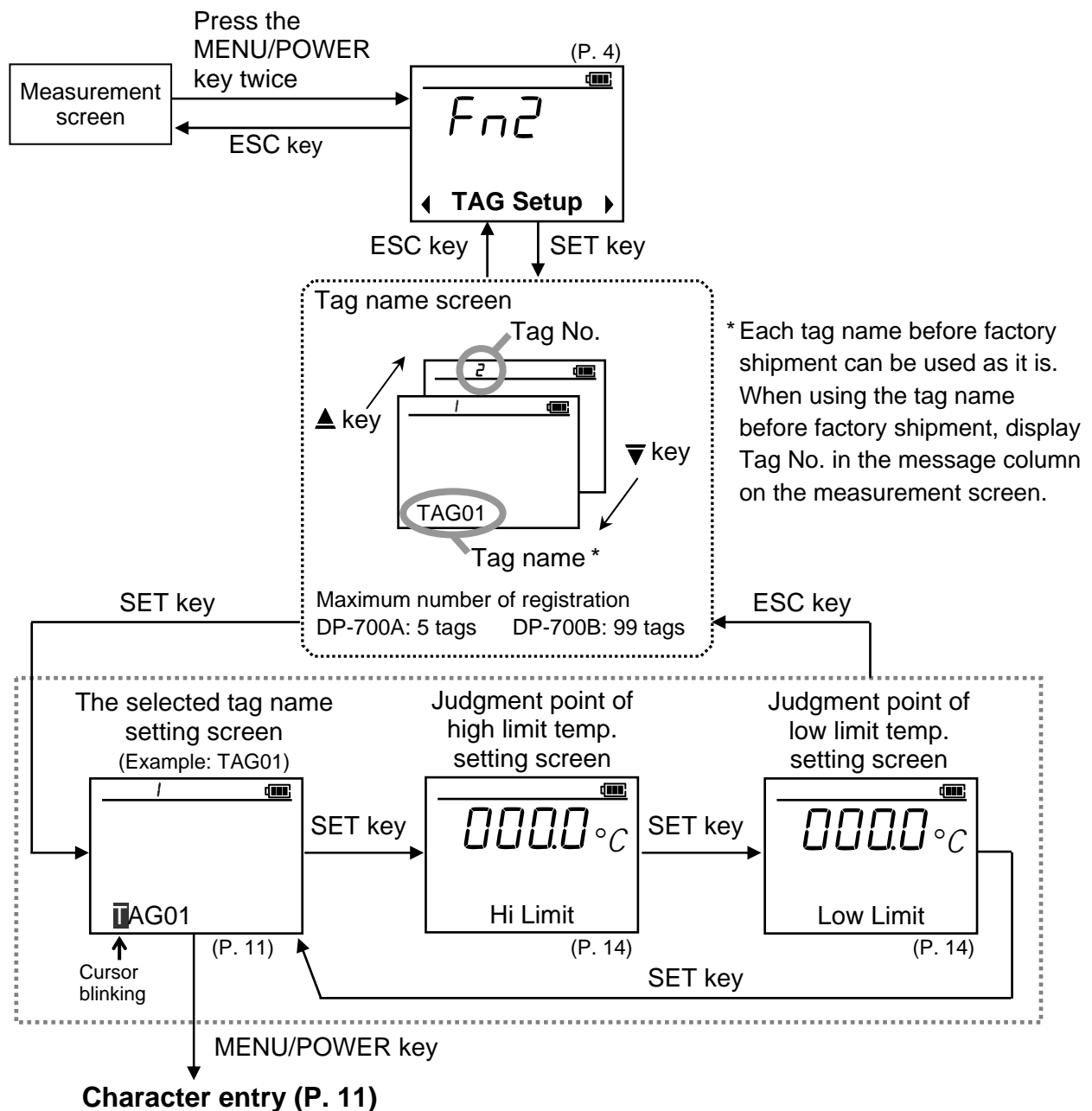





■ **Procedures**

**Example: Change the tag name of Tag No. 2 from “TAG02” to “PAN02”**

1. Press the SET key at TAG Setup (Fn2) screen to display the tag name screen.



2. Press the ▲ key.  
The display goes to the tag name screen of Tag No. 2.

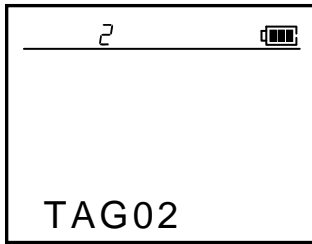

3. Press the SET key.  
The cursor is displayed in the position displayed with the tag name “T.”

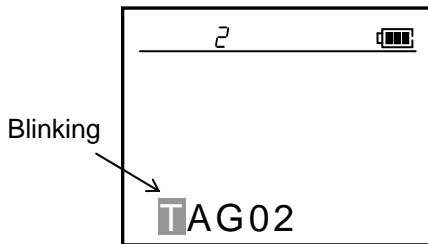

4. Press the MENU/POWER key.  
The list of characters is displayed in the message column.



5. Press the ▲ key.  
The list of characters including “P” is displayed.



6. Press the > key to move the cursor to the position displayed with “P.”

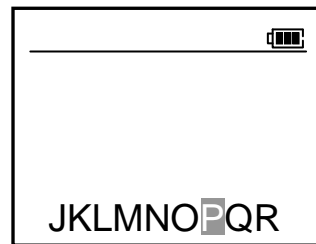

7. Press the SET key to store the new set value. The screen returns to the tag name screen of Tag No. 2 and the cursor moves to “A.”

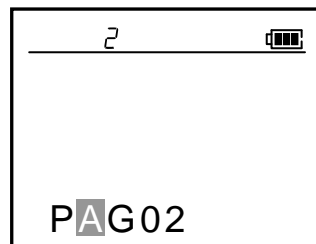

8. Press the > key to move the cursor to the position displayed with “G.”

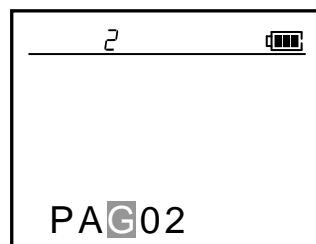

**9.** Press the MENU/POWER key.

The list of characters is displayed in the message column.

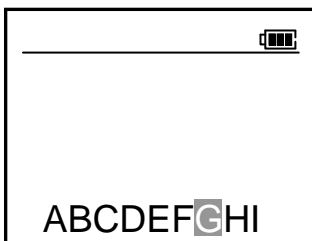
**10.** Press the ▼ key.

The list of characters including “N” is displayed.

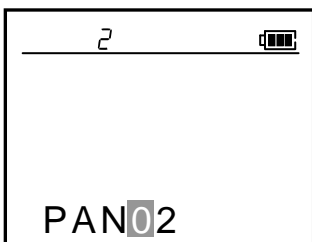
**11.** Press the < key to move the cursor to the position displayed with “N.”**12.** Press the SET key to store the new set value. The screen returns to the tag name screen of Tag No.2 and the cursor moves to “0.”

The setting is finished.

**When setting the judgment criteria (judgment points of high and low temperatures) succeedingly, press the SET key. (P. 14)**

 To return to the measurement screen, press the ESC key three times.

 **How to change the character without displaying the list of characters?**

1. Move the cursor to the position displayed with the character to be revised by using the < or > key.
2. Display the character to be revised by using the ▲ or ▼ key.

 **How to delete one character?**

1. Move the cursor to the position displayed with the character to be deleted using the < or > key.
2. Press the MENU/POWER key twice to display the screen for checking the deletion.
3. Press the SET key to delete the character where the cursor blinked.

 **How to insert space for entering a character in any position?**

1. Move the cursor to the position where a character needs to be entered using the < or > key.
2. Press the MENU/POWER key three times to display the screen for checking the entry.
3. Press the SET key to insert space for entering the character before the character position where the cursor blinks.

## 4.2 Setting the Judgment Range of High/Low Limit Temperatures

Set the judgment points of high and low temperatures for judging measured temperatures. This setting is made for each tag name. This judgment is conducted from the time when measurement is started.

### ■ Procedures

**Example: When setting a high temperature of 90.0 °C and a low temperature of 50.0 °C for Tag No. 2 (tag name: PAN02)**

1. Press the SET key at the tag name screen of Tag No. 2 to display the judgment point of high limit temperature setting screen.

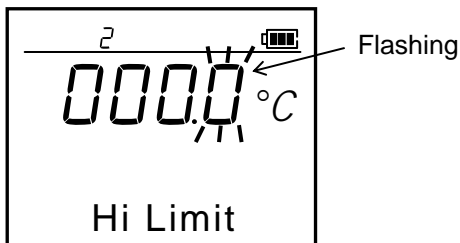

2. Press the < key to flash the tens digits.

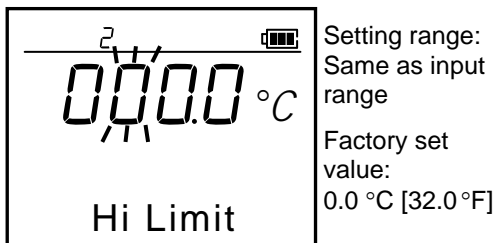

3. Press the ▲ key to change the number to "9."

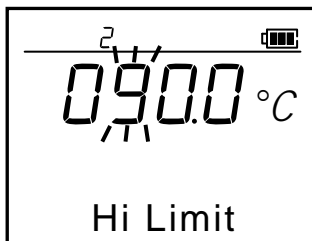

4. Press the SET key to store the new value. The display goes to the next screen (Judgment point of low limit temperature).

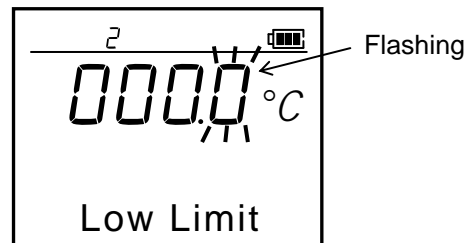

5. Press the < key to flash the tens digits.

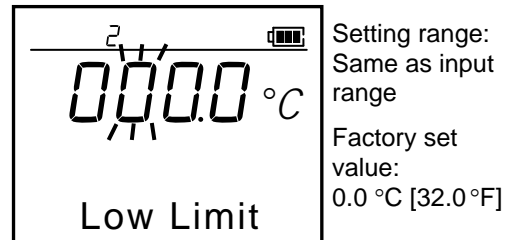

6. Press the ▲ key to change the number to "5."

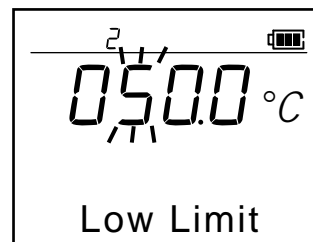

7. Press the SET key to store the new set value. The display returns to the tag name screen of Tag No. 2.

The setting is finished.

 To return to the measurement screen after the setting is finished, press the ESC key three times.

### 4.3 Judging Measured Temperatures

The judgment criteria of a measured temperature is described by referring to the following example.

- Measured object: Hot water
- Tag number: 2 (tag name: PAN02)
- Judgment criteria: Judgment point of high limit temperature 90.0 °C  
 Judgment point of low limit temperature 50.0 °C

#### ■ Procedures

1. Turn on the power. The measurement screen appears on the LCD.
2. Press the > key. Tag name is displayed in the message column.  
 First check whether or not a displayed screen is for the tag name of Tag No.2. If not, press the ▲ or ▼ key to select the tag name of Tag No.2.

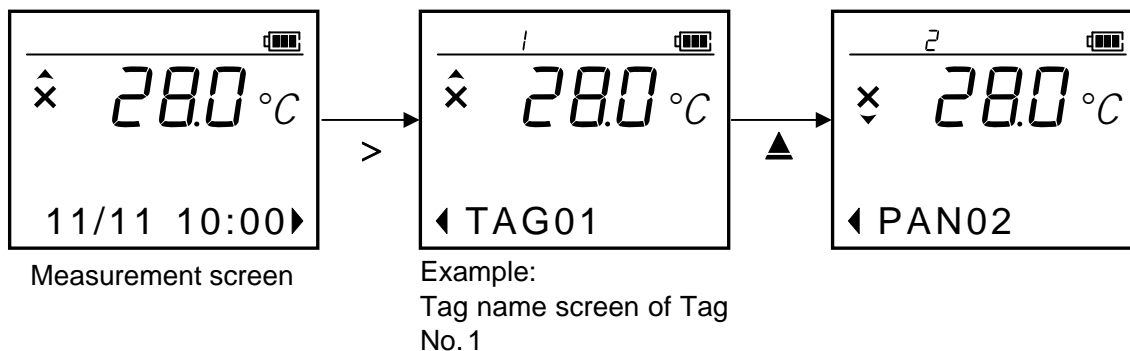

The tag name displayed when the > key is pressed is that with the tag number selected last, which continues to be displayed until the power is turned off.

For example, if the tag name of Tag No.5 is selected last, the tag name of Tag No.5 is displayed in the message column when selected to the tag name from the measured date.

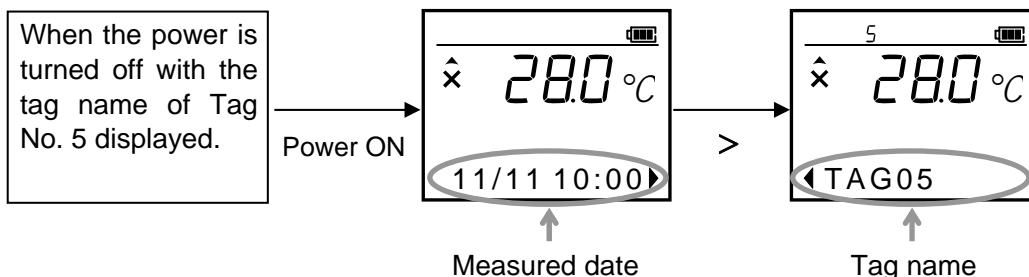

Continued on the next page.

3. Temperatures in a measured object are measured.

- When exceeding the judgment point (90.0 °C) of high limit temperature

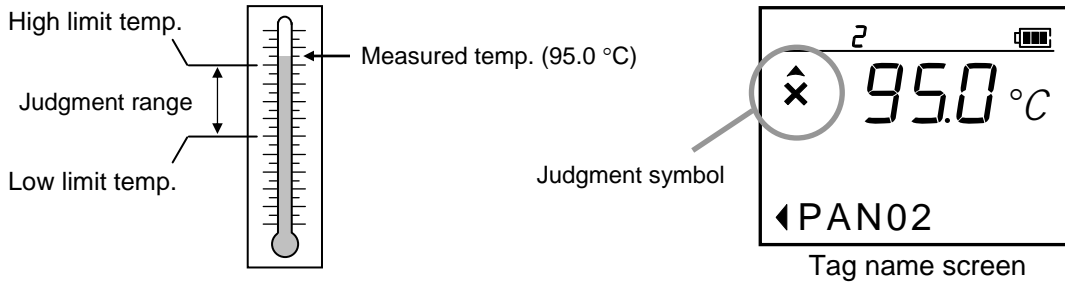

- When falling below the judgment point (50.0 °C) of low limit temperature

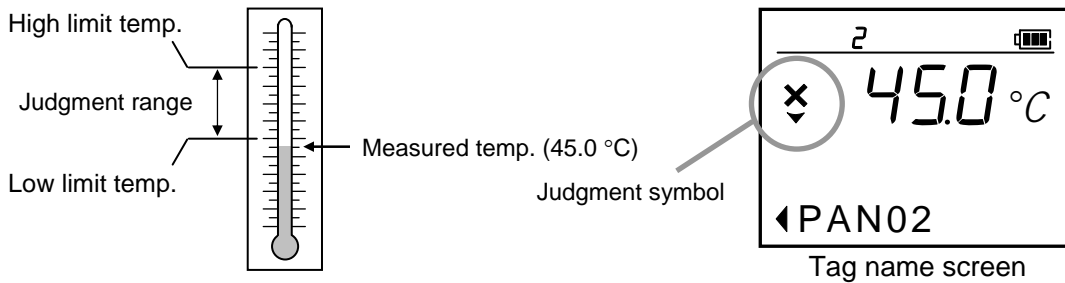

- When within the judgment points (50.0 to 90.0 °C)

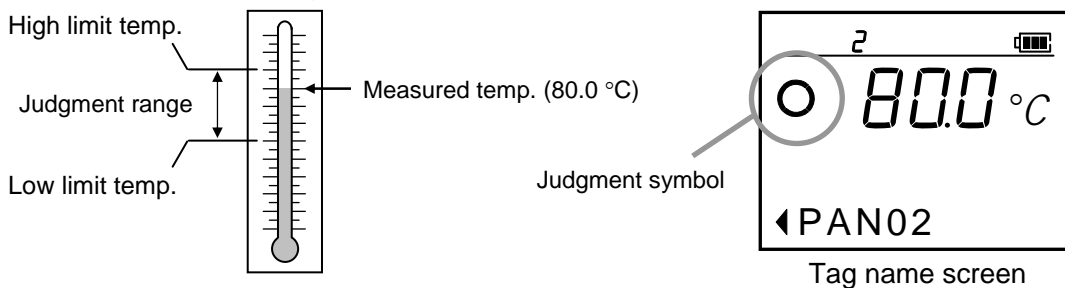

Thus, the judgment of measured temperatures has been finished.

- ☞ When needing to record measured temperatures \* in the memory, refer to **5. RECORDING MEASURED TEMPERATURES [LOGGING FUNCTION] (P. 17)**.

\* No result of judgment can be recorded in the memory.

# 5. RECORDING MEASURED TEMPERATURES [LOGGING FUNCTION]

This chapter describes the procedure for recording measured data in the memory using the logging function.

Both manual recording and automatic recording are available for recording measured data in the memory. The measured data is recorded on the function menu “**Memory (Fn1)**” display screen manually or automatically. The data is recorded in the memory in the order of arrival.

## Screen Configurations of Memory (Fn1) Menu:

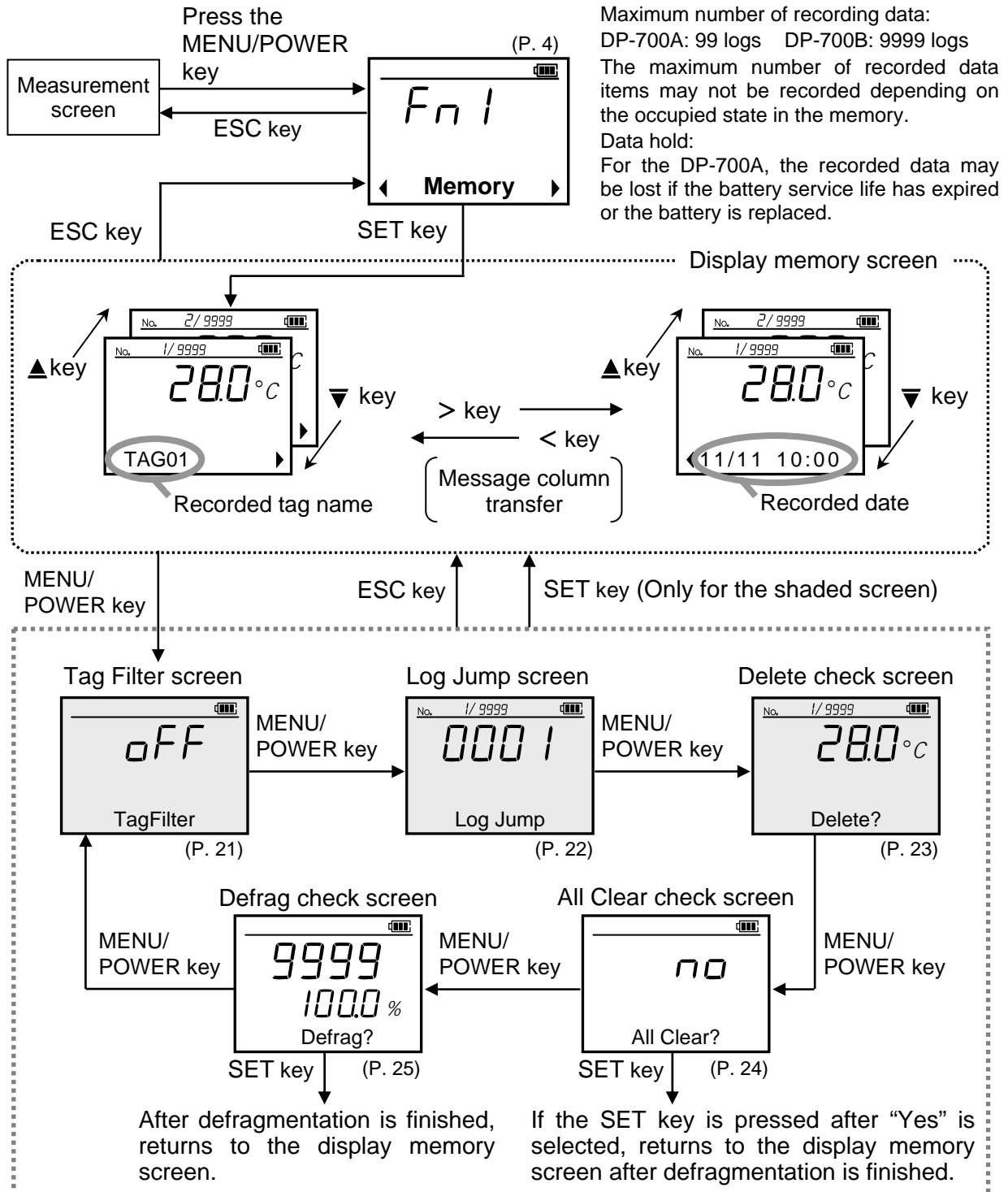

## 5.1 Manual Recording

Measured data \* just when the REC key is pressed is recorded in the memory. Only when the REC key is pressed, **REC** is displayed.

**\* Recordable measured data:**

Measured temperature, Measured date (excluding “Year”), Measured tag No. (tag name), Measured user No.

### ■ Recording

Press the REC key while measured. The measurement result displayed on the screen is recorded in the memory.

**Example: When measured temperatures are recorded on the tag name screen of Tag No. 2**

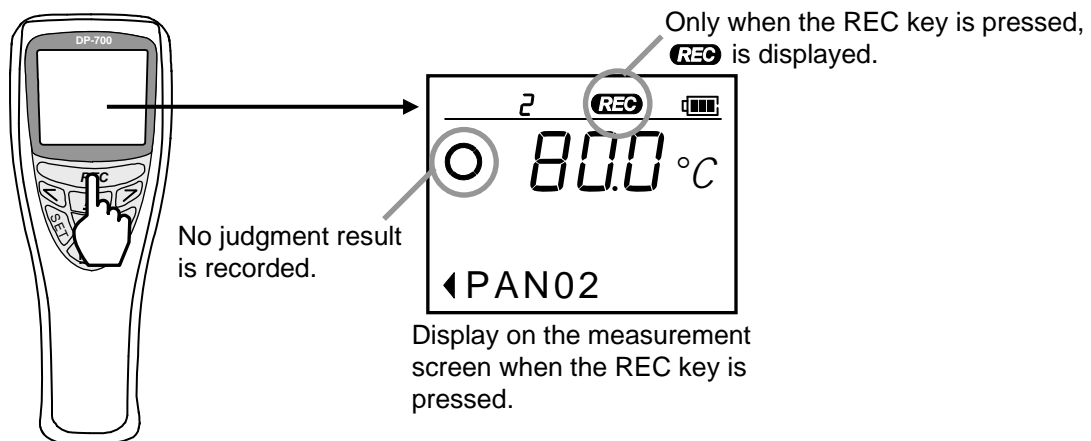

### ■ Checking of recording

Press the MENU/POWER key while displaying the measurement screen to display the Memory (Fn1) screen.

Pressing the SET key displays the recorded measured-data memory screen to be able to check the recorded measured-data.

**Example: When the memory screen in the above example is displayed**

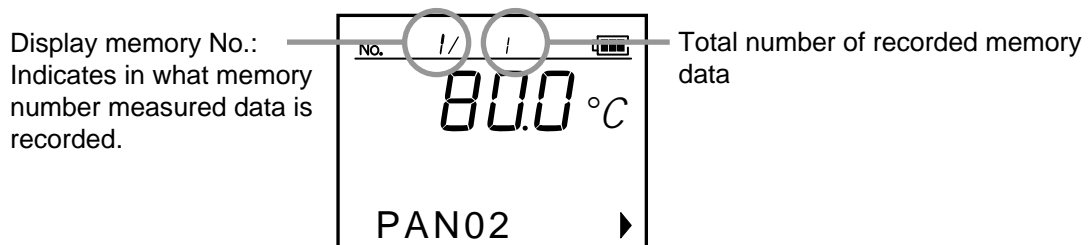

If two or more recorded data items need to be checked in order, press the ▲ or ▼ key.



It is possible to change the display (tag name or recorded date) in the message column. If necessary, press the < or > key.



## 5.2 Automatic Recording

Measured data \* is recorded in the memory at time intervals preset. For automatic measured-data recording, the time interval needs to be set. Set it according to the following procedure.

**\* Recordable measured data:**

Measured temperature, Measured date (excluding “Year”), Measured tag No. (tag name), Measured user No.

### ■ Setting interval time

1. Press the MENU/POWER key three times at the measurement screen to display the function menu “Logging (Fn3)” screen.

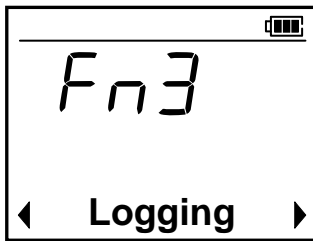

2. Press the SET key.  
The display goes to the interval time setting screen.

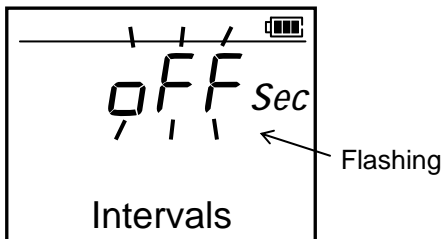

**Interval time:**

Setting range:

OFF (Manual logging)

1 to 3600 seconds (Automatic logging)

Factory set value:

OFF (Manual logging)

3. Set the interval time by the ▲ key and the shift key (<, >).  
(Example: Interval time 15 seconds)

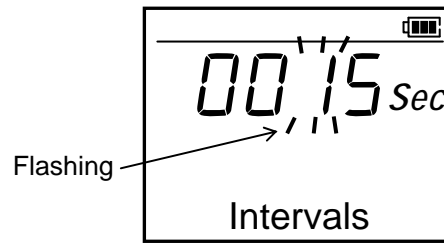

4. Press the SET key to store the new set value. The display returns to the Logging (Fn3) screen. If the interval time is set, **REC** flashes (recording stop).

The setting finished.

 To return to the measurement screen after the setting is finished, press the ESC key.

 **How to cancel the interval time setting?**

Press the ESC key. The display returns to the Logging (Fn3) screen.

■ **Recording**

Press the REC key at the measurement screen. Recording starts at time intervals preset.

**REC** keeps lighting while being recorded.

**Example: When automatic measured-temperature recording is started while the tag name screen of Tag No. 2 is displayed.**

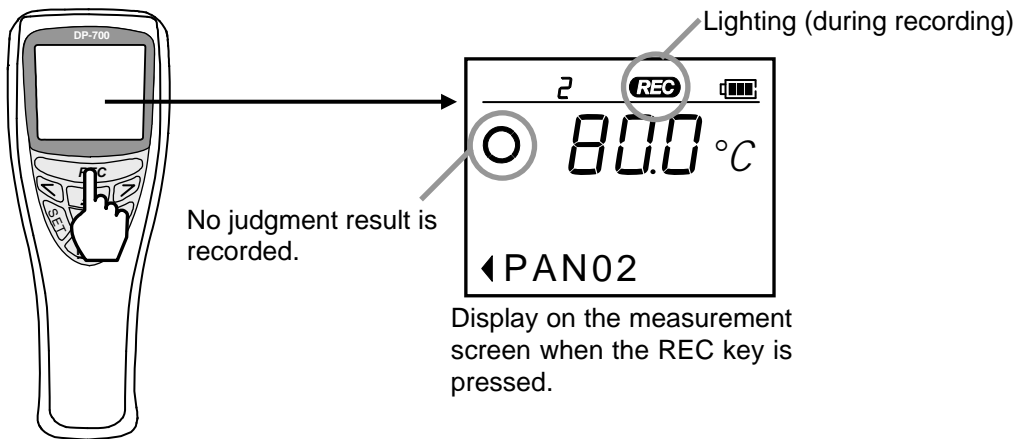

If the power is turned off by pressing the MENU/POWER key or even if the power is turned off by the activation of the Auto power OFF function (P. 35), during recording ( **REC** being lit) data recording continues at time intervals preset.

■ **Recording stop**

Press the REC key. **REC** flashes to stop data recording.

**How to return to manual recording?**

First, stop data recording and then turn the time interval to “OFF.”

For the interval time setting, refer to ■ **Setting interval time (P. 19).**

■ **Checking of recording**

To the checking of recording, refer to **5.1 Manual Recording (P. 18).**

It is also possible to check recorded measured-data by opening the display memory screen while automatic recording is being made.

As the measured data being checked is displayed on the display memory screen, no measured data being recorded is displayed. In this case, the total number of recorded memories is counted every time the data is recorded.

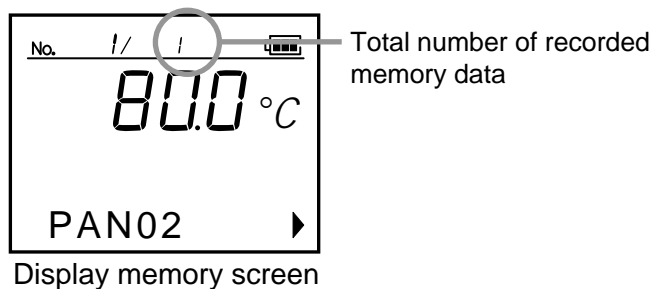

## 5.3 Retrieving Recorded Data

Measured data is recorded in the memory in the order of arrival. The following two types of retrieval are available for checking any tag name and recorded measured-data recorded in the memory. Use either one of them depending on your application.

**Tag filter:** Only measured data with any tag name is retrieved and then displayed.

**Log jump:** Recorded measured-data is displayed by specifying the display memory number.

### 5.3.1 Retrieving only recorded data with specified tag name (Tag Filter)

As measured data is recorded in the order of arrival, there may be a case where no data is recorded for each tag name. It is possible to retrieve and then display only the measured data with the specified tag name by setting this tag filter.

#### ■ Procedures

1. Press the MENU/POWER and SET keys in this order while displaying the measurement screen to display the display memory screen.

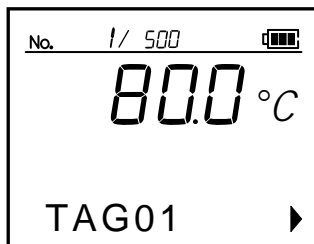

2. Press the ▲ or ▼ key while displaying the display memory screen to display the log name to be retrieved.

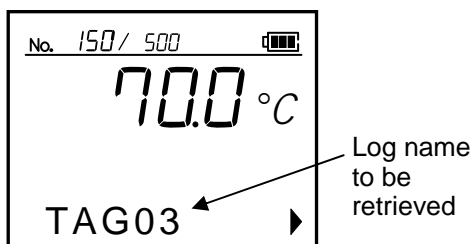

3. Press the MENU/POWER key to display the Tag Filter screen.

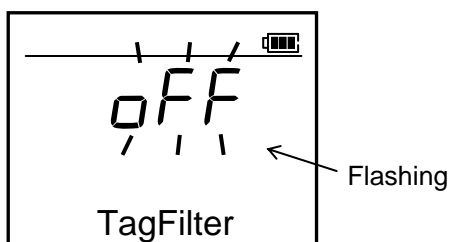

4. Press the ▲ key to change the item to "ON."

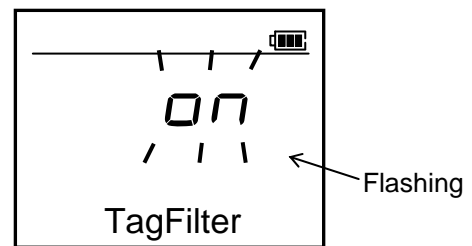

5. Press the SET key to store the new set value. Returns to the display memory screen with the log name to be retrieved.

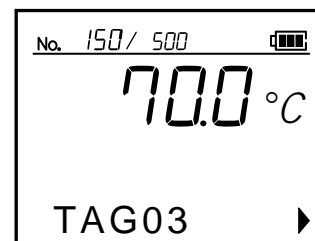

6. Pressing the ▲ or ▼ key displays only the display memory screen with the log name retrieved. To return to the measurement screen, press the SET key twice.

#### How to release the log filter?

Change the log filter setting to "OFF" by pressing the ▼ key and then press the SET key.

### 5.3.2 Retrieving recorded data with specified log registered No. (Log Jump)

It is possible for the DP-700A to record up to 99 logs and for the DP-700B, up to 9999 logs, respectively. For this reason, it is more difficult to select the display memory screen of data to be checked as the number of recording data items increases. It is possible to retrieve and then display any data with specified display memory number by setting this Log Jump.

#### ■ Procedures

1. Press the MENU/POWER key and SET key in this order while displaying the measurement screen to display the display memory screen.

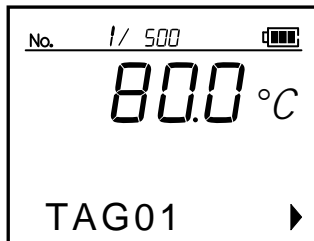

2. Press the MENU/POWER key twice to display the Log Jump screen.

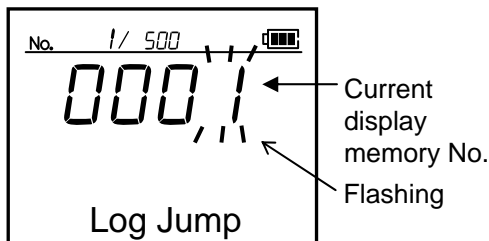

3. Press the ▲ key, ▼ key, or the shift key (<, >) to display the log name to be retrieved.

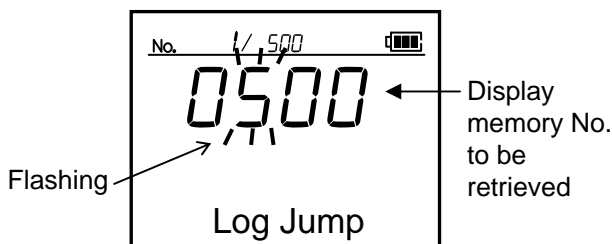

4. Press the SET key.

Displays the screen with the display memory number specified. To return to the measurement screen, press the SET key twice.

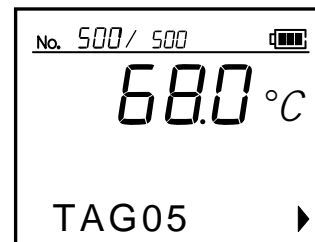

#### 📖 How to cancel the log jump?

Press the ESC key.

The display returns to the Logging (Fn3) screen.

## 5.4 Deleting Recorded Data

The following two types of procedure are available for deleting measured data recorded in the memory.

**Deleted?:** Deletes only one recorded data item.

**All data deleted?:** Deleted all recorded data items.

### 5.4.1 Deleting only one recorded data item (Delete?)

Can delete only one recorded data item selected. If the procedure for this deletion is executed, the display memory number and the total number of recorded data items decrease by one.

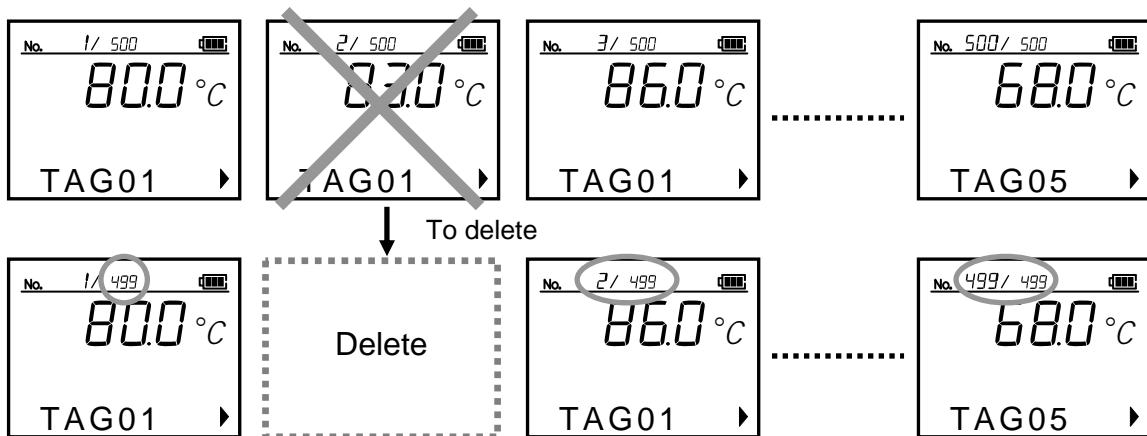

#### ■ Procedures

1. Press the MENU/POWER key and SET key in this order while displaying the measurement screen to display the display memory screen.

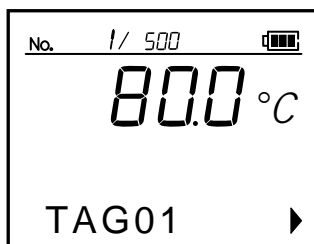

2. Press the ▲ or ▼ key while displaying the display memory screen to display the screen to be deleted.

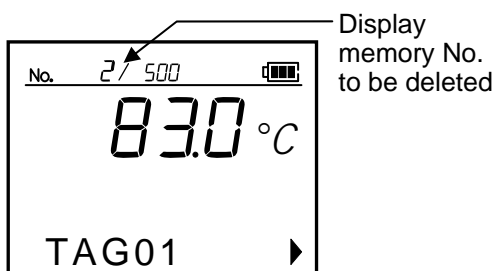

3. Press the MENU/POWER key three times to display the delete check screen.

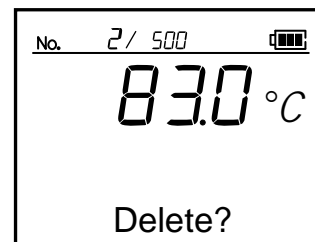

#### How to cancel "Delete?"

Press the ESC key.

The display returns to the display memory screen.

4. Pressing the SET key executes the procedure for this deletion. The display returns to the display memory screen. To return to the measurement screen, press the SET key twice.

### 5.4.2 Deleting all recorded data items (All Clear?)

Can delete all recorded data items recorded.

#### ■ Procedures

1. Press the MENU/POWER and SET keys in this order while displaying the measurement screen to display the display memory screen.

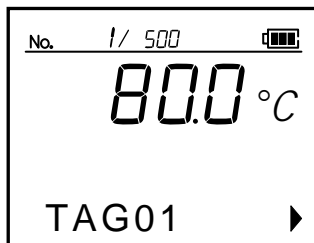

2. Press the MENU/POWER key four times to display the All Clear check screen.

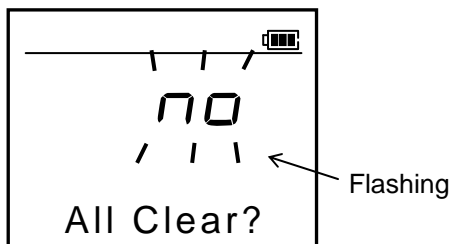

3. Press the ▲ key to change the item to "YES."

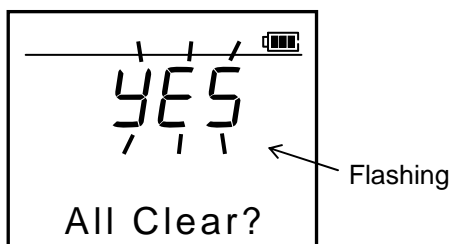

#### How to cancel "YES"?

Press the ESC key.  
The display returns to the display memory screen.



To return to the measurement screen, press the ESC key three times.

4. Pressing the SET key executes the procedure for this deletion (All Clear).

The following progress check screen is displayed during the execution of this deletion.

**Do not press the key until this screen automatically disappears.**

Returns to the measurement screen after the procedure for this deletion is finished.



**No deletion is suspended even if the ESC key is pressed while the procedure for this deletion is in progress.**

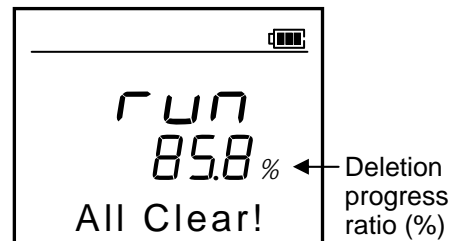

This deletion is finished.

Returns to the measurement screen

## 5.5 Defragmenting Recorded Data

If measured data recording and deleting operation are repeated, the recording memory capacity may become insufficient. However, it becomes possible to efficiently secure the recordable area by rearranging recorded data in the memory and defragmenting the memory area.

### ■ Procedures

1. Press the MENU/POWER and SET keys in this order while displaying the measurement screen to display the display memory screen.

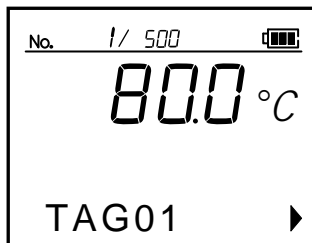

2. Press the MENU/POWER key five times to display the defrag check screen.

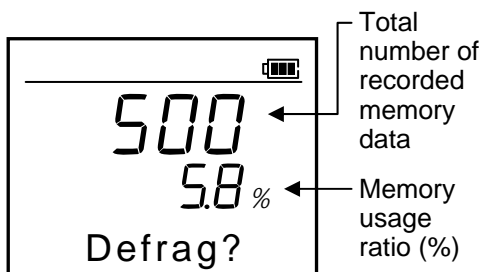

#### How to cancel the procedure for this defragmentation?

Press the ESC key.  
The display returns to the display memory screen. To return to the measurement screen, press the ESC key twice.

3. Pressing the SET key executes the procedure for this defragmentation.

The following progress check screen is displayed while defragmentation is being executed. Time required for this defragmentation differs depending of the memory area being used.

**Do not press the key until this screen automatically disappears.**

Returns to the display memory screen after the procedure for this defragmentation is finished.

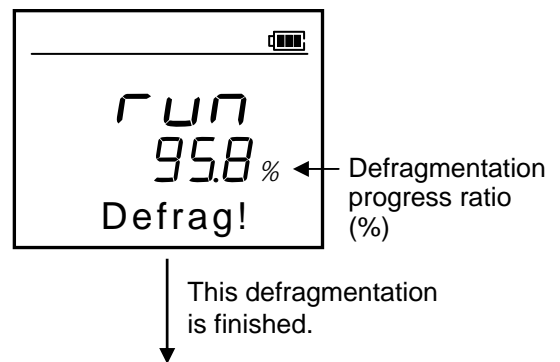

Returns to the display memory screen

 To return to the measurement screen, press the ESC key twice.

 The defragmentation is possible even during automatic recording. In addition, automatic recording continues after the defragmentation is finished.

# 6. PEAK HOLD/BOTTOM HOLD

The peak hold/bottom hold function is used to store (hold) the maximum (peak) and minimum (bottom) measured temperature. Each of these values is updated when the measured temperature becomes more (or less) than the value now being held.

However, if the following operation is performed, the value now being held is reset and as a result the measured temperature just when reset becomes the peak hold or bottom hold value.

- When replaced the battery.
- When changed sensor type, display unit or decimal point position
- When reset (peak/bottom) by the key operation

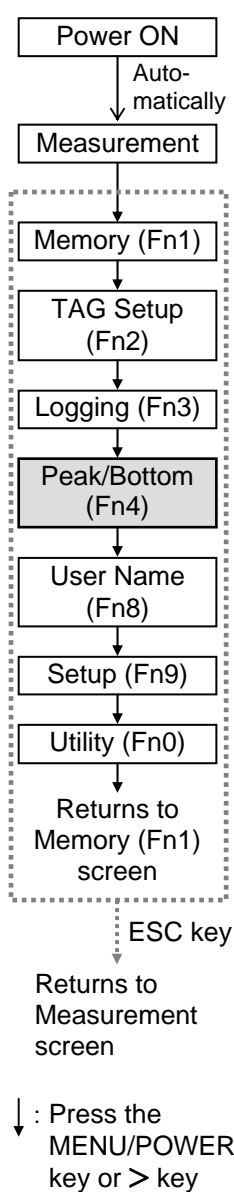

## ■ To display the peak hold value/bottom hold value

1. Press the SET key at Peak/Bottom (Fn4) screen. The display goes to Peak hold value screen.
2. Press the SET key. The display goes to Bottom hold value screen.
3. Press the SET key. The display returns to Peak hold value screen.

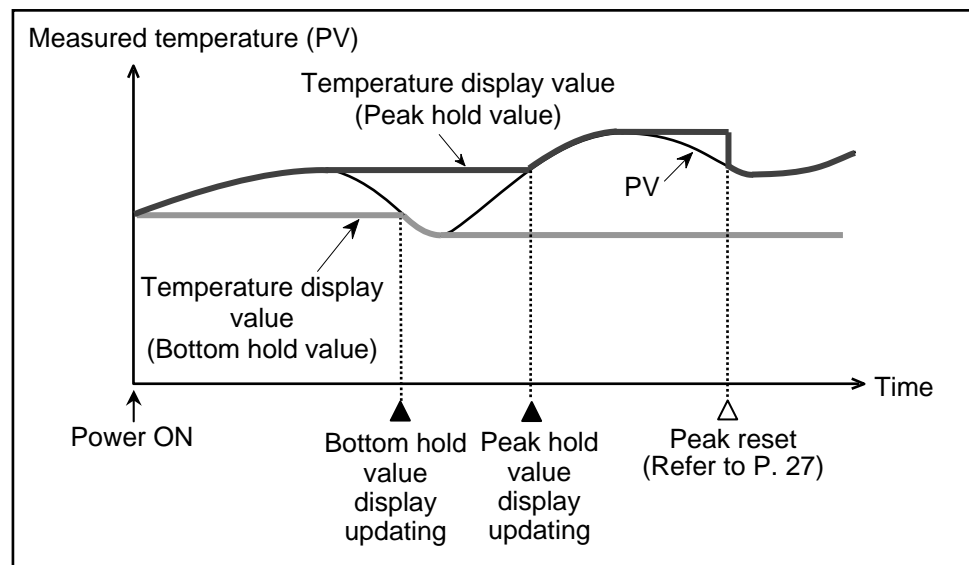
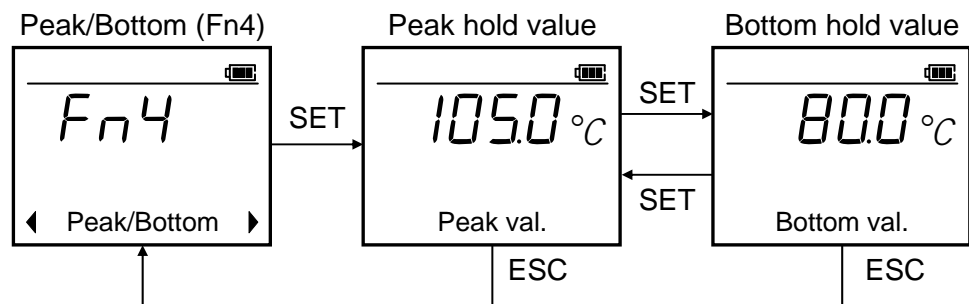



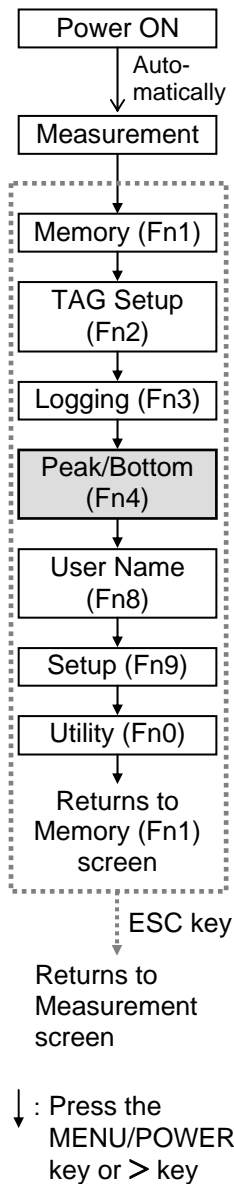

### ■ To reset the peak hold value

1. Press the MENU/POWER key at Peak hold value screen.
2. "Peak rst?" is displayed in the message column.  
To execute reset: Press the SET key.  
To cancel reset: Press the ESC key.
3. The display returns to Peak hold value screen.

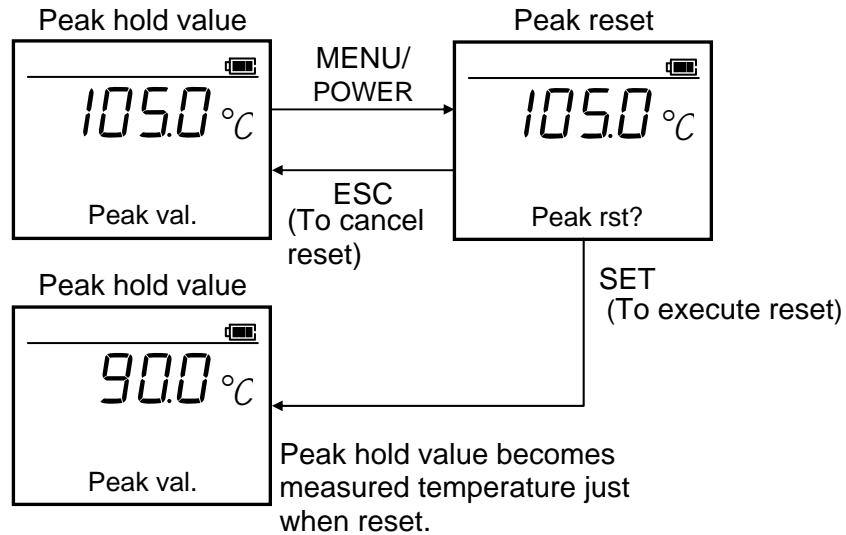

### ■ To reset the bottom hold value

1. Press the MENU/POWER key at Bottom hold value screen.
2. "Bottom rst?" is displayed in the message column.  
To execute reset: Press the SET key.  
To cancel reset: Press the ESC key.
3. The display returns to Bottom hold value screen.

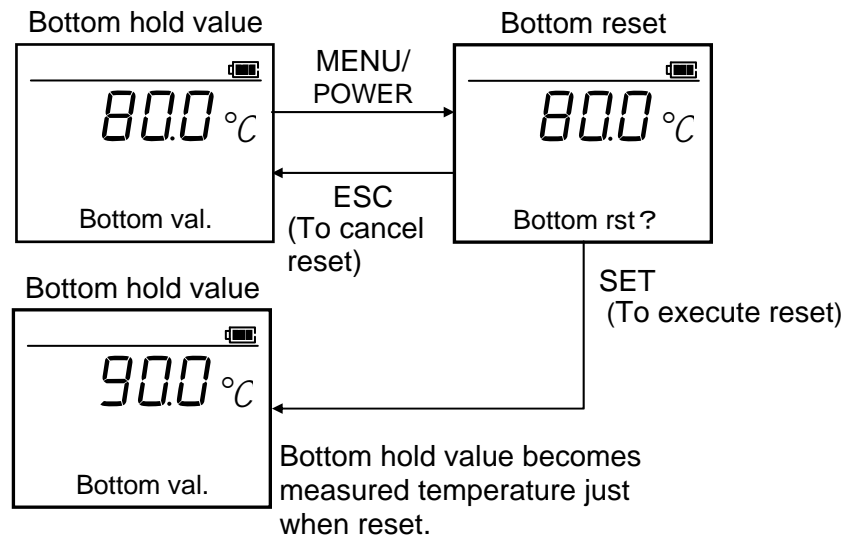

# 7. REGISTERING USER NAMES [ONLY FOR DP-700B]

This chapter describes the procedure for registering user name.

Any user name can be registered (11 characters max.) for each user number. In addition, it is possible to set the user by selecting the user number. The user thus set is retained until the power is turned off. The registered user name is displayed when the power is turned on.

## Screen configurations of User Name (Fn8) menu:

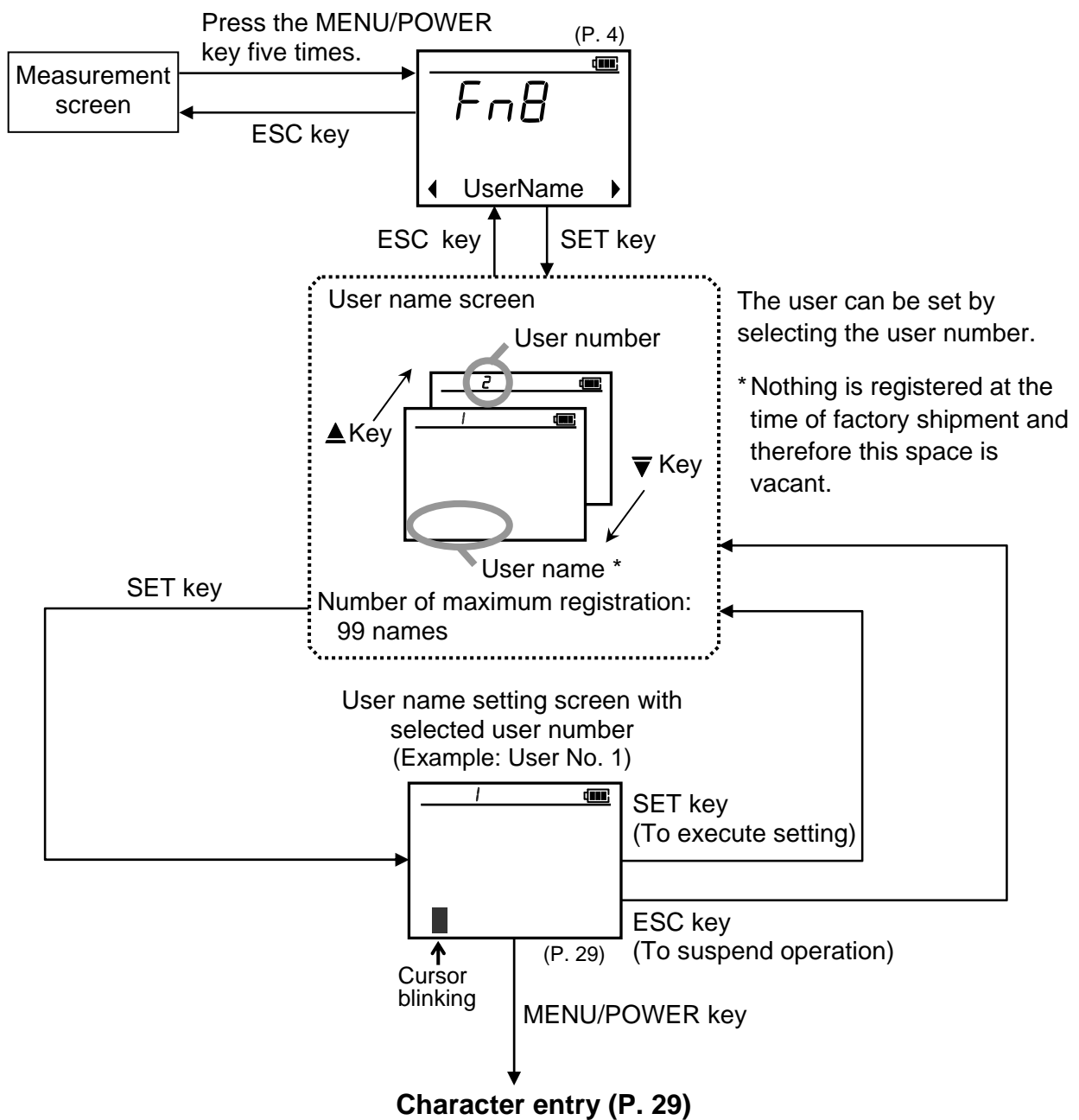

■ Character entry screen

**Example: When the user name screen of user No. 1 is selected.**

User name setting screen

Character selecting screen

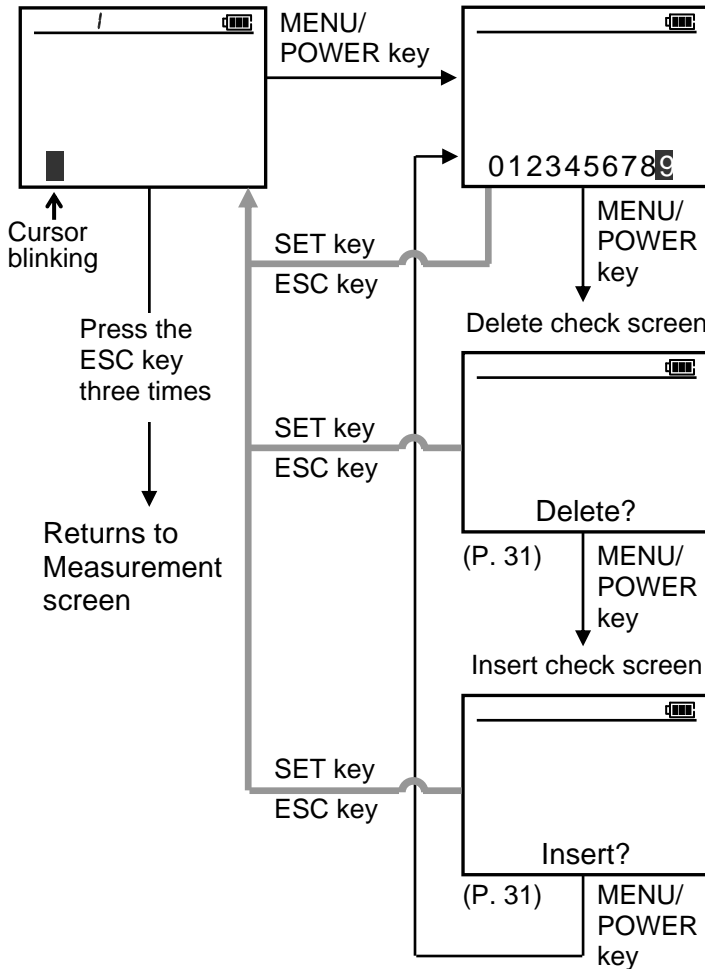

A list of characters including the currently selected character (cursor blinking) is displayed in the message column.

**Select the list of characters by the ▼ or ▲ key and then select the desired character by the < or > key.**

**SET key: To execute selection**  
**ESC key: To suspended operation**

Screen used to check whether or not the currently selected character (cursor blinking) is deleted.

**SET key: To execute deletion**  
**ESC key: To suspend operation**

Screen used to check whether to insert space for entering a character in the position displayed with the currently selected character (cursor blinking).

**SET key: To execute insertion**  
**ESC key: To suspend operation**

Characters list

Numerals	0123456789
Alphabets	ABCDEFGHI JKLMNOPQR STUVWXYZ abcdefghi jklmnopqr stuvwxyz

Symbols	@!#\$%&` +-.;=^_ { } [ ] ( )
---------	------------------------------------

No spaces (no characters) can be used.

Select the list of characters by the ▲ or ▼ key.

■ Procedures

**Example: Registers the user name “RKC” to user No. 1.**

1. Press the SET key at User Name menu (Fn8) screen. The display goes to user name screen of user No. 1.

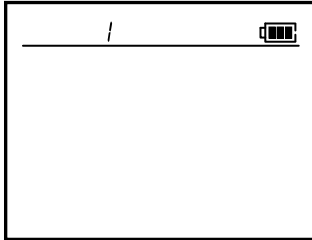

2. Press the SET key.  
The cursor is displayed

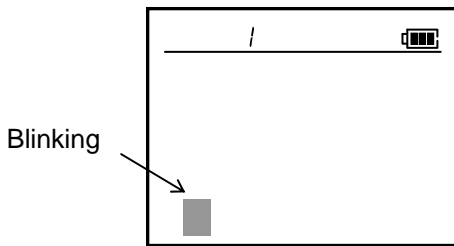

3. Press the MENU/POWER key.  
The list of characters is displayed in the message column.

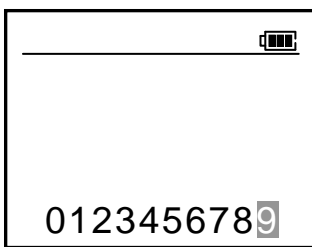

4. Press the ▼ key twice.  
The list of characters including “R” is displayed.



5. Press the SET key to store “R.”  
The screen returns to the user name screen of user No. 1 and the cursor moves to the right.

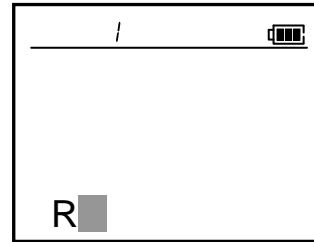

6. Press the MENU/POWER key.  
The list of characters is displayed in the message column.



7. Press the < key to move the cursor to the position displayed with “K.”

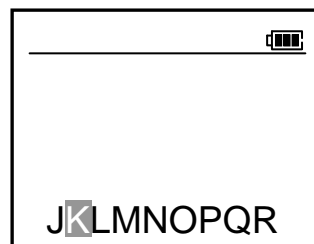

8. Press the SET key to store “K.”  
The screen returns to the user name screen of user No. 1 and the cursor moves to the right.



9. Press the MENU/POWER key.

The list of characters is displayed in the message column.



10. Press the ▲ key.

The list of characters including “C” is displayed.

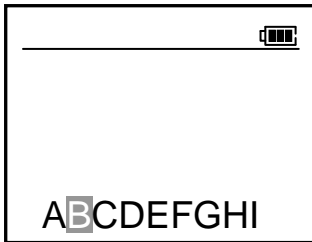

11. Press the > key to move the cursor to the position displayed with “C.”

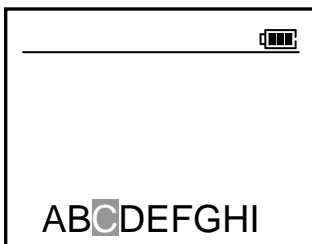

12. Press the SET key to store “C.”

The screen returns to the user name screen of user No. 1 and the cursor moves to the right.

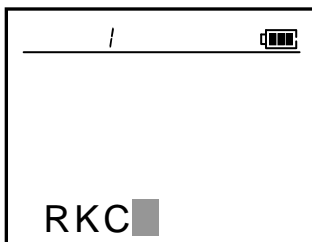

13. Press the SET key to store the “RKC.”  
The cursor disappears. The name setting is finished.

To return to the measurement screen, press the ESC key twice.



 **How to change the character without displaying the list of characters?**

1. Move the cursor to the position displayed with the character to be revised by using the < or > key.
2. Display the character to be revised by using the ▲ or ▼ key.

 **How to delete one character?**

1. Move the cursor to the position displayed with the character to be deleted using the < or > key.
2. Press the MENU/POWER key twice to display the screen for checking the deletion.
3. Press the SET key to delete the character where the cursor blinked.

 **How to insert space for entering a character in any position?**

1. Move the cursor to the position where a character needs to be entered using the < or > key.
2. Press the MENU/POWER key three times to display the screen for checking the entry.
3. Press the SET key to insert space for entering the character before the character position where the cursor blinks.

# 8. INITIAL SETTING

This chapter introduces each function which can be set according to the customer applications. **For items that are not necessary to be changed, use the same setting values as the factory set values.**

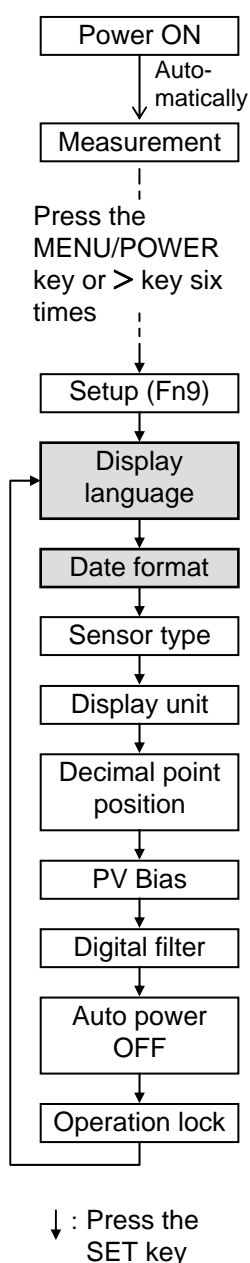

## ■ To select the display language (English/Japanese)

Select the language (English/Japanese) which needs to be displayed on the screen.

1. Press the ▲ or ▼ key to select the “English or Japanese.”

Data range: English or Japanese  
 Factory set value: English

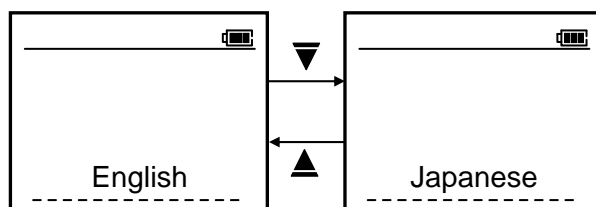

2. Press the SET key to store the new set value.

To return to the measurement screen, press the ESC key twice.

## ■ To select the date format

Select the date format.

1. Press the ▲ or ▼ key to select the “Date format.”

Data range: month/day or day/month  
 Factory set value: month/day

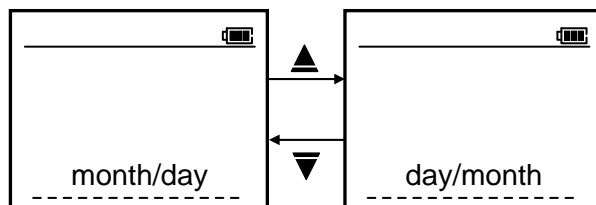

2. Press the SET key to store the new set value.

To return to the measurement screen, press the ESC key twice.

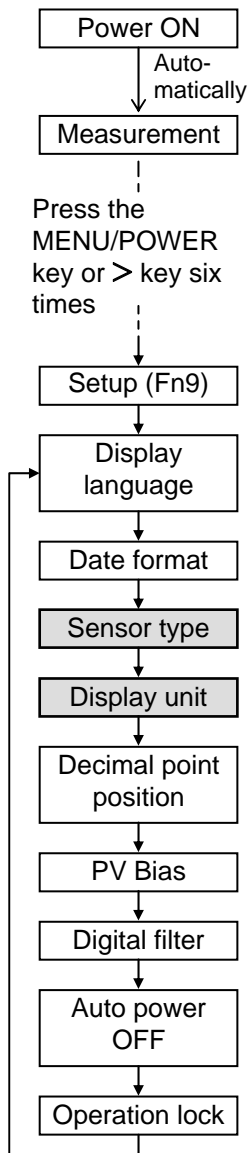

### ■ To select the sensor type

Select the sensor type used for measurement.

1. Press the ▲ or ▼ key to select the “Sensor type.”

Data range: TC-K: Thermocouple K  
 TC-J: Thermocouple J  
 Pt100: RTD Pt100  
 TC-T: Thermocouple T  
 Factory set value: TC-K (Thermocouple K)

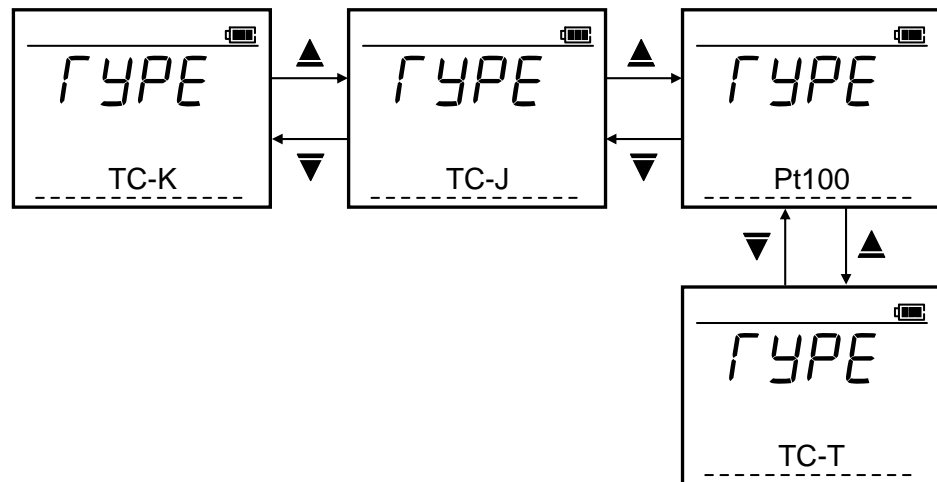

2. Press the SET key to store the new set value.

To return to the measurement screen, press the ESC key twice.

### ■ To select the display unit (°C/°F)

Select the display unit of measured temperature.

1. Press the ▲ or ▼ key to select the “Display unit.”

Data range: °C or °F  
 Factory set value: °C

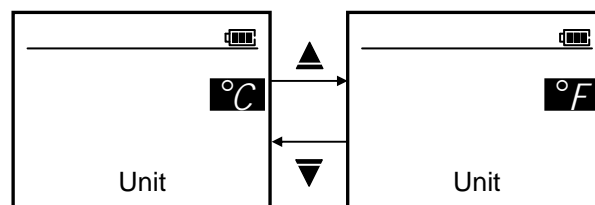

2. Press the SET key to store the new set value.

To return to the measurement screen, press the ESC key twice.

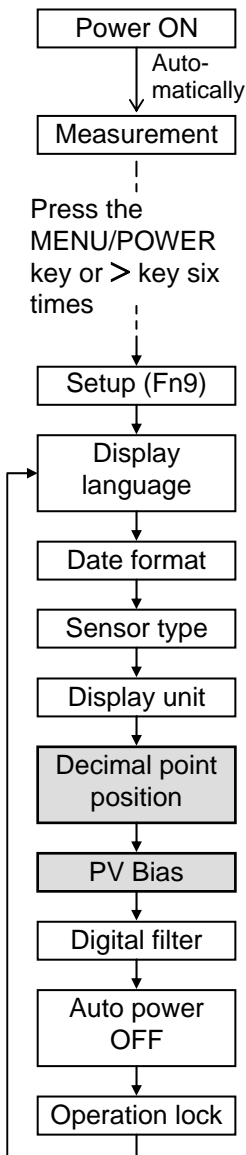

↓ : Press the SET key

**■ To select the decimal point position**

Select the decimal point position of input range.

1. Press the ▲ or ▼ key to select the “Decimal point position.”

- Data range:           0.1: One decimal place
- 1: No decimal place
- Factory set value: 0.1 (One decimal place)

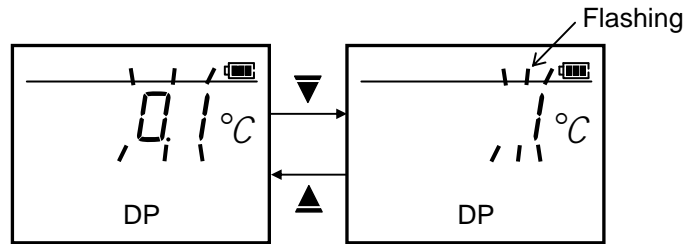

2. Press the SET key to store the new set value.

To return to the measurement screen, press the ESC key twice.

**■ To correct the temperature display value (PV Bias)**

Set the bias (correction value) added to the measured temperature for sensor correction. The PV bias is used to compensate the individual variations of the sensors or correct the difference between the measured temperatures of other instruments.

1. Press the < or > key to move the flashing digit.  
 2. Press the ▲ or ▼ key to set the “Correction value.”

- Data range:           -99.9 to +99.9 °C (°F)
- Factory set value: 0.0

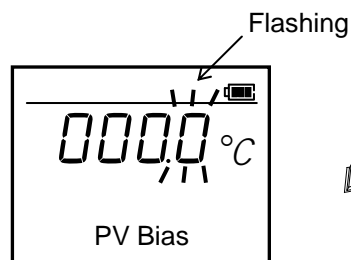

To return to the measurement screen, press the ESC key twice.

3. Press the SET key to store the new set value.

Example:

If PV bias correction value of 1.0 °C is added to the measured temperature. When the measured temperature is 99.0 °C, temperature display will become 100.0 °C (= 99.0 °C + 1.0 °C).

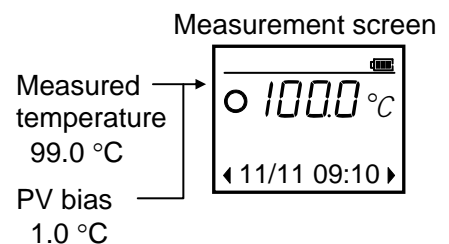



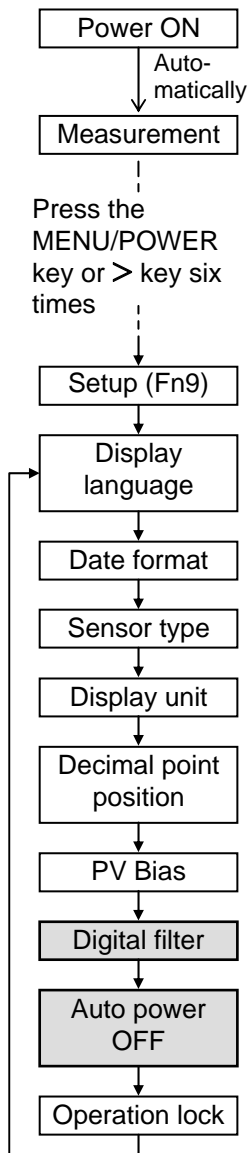

↓ : Press the SET key

### ■ To lessen the fluctuation of a display value caused by noise (Digital Filter)

Set the time of the first-order lag filter eliminate noise against the measured input. The digital filter is used to lessen the fluctuation of a display value caused by noise.

1. Press the < or > key to move the flashing digit.
2. Press the ▲ or ▼ key to set the “filter time.”

Data range: OFF (Unused), 1 to 100 seconds

Factory set value: OFF

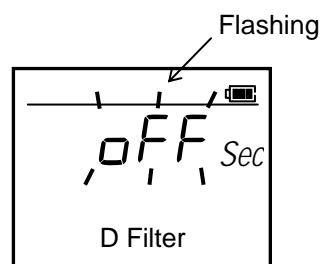

3. Press the SET key to store the new set value.

To return to the measurement screen, press the ESC key twice.

### ■ Saving battery consumption (Auto Power OFF)

Set the time until the power is automatically turned off after no key operation is performed.

1. Press the < or > key to move the flashing digit.
2. Press the ▲ or ▼ key to set the “Auto power OFF time.”

Data range: OFF (Unused), 1 to 60 minutes

Factory set value: 3

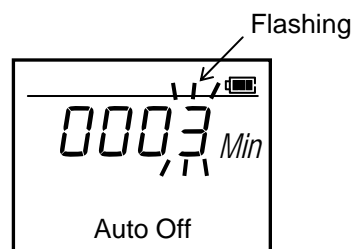

3. Press the SET key to store the new set value.

To return to the measurement screen, press the ESC key twice.

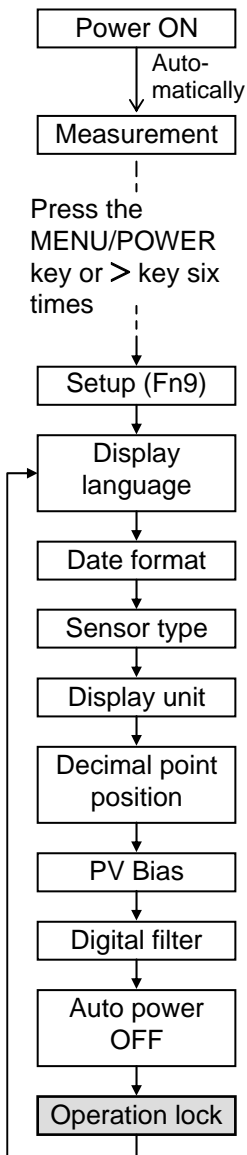

↓ : Press the SET key

■ Locking/Unlocking setting operation (Operation Lock)

Select setting disabled (locked)/setting enabled (unlocked) for each item. Misoperation during usage can be prevented.

1. Press the < or > key to move the flashing digit.
2. Press the ▲ or ▼ key to set the “Disabled (locked)/setting enabled (unlocked).”

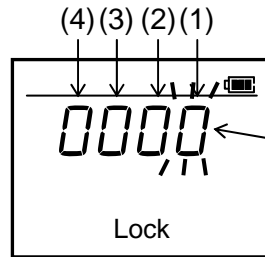

Factory set value: 0000 (unlocked)

To return to the measurement screen, press the ESC key twice.

Setting items		Data range
(1)	Calendar timer (date and time) setting	0: Setting enabled (unlocked). 1: Disabled (locked)
(2)	Setting items of Logging (Fn3), User Name (Fn8) and Setup (Fn9) menus.	
(3)	Setting items of TAG Setup menu (Fn2)	
(4)	Deletion of record data (1 or all records data)	

3. Press the SET key to store the new set value.

# 9. MANAGING DATA BY PC [ONLY FOR DP-700B]

For the DP-700B, it is possible to manage recorded (logging) temperature data, tag and initial set data stored in the memory by a personal computer with the DP-700B connected to the USB port of the computer.

This chapter describes procedures for connecting the DP-700B to a personal computer and also for managing stored data.

## <System Requirements for a USB Connection>

Personal Computer: DOS/V PC and PC98-NX Series loaded with USB port (USB 2.0/1.1)

OS: Windows XP (32-bit and 64-bit versions),  
Windows Vista (32-bit and 64-bit versions),  
Windows 7 (32-bit and 64-bit versions)

## 9.1 Connecting PC to DP-700B

As the DP-700B is operated by the OS standard driver, it can be used only by connecting it to a PC.

1. The DP-700B is connected to the USB port of a PC using the USB cable attached.  
The DP-700B can be connected with the power turned on or off. \*
2. The message “ \*\*\*USB\*\*\* ” is displayed on the bottom of the DP-700B screen to disable key operation. In addition, data logging stops when being logged.



If the DP-700B is used for the first time, the OS standard driver is automatically installed. Start the windows system with the DP-700B unconnected to log on as a user account with administrator privilege. First start the system, and then connect the PC to the DP-700B.

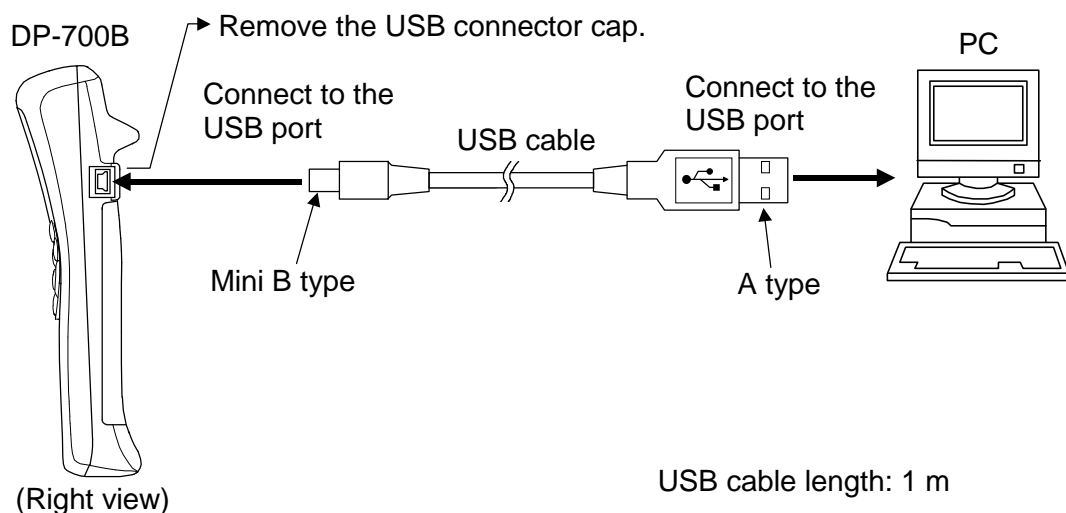

- \* The DP-700B is compatible with the USB bus power. The power is supplied from the USB port on the PC side via the USB cable when connected with USB. It is possible to manage data by connecting USB even with the DP-700B power turned off.

3. Open “Devices and Printers” of Windows to newly add the “USB mass storage device” icon.

## 9.2 Storing Data

Open “Devices and Printers” of Windows to double click the “USB mass storage device” icon. Thus, three CSV files in the DP-700B memory area displayed.

- LOG\_□.CSV: Recorded (logging) temperature data
- TAG\_□.CSV: Tag setting data
- SETUP\_□.CSV: Initial setting data

 The LOG\_□.CSV, TAG\_□.CSV and SETUP\_□.CSV files are created when the DP-700B is connected to USB.

As a file name of each file created, characters of identifying each entity (DP-700B) are entered in □. Thus, two or more DP-700B files are identified.

 If no temperature data is stored within the DP-700B memory, the LOG\_□.CSV file is not displayed.

### ■ LOG\_□.CSV (Recorded temperature data)

Recorded (logging) temperature data. Read only file. It can be opened and referred to by table calculation software such as Excel. In addition, it can be copied it stored at a location other than the DP-700B using a new name.

#### CAUTION

Deleting the LOG\_□.CSV file also clears all recorded temperature data within the DP-700B memory. Take care not to delete necessary recorded temperature data.

 If no temperature data is stored within the DP-700B memory, the LOG\_□.CSV file is not displayed.

**Contents of file:** Memory No., Date, Time, Temperature, Tag No., User No.

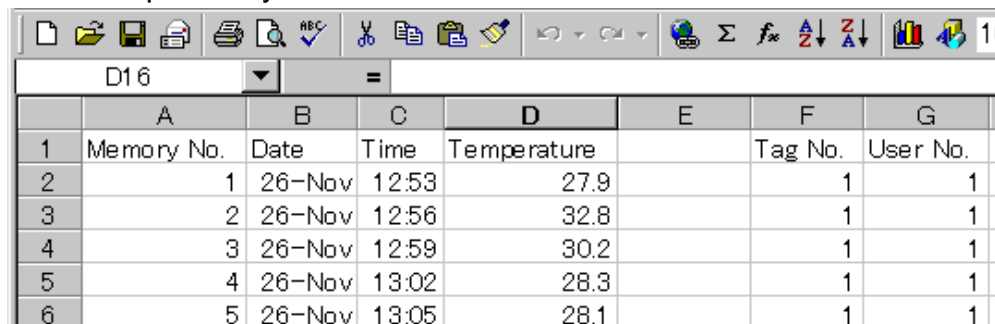

< When opened by Excel >



	A	B	C	D	E	F	G
1	Memory No.	Date	Time	Temperature		Tag No.	User No.
2	1	26-Nov	12:53	27.9		1	1
3	2	26-Nov	12:56	32.8		1	1
4	3	26-Nov	12:59	30.2		1	1
5	4	26-Nov	13:02	28.3		1	1
6	5	26-Nov	13:05	28.1		1	1

### ■ TAG\_□.CSV (Tag setting data)

DP-700B tag setting data. Writable/readable file. If it is opened by table calculation software such as Excel and then is edited and overwrite-stored, the setting can be reflected to the DP-700B.

 Writes is inhibited if setting items in the TAG Setup menu (Fn2) is set to “Not be set (locked).”  Refer to ■ **Locking/Unlocking setting operation (P. 36).**

#### Contents of file:

Name	Data range	Factory set value
Tag No.	1 to 99	—
Tag Name	11 characters Refer to <b>List of usable characters (P. 41)</b>	TAG01 to 99
Judgment point of high temperature	Same as temperature input range	0.0 °C or 32.0 °F
Judgment point of low temperature	Same as temperature input range	0.0 °C or 32.0 °F

< When opened by Excel >

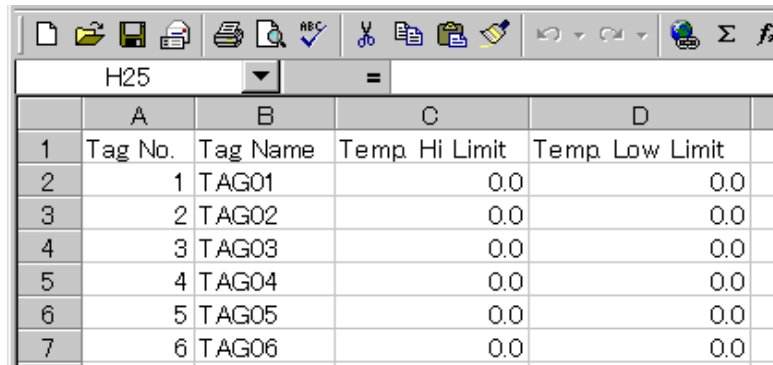

	A	B	C	D
1	Tag No.	Tag Name	Temp Hi Limit	Temp Low Limit
2	1	TAG01	0.0	0.0
3	2	TAG02	0.0	0.0
4	3	TAG03	0.0	0.0
5	4	TAG04	0.0	0.0
6	5	TAG05	0.0	0.0
7	6	TAG06	0.0	0.0

■ **SETUP\_□.CSV (Initial setting data)**

DP-700B initializing setting data. Writable/readable file. If it is opened by table calculation software such as Excel and then is edited and overwrite-stored, the setting can be reflected to the DP-700B.

 Writes is inhibited if setting items in the Logging (Fn3), User Name (Fn8) and Setup (Fn9) menus are set to “Not be set (locked).”

 Refer to ■ **Locking/Unlocking setting operation (P. 36).**

**Contents of file:**

Name	Command	Data range	Factory set value
User name	User=	11 characters Refer to <b>List of usable characters (P. 41)</b>	Blank (No name)
Display language	Language=	0: Japanese 1: English	1
Date format	Date_format=	0: Month/Day 1: Day/Month	0
Sensor type	Input=	0: Thermocouple K 1: Thermocouple J 2: RTD (Pt100) 3: Thermocouple T	0
Display unit	Unit=	0: °C 1: °F	0
Decimal point position	TempDP=	0: No decimal place 1: One decimal place	1
PV bias	TBias=	-99.9 to +99.9 °C (°F)	0.0
Digital filter	TFilter=	0 to 100 seconds (0: OFF)	0
Auto power OFF	AutoOFF=	0 to 60 minutes (0: OFF)	3
Interval time	Interval=	0 to 3600 seconds (0: OFF)	0

< When opened by Excel >

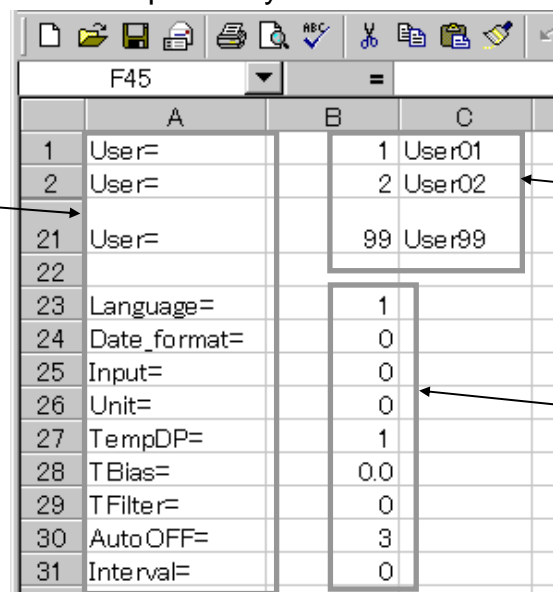

Command →

User No., User name →

Setting data →

### ● List of usable characters

Numeral	0123456789
Alphabets	ABCDEFGHI JKLMNOPQR STUVWXYZ abcdefghi jklmnopqr stuvwxyz
Symbols	@!#\$%&'` +-.;=^_ ([]{}



Spaces cannot be used.

### ■ Storing data in hard disk of PC

Copy data to the hard disk of the PC using Windows Explorer.

## 9.3 Disconnecting DP-700B from PC

Disconnect the DP-700B from the PC after the PC power is turned off or according to the following steps.





**Do not disconnect the DP-700B from the PC when the file is opened or while the file is being stored. Malfunction may result.**



The DP-700B can be disconnected with the power turned on or off.



The disconnecting procedure is described in “Windows 7.” Icons and windows displayed differ depending on OS used. For details, refer to the manual for “Windows.”

1. Check that the file is not opened or it is being stored. Close when the file is opened.
2. Click “Show hidden icons”  in the taskbar. The notification area is displayed.
3. Click “Safely Remove Hardware”  in the notification area.
4. Click “Eject USB mass storage devices” in the displayed menu.



**The displayed contents depend on the number of USB devices connected to your computer. Carefully click the icon not to select a wrong device.**

5. The “Safely Remove Hardware” icon  moves to the notification area. When you see the message “Safe to remove hardware - The USB mass storage device can now be safely removed from the computer,” remove the device from your computer.
6. Disconnect the DP-700B from the PC.

# 10. APPENDIX

## 10.1 Replace the Battery

If  (Battery service life is going to expire) is displayed, immediately replace the battery.

Replace battery: Type LR6 (based on IEC and JIS) alkaline battery, One battery

Battery life: Can be operated for 400 hours continuously (Around the ambient temperature 23 °C). However, the battery service life varies depending on the operating condition and environment. Therefore, the above service life period is only for reference.



**If the battery is replaced, the instrument is reset-started. Therefore, there are some data items to be initialized. In addition, for the DP-700A all recorded data items are deleted. The state of each data when the battery is replaced (when reset-started) is shown in the following.**

### ● Monitor items

Name	DP-700A	DP-700B
Peek hold	Reset (Peak hold value becomes measured temperature just when reset.)	
Bottom hold	Reset (Bottom hold value becomes measured temperature just when reset.)	
Recorded (logging) data	All recorded data clear	Hold

### ● Setting items

Name	DP-700A	DP-700B
Tag Filter	Initialize (OFF)	
Tag Name	Hold	
Judgment point of high temperature	Hold	
Judgment point of low temperature	Hold	
Interval time	Hold	
User No. selection	—	Initialize (User No. 1)
User name	—	Hold
Display language	Hold	
Date format	Hold	
Sensor type	Hold	
Display unit	Hold	
Decimal point position	Hold	
PV bias	Hold	
Digital filter	Hold	
Auto power OFF	Hold	
Operation lock	Calendar timer setting: Can be set (Unlock) Other setting items: Hold	
Year	Initialize (0)	
Date	Initialize (01/01)	
Time	Initialize (00:00)	



## ■ Procedures

1. Press the MENU/POWER key for more than two seconds to turn off the DP-700 power.
2. Loosen the battery cover.

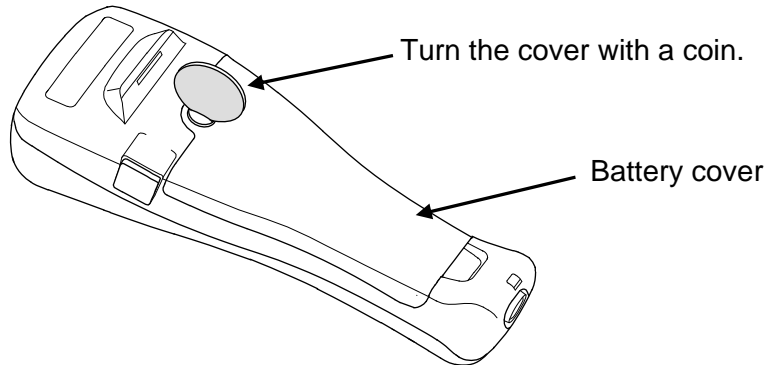

3. Remove the battery cover.
4. Remove the old battery. Load a new battery without mistaking its polarity.

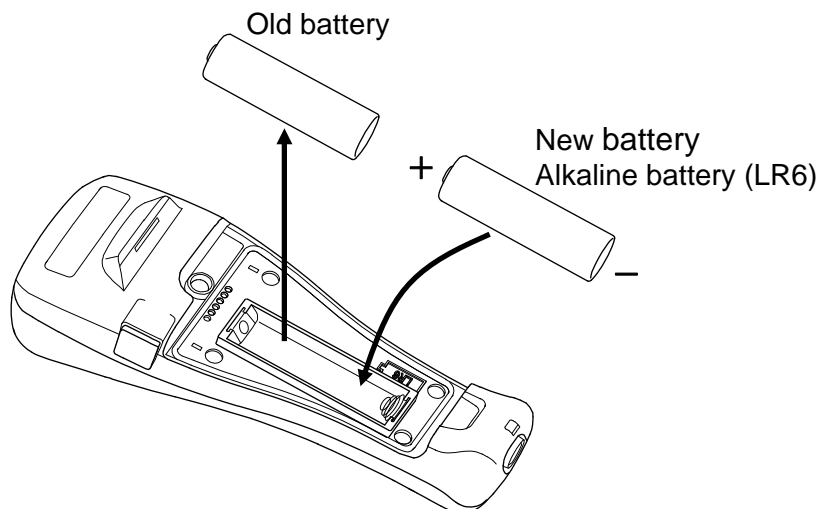

5. Then, firmly tighten the battery cover.



**Insufficient tightening cannot assure the effect of water resistance (DP-700A: Equal to IP67, DP-700B: Equal to IP54).**



After the battery is loaded, the instrument is ready to be reset-started.

The function menu “Utility (Fn0)” for setting the dominical year is displayed on the LCD screen. **If no dominical year is set, no calendar function can be used. Always set the year if the calendar function is used.**



Year setting screen

Pressing the ESC key twice can display the measurement screen.

## 10.2 Cleaning



**Turn off the power supply before cleaning the instrument.**

Moisten a soft cloth with a diluted neutral detergent, completely wring the cloth, then wipe the instrument with cloth. Do not use a volatile solvent such as paint thinner to clean the instrument. Deformation or discoloration will occur.

The DP-700A can be washed in flowing water as it has water and dust resistant characteristics equal to IP67.

However, the DP-700B (Water/dust resistance equal to IP54) cannot be washed in flowing water.

## 10.3 Troubleshooting

This section describes probable causes and treatment procedures if any abnormality occurs in the instrument. For any inquiries, please contact RKC sales office or the agent, to confirm the specifications of the product.



**Prior to replacing the sensor, always turn off the power.**

### 10.3.1 Error displays

Displays and description of errors are described in the following table:

Display	Description	Solution
	Service life is going to expire.	Replace the new battery. Refer to <b>10.1 Replace the Battery (P. 42)</b> .
	Service life has expired.	
	Burnout The sensor is broken, shorted or imperfectly connected.	Check sensor and sensor connection.
	Overscale Measured temperature is above the 5 % of measuring range high limit value or display range limit high (9999).	Check input type, input range, sensor and sensor connection.
	Underscale Measured temperature is below the 5 % of measuring range low limit value or display range limit low (-1999).	

Continued on the next page.

Continued from the previous page.

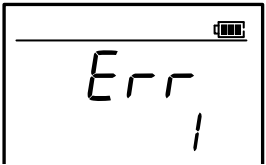
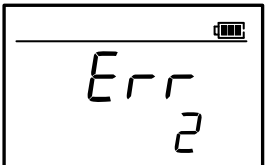
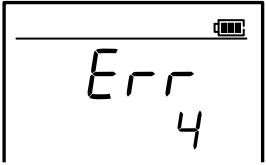
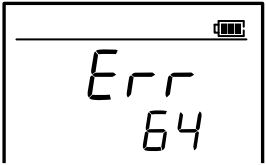
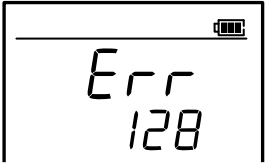
Display	Description	Solution
 <p>(Err 1)</p>	Adjusted data error <ul style="list-style-type: none"> <li>Adjusted data range is abnormal.</li> </ul>	First remove the battery, and then load it again after a lapse of a few seconds.  If not normally operated with the battery re-loaded, please contact RKC sales office or the agent.
 <p>(Err 2)</p>	EEPROM error <ul style="list-style-type: none"> <li>Response signal from EEPROM is abnormal.</li> <li>Data write failure</li> </ul>	
 <p>(Err 4)</p>	A/D conversion error <ul style="list-style-type: none"> <li>Response signal from A/D converter is abnormal.</li> <li>A/D conversion count value is out of the specified range.</li> </ul>	
 <p>(Err 64)</p>	Stack overflow <ul style="list-style-type: none"> <li>Stack point overflows</li> </ul>	
 <p>(Err 128)</p>	Watchdog timer error <ul style="list-style-type: none"> <li>The part of an internal task stops the action.</li> </ul>	



If two or more self-diagnostic errors occur (Err 1, Err 2, Err 4, Err 64 and Err 128), the value obtained by adding the error number to the Err display is displayed.

### 10.3.2 Problem and solution

Problem, possible cause and solution of trouble described in the following table:

Problem	Possible cause	Solution
No power is turned on. (No display appears)	No battery is loaded.	Load a battery. Refer to <b>2.1 Loading Battery (P. 5)</b> .
	The battery with less service life is used.	Replace the new battery. Refer to <b>10.1 Replace the Battery (P. 42)</b> .
Measured temperature display is abnormal	The battery with less service life is used.	Replace the new battery. Refer to <b>10.1 Replace the Battery (P. 42)</b> .
	Noise source is present near the instrument	Separate the noise source from the instrument.
		Set the digital filter. Refer to <b>■ To lessen the fluctuation of a display value caused by noise (P. 35)</b> .
	Proper sensor is not used	Use the specified sensor.
	Sensor insertion depth is insufficient	Check whether sensor is inserted loosely. If yes, fully insert the sensor.
Sensor insertion position is not appropriate	Insert the sensor at the specified location.	
Measured temperature display value differs from the actual value	PV bias is set	Set the PV bias to "OFF." Refer to <b>■ To correct the temperature display value (P. 34)</b> . However, this is limited only to when the PV bias setting can be changed.
The display does not change No key operation is accepted	CPU overrun	First remove the battery, and then load it again after a lapse of a few seconds.  If not normally operated with the battery re-loaded, please contact RKC sales office or the agent.

## 10.4 Specifications

### ■ Input

<b>Input type:</b>	Universal input
	Thermocouple: K, J, T (JIS-C1602-1995)
	RTD: Pt100 (JIS-C1604-1997)
<b>Measuring range:</b>	Thermocouple K: –200 to +1372 °C (Resolution: 1 °C) –328 to +2501 °F (Resolution: 1 °F) –199.9 to +999.9 °C (Resolution: 0.1 °C) –199.9 to +999.9 °F (Resolution: 0.1 °F)
	Thermocouple J: –200 to +1200 °C (Resolution: 1 °C) –328 to +2192 °F (Resolution: 1 °F) –199.9 to +999.9 °C (Resolution: 0.1 °C) –199.9 to +999.9 °F (Resolution: 0.1 °F)
	Thermocouple T: –50 to +400 °C (–58 to +752 °F) –50.0 to +400.0 °C (–58.0 to +752.0 °F)
	RTD Pt100: –200 to +850 °C (Resolution: 1 °C) –328 to +1562 °F (Resolution: 1 °F) –199.9 to +850.0 °C (Resolution: 0.1 °C) –199.9 to +999.9 °F (Resolution: 0.1 °F)
<b>Sampling cycle:</b>	0.5 seconds
<b>PV bias:</b>	–99.9 to +99.9 °C (°F)
<b>Digital filter:</b>	First order lag digital filter: Time constant: 0 to 100 seconds (0: OFF)
	Moving average: 4 times (fixed)

### ■ Performance

**Display accuracy (At the ambient temperature 23 °C ± 2 °C):**  
± (0.1 % of display value + 1 digit) or ± 0.3 °C (0.6 °F)  
Less than the value whichever is greater

**Cold-junction temperature compensation error:**  
±0.5 °C (Within 5 to 40 °C)  
±1.0 °C (Within –20 to +5 °C and 40 to 50 °C)

**Ambient temperature influence:**  
±0.01% /°C of span (Within 5 to 40 °C)  
±0.02% /°C of span (Within –20 to +5 °C and 40 to 50 °C)

### ■ Display

	Reflective FSTN LCD
<b>Measured temperature:</b>	4-digit
<b>Display memory No.:</b>	4-digit
<b>Total number of recorded data:</b>	4-digit
<b>Message:</b>	68 × 8 dots (11 characters)
<b>Recorded (logging) execution:</b>	Lit during execution, flashing during stop for automatic recording.
<b>Burnout:</b>	Lit when the sensor is disconnected, shorted or imperfectly contacted.
<b>Remaining battery service life:</b>	The remaining battery service life is indicated in three steps.
<b>Temperature unit:</b>	12 × 8 dots (°C/°F)

### ■ Data recording (logging)

<b>Recording method:</b>	Manual logging mode: Can be manually recorded in the memory. Automatic logging mode: Can be automatically recorded (in a set interval) in the memory.
<b>Interval time:</b>	0 (Manual log mode), 1 to 3600 seconds
<b>Recording items:</b>	Measured temperature, Tag name, Date, Time
<b>Recording capacity:</b>	DP-700A: Maximum 99 logs DP-700B: Maximum 9999 logs
<b>Memory backup:</b>	DP-700A: Backed up by SRAM The recorded data may be lost if the battery service life has expired or the battery is replaced. DP-700B: Backed up by non-volatile memory (EEPROM) Number of writing: Approx. 100,000 times Data retaining period: Approx. 10 years Depending on storage and operating conditions

### ■ Simplified Judging Function

The judgment points of high and low temperatures are set. When within the judgment points, “○” is displayed while when out of the judgment point, “×” is displayed.

▲ is displayed, if out of the high judgment point, while ▼, if out of the low judgment point.

### ■ Tag number function

<b>Number of maximum registration:</b>	DP-700A: 5 tags DP-700B: 99 tags
<b>Registration items:</b>	Tag name, judgment points of high and low temperatures
<b>Tag name:</b>	11 characters (Numeral, Alphabets, Symbols)
<b>Memory backup:</b>	Backed up by non-volatile memory (EEPROM) Number of writing: Approx. 100,000 times Data retaining period: Approx. 10 years

### ■ User name function (Only for DP-700B)

<b>Number of maximum registration:</b>	99 names
<b>Number of character:</b>	11 characters (Numerals, Alphabets, Symbols)
<b>Memory backup:</b>	Same as <b>Memory backup of Data recording (logging)</b>

### ■ USB function (Only for DP-700B)

<b>Interface:</b>	Based on USB (Universal Serial Bus) Ver2.0
<b>Communication speed (Theory value):</b>	Full Speed compliant (12 Mbps)
<b>Connector type:</b>	USB series Mini-B
<b>Connection:</b>	The DP-700B is connected to the USB port of a PC using the USB cable attached.
<b>Power supply:</b>	Bus power (The power is supplied from the USB port on the PC side.)
<b>Device class:</b>	Mass Storage Class (Bulk-Only Transport)
<b>Compatible OS:</b>	Windows XP (32-bit and 64-bit versions), Windows Vista (32-bit and 64-bit versions), Windows 7 (32-bit and 64-bit versions)

### ■ Other functions

Peak and bottom hold, Calendar timer, Operation lock, Self-diagnostic

### ■ Power

**Battery:** Type LR6 (based on IEC and JIS) alkaline battery, One battery  
**Battery life:** Approx. 400 hours (Continuous operating time, Around the ambient temperature 23 °C).  
 However, the battery service life varies depending on the operating condition and environment. Therefore, the above service life period is only for reference.  
**Power consumption:** 10 mW (Mean value while operated)

### ■ Standards

**Waterproof and dustproof:** DP-700A: IP67  
 DP-700B: IP54  
**CE marking:** EMC: EN61326-1, Annex A  
**C-Tick:** EN55011

### ■ General specifications

**Memory backup:** Backed up by non-volatile memory (EEPROM)  
 Number of writing: Approx. 100,000 times  
 Data retaining period: Approx. 10 years  
 Depending on storage and operating conditions  
 Backup data: Interval time, Display language,  
 Sensor type, Display unit,  
 Decimal point position,  
 PV bias, Digital filter,  
 Auto power OFF, Operation lock,  
 Date format

**Allowable ambient temperature:**  
 -20 to +50 °C  
 However, in an environment of less than 0 °C, the LCD response speed remarkably decreases.

**Allowable ambient humidity:** 5 to 95 %RH  
 Absolute humidity: MAX.W.C 29.3 g/m<sup>3</sup> dry air at 101.3 kPa

**Dimensions:** 57 (W) × 152 (H) × 46 (D) mm  
**Weight:** Approx. 150 g (Including battery)

# **MEMO**







**RKC INSTRUMENT INC.**

HEADQUARTERS: 16-6, KUGAHARA 5-CHOME, OHTA-KU TOKYO 146-8515 JAPAN

PHONE: 03-3751-9799 (+81 3 3751 9799)

FAX: 03-3751-8585 (+81 3 3751 8585)

E-mail: [info@rkcinst.co.jp](mailto:info@rkcinst.co.jp)

Website: <http://www.rkcinst.com/>