*PROFIBUS Communication
Converter*

COM-JG

[For FB100/FB400/FB900]

Instruction Manual

- SIMATIC® is registered trademarks of SIEMENS AG.
- Modbus is a registered trademark of Schneider Electric.
- Company names and product names used in this manual are the trademarks or registered trademarks of the respective companies.

Thank you for purchasing this RKC product. In order to achieve maximum performance and ensure proper operation of your new instrument, carefully read all the instructions in this manual. Please place the manual in a convenient location for easy reference.

SYMBOLS

WARNING : This mark indicates precautions that must be taken if there is danger of electric shock, fire, etc., which could result in loss of life or injury.

CAUTION : This mark indicates that if these precautions and operating procedures are not taken, damage to the instrument may result.



: This mark indicates that all precautions should be taken for safe usage.



: This mark indicates important information on installation, handling and operating procedures.



: This mark indicates supplemental information on installation, handling and operating procedures.



: This mark indicates where additional information may be located.



WARNING

- An external protection device must be installed if failure of this instrument could result in damage to the instrument, equipment or injury to personnel.
- All wiring must be completed before power is turned on to prevent electric shock, fire or damage to instrument and equipment.
- This instrument must be used in accordance with the specifications to prevent fire or damage to instrument and equipment.
- This instrument is not intended for use in locations subject to flammable or explosive gases.
- Do not touch high-voltage connections such as power supply terminals, etc. to avoid electric shock.
- RKC is not responsible if this instrument is repaired, modified or disassembled by other than factory-approved personnel. Malfunction can occur and warranty is void under these conditions.

CAUTION

- This product is intended for use with industrial machines, test and measuring equipment. (It is not designed for use with medical equipment and nuclear energy.)
- This is a Class A instrument. In a domestic environment, this instrument may cause radio interference, in which case the user may be required to take additional measures.
- This instrument is protected from electric shock by reinforced insulation. Provide reinforced insulation between the wire for the input signal and the wires for instrument power supply, source of power and loads.
- Be sure to provide an appropriate surge control circuit respectively for the following:
 - If input/output or signal lines within the building are longer than 30 meters.
 - If input/output or signal lines leave the building, regardless the length.
- This instrument is designed for installation in an enclosed instrumentation panel. All high-voltage connections such as power supply terminals must be enclosed in the instrumentation panel to avoid electric shock by operating personnel.
- All precautions described in this manual should be taken to avoid damage to the instrument or equipment.
- All wiring must be in accordance with local codes and regulations.
- All wiring must be completed before power is turned on to prevent electric shock, instrument failure, or incorrect action.

The power must be turned off before repairing work for input break and output failure including replacement of sensor, contactor or SSR, and all wiring must be completed before power is turned on again.
- To prevent instrument damage or failure, protect the power line and the input/output lines from high currents with a protection device such as fuse, circuit breaker, etc.
- Prevent metal fragments or lead wire scraps from falling inside instrument case to avoid electric shock, fire or malfunction.
- Tighten each terminal screw to the specified torque found in the manual to avoid electric shock, fire or malfunction.
- For proper operation of this instrument, provide adequate ventilation for heat dispensation.
- Do not connect wires to unused terminals as this will interfere with proper operation of the instrument.
- Turn off the power supply before cleaning the instrument.
- Do not use a volatile solvent such as paint thinner to clean the instrument. Deformation or discoloration will occur. Use a soft, dry cloth to remove stains from the instrument.
- To avoid damage to instrument display, do not rub with an abrasive material or push front panel with a hard object.

NOTICE

- This manual assumes that the reader has a fundamental knowledge of the principles of electricity, process control, computer technology and communications.
- The figures, diagrams and numeric values used in this manual are only for purpose of illustration.
- RKC is not responsible for any damage or injury that is caused as a result of using this instrument, instrument failure or indirect damage.
- RKC is not responsible for any damage and/or injury resulting from the use of instruments made by imitating this instrument.
- Periodic maintenance is required for safe and proper operation of this instrument. Some components have a limited service life, or characteristics that change over time.
- Every effort has been made to ensure accuracy of all information contained herein. RKC makes no warranty expressed or implied, with respect to the accuracy of the information. The information in this manual is subject to change without prior notice.
- No portion of this document may be reprinted, modified, copied, transmitted, digitized, stored, processed or retrieved through any mechanical, electronic, optical or other means without prior written approval from RKC.

CONTENTS

	Page
1. OUTLINE	1
1.1 Product Check	2
1.2 Model Code	2
1.3 Parts Description	3
2. HANDLING PROCEDURES.....	4
3. MOUNTING.....	5
3.1 Mounting Cautions.....	5
3.2 Dimensions.....	6
3.3 DIN Rail Mounting	6
3.4 Panel Mounting.....	7
4. WIRING.....	8
4.1 Wiring Cautions	8
4.2 Terminal Configuration	9
4.3 Connection to PROFIBUS	10
4.4 Connection to the Controllers	12
4.5 Installation of Termination Resistor.....	13
5. SETTING.....	15
5.1 PROFIBUS Address Setting	15
5.2 Controller Communication Speed Setting.....	16
6. PROFIBUS COMMUNICATION	17
6.1 PROFIBUS System Configuration	17
6.2 PROFIBUS Communication Data	18
6.2.1 Data types and data length of communication data	18
6.2.2 Static data request.....	18
6.2.3 Dynamic data request.....	19
6.2.4 Registers assigned to PLC.....	21
6.3 Processing of Numeric Data Values	23

	Page
7. COMMUNICATION DATA MAP	24
7.1 Reference to Communication Data Map	24
7.2 Communication Data Map	25
8. USAGE EXAMPLE	55
8.1 Handling Procedures	55
8.2 System Configuration	56
8.3 Use Instruments Setting.....	57
8.4 PLC Tool Setting.....	58
9. TROUBLESHOOTING.....	75
10. SPECIFICATIONS	77

1. OUTLINE

This manual describes the communication specifications, mounting, wiring, setting and data instructions for the PROFIBUS Communication Converter COM-JG.

PROFIBUS Communication Converter COM-JG (hereafter called COM-JG) is communication converter to connect the RKC temperature controller (FB100/400/900) to a programmable controller (hereafter called PLC) for PROFIBUS.

The COM-JG supports PROFIBUS-DP protocol. This protocol includes master and slave. The PLC is the master and the COM-JG is the slave.

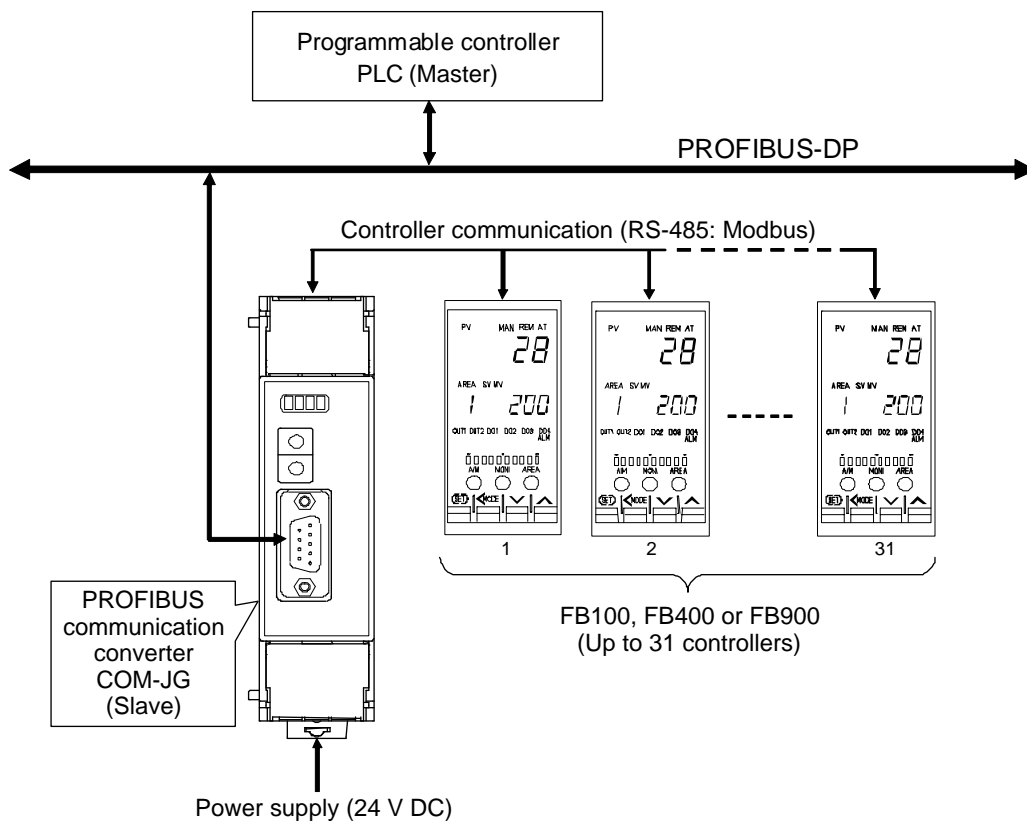

👉 For PROFIBUS, refer to the website of PROFIBUS International.
URL: <http://www.profibus.com/>

1.1 Product Check

Before using this product, check each of the following.

- Model code
- Check that there are no scratches or breakage in external appearance (case, front panel, terminal, etc).
- Check that all of the accessories delivered are complete. (See below)

Accessories	Q'TY	Remarks
<input type="checkbox"/> COM-JG [For FB100/FB400/FB900] Installation Manual (IMR01Y03-E□)	1	Enclosed with instrument
<input type="checkbox"/> COM-JG [For FB100/FB400/FB900] Quick Instruction Manual (IMR01Y13-E□)	1	Enclosed with instrument
<input type="checkbox"/> COM-JG [For FB100/FB400/FB900] Communication Data List (IMR01Y18-E□)	1	Enclosed with instrument
<input type="checkbox"/> COM-JG [For FB100/FB400/FB900] Instruction Manual (IMR01Y08-E5)	1	This manual (Download free or purchase hard copy)
<input type="checkbox"/> GSD file (rkc_0919.gsd) *	1	Download free



If any of the products are missing, damaged, or if your manual is incomplete, please contact RKC sales office or the agent.

* GSD file

The GSD file for COM-JG can be downloaded from our website.

(URL: http://www.rkcinst.com/english/download/field_network.htm)

1.2 Model Code

Check that the product received is correctly specified by referring to the following model code list:

If the product is not identical to the specifications, please contact RKC sales office or the agent.

COM- JG * 01

(1)

(1) Corresponding to the RKC controller

01: FB100/400/900

1.3 Parts Description

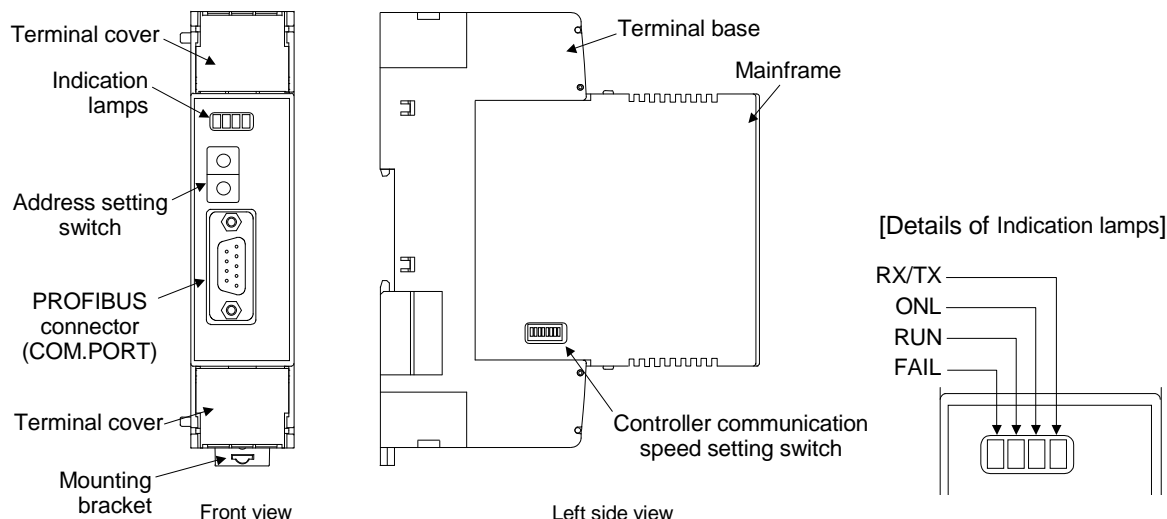

● **Indication lamps**

FAIL [Red]	<ul style="list-style-type: none"> When instrument abnormally: Turns on
RUN [Green]	<ul style="list-style-type: none"> When normally: Turns on Operation error: Flashes slowly During controller communication initialization: Flashes rapidly
ONL [Green]	During PROFIBUS connection establishment: Turns on
RX/TX [Green]	During PROFIBUS data send and receive: Flashes

● **PROFIBUS connector**

COM. PORT	Connector for PLC (Master) connection
-----------	---------------------------------------

● **Switches**

Address setting switch	Set the address for PROFIBUS
Controller communication speed setting switch	Set the communication speed for controller communication

● **Others**

Terminal cover	Terminal covers above and below the COM-JG
Mounting bracket	<ul style="list-style-type: none"> Used for the DIN rail mounting When panel mounted, two mounting brackets are required for the upper and lower sides (one required for the upper side: separately sold).
Terminal base	Part of the terminal and base of COM-JG (There is the Termination resistor transfer switch in the inside of terminal base)
Mainframe	Part of the mainframe of COM-JG

2. HANDLING PROCEDURES

Conduct the setting necessary for performing communication in accordance with the following procedure.

COM-JG Setting

Set the PROFIBUS address of COM-JG and controller communication speed.

 Refer to **5. SETTING (P. 15)**



Mounting

Install the COM-JG.

 • Refer to **3. MOUNTING (P. 5)**
• For controller, refer to **FB100 Installation Manual (IMR01W12-E□)** or **FB400/FB900 Installation Manual (IMR01W01-E□)**



Wiring and Connection

Connect power supply wires to the COM-JG, and also connect the COM-JG to the controller and the COM-JG to the PLC, respectively.

 • Refer to **4. WIRING (P. 8)**
• For controller, refer to **FB100 Installation Manual (IMR01W12-E□)** or **FB400/FB900 Installation Manual (IMR01W01-E□)**



Controller Setting

Set communication parameters of controller.

 • Refer to **8.3 Use Instruments Setting (P. 57)**
• Refer to **FB100 Communication Quick Manual (IMR01W15-□)**
• Refer to **FB400/FB900 Communication Quick Manual (IMR01W07-E□)**



PLC tool Setting

Set PLC programming software STEP7.

 Refer to **8.4 PLC Tool Setting (P. 58)**



To avoid error at operation start-up, COM-JG must be powered on LAST (after the controller, PLC, etc.).

3. MOUNTING

This chapter describes installation environment, mounting cautions, dimensions and mounting procedures.



WARNING

To prevent electric shock or instrument failure, always turn off the power before mounting or removing the instrument.

3.1 Mounting Cautions

- (1) This instrument is intended to be used under the following environmental conditions. **(IEC61010-1)**
[OVERVOLTAGE CATEGORY II, POLLUTION DEGREE 2]
- (2) Use this instrument within the following environment conditions:
 - Allowable ambient temperature: -10 to $+50$ °C
 - Allowable ambient humidity: 5 to 95 % RH
(Absolute humidity: MAX.W.C 29.3 g/m³ dry air at 101.3 kPa)
 - Installation environment conditions:
 - Indoor use
 - Altitude up to 2000 m
- (3) Avoid the following conditions when selecting the mounting location:
 - Rapid changes in ambient temperature which may cause condensation.
 - Corrosive or inflammable gases.
 - Direct vibration or shock to the mainframe.
 - Water, oil, chemicals, vapor or steam splashes.
 - Excessive dust, salt or iron particles.
 - Excessive induction noise, static electricity, magnetic fields or noise.
 - Direct air flow from an air conditioner.
 - Exposure to direct sunlight.
 - Excessive heat accumulation.
- (4) Mount this instrument in the panel considering the following conditions:
 - Ensure at least 50 mm space on top and bottom of the instrument for maintenance and environmental reasons.
 - Do not mount this instrument directly above equipment that generates large amount of heat (heaters, transformers, semi-conductor functional devices, large-wattage resistors).
 - If the ambient temperature rises above 50 °C, cool this instrument with a forced air fan, cooler, etc. Cooled air should not blow directly on this instrument.
 - In order to improve safety and the immunity to withstand noise, mount this instrument as far away as possible from high voltage equipment, power lines, and rotating machinery.
 - High voltage equipment: Do not mount within the same panel.
 - Power lines: Separate at least 200 mm.
 - Rotating machinery: Separate as far as possible.
- (5) If this instrument is permanently connected to equipment, it is important to include a switch or circuit-breaker into the installation. This should be in close proximity to the equipment and within easy reach of the operator. It should be marked as the disconnecting device for the equipment.

3.2 Dimensions

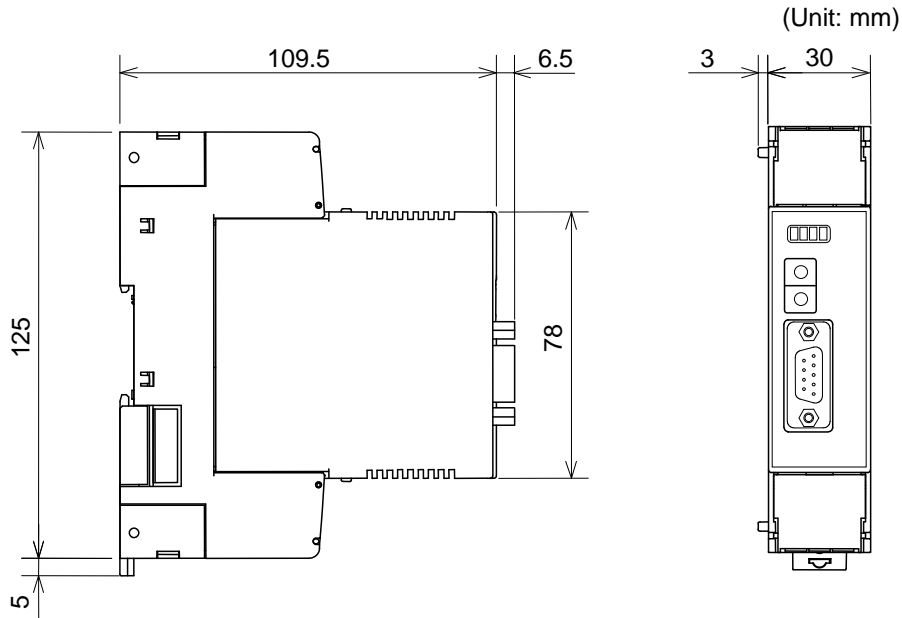

3.3 DIN Rail Mounting

■ Mounting procedures

1. Pull down the mounting bracket at the bottom of the instrument (A). Attach the hooks on the top of the instrument to the DIN rail and push the lower section into place on the DIN rail (B).
2. Slide the mounting bracket up to secure the instrument to the DIN rail (C).

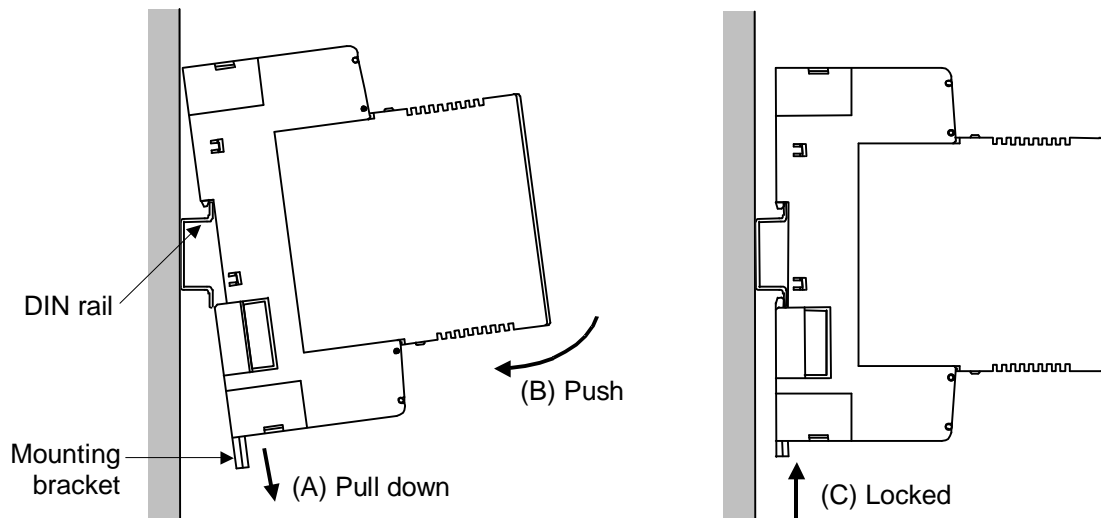

■ Removal procedures

1. Turn the power OFF.
2. Remove the wiring.
3. Pull down a mounting bracket with a blade screwdriver (A). Lift the instrument from bottom, and take it off (B).

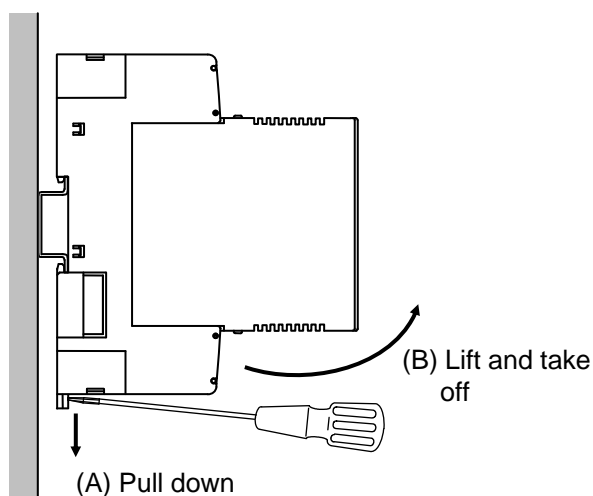

3.4 Panel Mounting

■ Mounting procedures

1. Pull down the mounting bracket (A) until locked and that a mounting hole appears.
2. Prepare one mounting bracket per instrument (B) sold separately (KSRX-55) and then insert it in the rear of the terminal board at top of the instrument until locked but a mounting hole does not disappear.
3. Mount each module directly on the panel with screws which are inserted in the mounting holes of the top and bottom mounting brackets.

Recommended tightening torque: 0.3 N·m (3 kgf·cm)



The customer needs to provide the M3 size screws. Select the screw length that matches the mounting panel.

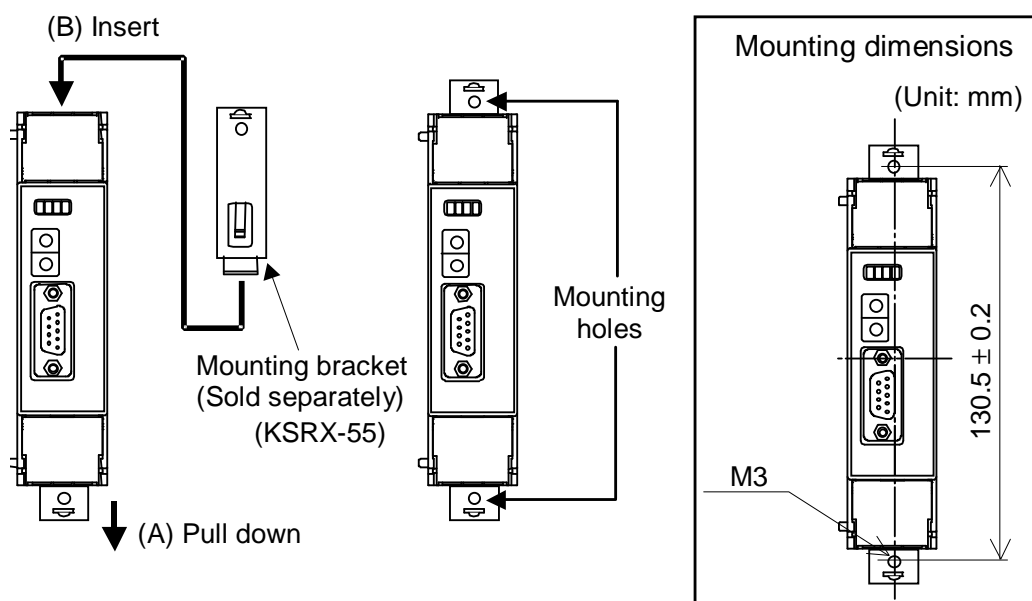

4. WIRING

This chapter describes wiring cautions, terminal configuration and connections.

4.1 Wiring Cautions



WARNING

To prevent electric shock or instrument failure, do not turn on the power until all wiring is completed. Make sure that the wiring is correct before applying power to the instrument.

- To avoid noise induction, keep communication signal wire away from instrument power line, load lines and power lines of other electric equipment.
- If there is electrical noise in the vicinity of the instrument that could affect operation, use a noise filter.
 - Shorten the distance between the twisted power supply wire pitches to achieve the most effective noise reduction.
 - Always install the noise filter on a grounded panel. Minimize the wiring distance between the noise filter output and the instrument power supply terminals to achieve the most effective noise reduction.
 - Do not connect fuses or switches to the noise filter output wiring as this will reduce the effectiveness of the noise filter.
- Power supply wiring must be twisted and have a low voltage drop.
- For an instrument with 24 V power supply, supply power from a SELV circuit.
- A suitable power supply should be considered in end-use equipment. The power supply must be in compliance with a limited-energy circuits (maximum available current of 8 A).
- Use the solderless terminal appropriate to the screw size (M3).

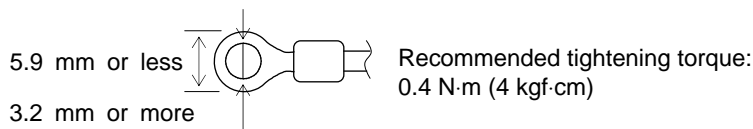



- Make sure that the any wiring such as solderless terminal is not in contact with the adjoining terminals.

4.2 Terminal Configuration

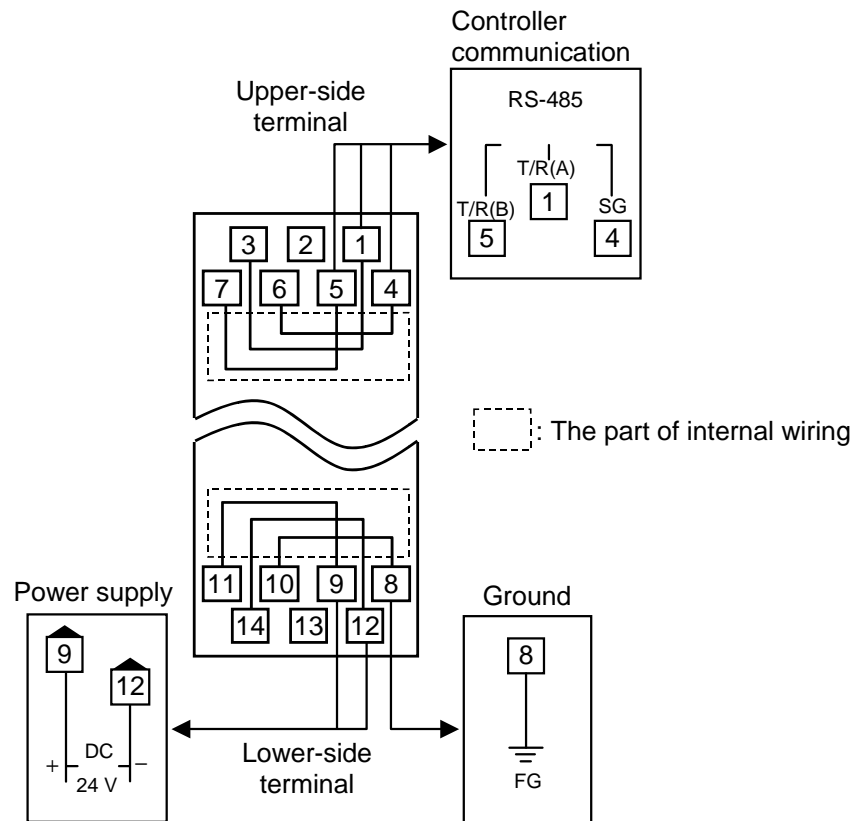
The terminal layout is as follows.



-  As controller communication terminal Nos. 1, 4 and 5 are internally connected to terminal Nos. 3, 6 and 7, any terminals can be used.
-  As ground and power supply terminal Nos. 8, 9 and 12 are internally connected to terminal Nos. 10, 11 and 14, any terminals can be used.
-  Terminal No. 2 and No. 13 is not used.

4.3 Connection to PROFIBUS

Connect COM-JG to PROFIBUS.

■ Pin layout of connector

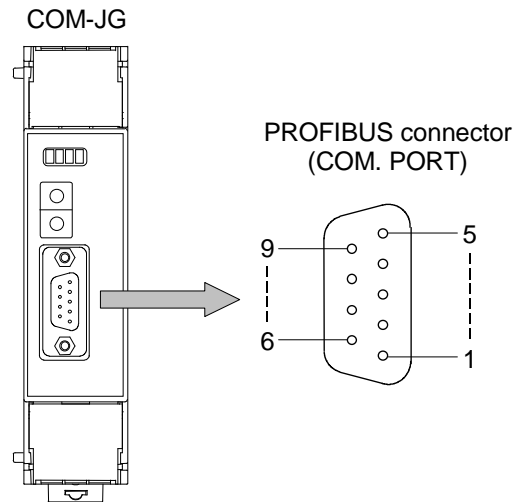

Pin No.	Signal name	Symbol
1	—	Unused
2	—	Unused
3	Receive data /Transmission data (plus)	RxD/TxD-P
4	—	Unused
5	Signal ground	DGND
6	Termination resistor supply voltage (5 V)	VP
7	—	Unused
8	Receive data /Transmission data (negative)	RxD/TxD-N
9	—	Unused

 For the connectable connector of the PLC, refer to the instruction manual for the used PLC.

■ PROFIBUS cables

Use the PROFIBUS cable which fitted the following requirement.

- Use the shielded twisted pair wire
- Based on IEC61158, Standard (Recommend cable type A)

Cable type A specification

Impedance:	135 to 165 Ω
Capacitance:	< 30 pF/m
Loop resistance:	110 Ω /km
Core diameter:	0.64 mm
Core cross section:	> 0.34 mm ²

Maximum cable length by communication speed (For cable type A)

Communication speed (kbps)	9.6	19.2	93.75	187.5	500	1500	12000
Cable length (m)	1200	1200	1200	1000	400	200	100

- Connect the termination resistor to the end of a bus (See below)

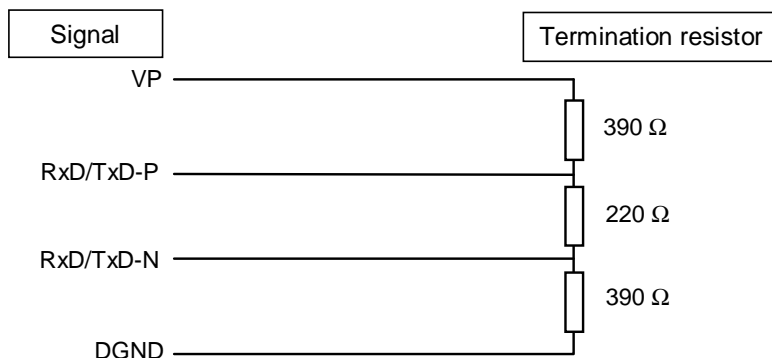

Customer must provide the PROFIBUS cable (a connection cable of PLC and COM-JG). As for the PROFIBUS cable, there is a case prepared by a PLC manufacturer.



The details except the above are connected to a website of PROFIBUS International, and obtain necessary information.

URL: <http://www.profibus.com/>

4.4 Connection to the Controllers

Conduct wiring between the COM-JG and controller (FB100/400/900) as shown in the following.



When conducting wiring to the FB100/400/900, always conduct wiring to the Communication 1 terminal.

■ FB100/400/900 communication terminal number and signal details

Terminal No.		Signal name	Symbol
FB100	FB400/900		
13	25	Signal ground	SG
14	26	Send/Receive data	T/R (A)
15	27	Send/Receive data	T/R (B)

■ Wiring example [FB400/900] (Connections are similar for the FB100)

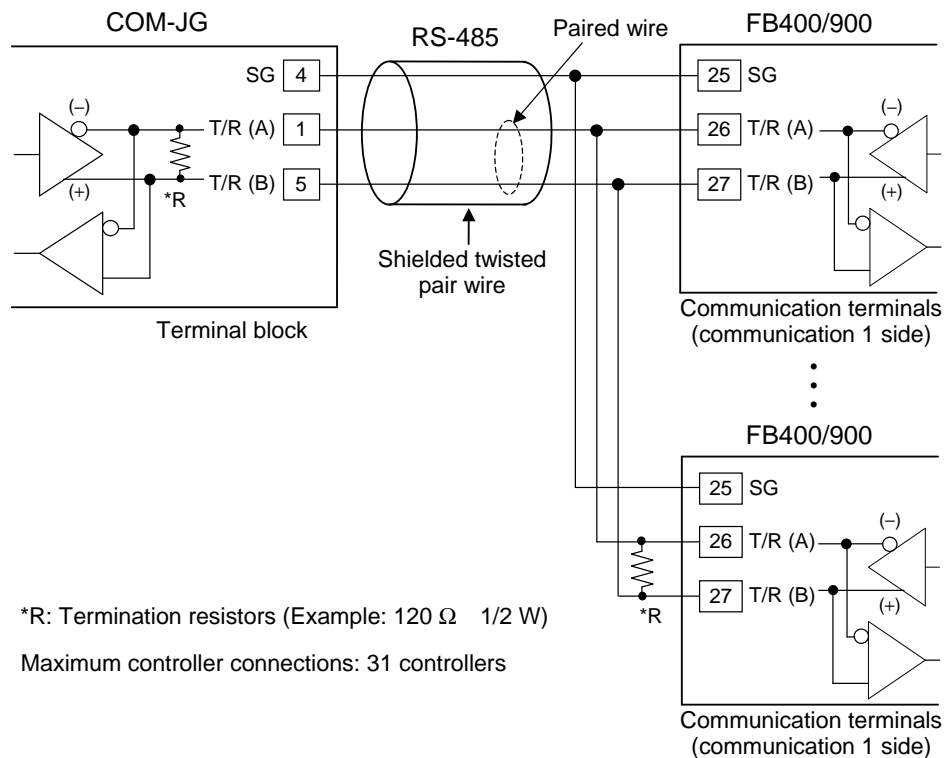

The cable is provided by the customer.



The termination resistor existing within the COM-JG can be connected or disconnected by the switch. (Factory set value: Termination resistor connected)

[Refer to **4.5 Installation of Termination Resistor (P. 13)**]

4.5 Installation of Termination Resistor

Procedure for setting a termination resistor to Controller communication (RS-485) and its setting position are described in the following.

■ Termination resistor setting position

If the COM-JG is connected to the extreme end of the communication line, install one termination resistor each to the COM-JG and the controller located most distantly from the COM-JG.

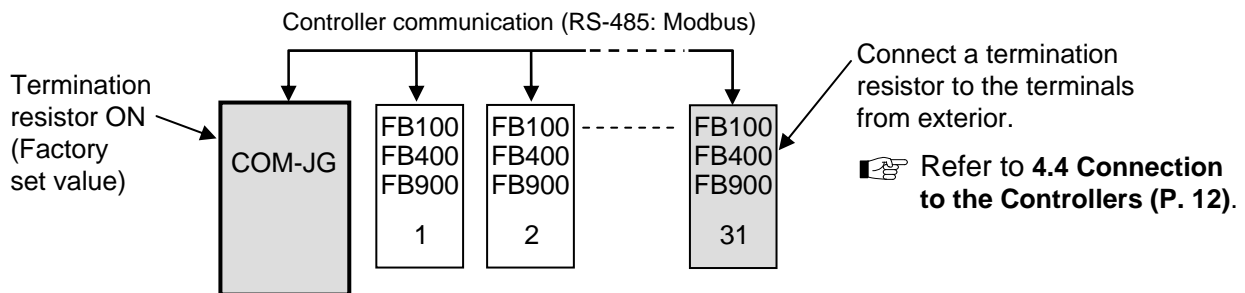

■ Setting procedure of termination resistor (COM-JG)

As the COM-JG is internally provided with a selector switch for choosing the ON/OFF of a termination resistor, it is not required to externally install the termination resistor.
(Factory set value: Termination resistor connected)

1. Turn off the power supply of the COM-JG.
Do not separate the mainframe from terminal base with the power turned on. If so, instrument failure may result.
2. Pull out the mainframe itself toward you while pushing the locks at its top and bottom (1), and then separate it from the terminal base (2).

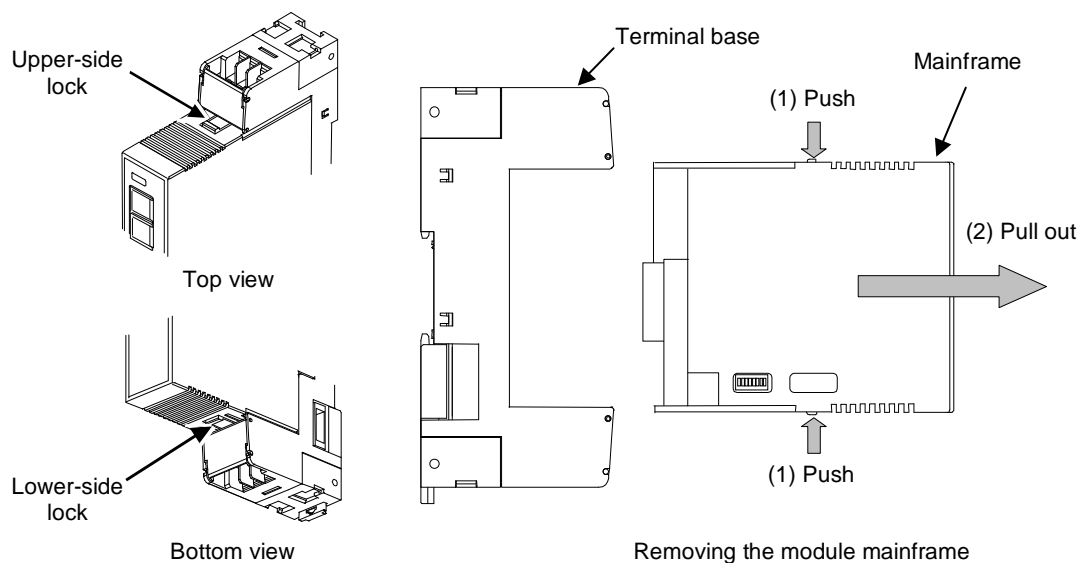

3. Turn on the Termination resistor transfer switch in the terminal base.
The COM-JG is shipped from the factory with the selector switch set to “ON: Termination resistor connected.”

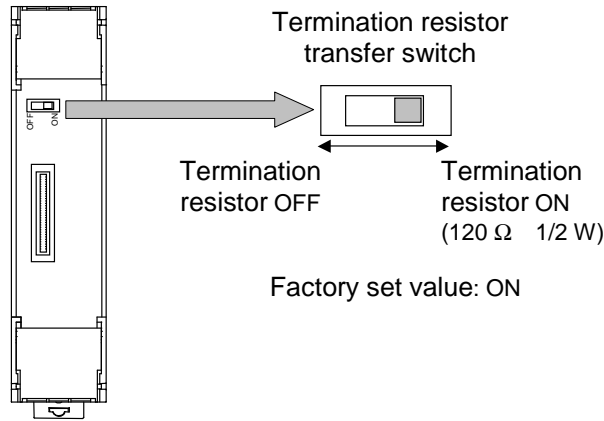

A terminal base of the state which removed module mainframe

4. Push the mainframe thus separated in the terminal base until firmly locked.

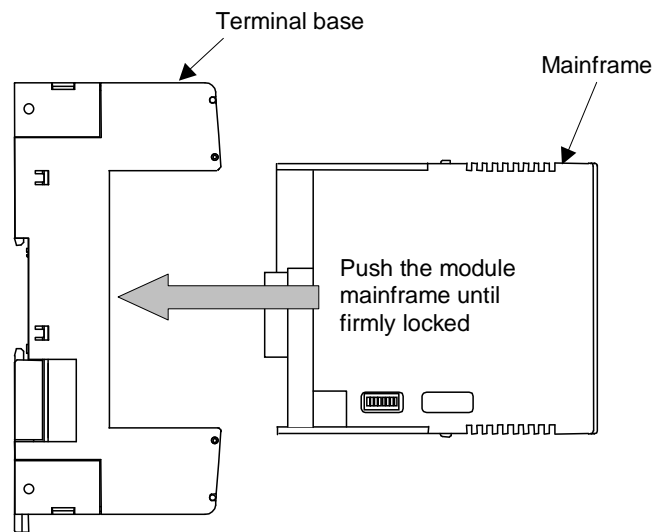

Mounting the module mainframe

5. SETTING



WARNING

- To prevent electric shock or instrument failure, always turn off the power before setting the switch.
- To prevent electric shock or instrument failure, never touch any section other than those instructed in this manual.

CAUTION

Do not separate the mainframe from the terminal base with the power turned on. If so, instrument failure may result.

5.1 PROFIBUS Address Setting

The master communicates with the selected slave by specifying that slave's address number. Each slave must have a unique address number for this data transmission. Set the slave address with the address setting switch prior to operation.

With the tow rotary switch in the front of the COM-JG, set an address number on the PROFIBUS. For this setting, use a small blade screwdriver.



No communication with PROFIBUS can be conducted with each factory set value (00H) left as it is. Set it to the same value as the PROFIBUS address set when system configured.

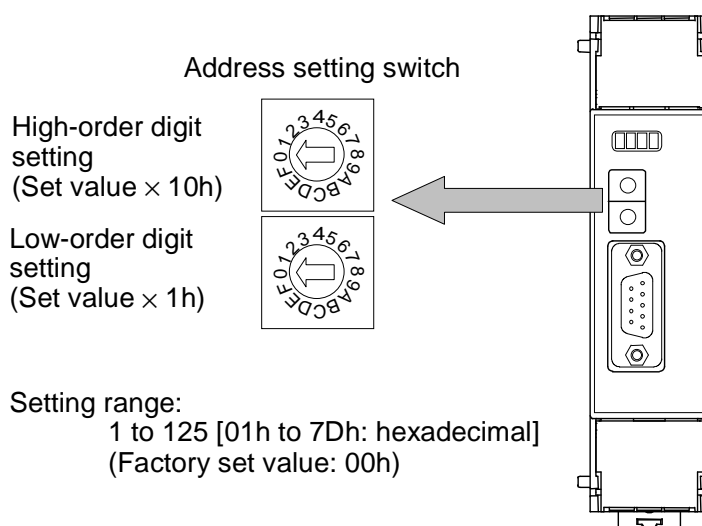

5.2 Controller Communication Speed Setting

The speed of communication with the controller (FB100/400/900) is set by the dip switch at the left side of the mainframe. In addition, it is selected whether or not the device address on the controller side is set as a continuous or free address.

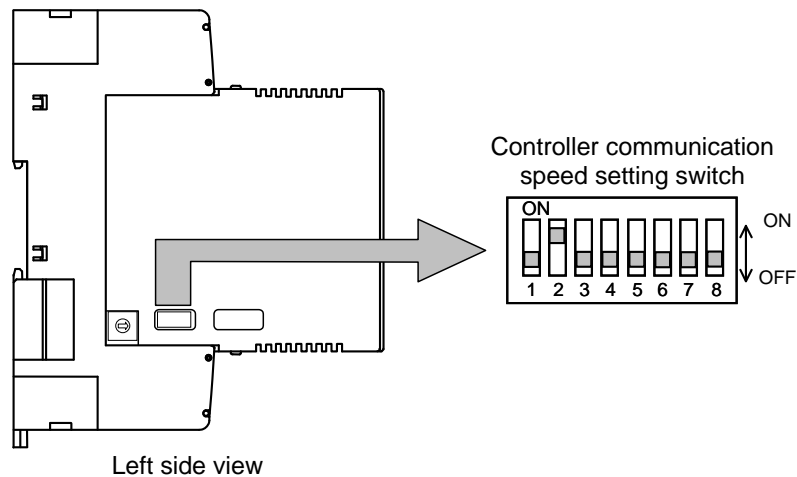

1	2	Controller communication speed
OFF	OFF	38400 bps
ON	OFF	9600 bps
OFF	ON	19200 bps
ON	ON	38400 bps

Factory set value: 19200 bps

5	Controller address setting mode
OFF	Continuous setting (Consecutive addresses starting from 1 are set to the controllers)
ON	Free setting (Addresses are freely set to the controllers in the range of 1 to 31)

Factory set value: Continuous setting



For the continuous setting, always set device addresses of the controller to consecutive numbers starting from “1.” Otherwise instrument failure or malfunction may result.

3	4	6	7	8	
OFF	OFF	OFF	OFF	OFF	Fixed (Do not change the factory set value)



Dip switch No. 3, 4, 6, 7 and 8 must be always OFF. Do not set to ON.

6. PROFIBUS COMMUNICATION

6.1 PROFIBUS System Configuration

For system configuration with PROFIBUS-DP protocol, have to offer the communication information about each slave for a master in the form of electronic device data seat (GSD file).

A manufacturer of PLC (master) has prepared configuration tool for a system configuration of PROFIBUS. By combining all GSD files of the slaves to be connected, the configuration tool creates a master parameter record containing all pertinent data for the bus system. The configuration of a PROFIBUS system is enabled by downloading these data to a master.

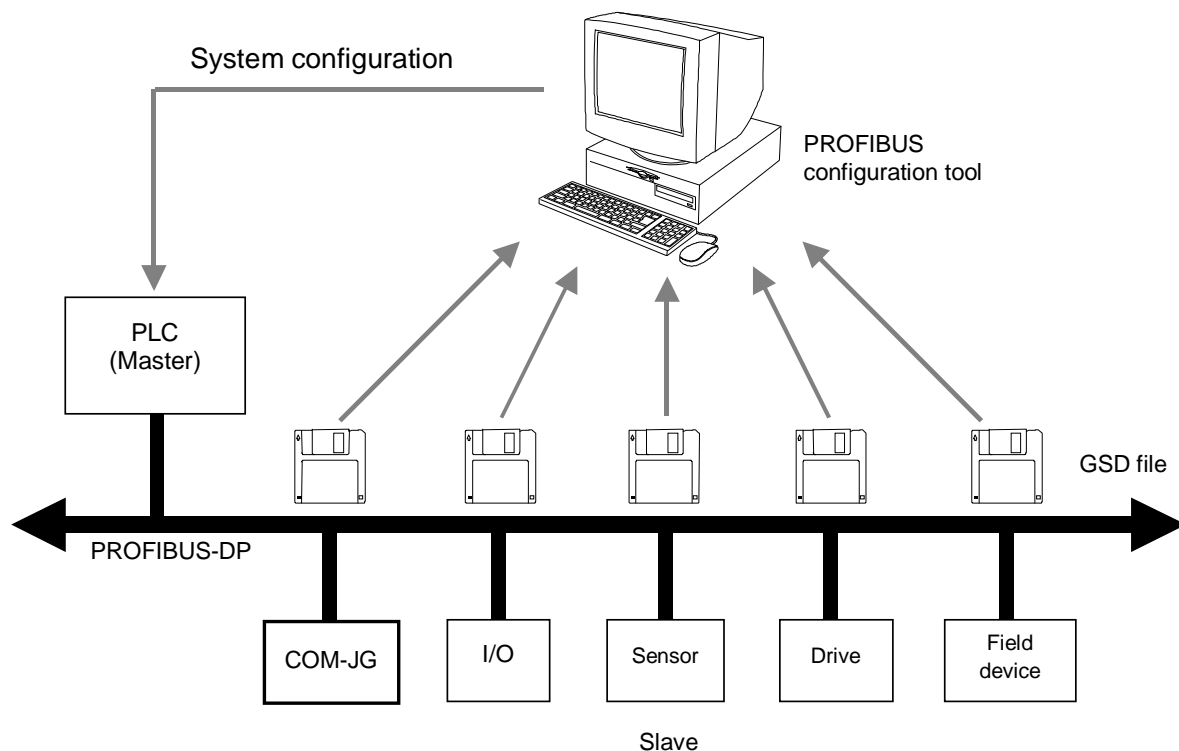

Overview of PROFIBUS system configuration



About configuration tool, please ask a manufacturer of a master product.

6.2 PROFIBUS Communication Data

6.2.1 Data types and data length of communication data

■ Data access types

- Static data read/write
- Dynamic data read/write
- Error state register
- Write permission register

■ Communication data length

A maximum of 170 bytes can be read or written.

● Static data request

The maximum number of communication items which can be specified:

40 items (Read items + Write items)

The communication items which can be specified:

Data of the **7. COMMUNICATION DATA MAP (P. 24)**

● Dynamic data request

The communication items which can be requested:

Data of the **7. COMMUNICATION DATA MAP (P. 24)**



The number of communication items becomes as follows depending on the number of connecting controllers.

Number of static data × Number of connection controller × 2 + Number of dynamic data × 6 + 4 ≤ 170

Number of connection controllers	Number of static data
1 controller	Up to 40 items including both read and write items.
16 controllers	Up to 5 items including both read and write items.
31 controllers	Up to 2 items including both read and write items.

6.2.2 Static data request

- Static data is that which is always read/written from/to the PROFIBUS master such as the PLC.
The data item is selected by the configuration tool such as the PLC.
- As the Modbus register address is directly specified, data items of all the controllers connected to the COM-JG can be selected.
- When static data is requested, 1-word (2-byte) data is used for both read and write.



As the static data register address is set when system configured, it is not required to create a sequence program for static data assignment.

6.2.3 Dynamic data request

- Dynamic data is that which is freely read/written from/to the PROFIBUS master such as the PLC. The data item is freely selected by the sequence program.
- As the Modbus register address is directly specified, data items of all the controllers connected to the COM-JG can be selected.
- When dynamic data is requested, 3-word (6-byte) data is used for both read and write.

■ Send data from PLC to COM-JG

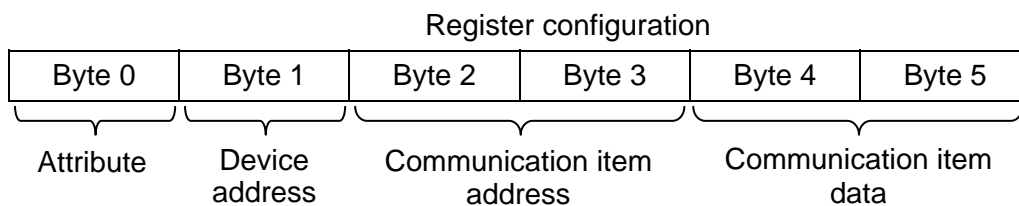

- **Byte 0:** Specify an attribute of data. Only Bit 7 and Bit 6 are used.

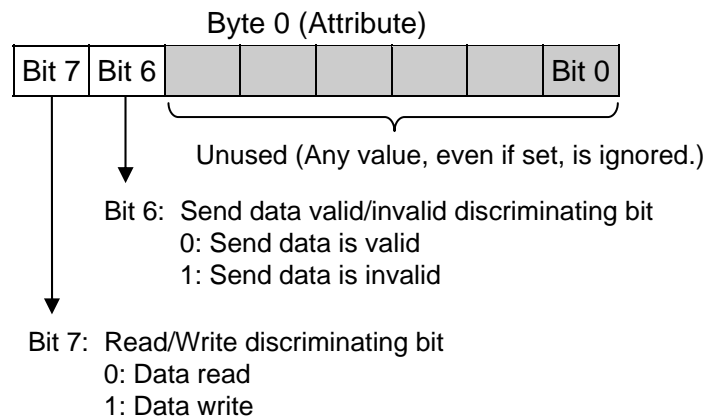

- **Byte 1:** Specify an accessing device address of controller.
Data range: 1 to 99 (“0” at Modbus is invalid)
- **Byte 2, Byte 3:** The communication item address of controller, to/from which data is written/read is specified.
Data address range: 0000H to 00DAH
Address range of memory area: 0500H to 0514H
- **Byte 4, Byte 5:** Write data of a communication item.
 - If Bit 7 in Byte 0 is set to “1: Data write,” data in the address specified by Bytes 1, 2, and 3 is written.
 - If Bit 7 in Byte 0 is set to “0: Data read,” data in Byte 4 and 5 will be ignored.

 For communication item, refer to **7. COMMUNICATION DATA MAP (P. 24)**.

■ PLC received data from COM-JG

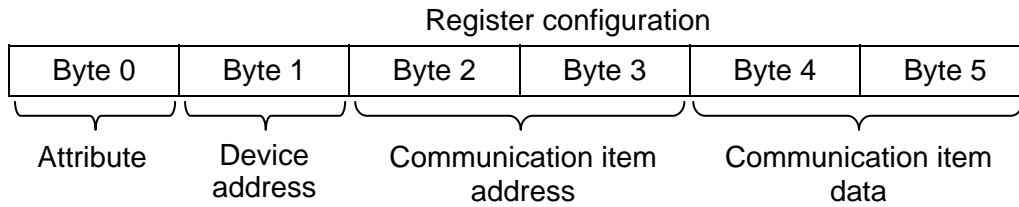

- **Byte 0:** **Echo back of Byte 0 of send data, and data updating state of controller (Bit 5)**

The details of data in Byte 0 sent to the controller from the PLC and data updating state of controller (Bit 5) are returned.

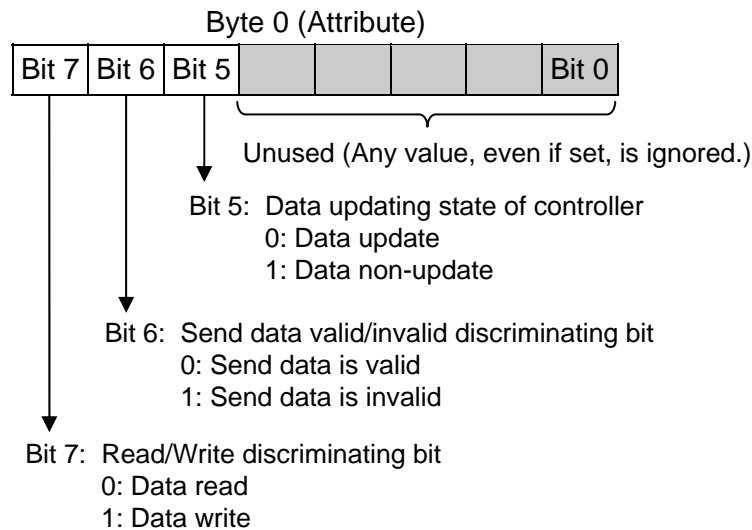

- **Byte 1:** **Echo back of Byte 1 of send data**

The specified controller device address is returned. However, if there is no specified device address, “FFH” is returned.

- **Byte 2, Byte 3:** **Echo back of Byte 2 and Byte 3 of send data**

The communication item address of controller, to/from which data is written/read is returned. However, if any communication item address out of the data range or of unused item is specified, “FFFFH” is returned.

Data address range: 0000H to 00DAH

Address range of memory area: 0500H to 0514H

- **Byte 4, Byte 5:** **Data of communication item**

– For data read, the current value of relevant communication item is stored.

– For data write, the current value of relevant communication item is stored.

If the written data is valid, the written value is returned.

If the written data is invalid, the present (before data write) value is returned.



When the data is written, there is a delay in rewriting the data in this register as the COM-JG updates the register after rereading the data on the controller.

6.2.4 Registers assigned to PLC

Set the register area after the GSD file is read to the configuration tool for the PLC.

The static data request read, static data request write and dynamic data request registers are set to the register area.

In addition to the above register area setting, the Error state and Write permission flags are set to the first two bytes of the read register and to the first one byte of the write register, respectively.

■ Error state register

The first read only 1-byte register consists of bits of error state.

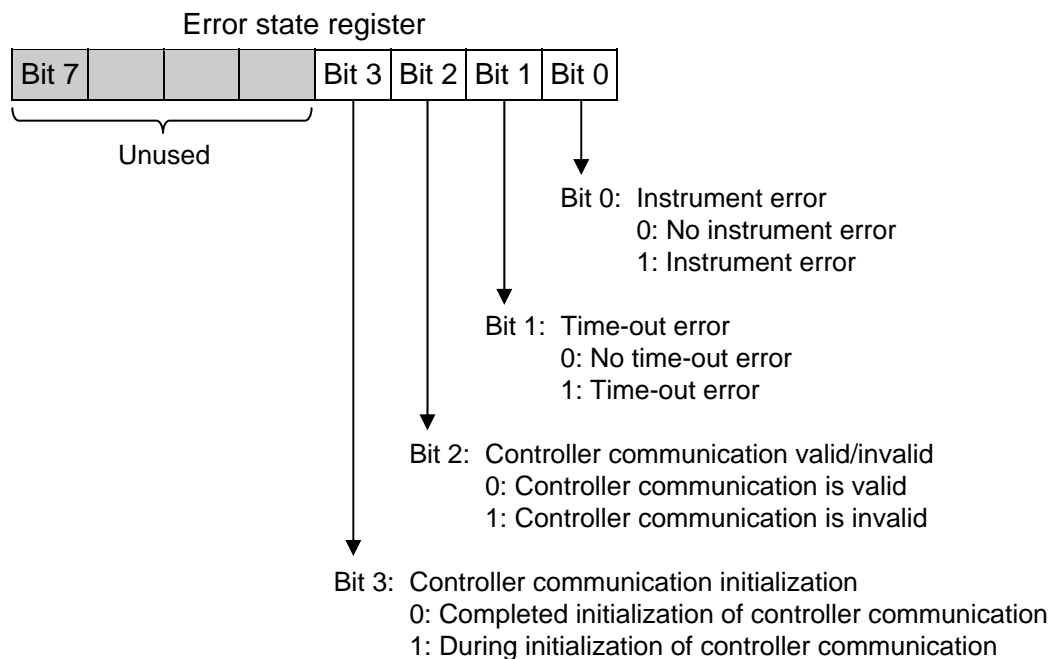

● Instrument error

In case of the following either, become an error.

- None of the controllers is connected.
- COM-JG is hardware abnormally.



If an instrument error occurs, the RUN lamp at the front of COM-JG flashes (flashes slowly.)

● Time-out error

Successive communication time-out occurring twice in the same controller after PROFIBUS is initialized causes a time-out error. Communication continues even during the time-out error and recovers with no time-out error when the communication returns to normal.

Time-out time: 3 seconds

- **Controller communication valid/invalid**

Interlocked with dip switch No. 7 at the side of the COM-JG.

Factory set value of dip switch No. 7: OFF (0: Controller communication valid)

- **Controller communication initialization**

Indicates the controller communication initialized state when the power is turned on and at this state invalidates the data on each communication item.

- **Write permission flags register**

Data may be written by static data request depending on the PLC even if the PLC is not in the RUN state. In order to prevent this, the COM-JG is provided with the 1-byte flag register.

Only when the flag value in this one byte corresponds to “0FH” (hexadecimal), data is written to each controller.



The operation of writing a hexadecimal value of “0FH” to the write permission flag register is necessary for both static and dynamic data requests.

6.3 Processing of Numeric Data Values

Numeric data values used via communication with the PLC and processed by COM-JG include those with and without decimal points and also those with minus signs.

- **For numeric data value without decimal point**

If there is no decimal point, the value is processed as it is.

In parameters which only have ON or OFF status, 1 = ON, 0 = OFF.

[Example]

A signal wire for temperature input is disconnected and the burnout state occurs.

→ Read value corresponding to communication item address 0005 (Burnout state monitor):
1 (Hexadecimal number: 0001H)

- **For numeric data value with decimal point**

The decimal point is omitted.

[Example 1]

When temperature measured value of controller is 120.5 °C

→ Read value corresponding to communication item address 0000 [Measured value (PV)]:
1205 (Hexadecimal number: 04B5H)

[Example 2]

When temperature measured value of controller is 130 °C

→ Read value corresponding to communication item address 0000 [Measured value (PV)]:
130 (Hexadecimal number: 0082H)

- **For numeric data value with minus sign**

The value is expressed as a 2's complement value which is obtained by subtracting the minus value from the hexadecimal number 10000H.

[Example 1]

When temperature measured value of controller is -1 °C

→ Read value corresponding to communication item address 0000 [Measured value (PV)]:
Hexadecimal number: FFFFH
(10000H - 1 = FFFFH)

[Example 2]

When temperature measured value of controller is -2.5 °C

→ Read value corresponding to communication item address 0000 [Measured value (PV)]:
Hexadecimal number: FFE7H
(10000H - 25 = 10000H - 19H = FFE7H)



The original minus value can be found by revising the WORD value to the INT value on the sequence program side.

7. COMMUNICATION DATA MAP

7.1 Reference to Communication Data Map

A data map of communication items shows data on controller (FB100/400/900) which can make communication via PROFIBUS.

No.	Name	Communication item address (Modbus register address)		Attribute	Data range	Factory set value
		HEX	DEC			
1	Measured value (PV)	0000	0	RO	Input scale low to Input scale high	—
2	Current transformer 1 (CT1) input value monitor	0001	1	RO	CTL-6-P-N: 0.0 to 30.0A	—
3	Current transformer 2 (CT2) input value monitor	0002	2	RO	CTL-12-S56-10L-N: 0.0 to 100.0 A	—
4	Set value (SV) monitor	0003	3	RO	Setting limiter low to Setting limiter high	—
5	Remote setting (RS) input value monitor	0004	4	RO	Setting limiter low to Setting limiter high	—
6	Burnout state monitor	0005	5	RO	0: OFF 1: ON	—

(1) Name: Communication item name

(2) Communication item address (Modbus register address):

The communication item address is the address number to specify with configuration tool when carry out read/write of data.

HEX: Hexadecimal

DEC: Decimal

(3) Attribute: RO: Read only data

Data direction: Master (PLC) → Slave (COM-JG)

R/W: Read and Write data

Data direction: Master (PLC) ↔ Slave (COM-JG)

(4) Data range: The data range of communication item



Bit image of bit data is as follows.

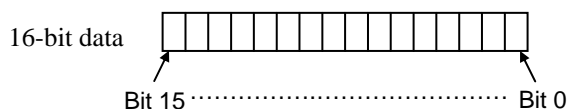

(5) Factory set value: Factory set value of communication item

7.2 Communication Data Map

No.	Name	Communication item address (Modbus register address)		Attribute	Data range	Factory set value
		HEX	DEC			
1	Measured value (PV)	0000	0	RO	Input scale low to Input scale high	—
2	Current transformer 1 (CT1) input value monitor	0001	1	RO	CTL-6-P-N: 0.0 to 30.0 A CTL-12-S56-10L-N: 0.0 to 100.0 A	—
3	Current transformer 2 (CT2) input value monitor	0002	2	RO		—
4	Set value (SV) monitor	0003	3	RO	Setting limiter low to Setting limiter high	—
5	Remote setting (RS) input value monitor	0004	4	RO	Setting limiter low to Setting limiter high	—
6	Burnout state monitor	0005	5	RO	0: OFF 1: ON	—
7	Burnout state monitor of feedback resistance input	0006	6	RO	0: OFF 1: ON	—
8	Event 1 state monitor	0007	7	RO	0: OFF 1: ON	—
9	Event 2 state monitor	0008	8	RO		—
10	Event 3 state monitor	0009	9	RO		—
11	Event 4 state monitor	000A	10	RO		—
12	Heater break alarm 1 (HBA1) state monitor	000B	11	RO	0: OFF 1: ON	—
13	Heater break alarm 2 (HBA2) state monitor	000C	12	RO		—
14	Manipulated output value (MV1) monitor [heat-side]	000D	13	RO	PID control or Heat/Cool PID control: -5.0 to +105.0 % Position proportioning control with feedback resistance (FBR) input: 0.0 to 100.0 %	—
15	Manipulated output value (MV2) monitor [cool-side]	000E	14	RO	-5.0 to +105.0 %	—
16	Error code	000F	15	RO	Bit data Bit 0: Adjustment data error Bit 1: Back-up error Bit 2: A/D conversion error Bit 3: Unused Bit 4: Unused Bit 5: Custom data error Bit 6: Unused Bit 7: Watchdog timer error Bit 8: Stack overflow Bit 9 to Bit 10: Unused Bit 11: Program error (busy) Bit 12 to Bit 15: Unused Data 0: OFF 1: ON [Decimal number: 0 to 2471]	

Continued on the next page.

Continued from the previous page.

No.	Name	Communication item address (Modbus register address)		Attribute	Data range	Factory set value
		HEX	DEC			
17	Digital input (DI) state monitor	0010	16	RO	Bit data Bit 0: DI1 Bit 1: DI2 Bit 2: DI3 Bit 3: DI4 Bit 4: DI5 Bit 5: DI6 * Bit 6: DI7 * Bit 7 to Bit 15: Unused Data 0: Contact open 1: Contact closed [Decimal number: 0 to 127] * Unused on the FB100.	—
18	Output state monitor	0011	17	RO	Bit data Bit 0: OUT1 Bit 1: OUT2 Bit 2: DO1 Bit 3: DO2 Bit 4: DO3 * Bit 5: DO4 * Bit 6 to Bit 15: Unused Data 0: OFF 1: ON [Decimal number: 0 to 63] * Unused on the FB100.	—
19	Operation mode state monitor	0012	18	RO	Bit data Bit 0: Control STOP Bit 1: Control RUN Bit 2: Manual mode * Bit 3: Remote mode * Bit 4 to Bit 15: Unused Data 0: OFF 1: ON [Decimal number: 0 to 15] * During operation in Manual mode, the Manual mode of the Operation mode state monitor is set to the "1: ON" state and the Remote mode of the same monitor is set to the "0: OFF" state even if the parameter, Remote/Local transfer is set to "1: Remote mode."	—
20	Memory area soak time monitor	0013	19	RO	0 to 11999 seconds or 0 to 5999 minutes Data range of Area soak time can be selected on the Soak time unit.	—
21	Integrated operating time monitor	0014	20	RO	0 to 19999 hours	—
22	Holding peak value ambient temperature monitor	0015	21	RO	-10.0 to +100.0 °C	—
23	Power feed forward input value monitor ♦	0016	22	RO	0.0 to 160.0 % Display in the percentage of the load voltage (rated value).	—

♦ Unused on the FB100.

Continued on the next page.

Continued from the previous page.

No.	Name	Communication item address (Modbus register address)		Attribute	Data range	Factory set value
		HEX	DEC			
24	Backup memory state monitor	0017	23	RO	0: The content of the backup memory does not coincide with that of the RAM. 1: The content of the backup memory coincides with that of the RAM.	—
25 ⋮ 32	Unused	0018 ⋮ 001F	24 ⋮ 31	—	—	—
33	PID/AT transfer	0020	32	R/W	0: PID control 1: Autotuning (AT) * * Automatically reverts to 0 after autotuning ends.	0
34	Auto/Manual transfer	0021	33	R/W	0: Auto mode 1: Manual mode	0
35	Remote/Local transfer	0022	34	R/W	0: Local mode 1: Remote mode When performing Remote control by Remote setting input and also performing Cascade control and Ratio setting via Intercontroller communication, transfer to the Remote mode. [FB100] When the Remote setting (RS) input is not provided, this data becomes RO (Read only data).	0
36	RUN/STOP transfer	0023	35	R/W	0: RUN mode (Control start) 1: STOP mode (Control stop)	0
37	Memory area transfer	0024	36	R/W	1 to 8 [FB100] When the Digital input (DI) assignment (No. 95) value is 6 to 12 and Control area Local/External transfer * is External mode, this data becomes RO (Read only data). * Operation of Control area Local/External transfer is only available for FB100.	1
38	Interlock release	0025	37	R/W	0: Interlock release (Execution/State) 1: Interlock An event whose event interlock is set to "1: Used" is set to the event ON state results in "1: Interlocked state." "1" is for monitoring the interlocked state. Under this condition, do not write "1."	0

Continued on the next page.

Continued from the previous page.

No.	Name	Communication item address (Modbus register address)		Attribute	Data range	Factory set value
		HEX	DEC			
39	Event 1 set value (EV1)	0026	38	R/W	Deviation: –Input span to +Input span Process and set value: Input scale low to Input scale high Manipulated output value (MV1 or MV2): –5.0 to +105.0 % If the Event type corresponds to “0: None,” set to RO (Read only data). If Event 4 corresponds to “9: Control loop break alarm (LBA),” the Event 4 set value becomes RO (Read only data).	50
40	Event 2 set value (EV2)	0027	39	R/W		50
41	Event 3 set value (EV3)	0028	40	R/W		50
42	Event 4 set value (EV4)	0029	41	R/W		50
43	Control loop break alarm (LBA) time	002A	42	R/W	0 to 7200 seconds (0: Unused) If Event 4 is other than “9: Control loop break alarm (LBA),” set to RO (Read only data).	480
44	LBA deadband	002B	43	R/W	0 to Input span If Event 4 is other than “9: Control loop break alarm (LBA),” set to RO (Read only data).	0
45	Set value (SV)	002C	44	R/W	Setting limiter low to Setting limiter high	TC/RTD: 0 V/I: 0.0
46	Proportional band [heat-side]	002D	45	R/W	TC/RTD inputs: 0 (0.0, 0.00) to Input span (Unit: °C [°F]) Varies with the setting of the Decimal point position selection. Voltage (V)/Current (I) inputs: 0.0 to 1000.0 % of input span (0, 0.0 or 0.00: ON/OFF action)	TC/RTD: 30 V/I: 30.0
47	Integral time [heat-side]	002E	46	R/W	PID control or Heat/Cool PID control: 0 to 3600 seconds or 0.0 to 1999.9 seconds (0, 0.0: PD action) * Position proportioning control: 1 to 3600 seconds or 0.1 to 1999.9 seconds Varies with the setting of the Integral/Derivative time decimal point position selection.	240
48	Derivative time [heat-side]	002F	47	R/W	0 to 3600 seconds or 0.0 to 1999.9 seconds (0, 0.0: PI action) Varies with the setting of the Integral/Derivative time decimal point position selection.	60

* When the heat-side or cool-side integral time is set to zero for Heat/Cool PID control, PD action will take place for both heat-side and cool-side.

Continued on the next page.

Continued from the previous page.

No.	Name	Communication item address (Modbus register address)		Attribute	Data range	Factory set value
		HEX	DEC			
49	Control response parameter	0030	48	R/W	0: Slow 1: Medium 2: Fast When the P or PD action is selected, this setting becomes invalid.	PID control, Position proportioning control: 0 Heat/Cool PID control: 2
50	Proportional band [cool-side]	0031	49	R/W	TC/RTD inputs: 1 (0.1, 0.01) to Input span (Unit: °C [°F]) Varies with the setting of the Decimal point position selection. Voltage (V)/Current (I) inputs: 0.1 to 1000.0 % of input span If control is other than Heat/Cool PID control, set to RO (Read only data).	TC/RTD: 30 V/I: 30.0
51	Integral time [cool-side]	0032	50	R/W	0 to 3600 seconds or 0.0 to 1999.9 seconds (0, 0.0: PD action) * Varies with the setting of the Integral/ Derivative time decimal point position selection. If control is other than Heat/Cool PID control, set to RO (Read only data).	240
52	Derivative time [cool-side]	0033	51	R/W	0 to 3600 seconds or 0.0 to 1999.9 seconds (0, 0.0: PI action) Varies with the setting of the Integral/ Derivative time decimal point position selection. If control is other than Heat/Cool PID control, set to RO (Read only data).	60
53	Overlap/Deadband	0034	52	R/W	TC/RTD inputs: -Input span to +Input span (Unit: °C [°F]) Voltage (V)/Current (I) inputs: -100.0 to +100.0 % of input span Minus (-) setting results in Overlap. However, the overlapping range is within the proportional range. If control is other than Heat/Cool PID control, set to RO (Read only data).	0
54	Manual reset	0035	53	R/W	-100.0 to +100.0 % The offset can be manually eliminated. If the integral function is valid, set to RO (Read only data).	0.0

* When the heat-side or cool-side integral time is set to zero for Heat/Cool PID control, PD action will take place for both heat-side and cool-side.

Continued on the next page.

Continued from the previous page.

No.	Name	Communication item address (Modbus register address)		Attribute	Data range	Factory set value
		HEX	DEC			
55	Setting change rate limiter (up)	0036	54	R/W	0 to Input span/unit time * (0: Unused)	0
56	Setting change rate limiter (down)	0037	55	R/W	* Unit time: 60 seconds (factory set value)	0
57	Area soak time	0038	56	R/W	0 to 11999 seconds or 0 to 5999 minutes Data range of Area soak time can be selected on the Soak time unit. [FB100] When the Digital input (DI) assignment (No. 95) value is 6 to 12, this data becomes RO (Read only data).	0
58	Link area number	0039	57	R/W	0 to 8 (0: No link) [FB100] When the Digital input (DI) assignment (No. 95) value is 6 to 12, this data becomes RO (Read only data).	0
59	Heater break alarm 1 (HBA1) set value	003A	58	R/W	When CT is CTL-6-P-N: 0.0 to 30.0 A (0.0: Not used) When CT is CTL-12-S56-10L-N: 0.0 to 100.0 A (0.0: Not used) If there is no Current transformer 1 (CT1) or CT1 is assigned to "0: None," set to RO (Read only data).	0.0
60	Heater break determination point 1	003B	59	R/W	0.0 to 100.0 % of HBA1 set value (0.0: Heater break determination is invalid) If there is no Current transformer 1 (CT1) or CT1 is assigned to "0: None," set to RO (Read only data). If Heater break alarm 1 (HBA1) corresponds to "0: Type A," set to RO (Read only data).	30.0
61	Heater melting determination point 1	003C	60	R/W	0.0 to 100.0 % of HBA1 set value (0.0: Heater melting determination is invalid) If there is no Current transformer 1 (CT1) or CT1 is assigned to "0: None," set to RO (Read only data). If Heater break alarm 1 (HBA1) corresponds to "0: Type A," set to RO (Read only data).	30.0
62	Heater break alarm 2 (HBA2) set value	003D	61	R/W	When CT is CTL-6-P-N: 0.0 to 30.0 A (0.0: Not used) When CT is CTL-12-S56-10L-N: 0.0 to 100.0 A (0.0: Not used) If there is no Current transformer 2 (CT2) or CT2 is assigned to "0: None," set to RO (Read only data).	0.0

Continued on the next page.

Continued from the previous page.

No.	Name	Communication item address (Modbus register address)		Attribute	Data range	Factory set value
		HEX	DEC			
63	Heater break determination point 2	003E	62	R/W	0.0 to 100.0 % of HBA2 set value (0.0: Heater break determination is invalid) If there is no Current transformer 2 (CT2) or CT2 is assigned to "0: None," set to RO (Read only data). If Heater break alarm 2 (HBA2) corresponds to "0: Type A," set to RO (Read only data).	30.0
64	Heater melting determination point 2	003F	63	R/W	0.0 to 100.0 % of HBA2 set value (0.0: Heater melting determination is invalid) If there is no Current transformer 2 (CT2) or CT2 is assigned to "0: None," set to RO (Read only data). If Heater break alarm 2 (HBA2) corresponds to "0: Type A," set to RO (Read only data).	30.0
65	PV bias	0040	64	R/W	-Input span to +Input span	0
66	PV digital filter	0041	65	R/W	0.0 to 100.0 seconds (0.0: Unused)	0.0
67	PV ratio	0042	66	R/W	0.500 to 1.500	1.000
68	PV low input cut-off	0043	67	R/W	0.00 to 25.00 % of input span If the Input square root extraction corresponds to "0: Unused," set to RO (Read only data).	0.00
69	RS bias Cascade control: Cascade bias Ratio setting: Ratio setting bias	0044	68	R/W	-Input span to +Input span [FB100] When the Remote setting (RS) input is not provided, this data becomes RO (Read only data).	0
70	RS digital filter Cascade control: Cascade digital filter Ratio setting: Ratio setting digital filter	0045	69	R/W	0.0 to 100.0 seconds (0.0: Unused) [FB100] When the Remote setting (RS) input is not provided, this data becomes RO (Read only data).	0.0
71	RS ratio Cascade control: Cascade ratio Ratio setting: Ratio setting ratio	0046	70	R/W	0.001 to 9.999 [FB100] When the Remote setting (RS) input is not provided, this data becomes RO (Read only data).	1.000

Continued on the next page.

Continued from the previous page.

No.	Name	Communication item address (Modbus register address)		Attribute	Data range	Factory set value
		HEX	DEC			
72	Proportional cycle time [heat-side]	0047	71	R/W	0.1 to 100.0 seconds This item becomes RO (Read only data) for the Voltage/Current output specification.	Relay contact output: 20.0 Voltage pulse output, Triac output and Open collector output: 2.0
73	Proportional cycle time [cool-side]	0048	72	R/W	0.1 to 100.0 seconds If control is other than Heat/Cool PID control, set to RO (Read only data). This item becomes RO (Read only data) for the Voltage/Current output specification.	Relay contact output: 20.0 Voltage pulse output, Triac output and Open collector output: 2.0
74	Manual manipulated output value	0049	73	R/W	PID control: Output limiter low [MV1] to Output limiter high [MV1] Heat/Cool PID control: -Output limiter high [MV2] to +Output limiter high [MV1] (-105.0 to +105.0 %) Position proportioning control with feedback resistance (FBR) input: Output limiter low [MV1] to Output limiter high [MV1]	0.0
75	Set lock level	004A	74	R/W	Bit data Bit 0: Lock only setting items other than SV and Event set value (EV1 to EV4). Bit 1: Lock only Event set value (EV1 to EV4) Bit 2: Lock only set value (SV) Bit 3 to Bit 15: Unused Data 0: Unlock 1: Lock [Decimal number: 0 to 7]	0
76	STOP display	004B	75	R/W	0: "SfOP" is displayed on the PV display. 1: "SfOP" is displayed on the SV display.	1

Continued on the next page.

Continued from the previous page.

No.	Name	Communication item address (Modbus register address)		Attribute	Data range	Factory set value
		HEX	DEC			
77	Bar graph display	004C	76	R/W	0: No display 1: Manipulated output value (MV) 2: Measured value (PV) 3: Set value (SV) monitor 4: Deviation value 5: Current transformer 1 (CT1) input value 6: Current transformer 2 (CT2) input value	1
78	Bar graph display resolution	004D	77	R/W	1 to 100 digit/dot Becomes valid when the Bar graph display is "4: Deviation value," "5: Current transformer 1 (CT1) input value" or "6: Current transformer 2 (CT2) input value."	100
79	Direct key 1 [FB100] Direct key selection	004E	78	R/W	[FB100] 0: Unused 1: Used [FB400/FB900] 0: Unused 1: A/M transfer key (Type 1, Type 2)	1
80	Direct key 2 ♦	004F	79	R/W	0: Unused 1: MONI key (For type 1) or R/L transfer key (For type 2)	1
81	Direct key 3 ♦	0050	80	R/W	0: Unused 1: AREA key (For type 1) or RUN/STOP transfer key (For type 2)	1
82	Direct key type	0051	81	R/W	[FB100] 1: Auto/Manual transfer 2: Monitor 3: Memory area transfer 4: Remote/Local transfer 5: RUN/STOP transfer [FB400/900] 1: Type 1 2: Type 2	1

♦ Unused on the FB100.

Continued on the next page.

Continued from the previous page.

No.	Name	Communication item address (Modbus register address)		Attribute	Data range	Factory set value
		HEX	DEC			
83	Input type	0052	82	R/W	0: TC input K 1: TC input J 2: TC input R 3: TC input S 4: TC input B 5: TC input E 6: TC input N 7: TC input T 8: TC input W5Re/W26Re 9: TC input PLII 10: TC input U 11: TC input L 12: RTD input Pt100 13: RTD input JPt100 14: Current input 0 to 20 mA DC 15: Current input 4 to 20 mA DC 16: Voltage (high) input 0 to 10 V DC 17: Voltage (high) input 0 to 5 V DC 18: Voltage (high) input 1 to 5 V DC 19: Voltage (low) input 0 to 1 V DC 20: Voltage (low) input 0 to 100 mV DC 21: Voltage (low) input 0 to 10 mV DC 24: Voltage (high) input ± 1 V DC 25: Voltage (low) input ± 100 mV DC 26: Voltage (low) input ± 10 mV DC If changed to Voltage (high) input from TC/RTD/Current/Voltage (low) input, select the hardware by the input selector switch (for measurement input) at the side of the instrument. For the selecting procedure, refer to FB100 Instruction Manual (IMR01W16-E□) or FB400/FB900 Instruction Manual (IMR01W03-E□) .	Depends on model code. When not specifying: 0
84	Display unit	0053	83	R/W	0: °C 1: °F Use to select the temperature unit for thermocouple (TC) and RTD inputs.	0

Continued on the next page.

Continued from the previous page.

No.	Name	Communication item address (Modbus register address)		Attribute	Data range	Factory set value
		HEX	DEC			
85	Decimal point position	0054	84	R/W	0: No decimal place 1: One decimal place 2: Two decimal places 3: Three decimal places 4: Four decimal places TC input: K, J, E: Only 0 or 1 can be set. T, U, L: Only 1 can be set. Other than the above: Only 0 can be set. RTD input: From 0 to 2 can be set. V/I inputs: From 0 to 4 can be set.	Depends on model code. When not specifying: TC/RTD: 0 V/I: 1
86	Input scale high	0055	85	R/W	TC/RTD inputs: Input scale low to Maximum value of the selected input range Voltage (V)/Current (I) inputs: -19999 to +19999 (Varies with the setting of the Decimal point position)	TC/RTD: Maximum value of the selected input range V/I: 100.0
87	Input scale low	0056	86	R/W	TC/RTD inputs: Minimum value of the selected input range to Input scale high Voltage (V)/Current (I) inputs: -19999 to +19999 (Varies with the setting of the Decimal point position)	TC/RTD: Minimum value of the selected input range V/I: 0.0
88	Input error determination point (high)	0057	87	R/W	Input scale low - (5 % of input span) to Input scale high + (5 % of input span)	TC/RTD: Input scale high + (5 % of input span) V/I: 105.0
89	Input error determination point (low)	0058	88	R/W		TC/RTD: Input scale low - (5 % of input span) V/I: -5.0
90	Burnout direction	0059	89	R/W	0: Upscale 1: Downscale Valid only when the TC input and Voltage (low) input are selected.	0
91	Square root extraction	005A	90	R/W	0: Unused 1: Used	0

Continued on the next page.

Continued from the previous page.

No.	Name	Communication item address (Modbus register address)		Attribute	Data range	Factory set value
		HEX	DEC			
92	Power supply frequency	005B	91	R/W	0: 50 Hz 1: 60 Hz If power frequency measurement was made possible with CT input and/or Power feed forward (PFF) input applied, set to RO (Read only data).	0
93	Sampling cycle	005C	92	R/W	0: 50 ms 1: 100 ms 2: 250 ms	1
94	Remote setting input type	005D	93	R/W	14: Current input 0 to 20 mA DC 15: Current input 4 to 20 mA DC 16: Voltage (high) input 0 to 10 V DC 17: Voltage (high) input 0 to 5 V DC 18: Voltage (high) input 1 to 5 V DC 19: Voltage (low) input 0 to 1 V DC 20: Voltage (low) input 0 to 100 mV DC 21: Voltage (low) input 0 to 10 mV DC If changed to Voltage (high) input from Current/Voltage (low) input, select the hardware by the input selector switch [for remote setting (SR) input] at the side of the instrument. For the selecting procedure, FB100 Instruction Manual (IMR01W16-E□) or FB400/FB900 Instruction Manual (IMR01W03-E□) .	Depends on model code. When not specifying: 15
95	Digital input (DI) assignment	005E	94	R/W	[FB100] 1 to 26 [FB400/900] 1 to 8 Refer to Table 1 “Digital input (DI) assignment” (P. 50) .	Depends on model code. When not specifying: 1
96	Output assignment	005F	95	R/W	[FB100] 1 to 15 [FB400/900] 1 to 7 Refer to Table 2 “Output assignment” (P. 51) .	Depends on model code. When not specifying: FB100: 1 FB400/900: 2
97	Timer 1	0060	96	R/W	0.0 to 600.0 seconds Customization tool is necessary when the timer function is availed.	0.0
98	Timer 2	0061	97	R/W		0.0
99	Timer 3	0062	98	R/W		0.0
100	Timer 4	0063	99	R/W		0.0

Continued on the next page.

Continued from the previous page.

No.	Name	Communication item address (Modbus register address)		Attribute	Data range	Factory set value
		HEX	DEC			
101	Energized/De-energized	0064	100	R/W	Bit data Bit 0: DO1 Bit 1: DO2 Bit 2: DO3 * Bit 3: DO4 * Bit 4 to Bit 15: Unused Data 0: Energized 1: De-energized [Decimal number: 0 to 15] * Unused on the FB100.	0
102	Alarm (ALM) lamp lighting condition 1 ^a	0065	101	R/W	Bit data Bit 0: Event 1 Bit 1: Event 2 Bit 2: Event 3 Bit 3: Event 4 Bit 4 to Bit 15: Unused Data 0: ALM lamp is not lit 1: ALM lamp is lit [Decimal number: 0 to 15]	1111 (Bit image)
103	Alarm (ALM) lamp lighting condition 2 ^a	0066	102	R/W	Bit data Bit 0: HBA1 Bit 1: HBA2 Bit 2 to Bit 15: Unused Data 0: ALM lamp is not lit 1: ALM lamp is lit [Decimal number: 0 to 3]	11 (Bit image)
104	Output status at STOP mode	0067	103	R/W	Bit data Bit 0: Event function Bit 1: Transmission output Bit 2 to Bit 15: Unused Data 0: OFF 1: Action continued [Decimal number: 0 to 3]	0
105 ⋮ 110	Unused	0068 ⋮ 006D	104 ⋮ 109	—	—	—
111	Transmission output type	006E	110	R/W	0: None 1: Measured value (PV) 2: Set value (SV) monitor 3: Deviation value 4: Manipulated output value (MV1)[heat-side] 5: Manipulated output value (MV2) [cool-side] 6: Set value (SV) 7: Remote setting (RS) input value	1

^a When two or more items are set to “1: ALM lamp is lit,” if an error occurs in any one of these item, the alarm lamp on the front of the controller (FB100/400/900) lights.

Continued on the next page.

Continued from the previous page.

No.	Name	Communication item address (Modbus register address)		Attribute	Data range	Factory set value
		HEX	DEC			
112	Transmission output scale high	006F	111	R/W	When the PV, SV, SV monitor and RS: Input scale low to Input scale high When the MV1 and MV2: -5.0 to +105.0 % When the deviation value: -Input span to +Input span	PV/SV/RS: Input scale high MV1/MV2: 100.0 Deviation: +Input span
113	Transmission output scale low	0070	112	R/W		PV/SV/RS: Input scale low MV1/MV2: 0.0 Deviation: -Input span
114	Event 1 type	0071	113	R/W	0: None 1: Deviation high ¹ 2: Deviation low ¹ 3: Deviation high/low ¹ 4: Band ¹ 5: Process high ¹ 6: Process low ¹ 7: SV high 8: SV low 9: Unused 10: MV1 high [heat-side] ^{1, 2} 11: MV1 low [heat-side] ^{1, 2} 12: MV2 high [cool-side] ¹ 13: MV2 low [cool-side] ¹ ¹ Event hold action is available. ² If there is Feedback resistance (FBR) input in Position proportioning control, set to the Feedback resistance (FBR) input value.	Depends on model code. When not specifying: 0
115	Event 1 hold action	0072	114	R/W	0: OFF 1: Hold action ON (when power turned on; when transferred from STOP to RUN) 2: Re-hold action ON (when power turned on; when transferred from STOP to RUN; SV changed)	Depends on model code. When not specifying: 0
116	Event 1 interlock	0073	115	R/W	0: Unused 1: Used	0
117	Event 1 differential gap	0074	116	R/W	① Deviation, process or set value: 0 to Input span (Unit: °C [°F]) ② MV: 0.0 to 110.0 %	①: TC/RTD: 2 V/I: 0.2 ②: 0.2

Continued on the next page.

Continued from the previous page.

No.	Name	Communication item address (Modbus register address)		Attribute	Data range	Factory set value
		HEX	DEC			
118	Event 1 delay timer	0075	117	R/W	0.0 to 600.0 seconds	0.0
119	Force ON of Event 1 action	0076	118	R/W	Bit data Bit 0: Event output turned on at input error occurrence Bit 1: Event output turned on in Manual mode Bit 2: Event output turned on during the Autotuning (AT) function is being executed Bit 3: Event output turned on during the Setting change rate limiter is being operated Bit 4 to Bit 15: Unused Data 0: Invalid 1: Valid [Decimal number: 0 to 15]	0
120	Event 2 type	0077	119	R/W	0: None 1: Deviation high ¹ 2: Deviation low ¹ 3: Deviation high/low ¹ 4: Band ¹ 5: Process high ¹ 6: Process low ¹ 7: SV high 8: SV low 9: Unused 10: MV1 high [heat-side] ^{1, 2} 11: MV1 low [heat-side] ^{1, 2} 12: MV2 high [cool-side] ¹ 13: MV2 low [cool-side] ¹ ¹ Event hold action is available. ² If there is Feedback resistance (FBR) input in Position proportioning control, set to the Feedback resistance (FBR) input value.	Depends on model code. When not specifying: 0
121	Event 2 hold action	0078	120	R/W	0: OFF 1: Hold action ON (when power turned on; when transferred from STOP to RUN) 2: Re-hold action ON (when power turned on; when transferred from STOP to RUN; SV changed)	Depends on model code. When not specifying: 0
122	Event 2 interlock	0079	121	R/W	0: Unused 1: Used	0

Continued on the next page.

Continued from the previous page.

No.	Name	Communication item address (Modbus register address)		Attribute	Data range	Factory set value
		HEX	DEC			
123	Event 2 differential gap	007A	122	R/W	① Deviation, process or set value: 0 to Input span (Unit: °C [°F]) ② MV: 0.0 to 110.0 %	①: TC/RTD: 2 V/I: 0.2 ②: 0.2
124	Event 2 delay timer	007B	123	R/W	0.0 to 600.0 seconds	0.0
125	Force ON of Event 2 action	007C	124	R/W	Bit data Bit 0: Event output turned on at input error occurrence Bit 1: Event output turned on in Manual mode Bit 2: Event output turned on during the Autotuning (AT) function is being executed Bit 3: Event output turned on during the Setting change rate limiter is being operated Bit 4 to Bit 15: Unused Data 0: Invalid 1: Valid [Decimal number: 0 to 15]	0
126	Event 3 type	007D	125	R/W	0: None 1: Deviation high ¹ 2: Deviation low ¹ 3: Deviation high/low ¹ 4: Band ¹ 5: Process high ¹ 6: Process low ¹ 7: SV high 8: SV low 9: Unused 10: MV1 high [heat-side] ^{1, 2} 11: MV1 low [heat-side] ^{1, 2} 12: MV2 high [cool-side] ¹ 13: MV2 low [cool-side] ¹ ¹ Event hold action is available. ² If there is Feedback resistance (FBR) input in Position proportioning control, set to the Feedback resistance (FBR) input value.	Depends on model code. When not specifying: 0
127	Event 3 hold action	007E	126	R/W	0: OFF 1: Hold action ON (when power turned on; when transferred from STOP to RUN) 2: Re-hold action ON (when power turned on; when transferred from STOP to RUN; SV changed)	Depends on model code. When not specifying: 0
128	Event 3 interlock	007F	127	R/W	0: Unused 1: Used	0

Continued on the next page.

Continued from the previous page.

No.	Name	Communication item address (Modbus register address)		Attribute	Data range	Factory set value
		HEX	DEC			
129	Event 3 differential gap	0080	128	R/W	① Deviation, process or set value: 0 to Input span (Unit: °C [°F]) ② MV: 0.0 to 110.0 %	①: TC/RTD: 2 V/I: 0.2 ②: 0.2
130	Event 3 delay timer	0081	129	R/W	0.0 to 600.0 seconds	0.0
131	Force ON of Event 3 action	0082	130	R/W	Bit data Bit 0: Event output turned on at input error occurrence Bit 1: Event output turned on in Manual mode Bit 2: Event output turned on during the Autotuning (AT) function is being executed Bit 3: Event output turned on during the Setting change rate limiter is being operated Bit 4 to Bit 15: Unused Data 0: Invalid 1: Valid [Decimal number: 0 to 15]	0
132	Event 4 type	0083	131	R/W	0: None 1: Deviation high ¹ 2: Deviation low ¹ 3: Deviation high/low ¹ 4: Band ¹ 5: Process high ¹ 6: Process low ¹ 7: SV high 8: SV low 9: Control loop break alarm (LBA) 10: MV1 high [heat-side] ^{1, 2} 11: MV1 low [heat-side] ^{1, 2} 12: MV2 high [cool-side] ¹ 13: MV2 low [cool-side] ¹ ¹ Event hold action is available. ² If there is Feedback resistance (FBR) input in Position proportioning control, set to the Feedback resistance (FBR) input value.	Depends on model code. When not specifying: 0
133	Event 4 hold action	0084	132	R/W	0: OFF 1: Hold action ON (when power turned on; when transferred from STOP to RUN) 2: Re-hold action ON (when power turned on; when transferred from STOP to RUN; SV changed)	Depends on model code. When not specifying: 0
134	Event 4 interlock	0085	133	R/W	0: Unused 1: Used	0

Continued on the next page.

Continued from the previous page.

No.	Name	Communication item address (Modbus register address)		Attribute	Data range	Factory set value
		HEX	DEC			
135	Event 4 differential gap	0086	134	R/W	① Deviation, process or set value: 0 to Input span (Unit: °C [°F]) ② MV: 0.0 to 110.0 % Becomes invalid when the Event 4 type corresponds to "9: Control loop break alarm (LBA)."	①: TC/RTD: 2 V/I: 0.2 ②: 0.2
136	Event 4 delay timer	0087	135	R/W	0.0 to 600.0 seconds	0.0
137	Force ON of Event 4 action	0088	136	R/W	Bit data Bit 0: Event output turned on at input error occurrence Bit 1: Event output turned on in Manual mode Bit 2: Event output turned on during the Autotuning (AT) function is being executed Bit 3: Event output turned on during the Setting change rate limiter is being operated Bit 4 to Bit 15: Unused Data 0: Invalid 1: Valid [Decimal number: 0 to 15]	0
138	CT1 ratio	0089	137	R/W	0 to 9999	CTL-6-P-N: 800 CTL-12-S56-1 0L-N: 1000
139	CT1 assignment	008A	138	R/W	0: None 1: OUT1 2: OUT2 3: DO1 4: DO2 5: DO3 * 6: DO4 * * Unused on the FB100.	1
140	Heater break alarm 1 (HBA1) type	008B	139	R/W	0: Heater break alarm 1 (HBA1) type A (Time-proportional control output) 1: Heater break alarm 1 (HBA1) type B (Continuous control output and Time-proportional control output)	1
141	Number of Heater break alarm 1 (HBA1) delay times	008C	140	R/W	0 to 255 times	5
142	CT2 ratio	008D	141	R/W	0 to 9999	CTL-6-P-N: 800 CTL-12-S56-1 0L-N: 1000

Continued on the next page.

Continued from the previous page.

No.	Name	Communication item address (Modbus register address)		Attribute	Data range	Factory set value
		HEX	DEC			
143	CT2 assignment	008E	142	R/W	0: None 1: OUT1 2: OUT2 3: DO1 4: DO2 5: DO3 * 6: DO4 * * Unused on the FB100.	0
144	Heater break alarm 2 (HBA2) type	008F	143	R/W	0: Heater break alarm 2 (HBA2) type A (Time-proportional control output) 1: Heater break alarm 2 (HBA2) type B (Continuous control output and Time-proportional control output)	1
145	Number of Heater break alarm 2 (HBA2) delay times	0090	144	R/W	0 to 255 times	5
146	Hot/Cold start	0091	145	R/W	0: Hot start 1 1: Hot start 2 2: Cold start 3: Stop start	0
147	Start determination point	0092	146	R/W	0 to Input span (The unit is the same as input value.) (0: Action depending on the Hot/Cold start selection)	3 % of input span
148	External input type	0093	147	R/W	0: Remote setting input (Remote control) 1: Intercontroller communication Cascade control 2: Intercontroller communication Ratio setting When performing Cascade control or Ratio setting, set the master controller to 0 (Remote control). Set slave controllers to 1 (Cascade control) or 2 (Ratio setting).	0
149	Master channel selection	0094	148	R/W	0 to 31 If the External input type corresponds to "1: Cascade control" or "2: Ratio setting," the setting becomes valid.	0
150	SV tracking	0095	149	R/W	0: Unused 1: Used	1
151	MV transfer function [Action taken when changed to Manual mode from Auto mode]	0096	150	R/W	0: MV1 or MV2 in Auto mode is used. 1: When selected by Digital input (DI): MV1 or MV2 in previous Manual mode is used. When selected by front key: MV1 or MV2 in Auto mode is used. 2: MV1 or MV2 in previous Manual mode is used.	0

Continued on the next page.

Continued from the previous page.

No.	Name	Communication item address (Modbus register address)		Attribute	Data range	Factory set value
		HEX	DEC			
152	Control action	0097	151	R/W	0: Brilliant II PID control (direct action) 1: Brilliant II PID control (reverse action) 2: Brilliant II Heat/Cool PID control [water cooling] 3: Brilliant II Heat/Cool PID control [air cooling] 4: Brilliant II Heat/Cool PID control [Cooling gain linear type] 5: Position proportioning control	Depends on model code. When not specifying: 1
153	Integral/Derivative time decimal point position	0098	152	R/W	0: 1 second setting (No decimal place) 1: 0.1 seconds setting (One decimal place)	0
154	Derivative action	0099	153	R/W	0: Measured value derivative 1: Deviation derivative	0
155	Undershoot suppression factor	009A	154	R/W	0.000 to 1.000	Water cooling: 0.100 Air cooling: 0.250 Cooling gain linear type: 1.000
156	Derivative gain	009B	155	R/W	0.1 to 10.0	6.0
157	ON/OFF action differential gap (upper)	009C	156	R/W	TC/RTD inputs: 0 to Input span (Unit: °C [°F])	TC/RTD: 1 V/I: 0.1
158	ON/OFF action differential gap (lower)	009D	157	R/W	Voltage (V)/Current (I) inputs: 0.0 to 100.0 % of input span	TC/RTD: 1 V/I: 0.1
159	Action (high) at input error	009E	158	R/W	0: Normal control 1: Manipulated output value at input error	0
160	Action (low) at input error	009F	159	R/W		0
161	Manipulated output value at input error	00A0	160	R/W	-105.0 to +105.0 % Actual output values become those restricted by the output limiter. Position proportioning control: If there is no Feedback resistance (FBR) input or the Feedback resistance (FBR) input is disconnected, an action taken when abnormal is in accordance with the value action setting during STOP.	0.0

Continued on the next page.

Continued from the previous page.

No.	Name	Communication item address (Modbus register address)		Attribute	Data range	Factory set value
		HEX	DEC			
162	Manipulated output value (MV1) at STOP mode [heat-side]	00A1	161	R/W	-5.0 to +105.0 % Position proportioning control: Only when there is Feedback resistance (FBR) input and no Feedback resistance (FBR) input is disconnected, the Manipulated output value (MV1) during STOP is output.	-5.0
163	Manipulated output value (MV2) at STOP mode [cool-side]	00A2	162	R/W		-5.0
164	Output change rate limiter (up) [MV1]	00A3	163	R/W	0.0 to 100.0 %/seconds (0.0: OFF)	0.0
165	Output change rate limiter (down) [MV1]	00A4	164	R/W	Becomes invalid when in position proportioning control.	0.0
166	Output limiter high [MV1]	00A5	165	R/W	Output limiter low [MV1] to 105.0 % Position proportioning control: Becomes valid only when there is Feedback resistance (FBR) input and it does not break.	105.0
167	Output limiter low [MV1]	00A6	166	R/W	-5.0 % to Output limiter high [MV1] Position proportioning control: Becomes valid only when there is Feedback resistance (FBR) input and it does not break.	-5.0
168	Output change rate limiter (up) [MV2]	00A7	167	R/W	0.0 to 100.0 %/seconds (0.0: OFF)	0.0
169	Output change rate limiter (down) [MV2]	00A8	168	R/W	Becomes invalid when in Position proportioning control.	0.0
170	Output limiter high [MV2]	00A9	169	R/W	Output limiter low [MV2] to 105.0 %	105.0
171	Output limiter low [MV2]	00AA	170	R/W	-5.0 % to Output limiter high [MV2]	-5.0
172	Power feed forward selection ♦	00AB	171	R/W	0: Unused 1: Used	1
173	Power feed forward gain ♦	00AC	172	R/W	0.01 to 5.00	1.00
174	AT bias	00AD	173	R/W	-Input span to +Input span	0
175	AT cycles	00AE	174	R/W	0: 1.5 cycles 1: 2.0 cycles 2: 2.5 cycles 3: 3.0 cycles	1

♦ Unused on the FB100.

Continued on the next page.

Continued from the previous page.

No.	Name	Communication item address (Modbus register address)		Attribute	Data range	Factory set value
		HEX	DEC			
176	Output value with AT turned on	00AF	175	R/W	Output value with AT turned off to +105.0 % Actual output values become those restricted by the output limiter. Position proportioning control: Becomes valid only when there is Feedback resistance (FBR) input and it does not break (high limit of Feedback resistance input at AT).	105.0
177	Output value with AT turned off	00B0	176	R/W	-105.0 % to Output value with AT turned on Actual output values become those restricted by the output limiter. Position proportioning control: Becomes valid only when there is Feedback resistance (FBR) input and it does not break (low limit of Feedback resistance input at AT).	-105.0
178	AT differential gap time	00B1	177	R/W	0.0 to 50.0 seconds	10.0
179	Proportional band adjusting factor [heat-side]	00B2	178	R/W	0.01 to 10.00 times	1.00
180	Integral time adjusting factor [heat-side]	00B3	179	R/W		1.00
181	Derivative time adjusting factor [heat-side]	00B4	180	R/W		1.00
182	Proportional band adjusting factor [cool-side]	00B5	181	R/W		1.00
183	Integral time adjusting factor [cool-side]	00B6	182	R/W		1.00
184	Derivative time adjusting factor [cool-side]	00B7	183	R/W		1.00
185	Proportional band limiter high [heat-side]	00B8	184	R/W	TC/RTD inputs: 0 (0.0, 0.00) to Input span (Unit: °C [°F]) Varies with the setting of the Decimal point position selection. Voltage (V)/Current (I) inputs: 0.0 to 1000.0 % of input span	TC/RTD: Input span V/I: 1000.0
186	Proportional band limiter low [heat-side]	00B9	185	R/W		TC/RTD: 0 V/I: 0.0
187	Integral time limiter high [heat-side]	00BA	186	R/W	0 to 3600 seconds or 0.0 to 1999.9 seconds Varies with the setting of the Integral/Derivative time decimal point position selection.	3600
188	Integral time limiter low [heat-side]	00BB	187	R/W		0

Continued on the next page.

Continued from the previous page.

No.	Name	Communication item address (Modbus register address)		Attribute	Data range	Factory set value
		HEX	DEC			
189	Derivative time limiter high [heat-side]	00BC	188	R/W	0 to 3600 seconds or 0.0 to 1999.9 seconds Varies with the setting of the Integral/Derivative time decimal point position selection.	3600
190	Derivative time limiter low [heat-side]	00BD	189	R/W		0
191	Proportional band limiter high [cool-side]	00BE	190	R/W	TC/RTD inputs: 1 (0.1, 0.01) to input span (Unit: °C [°F]) Varies with the setting of the Decimal point position selection. Voltage (V)/Current (I) inputs: 0.1 to 1000.0 % of input span	TC/RTD: Input span V/I: 1000.0
192	Proportional band limiter low [cool-side]	00BF	191	R/W		TC/RTD: 1 V/I: 0.1
193	Integral time limiter high [cool-side]	00C0	192	R/W	0 to 3600 seconds or 0.0 to 1999.9 seconds Varies with the setting of the Integral/Derivative time decimal point position selection.	3600
194	Integral time limiter low [cool-side]	00C1	193	R/W		0
195	Derivative time limiter high [cool-side]	00C2	194	R/W	0 to 3600 seconds or 0.0 to 1999.9 seconds Varies with the setting of the Integral/Derivative time decimal point position selection.	3600
196	Derivative time limiter low [cool-side]	00C3	195	R/W		0
197	Open/Close output neutral zone	00C4	196	R/W	0.1 to 10.0 % of output	2.0
198	Open/Close output differential gap	00C5	197	R/W	0.1 to 5.0 % of output	1.0
199	Action at Feedback resistance (FBR) input break	00C6	198	R/W	0: Action depending on the valve action at STOP 1: Control action continued	0
200	Feedback adjustment	00C7	199	R/W	0: Adjustment end 1: During adjustment on the open-side 2: During adjustment on the close-side	—
201	Control motor time	00C8	200	R/W	5 to 1000 seconds	10
202	Integrated output limiter	00C9	201	R/W	0.0 to 200.0 % of control motor time (0.0: OFF) Becomes invalid when there is Feedback resistance (FBR) input.	150.0
203	Valve action at STOP	00CA	202	R/W	0: Close-side output OFF, Open-side output OFF 1: Close-side output ON, Open-side output OFF 2: Close-side output OFF, Open-side output ON Becomes valid when there is no Feedback resistance (FBR) input or the Feedback resistance (FBR) input is disconnected.	0

Continued on the next page.

7. COMMUNICATION DATA MAP

Continued from the previous page.

No.	Name	Communication item address (Modbus register address)		Attribute	Data range	Factory set value
		HEX	DEC			
204	Startup tuning (ST)	00CB	203	R/W	0: Startup tuning (ST) unused 1: Execute once * 2: Execute always * When the startup tuning is finished, the setting will automatically returns to "0: ST unused." The Startup tuning (ST) function is activated according to the ST start condition selected. If control is other than Position proportioning control, set to RO (Read only data).	0
205	ST proportional band adjusting factor	00CC	204	R/W	0.01 to 10.00 times	1.00
206	ST integral time adjusting factor	00CD	205	R/W		1.00
207	ST derivative time adjusting factor	00CE	206	R/W		1.00
208	ST start condition	00CF	207	R/W	0: Activate the Startup tuning (ST) function when the power is turned on; when transferred from STOP to RUN; or when the set value (SV) is changed. 1: Activate the Startup tuning (ST) function when the power is turned on; or when transferred from STOP to RUN. 2: Activate the Startup tuning (ST) function when the Set value (SV) is changed.	0
209	Automatic temperature rise group	00D0	208	R/W	0 to 16 (0: Automatic temperature rise function OFF)	0
210	Automatic temperature rise learning	00D1	209	R/W	0: Unused 1: Learning * * When the Automatic temperature rise learning is finished, the setting will automatically returns to "0: Unused." If the Automatic temperature rise group corresponds to "0: Automatic temperature rise function OFF," set to RO (Read only data).	1
211	Automatic temperature rise dead time	00D2	210	R/W	0.1 to 1999.9 seconds	10.0
212	Automatic temperature rise gradient data	00D3	211	R/W	0.1 to Input span/minutes	1.0
213	RUN/STOP group	00D4	212	R/W	0 to 16 (0: Group RUN/STOP function OFF)	0
214	Setting change rate limiter unit time	00D5	213	R/W	1 to 3600 seconds	60

Continued on the next page.

Continued from the previous page.

No.	Name	Communication item address (Modbus register address)		Attribute	Data range	Factory set value
		HEX	DEC			
215	Soak time unit	00D6	214	R/W	0: 0 to 5999 minutes 1: 0 to 11999 seconds Set the data range of Memory area soak time monitor and Area soak time.	1
216	Setting limiter high	00D7	215	R/W	Setting limiter low to Input scale high	Input scale high
217	Setting limiter low	00D8	216	R/W	Input scale low to Setting limiter high	Input scale low
218	PV transfer function	00D9	217	R/W	0: Unused 1: Used	0
219	PV flashing display at input error	00DA	218	R/W	Bit data Bit 0: Input error Bit 1 to Bit 15: Unused Data 0: Flashing display 1: Non-flashing display [Decimal number: 0 to 1]	0
220 ⋮ 224	Unused	00DB ⋮ 00DF	219 ⋮ 223	—	—	—

Table 1: Digital input (DI) assignment

[FB100]

Set value	DI 1	DI 2	DI 3	DI 4	DI 5
1	Unused	Unused	Unused	Unused	Unused
2	Memory area number selection (1 to 8)			Memory area set	RUN/STOP
3	Memory area number selection (1 to 8)			Memory area set	Unused
4	Memory area number selection (1 to 8)			Memory area set	AUTO/MAN
5	Memory area number selection (1 to 8)			Memory area set	Interlock release
6	Memory area number selection (1 to 8)			RUN/STOP	Unused
7	Memory area number selection (1 to 8)			RUN/STOP	AUTO/MAN
8	Memory area number selection (1 to 8)			RUN/STOP	Interlock release
9	Memory area number selection (1 to 8)			Unused	AUTO/MAN
10	Memory area number selection (1 to 8)			Unused	Interlock release
11	Memory area number selection (1 to 8)			AUTO/MAN	Interlock release
12	Memory area number selection (1 to 8)				
13	RUN/STOP	REM/LOC *	AUTO/MAN		
14	RUN/STOP	REM/LOC *	Interlock release		
15	RUN/STOP	AUTO/MAN	Interlock release		
16	REM/LOC *	AUTO/MAN	Interlock release		
17	RUN/STOP	REM/LOC *			
18	RUN/STOP	AUTO/MAN			
19	RUN/STOP	Interlock release			
20	REM/LOC *	AUTO/MAN			
21	REM/LOC *	Interlock release			
22	AUTO/MAN	Interlock release			
23	RUN/STOP				
24	REM/LOC *				
25	AUTO/MAN				
26	Interlock release				

RUN/STOP: RUN/STOP transfer AUTO/MAN: Auto/Manual transfer REM/LOC: Remote/Local transfer

* When the optional function A, C or D is selected, the Remote/Local transfer is invalid.

[FB400/900]

Set value	DI 1	DI 2	DI 3	DI 4	DI 5	DI 6	DI 7
1	Memory area number selection (1 to 8)			Memory area set	Unused		
2					RUN/STOP	REM/LOC	AUTO/MAN
3					RUN/STOP	REM/LOC	Interlock release
4					RUN/STOP	AUTO/MAN	Interlock release
5					REM/LOC	AUTO/MAN	Interlock release
6					RUN/STOP	Unused	Interlock release
7					REM/LOC	Unused	Interlock release
8					AUTO/MAN	Unused	Interlock release

RUN/STOP: RUN/STOP transfer AUTO/MAN: Auto/Manual transfer REM/LOC: Remote/Local transfer

Table 2: Output assignment

[FB100]

Set value	Output 1 (OUT1)	Output 2 (OUT2)	Digital output 1 (DO1)	Digital output 2 (DO2)
1	Control output 1	Control output 2	Event 1 (EV1)	Event 2 (EV2)
2	Control output 1	Control output 2	Event 1 (EV1)	Event 4 (EV4)
3	Control output 1	Control output 2	Event 1 (EV1)	HBA
4	Control output 1	Control output 2	Event 1 (EV1)	FAIL (De-energized)
5	Control output 1	Control output 2	Event 4 (EV4)	HBA
6	Control output 1	Control output 2	Event 4 (EV4)	FAIL (De-energized)
7	Control output 1	Control output 2	HBA	FAIL (De-energized)
8	Control output 1	HBA	Event 1 (EV1)	Event 2 (EV2)
9	Control output 1	HBA	Event 1 (EV1)	Event 4 (EV4)
10	Control output 1	HBA	Event 1 (EV1)	FAIL (De-energized)
11	Control output 1	HBA	Event 4 (EV4)	FAIL (De-energized)
12	Control output 1	FAIL (De-energized)	Event 1 (EV1)	Event 2 (EV2)
13	Control output 1	FAIL (De-energized)	Event 1 (EV1)	Event 4 (EV4)
14	Control output 1	Event 1 (EV1)	Event 2 (EV2)	Event 3 (EV3)
15	Control output 1	Event 4 (EV4)	Event 1 (EV1)	Event 2 (EV2)

HBA: Heater break alarm (HBA) output

- For Position proportioning control, Output 1 (OUT1) is open-side output and Output 2 (OUT2) is close-side output, regardless of the above selection.
- When Current transformer (CT) input is two-point input, Heater break alarm (HBA) output is *OR* output.
- Energized or De-energized can be selected for the digital outputs (DO1 to DO4). [Factory set value: Energized] However, with the exception of FAIL (de-energized, fixed).
- When using for Heat/Cool control, select one of set values 1 to 7.
- Invalid for a non-existing output/event function.

[FB400/900]

Set value	Output 1 (OUT1)	Output 2 (OUT2)	Digital output 1 (DO1)	Digital output 2 (DO2)	Digital output 3 (DO3)	Digital output 4 (DO4)
1	Control output 1	Control output 2	Event 1 (EV1)	Event 2 (EV2)	Event 3 (EV3)	Event 4 (EV4)
2	Control output 1	Control output 2	Event 1 (EV1)	Event 2 (EV2)	Event 3 (EV3)	HBA1 HBA2
3	Control output 1	Control output 2	Event 1 (EV1)	Event 2 (EV2)	HBA1 HBA2	FAIL (De-energized)
4	Control output 1	Control output 2	Event 1 (EV1)	HBA1 HBA2	Event 3 (EV3)	Event 4 (EV4)
5	Control output 1	HBA1 HBA2	Event 1 (EV1)	Event 2 (EV2)	Event 3 (EV3)	Event 4 (EV4)
6	Control output 1	HBA1 HBA2	Event 1 (EV1)	Event 2 (EV2)	Event 3 (EV3)	FAIL (De-energized)
7	Control output 1	FAIL (De-energized)	Event 1 (EV1)	Event 2 (EV2)	Event 3 (EV3)	Event 4 (EV4)

HBA1: Heater break alarm 1 (HBA1) output

HBA2: Heater break alarm 2 (HBA2) output

- When Current transformer (CT) input is two-point input, Heater break alarm (HBA) output is *OR* output.
- Energized or De-energized can be selected for the digital outputs (DO1 to DO4). [Factory set value: Energized] However, with the exception of FAIL (de-energized, fixed).
- Invalid for a non-existing output/event function.

■ Memory area data

The register addresses, 0500H to 0514H are used for checking and changing each set value belonging to the memory area.

No.	Name	Communication item address (Modbus register address)		Attribute	Data range	Factory set value
		HEX	DEC			
1	Setting memory area number	0500	1280	R/O	1 to 8 Use to select memory area number.	1
2	Event 1 set value (EV1)	0501	1281	R/W	Deviation: –Input span to +Input span Process and set value: Input scale low to Input scale high Manipulated output value (MV1 or MV2): –5.0 to +105.0 % If the Event type corresponds to “0: None,” set to RO (Read only data). If Event 4 corresponds to “9: Control loop break alarm (LBA),” the Event 4 set value becomes RO (Read only data).	50
3	Event 2 set value (EV2)	0502	1282	R/W		50
4	Event 3 set value (EV3)	0503	1283	R/W		50
5	Event 4 set value (EV4)	0504	1284	R/W		50
6	Control loop break alarm (LBA) time	0505	1285	R/W		0 to 7200 seconds (0: Unused) If Event 4 is other than “9: Control loop break alarm (LBA),” set to RO (Read only data).
7	LBA deadband	0506	1286	R/W	0 to Input span If Event 4 is other than “9: Control loop break alarm (LBA),” set to RO (Read only data).	0
8	Set value (SV)	0507	1287	R/W	Setting limiter low to Setting limiter high	TC/RTD: 0 V/I: 0.0
9	Proportional band [heat-side]	0508	1288	R/W	TC/RTD inputs: 0 (0.0, 0.00) to Input span (Unit: °C [°F]) Varies with the setting of the Decimal point position selection. Voltage (V)/Current (I) inputs: 0.0 to 1000.0 % of input span (0, 0.0 or 0.00: ON/OFF action)	TC/RTD: 30 V/I: 30.0
10	Integral time [heat-side]	0509	1289	R/W	PID control or Heat/Cool PID control: 0 to 3600 seconds or 0.0 to 1999.9 seconds (0, 0.0: PD action) * Position proportioning control: 1 to 3600 seconds or 0.1 to 1999.9 seconds Varies with the setting of the Integral/Derivative time decimal point position selection.	240

* When the heat-side or cool-side integral time is set to zero for Heat/Cool PID control, PD action will take place for both heat-side and cool-side.

Continued on the next page.

Continued from the previous page.

No.	Name	Communication item address (Modbus register address)		Attribute	Data range	Factory set value
		HEX	DEC			
11	Derivative time [heat-side]	050A	1290	R/W	0 to 3600 seconds or 0.0 to 1999.9 seconds (0, 0.0: PI action) Varies with the setting of the Integral/Derivative time decimal point position selection.	60
12	Control response parameter	050B	1291	R/W	0: Slow 1: Medium 2: Fast When the P or PD action is selected, this setting becomes invalid.	PID control, Position proportioning control: 0 Heat/Cool PID control: 2
13	Proportional band [cool-side]	050C	1292	R/W	TC/RTD inputs: 1 (0.1, 0.01) to Input span (Unit: °C [°F]) Varies with the setting of the Decimal point position selection. Voltage (V)/Current (I) inputs: 0.1 to 1000.0 % of input span If control is other than Heat/Cool PID control, set to RO (Read only data).	TC/RTD: 30 V/I: 30.0
14	Integral time [cool-side]	050D	1293	R/W	0 to 3600 seconds or 0.0 to 1999.9 seconds (0, 0.0: PD action) * Varies with the setting of the Integral/Derivative time decimal point position selection. If control is other than Heat/Cool PID control, set to RO (Read only data).	240
15	Derivative time [cool-side]	050E	1294	R/W	0 to 3600 seconds or 0.0 to 1999.9 seconds (0, 0.0: PI action) Varies with the setting of the Integral/Derivative time decimal point position selection. If control is other than Heat/Cool PID control, set to RO (Read only data).	60
16	Overlap/Deadband	050F	1295	R/W	TC/RTD inputs: -Input span to +Input span (Unit: °C [°F]) Voltage (V)/Current (I) inputs: -100.0 to +100.0 % of input span Minus (-) setting results in Overlap. However, the overlapping range is within the proportional range. If control is other than Heat/Cool PID control, set to RO (Read only data).	0

* When the heat-side or cool-side integral time is set to zero for Heat/Cool PID control, PD action will take place for both heat-side and cool-side.

Continued on the next page.

7. COMMUNICATION DATA MAP

Continued from the previous page.

No.	Name	Communication item address (Modbus register address)		Attribute	Data range	Factory set value
		HEX	DEC			
17	Manual reset	0510	1296	R/W	-100.0 to +100.0 % The offset can be manually eliminated. If the integral function is valid, set to RO (Read only data).	0.0
18	Setting change rate limiter (up)	0511	1297	R/W	0 to Input span/unit time * (0: Unused)	0
19	Setting change rate limiter (down)	0512	1298	R/W	* Unit time: 60 seconds (factory set value)	0
20	Area soak time	0513	1299	R/W	0 to 11999 seconds or 0 to 5999 minutes Data range of Area soak time can be selected on the Soak time unit. [FB100] When the Digital input (DI) assignment value is 6 to 12, this data becomes RO (Read only data).	0
21	Link area number	0514	1300	R/W	0 to 8 (0: No link) [FB100] When the Digital input (DI) assignment value is 6 to 12, this data becomes RO (Read only data).	0
22	Unused	0515	1301	—	—	—

8. USAGE EXAMPLE

This chapter describes an usage example of PROFIBUS communication when connected with the COM-JG and controller (FB400) with the PLC set to a master.

8.1 Handling Procedures

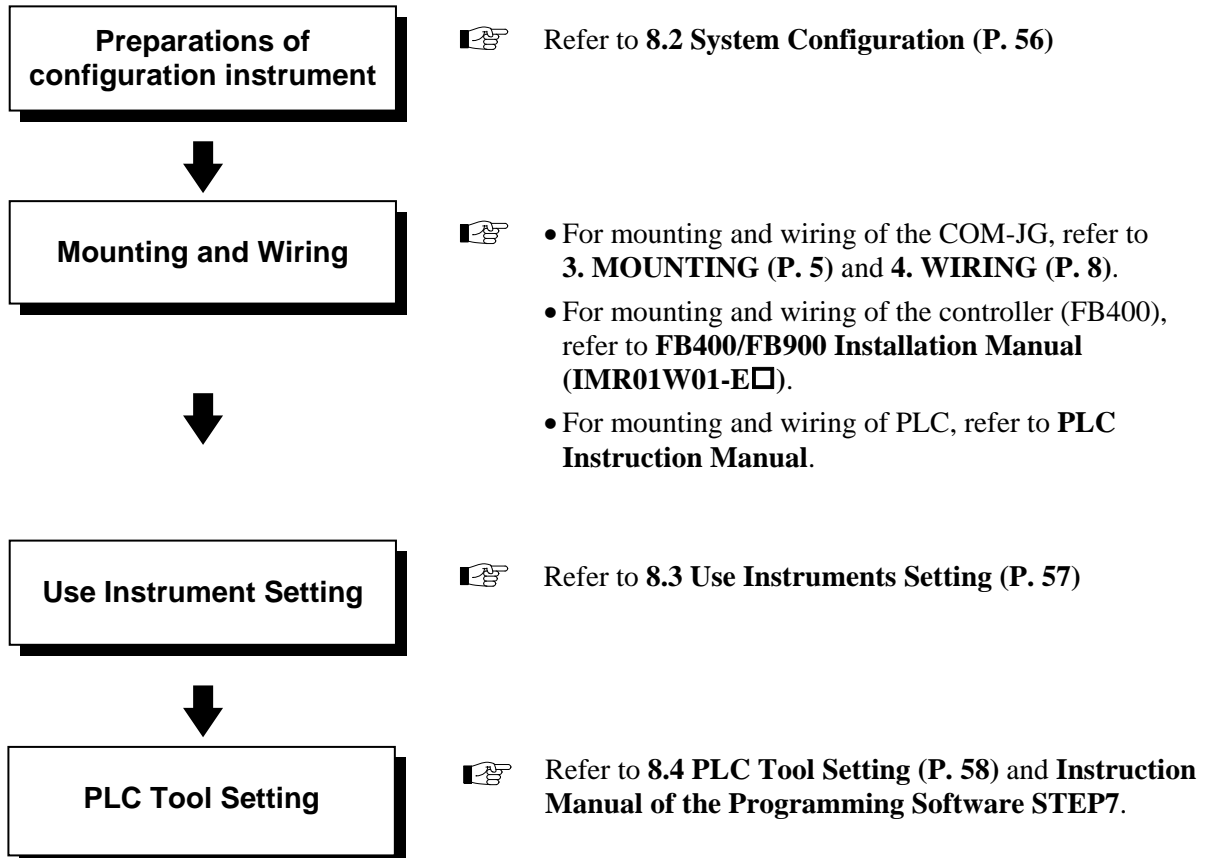

 To avoid error at operation start-up, COM-JG must be powered on **LAST** (after the controller, PLC, etc.).

8.2 System Configuration

In this usage example, described the following system configuration.

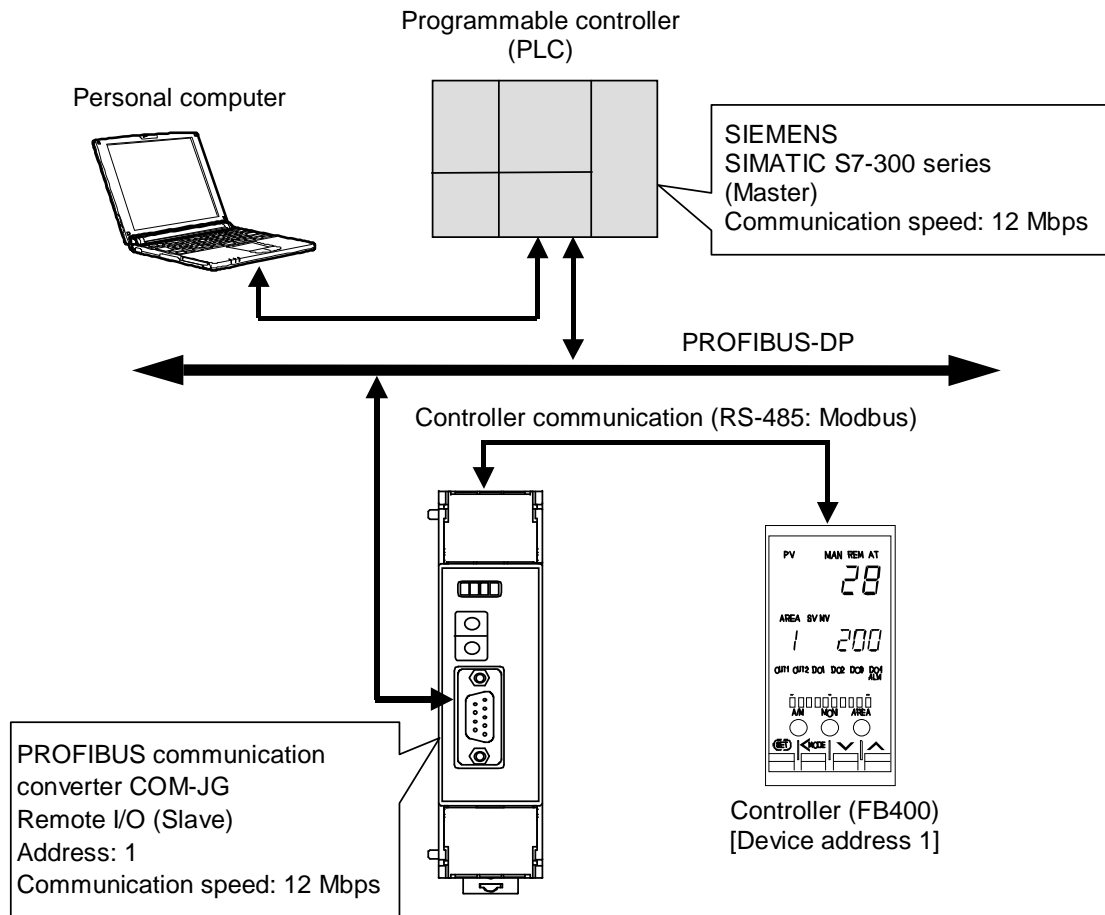

■ Use instruments

- PROFIBUS communication converter: COM-JG 1
- Temperature controller (with communication function): FB400 1
- PLC
SIMATIC S7-300 series (SIEMENS AG)
 - Power supply module: PS-300 (PS307 2A)..... 1
 - CPU module: S7-300 (CPU315-2DP) 1
 - Digital input module: DI-300 (SM321 DI16)..... 1

- Personal computer

Software of the following must be installed in a personal computer.

- Programming Software STEP7 V5.1 (SIEMENS AG)

 For the personal computer to be connected to the PLC, refer to Instruction Manual of PLC and STEP7.

8.3 Use Instruments Setting

Set the PLC, COM-JG and controller as the following.



There is not the hardware setting of PLC: SIMATIC S7-300 series (SIEMENS AG).

■ COM-JG setting

Set COM-JG to the following conditions.

- PROFIBUS address: 1
- Controller communication speed: 19200 bps (Factory set value)
- Controller address setting mode: Continuous setting (Factory set value)



For setting procedure, refer to **5. SETTING (P. 15)**.

■ Controller (FB400) setting

- Device address 1: 1
- Communication protocol: MODBUS-RTU
- Communication speed: 19200 bps (Factory set value)
- Data bit configuration: Data 8-bit, Without parity bit, Stop 1-bit



When it uses more than one controller, a device address set the address that continued from 1.



For setting procedure, refer to **FB400/FB900 Communication Quick Manual (IMR01W07-E□)**.

8.4 PLC Tool Setting

The procedure of using the Programming Software STEP7 is as follows.

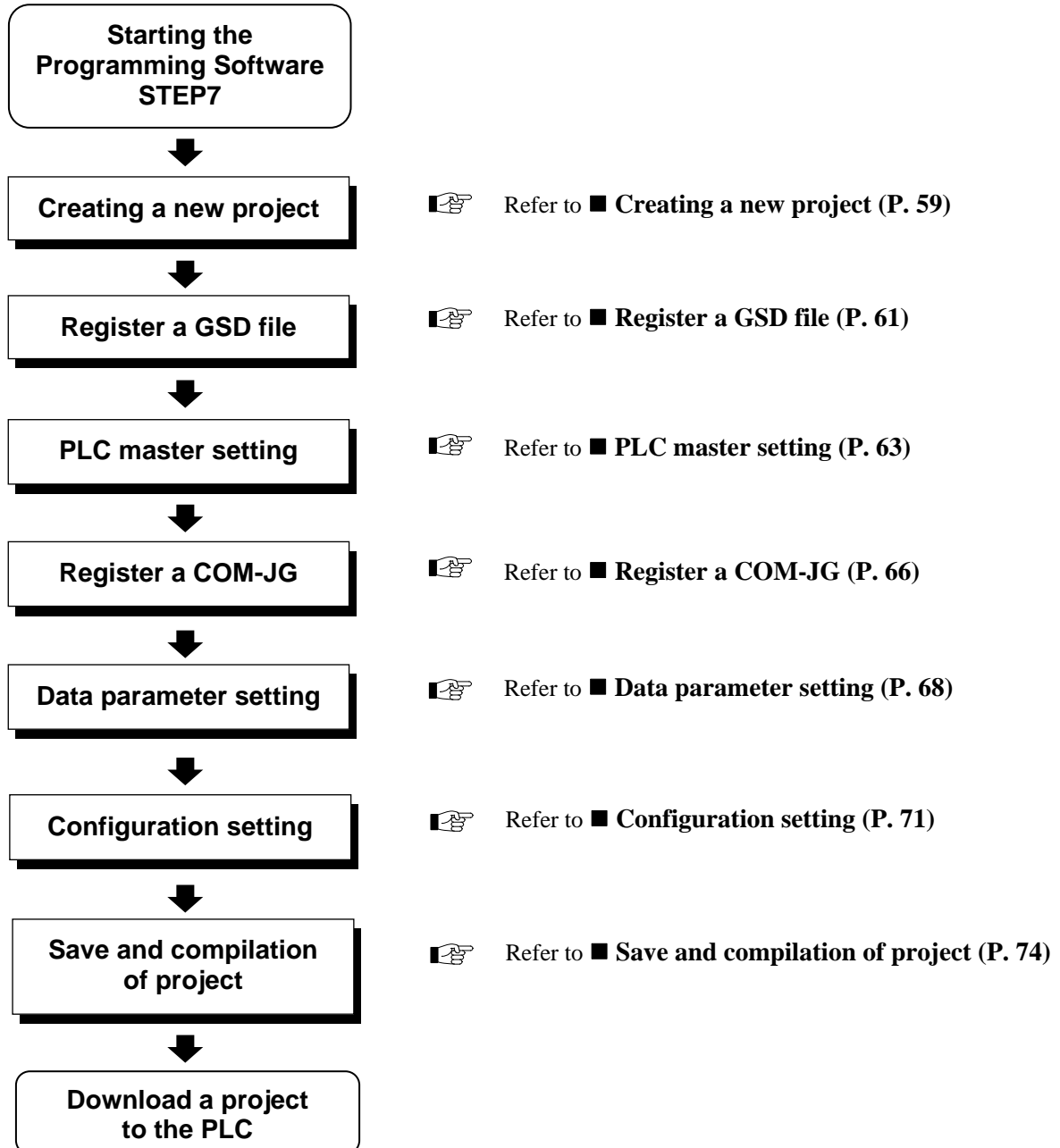

■ For details, refer to Instruction Manual of the Programming Software STEP7.

■ Creating a new project

1. Start programming software STEP7.
2. Select the menu command **File** → **New...**, and creating a new project.
In this example, the project name is “COM-J.”

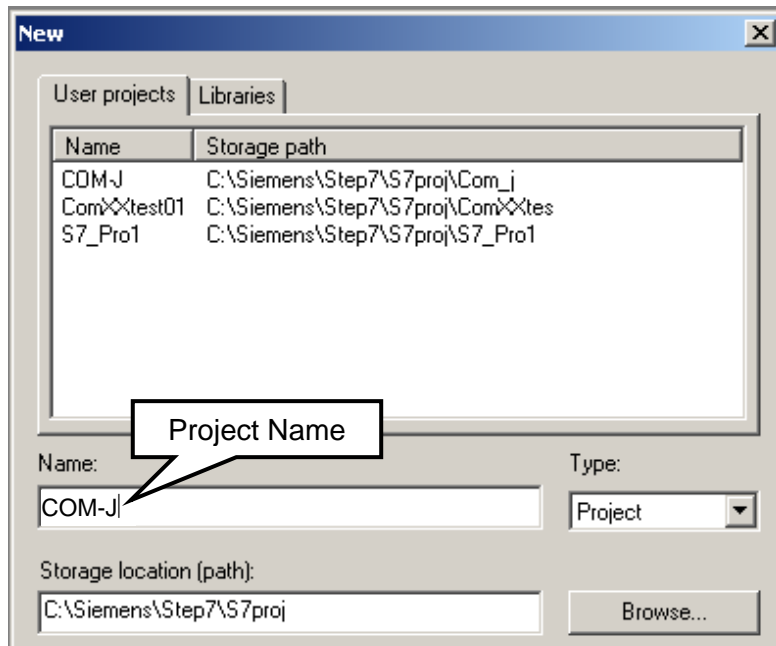

3. Clicking “OK” displays the new project on the SIMATIC Manager.

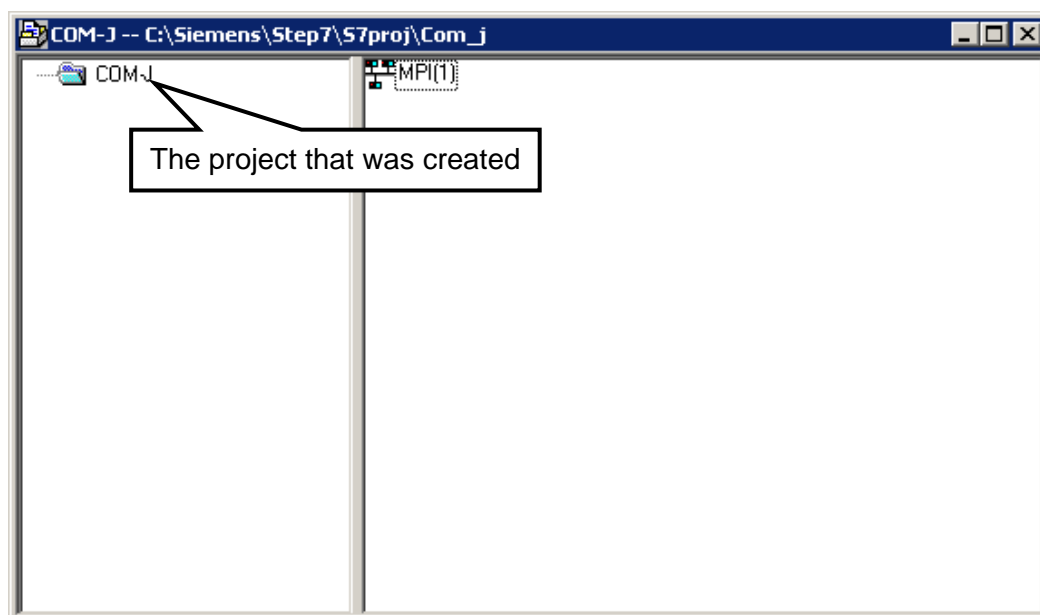

Continued on the next page.

Continued from the previous page.

- 4. The PLC is registered to the created object.
In this example, select “SIMATIC 300 Station.”

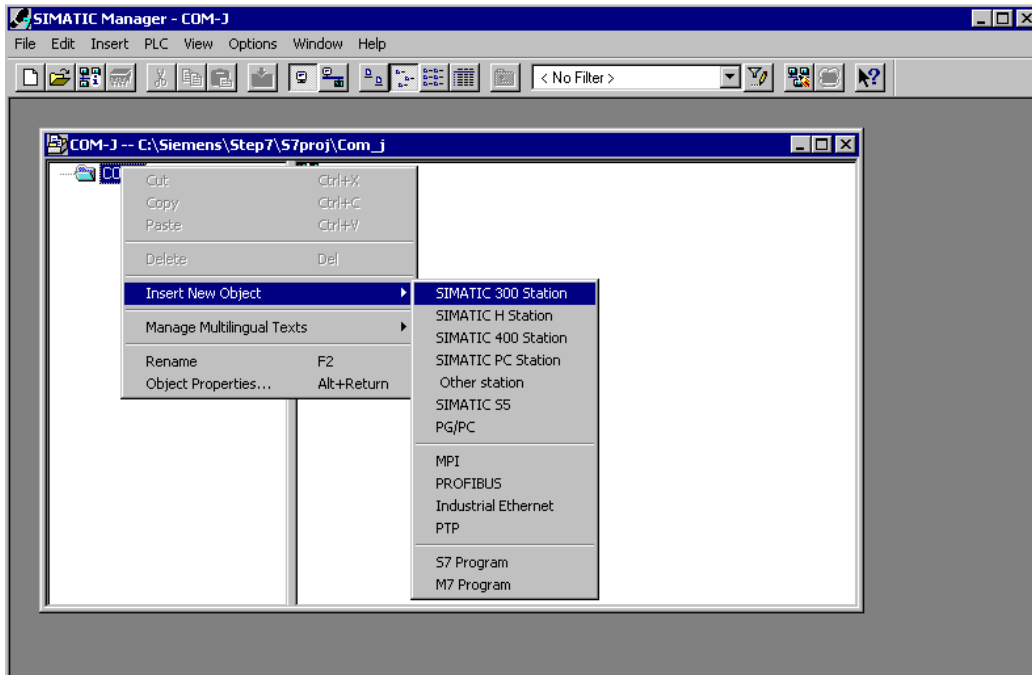

- 5. If the PLC is registered, the display becomes as follows.

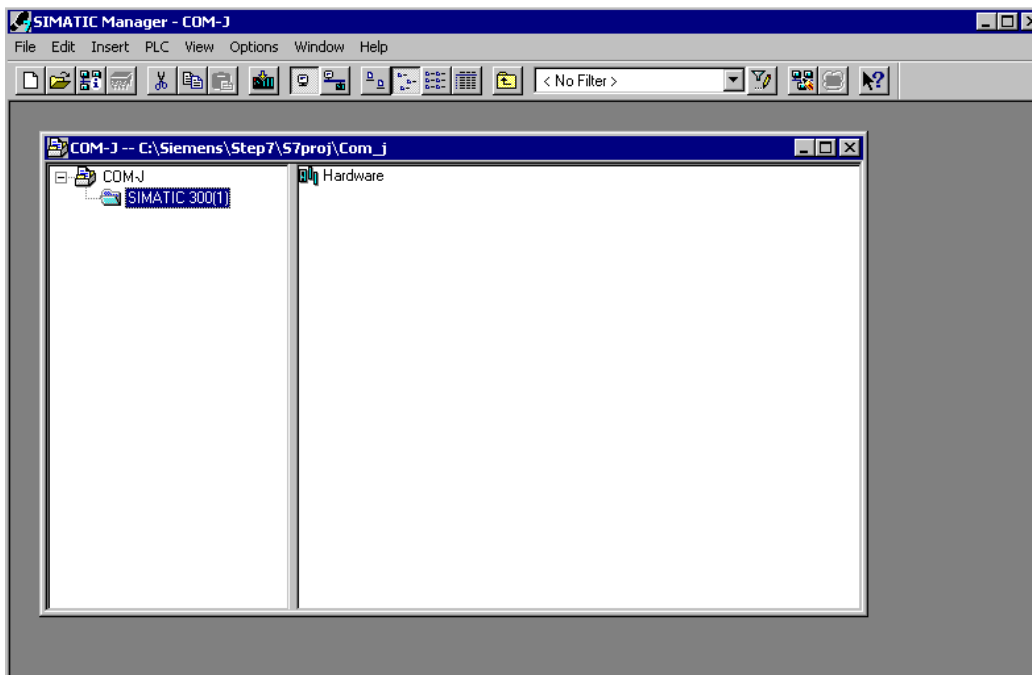

■ Register a GSD file

1. To link COM-JG to the project, register the GSD file for COM-JG downloaded from RKC official website. Click the “SIMATIC 300” folder on the screen registered with the PLC and then double-click “Hardware” on the right side of the window.

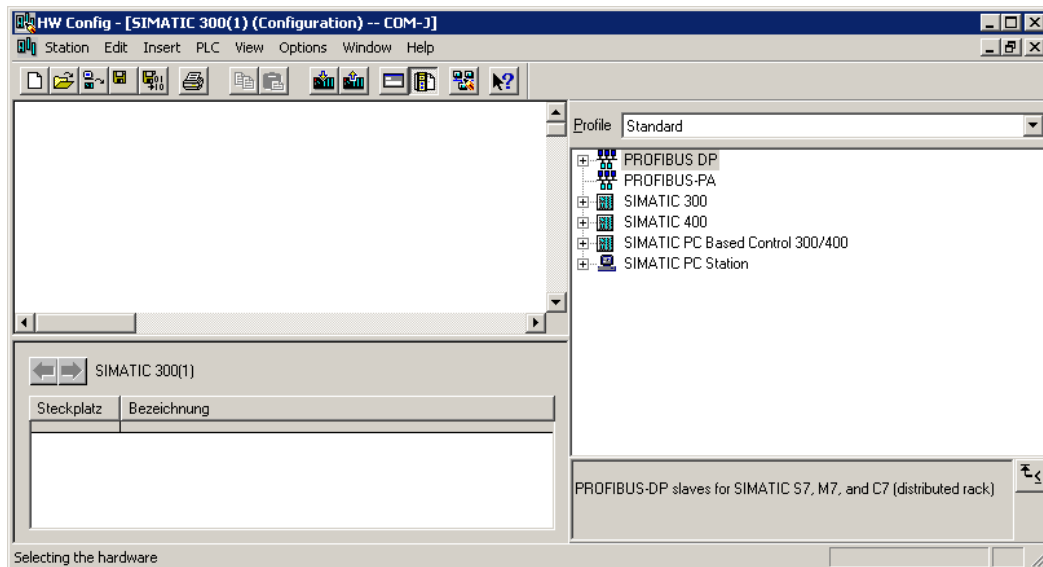
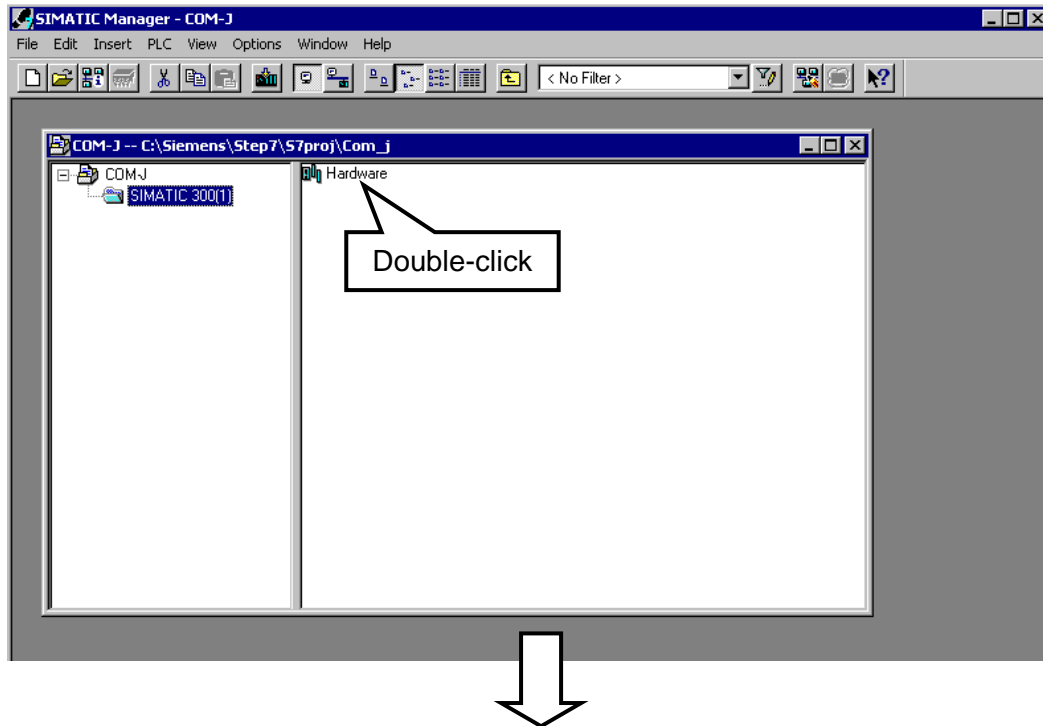

Continued on the next page.

Continued from the previous page.

- Go to the “Options” on the menu bar and click on “Install New GSD...” to register GSD file for COM-JG downloaded from RKC official website.

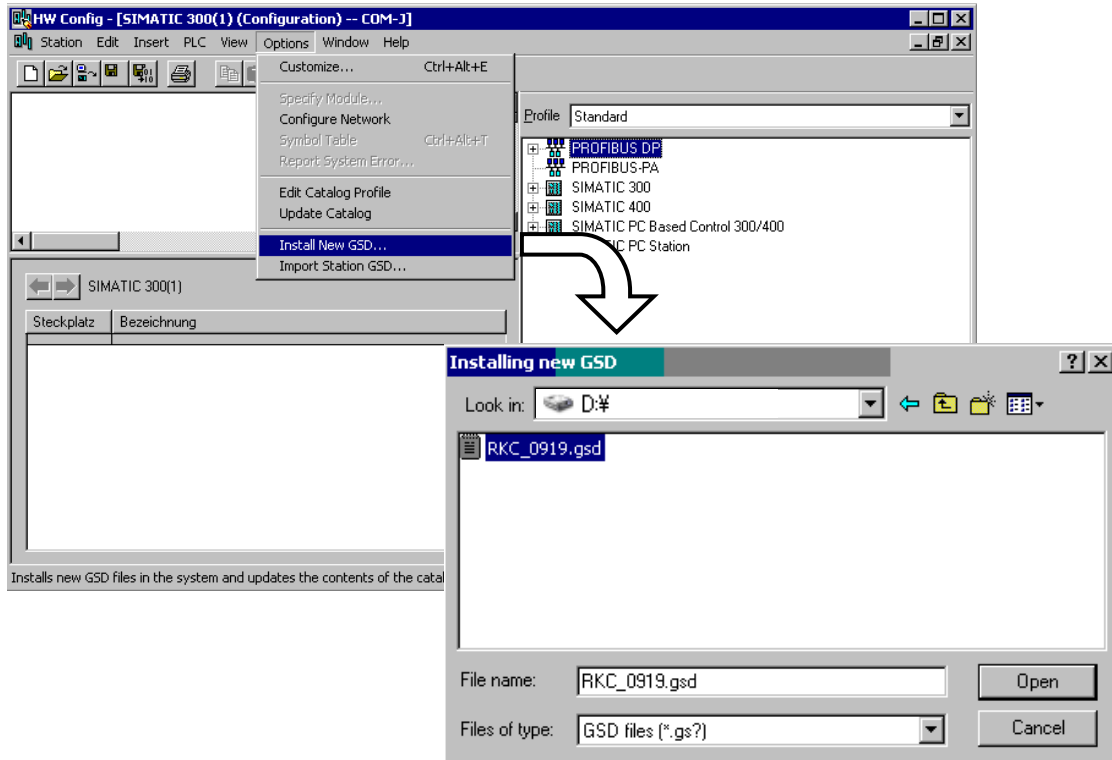

- After the GSD file is registered, “COM-JG” is displayed on the HW configuration screen.

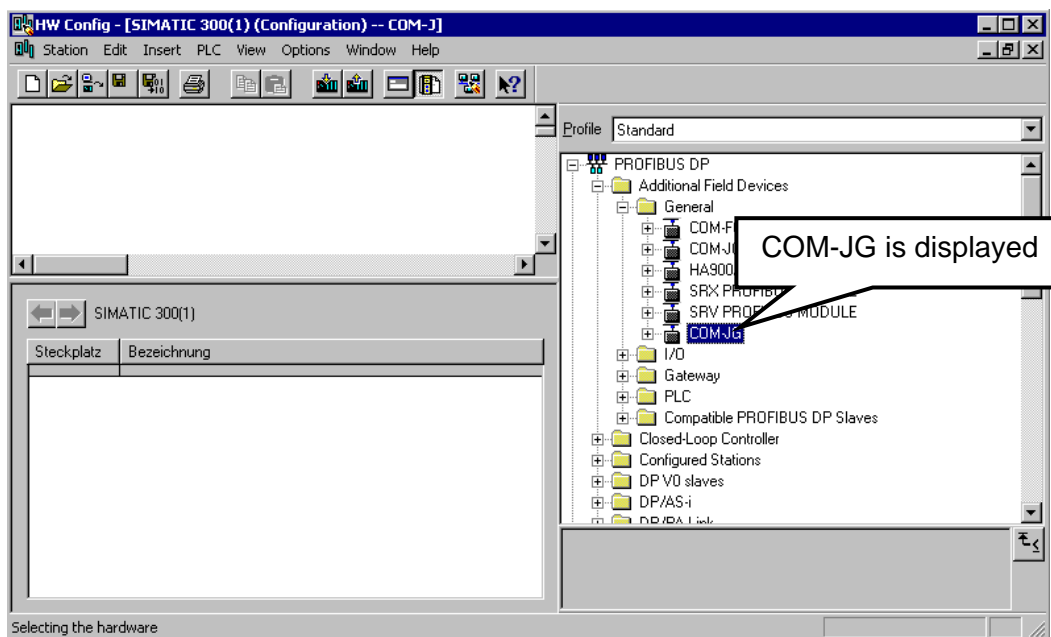

■ PLC master setting

Example:

1. Double-click Rail under “RACK-300” in the folder tree to display rack (RACK).

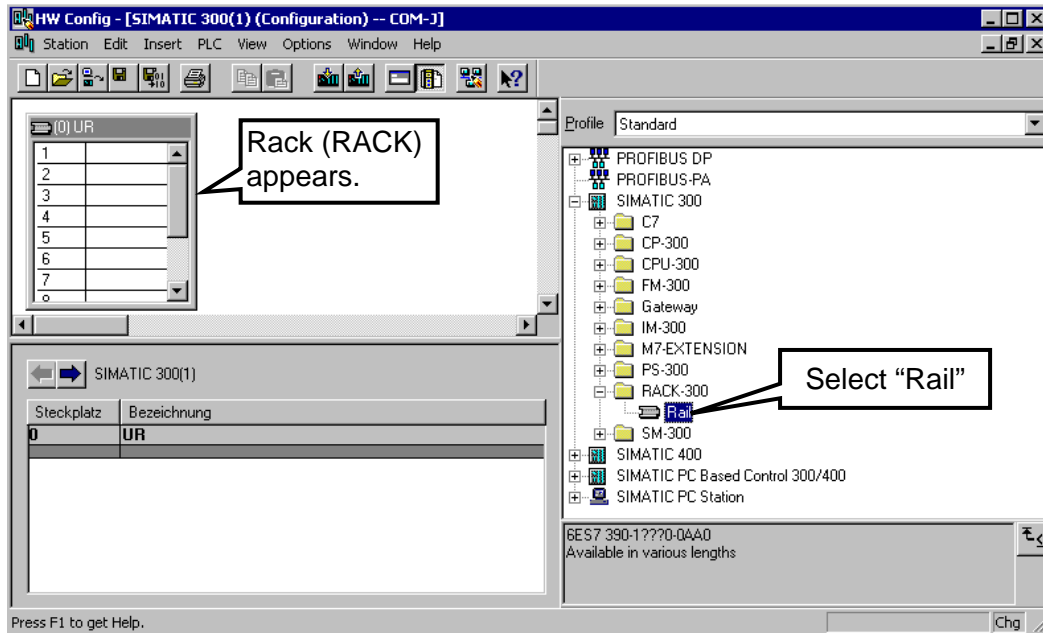

2. Drag and drop “PS 307 2A” of the power supply module, “PS-300” within the rack.

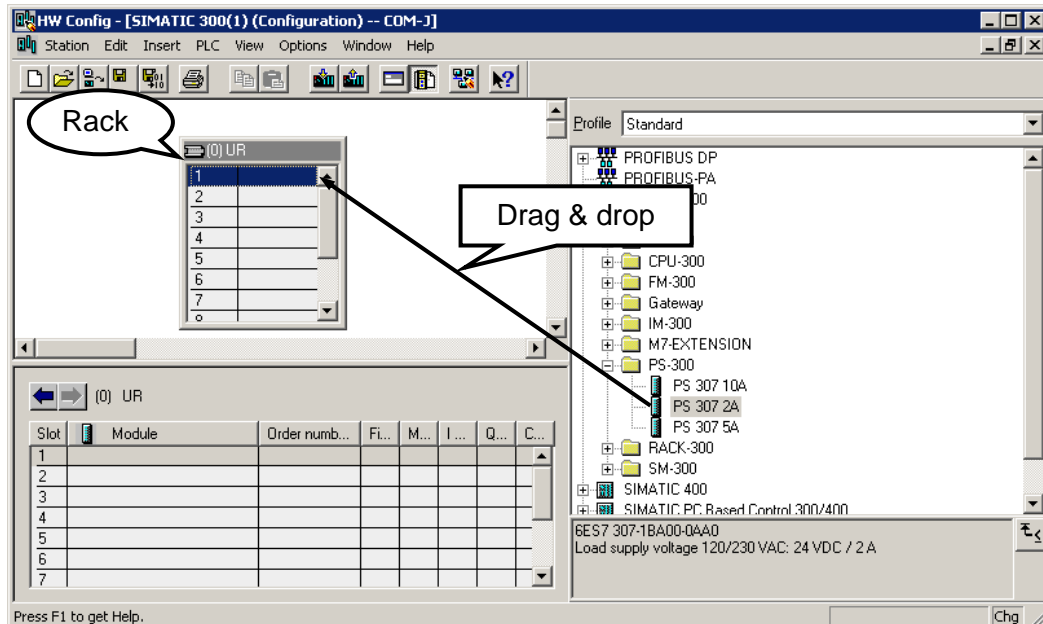

Continued on the next page.

Continued from the previous page.

3. Succeeding drag and drop “6ES7-315-2AF00-0AB0” of the CPU module, “CPU 315-2 DP.”

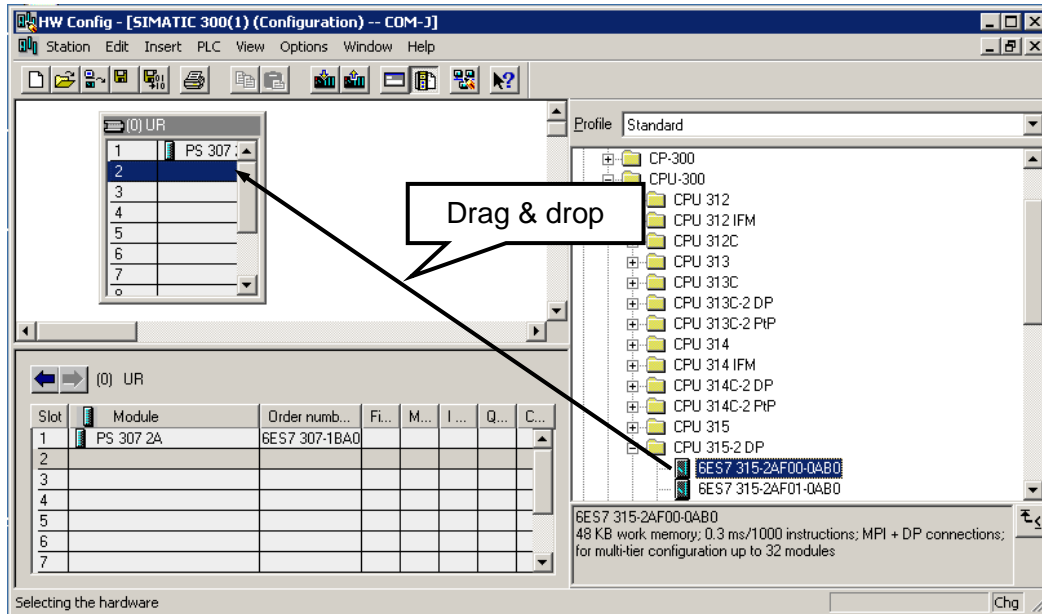

4. As the properties are displayed, click “New...” to set the network. In this example, the “Highest PROFIBUS Address” is set to 126 and the “Transmission Rate,” to 12Mbps.

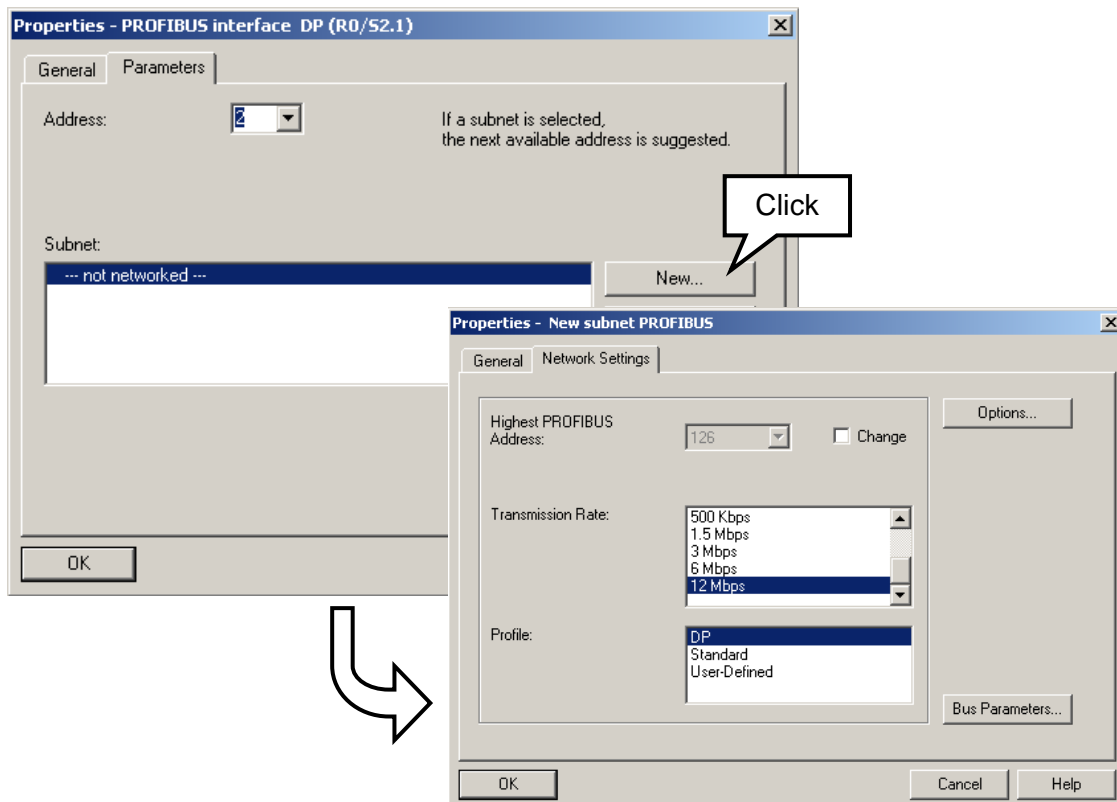

Continued on the next page.

Continued from the previous page.

5. Drag and drop “SM 321 DI16xAC120V” of the DI module, “DI-300.”

Thus, the PLC hardware setting has been finished.

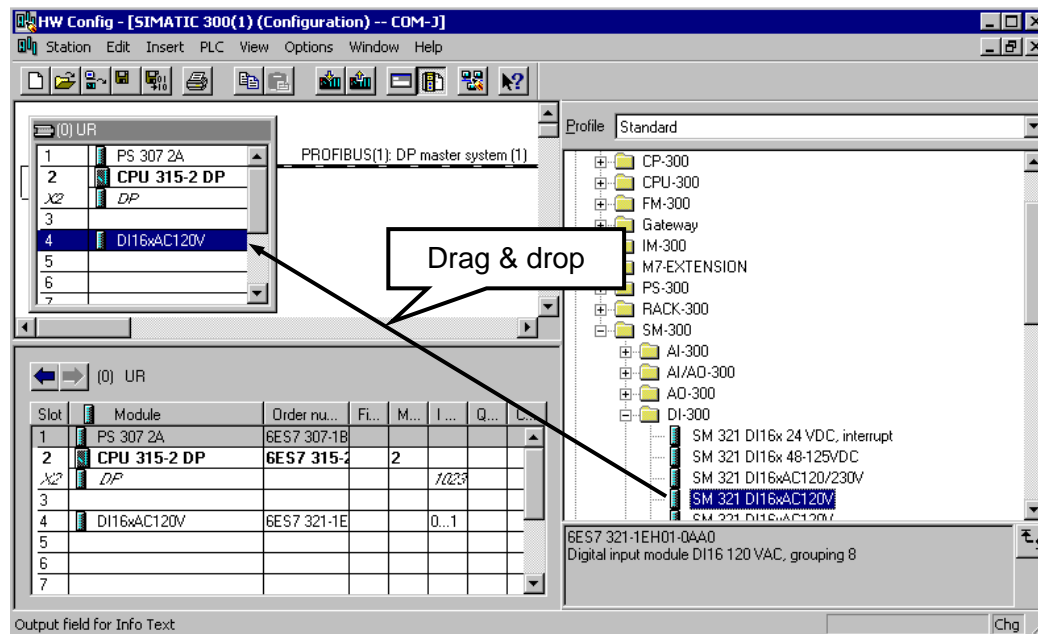

- ☞ For details of the procedure for adding the rack, and Power supply, CPU and Digital input modules and for defining the PROFIBUS master, refer to the instruction manual for Programming Software STEP7.

■ Register a COM-JG

1. Drag and drop “COM-JG” onto “PROFIBUS (1): DP master system (1)” from the tree.

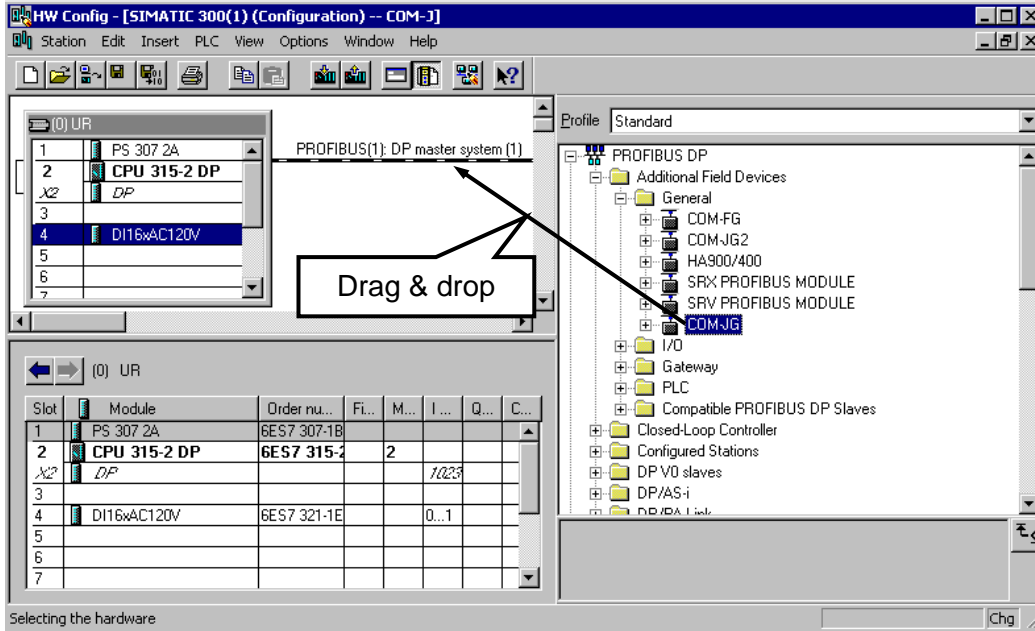

2. As the properties are displayed, set the PROFIBUS address.
In this example, “1” is set.

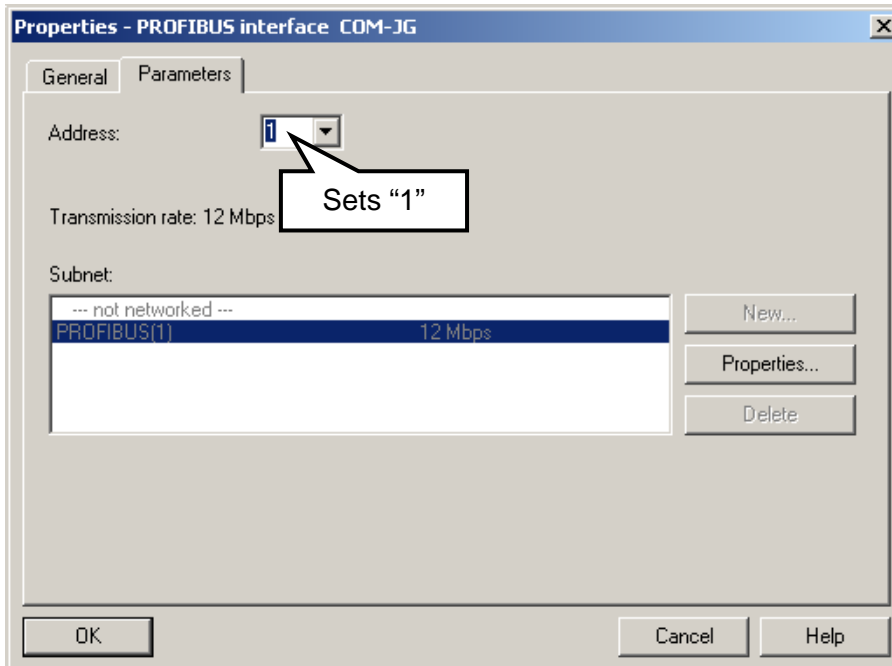

Continued on the next page.

Continued from the previous page.

3. If the COM-JG is registered, the display becomes as follows.

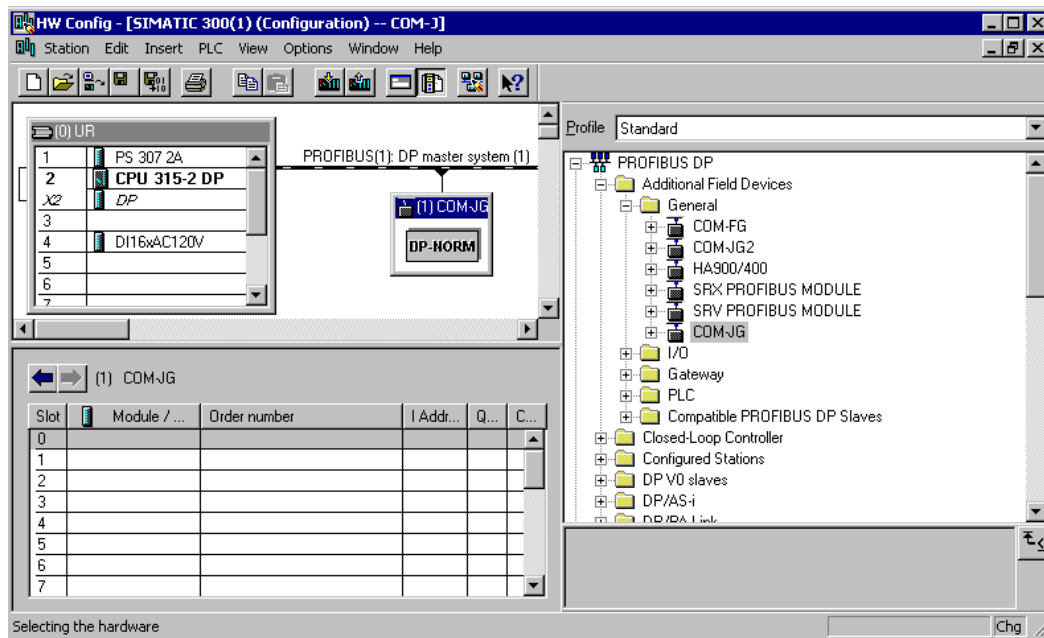

■ **Data parameter setting**

In this example, conduct the setting so that the following static data can be read/written.

Read items: Measured value (PV)

Write item: Set value (SV)

- I. Double-click “COM-JG” registered to set each controller communicating item.

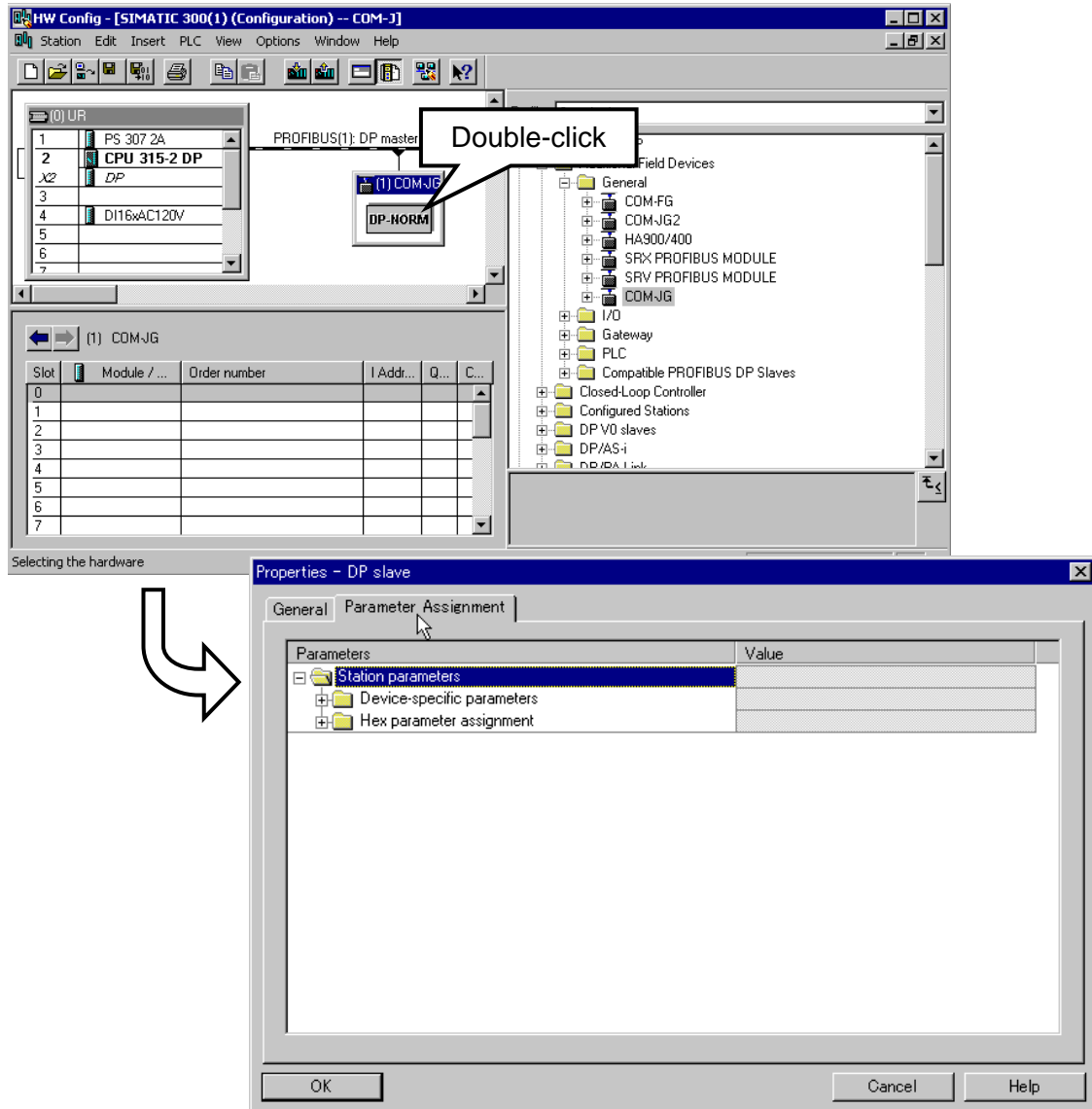

Continued on the next page.

Continued from the previous page.

- Set the number of connecting controllers to “Number of Channel of “Device-specific parameters.”
In this example, set is “1.”

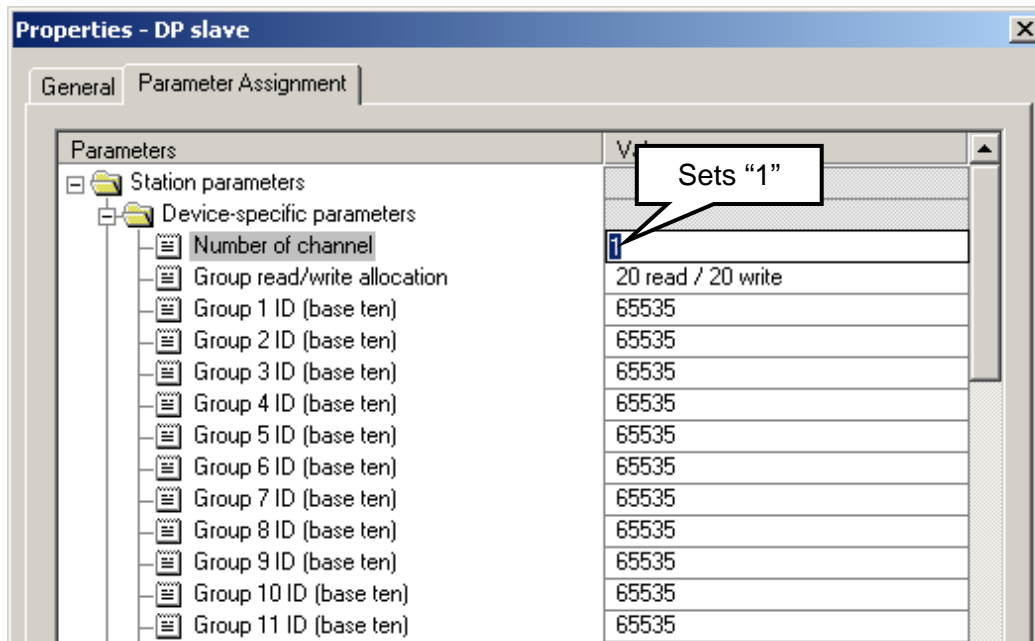

- Set the number of read/write items to “Group read/write allocation.”
In this example, the number of read items set to 30, and the number of write items, to 10.

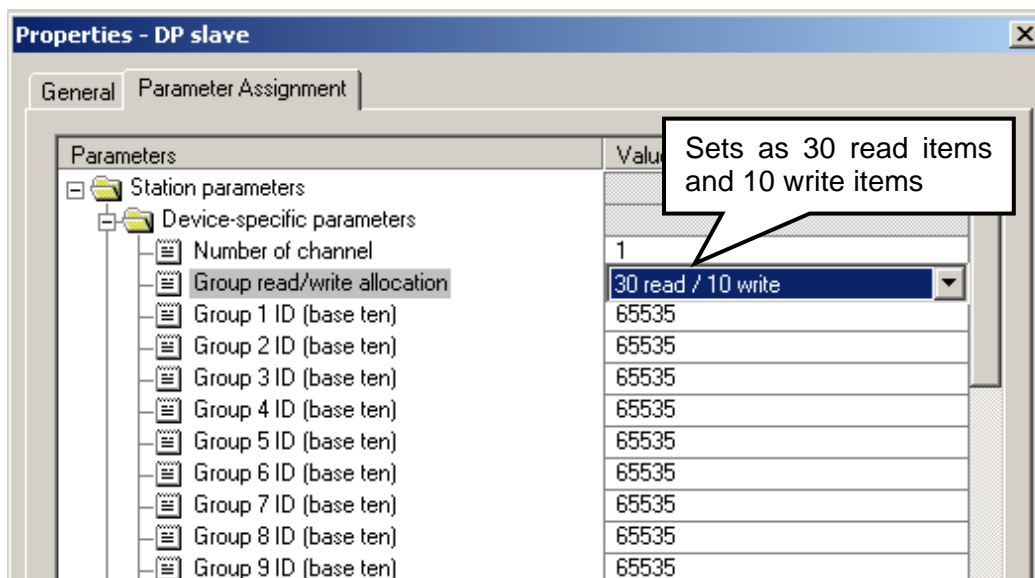

 The number of items that can be set by the COM-JG is 40 maximum including both read and write items.

Continued on the next page.

Continued from the previous page.

4. Set read items in order from “Group 1 ID (base ten).”

The set value sets the Modbus register address of the controller connected in a decimal number. In this example, “0: Measured value (PV)” is set.

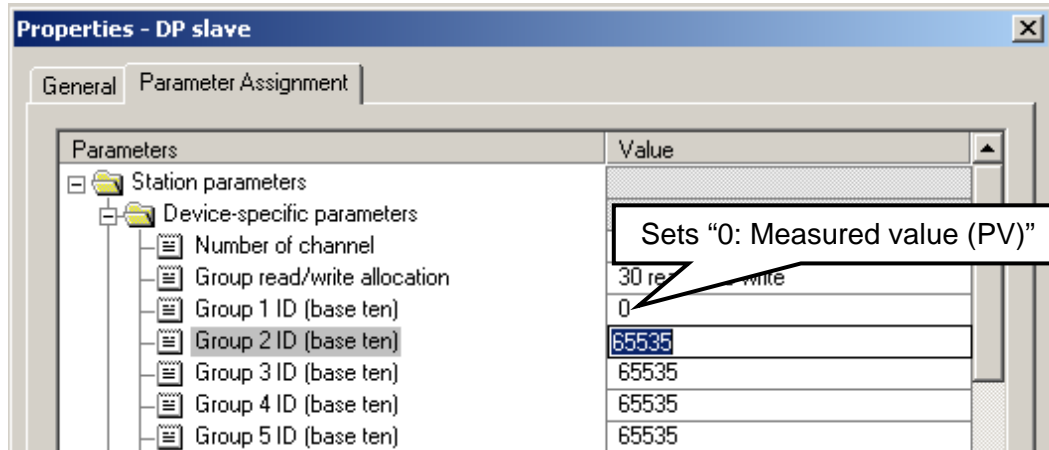

As 30 read items are set by “Group read/write allocation,” Group 1 ID (base ten) to Group 30 ID (base ten) become read items.

5. Set write items in order from “Group 31 ID (base ten).”

The set value sets the Modbus register address of the controller connected in a decimal number. In this example, “44: Set value (SV)” is set.

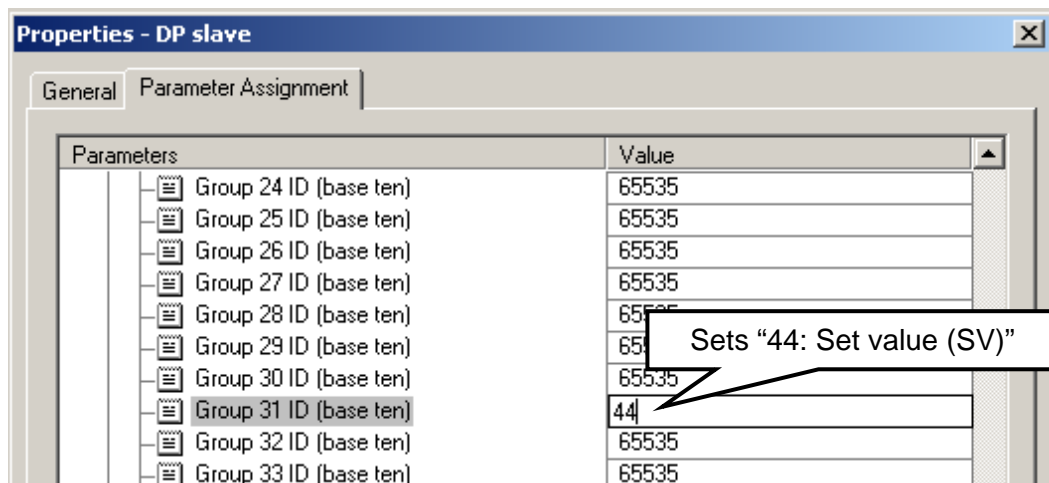

As 10 write items is set by “Group read/write allocation,” Group 31 ID (base ten) to Group 40 ID (base ten) become write items.

Set “0 to 65535” to empty read and write items.

For Modbus register address, refer to **7. COMMUNICATION DATA MAP (P. 24)**.

6. After the allocation of data parameters is finished, click “OK.”

■ Configuration setting

1. Select “COM-JG” and then set the error state register.

Select “Error state” from the tree and then drag and drop it to the COM-JG rack.

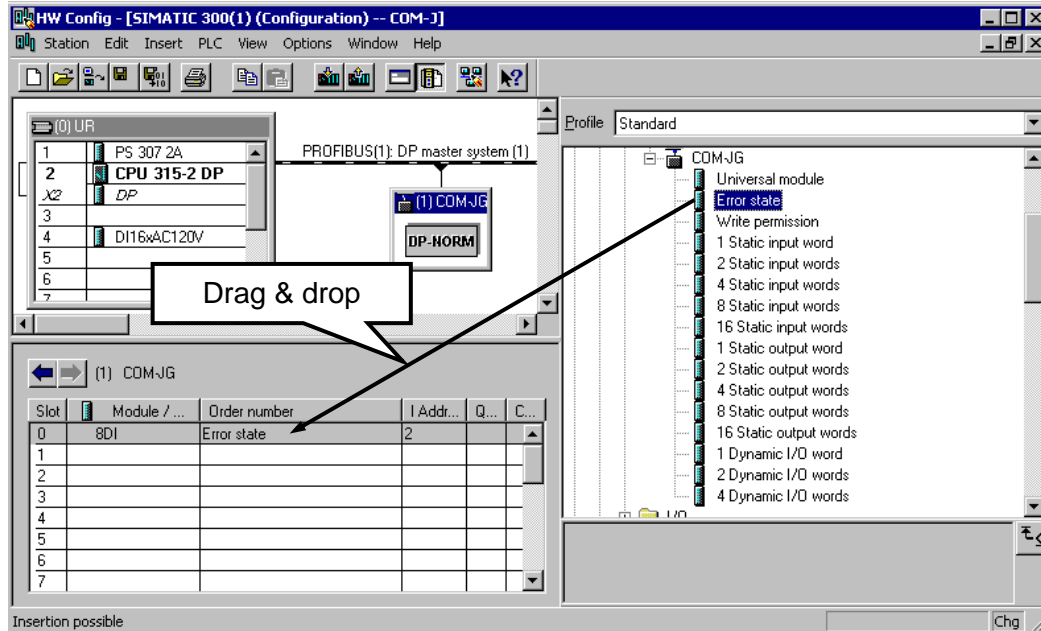

2. Set a write permission register.

Select “Write permission” from the tree and then drag and drop it to the COM-JG rack.

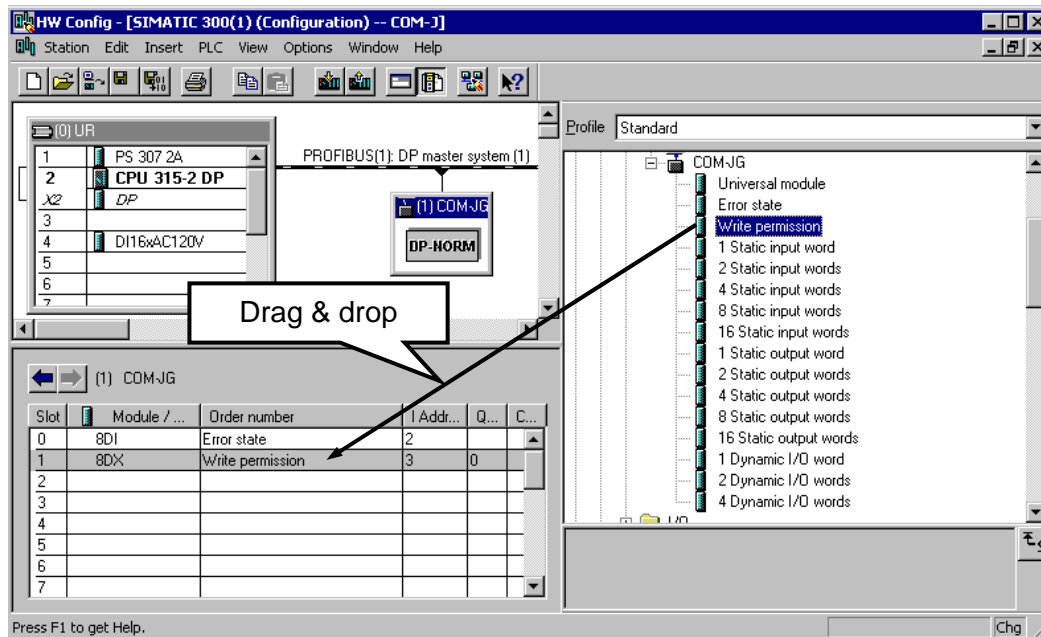

Always set “Error state” and “Write permission” regardless of the contents of communication items. In addition, always set “Error state” to the first line and “Write permission” to the second line.

Continued on the next page.

Continued from the previous page.

3. Set the number of the word of static data.

Read/writes, data length of one item become a single word.

Number of read word = Number of controllers × Number of read items

Number of write word = Number of controllers × Number of write items

Select “Static input word” and “Static output word” from the tree and then drag and drop it to the COM-JG rack. 1/2/4/8/16 words are available.

In this example, there are one controller, and one read item and one write item respectively. Therefore set one word each to read and write.

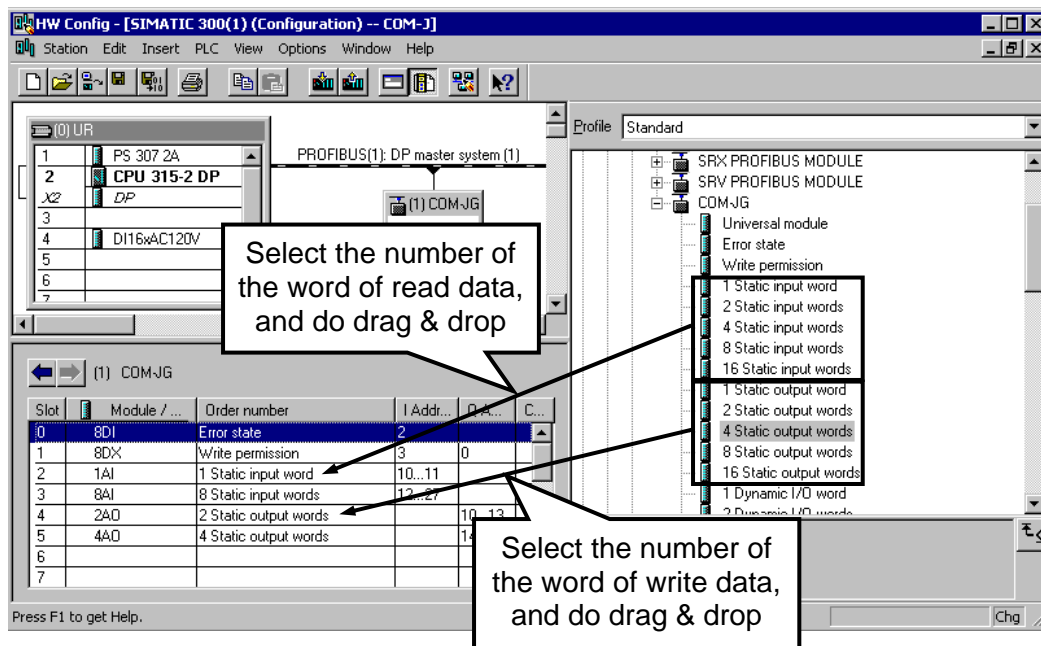

Always locate “Static input” above “Static output” on the rack detail window.



Select and then set the number of words from among 1, 2, 4, 8 and 16 words so that the total number of words becomes the same as “No. of controllers × No. of items.”
For example, if “No. of controllers × No. of items.” Corresponds to five words, select one word and four words.

4. Set the number of the word of dynamic data

In this example, no dynamic data request is used. If used, set the necessary number of words in the same way as for “procedure 3.”



Locate “Dynamic I/O” lower than any other data on the rack detail window.

Continued on the next page.

Continued from the previous page.

5. Set the PLC register address for static data read and write requests.

The screenshot shows the 'Properties - DP slave' dialog box. The 'I/O Type' is set to 'Input'. A callout box points to the 'Start' address field in the 'Input' section, which is set to '10'. The 'End' address is '257', the 'Length' is '1', and the 'Unit' is 'Words'. The 'Consistent over' field is set to 'Unit'. The 'Process image partition' is set to '---'. The 'Data for Specific Manufacturer' field is empty. The 'OK', 'Cancel', and 'Help' buttons are at the bottom.

< Read address >

The screenshot shows the 'Properties - DP slave' dialog box. The 'I/O Type' is set to 'Output'. A callout box points to the 'Start' address field in the 'Output' section, which is set to '10'. The 'End' address is '259', the 'Length' is '2', and the 'Unit' is 'Words'. The 'Consistent over' field is set to 'Unit'. The 'Process image partition' is set to '---'. The 'Data for Specific Manufacturer' field is empty. The 'OK', 'Cancel', and 'Help' buttons are at the bottom.

< Write address >

■ Save and compilation of project

1. Click the “Save and Compile” button on the toolbar, and save and compilation of the project.

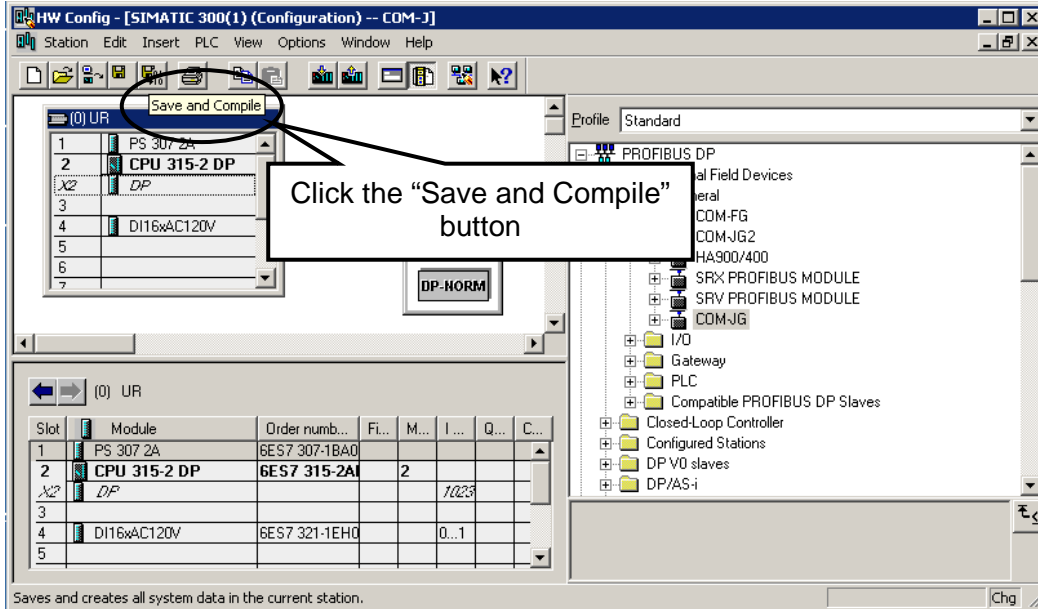

2. Click the “Download to Module” button of toolbar, and download a project to the PLC. If normally downloaded, the window to inform the operator of the progress opens, and then returns to the window for hardware configuration.

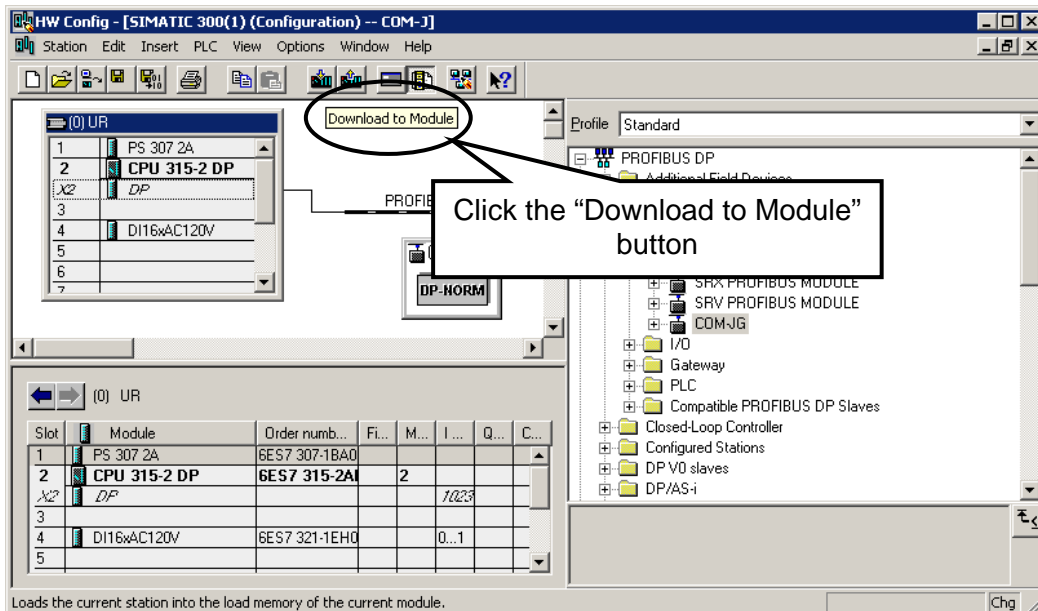

9. TROUBLESHOOTING

This section lists some basic causes and solutions to be taken when any problem would arise in this instrument.

If you can not find a solution, please contact RKC sales office or the agent.

If the instrument is necessary to be replaced, observe the following warning.



WARNING

- To prevent electric shock or instrument failure, always turn off the system power before replacing the instrument.
- To prevent electric shock or instrument failure, always turn off the power before mounting or removing the instrument.
- To prevent electric shock or instrument failure, do not turn on the power until all wiring is completed. Make sure that the wiring is correct before applying power to the instrument.
- To prevent electric shock or instrument failure, do not touch the inside of the instrument.
- All wiring must be performed by authorized personnel with electrical experience in this type of work.

CAUTION

Do not separate the mainframe from the terminal base with the power turned on. If so, instrument failure may result.



When replacing the instrument with a new one, always use the instrument with the same model code. If the instrument is replaced, it is necessary to reset each data item.

■ COM-JG

Problem	Probable cause	Solution
RUN lamp: Turns on RX/TX lamp: Turns off	No connection, disconnection, breakage or wrong wiring of PROFIBUS cable	Confirm the connection method or condition and connect correctly
	Termination setting of a PROFIBUS connector is wrong	Sets termination setting correctly
RUN lamp: Turns on RX/TX lamp: Turns on ONL lamp: Turns off	The PROFIBUS address specified when hardware configured does not match that set by the COM-JG	Match both of the PROFIBUS address
	The read/write static data length (number of words) when hardware configured does not match the data length (number of words) set when communication item assigned	Match both of the data length (number of words) <div style="border: 1px solid black; padding: 5px; margin-top: 10px;">Data length can be calculated by “Number of controllers × Number of items”</div>
	The order of specifying data is incorrect at the time of assigning PLC registers when hardware configured, or two or more essential items are specified	Always specify the data in the following order <ol style="list-style-type: none"> 1. Error state 2. Write permission 3. Static input 4. Static Output 5. Dynamic I/O For the above 3 to 5, two or more items can be specified, but for the above 1 to 2 only one item can be specified
RUN lamp: Flashes	Controller communication is abnormal	Sets communication speed for controller communication and controller address correctly.
	Initializing information is not received from controllers within 30 seconds after the power is turned on	Check to set controller communication address from address number 1 in succession.
Can not recognize the controller	Incorrect sequence of power-on	COM-JG must be powered on last.

10. SPECIFICATIONS

■ PROFIBUS communication

- Interface:** Based on RS-485, EIA standard
Protocol: PROFIBUS-DP
Communication speed: 9600 bps, 19200 bps, 93.75 kbps, 187.5 kbps, 500 kbps, 1.5 Mbps, 12 Mbps
 A master judges the quality situation of a line, and set it automatically.
Communications distance: See table shown below

Communication speed	Maximum network length
12 Mbps	100m
1.5 Mbps	200m
500 Kbps	400m
187.5 Kbps	1000m
93.75 Kbps	1200m
19200 bps	1200m
9600 bps	1200m

- Number of maximum connection nodes:** 1 to 126
Number of stations: 32 stations (Can expand to 126 stations by use of the repeater)
Connection cable: Special cable (Shielded twisted pair wire)
Connection method: Connector
Termination resistor: External installation is necessary
Data access types: Static data read/write, Dynamic data read/write
Communication data length: Up to 170 bytes including both read and writes data.

■ Controller communication

- Interface:** Based on RS-485, EIA standard
Protocol: MODBUS-RTU
Synchronous method: Start/Stop synchronous type
Communication method: 2-wire system, half-duplex multi-drop connection
Communication speed: 9600 bps, 19200 bps, 38400 bps
Data bit configuration: Data 8-bit, Without parity bit, Stop 1-bit
Number of maximum connections: 31 controllers (FB100/400/900) [Device address setting: 1 to 31]
Connection method: Terminals
Termination resistor: Built-in terminal base of COM-JG [ON/OFF select with switch (120 Ω)]

■ Self-diagnostic function

- Hardware error:** Display: FAIL lamp ON
Configuration error (Can not recognize the controller):
 Display: RUN lamp flashes
 Status: Set bit 0 of an error state register

■ **General specifications**

- Power supply voltage:** 21.6 to 26.4 V DC [Including power supply voltage variation] (Rating 24 V DC)
- Current consumption:** 90 mA max. (at 24 V DC)
- Rush current:** 12 A or less
- Insulation resistance:** Between communication terminal and grounding:
20 MΩ or more at 500 V DC
Between power supply terminal and grounding:
20 MΩ or more at 500 V DC
Between power supply terminal and communication terminal:
20 MΩ or more at 500 V DC
- Withstand voltage:** See table shown below

Time: 1 min.	①	②
① Grounding terminal		
② Power supply terminal	600 V AC	
③ Communication terminal	600 V AC	600 V AC

- Power failure:** A power failure of 20 ms or less will not affect the action.
- Data backup:** Data backed up by non-volatile memory
Number of writing: Approx. 100,000 times.
Data storage period: Approx. 10 years
- Vibration:** Amplitude: < 1.5 mm (5 to 9 Hz)
Acceleration: < 5 m/s² (9 to 150 Hz)
Each direction of XYZ axes
- Shock:** Height 50 mm or less
Each direction of XYZ axes (de-energized state)
- Allowable ambient temperature:** -10 to +50 °C
- Allowable ambient humidity:** 5 to 95 % RH
(Absolute humidity: MAX.W.C 29.3 g/m³ dry air at 101.3 kPa)
- Installation environment conditions:** Indoor use
Altitude up to 2000 m
- Operating environments:** Avoid the following conditions when selecting the mounting location.
- Rapid changes in ambient temperature which may cause condensation.
 - Corrosive or inflammable gases.
 - Water, oil, chemicals, vapor or steam splashes.
 - Direct air flow from an air conditioner.
 - Exposure to direct sunlight.
 - Excessive heat accumulation.
- Weight:** Approx. 170 g
- Dimensions:** 30 × 125 × 109.5 mm (W × H × D)

■ **Standard**

- Safety standard:** UL: UL61010-1
cUL: CAN/CSA-C22.2 No.61010-1
- CE marking:** LVD: EN61010-1
EMC: EN61326-1
- RCM:** EN55011



RKC INSTRUMENT INC.

HEADQUARTERS: 16-6, KUGAHARA 5-CHOME, OHTA-KU TOKYO 146-8515 JAPAN

PHONE: 03-3751-9799 (+81 3 3751 9799)

FAX: 03-3751-8585 (+81 3 3751 8585)

E-mail: info@rkcinst.co.jp

Website: <http://www.rkcinst.com/>