

Digital Controller
CB100/CB400/CB500/CB700/CB900
INSTRUCTION MANUAL

IMCB34-E1

Thank you for purchasing this RKC product. In order to achieve maximum performance and ensure proper operation of your new instrument, carefully read all the instructions in this manual. Please place the manual in a convenient location for easy reference.



WARNING

- To prevent injury to persons, damage to instrument and equipment, a suitable external protection device shall be required.
- All wiring must be completed before power is turned on to prevent electric shock, fire or damage to instrument and equipment.
- This instrument must be used in accordance with the specifications to prevent fire or damage to instrument and equipment.
- This instrument is not intended for use in locations subject to flammable or explosive gases.
- Do not touch high-voltage connections such as power supply terminals, etc. to avoid electric shock.
- RKC is not responsible if this instrument is repaired, modified or disassembled by other than factory-approved personnel. Malfunction can occur and warranty is void under these conditions.

CAUTION

- This product is intended for use with industrial machines, test and measuring equipment. (It is not designed for use with medical equipment and nuclear energy.)
- This is a Class A instrument. In a domestic environment, this instrument may cause radio interference, in which case the user may be required to take additional measures.
- This instrument is protected from electric shock by reinforced insulation. Provide reinforced insulation between the wire for the input signal and the wires for instrument power supply, source of power and loads.
- Be sure to provide an appropriate surge control circuit respectively for the following:
 - If input/output or signal lines within the building are longer than 30 meters.
 - If input/output or signal lines leave the building, regardless the length.
- This instrument is designed for installation in an enclosed instrumentation panel. All high-voltage connections such as power supply terminals must be enclosed in the instrumentation panel to avoid electric shock by operating personnel.
- All precautions described in this manual should be taken to avoid damage to the instrument or equipment.
- All wiring must be in accordance with local codes and regulations.
- All wiring must be completed before power is turned on to prevent electric shock, instrument failure, or incorrect action. The power must be turned off before repairing work for input break and output failure including replacement of sensor, contactor or SSR, and all wiring must be completed before power is turned on again.
- To prevent instrument damage as a result of failure, protect the power line and the input/output lines from high currents with a suitable overcurrent protection device with adequate breaking capacity such as a fuse, circuit breaker, etc.
- Prevent metal fragments or lead wire scraps from falling inside instrument case to avoid electric shock, fire or malfunction.
- Tighten each terminal screw to the specified torque found in the manual to avoid electric shock, fire or malfunction.
- For proper operation of this instrument, provide adequate ventilation for heat dispensation.
- Do not connect wires to unused terminals as this will interfere with proper operation of the instrument.
- Turn off the power supply before cleaning the instrument.
- Do not use a volatile solvent such as paint thinner to clean the instrument. Deformation or discoloration will occur. Use a soft, dry cloth to remove stains from the instrument.
- To avoid damage to instrument display, do not rub with an abrasive material or push front panel with a hard object.
- When high alarm with hold action is used for Alarm function, alarm does not turn on while hold action is in operation. Take measures to prevent overheating which may occur if the control device fails.

NOTICE

- This manual assumes that the reader has a fundamental knowledge of the principles of electricity, process control, computer technology and communications.
- The figures, diagrams and numeric values used in this manual are only for purpose of illustration.
- RKC is not responsible for any damage or injury that is caused as a result of using this instrument, instrument failure or indirect damage.
- RKC is not responsible for any damage and/or injury resulting from the use of instruments made by imitating this instrument.
- Periodic maintenance is required for safe and proper operation of this instrument. Some components have a limited service life, or characteristics that change over time.
- Every effort has been made to ensure accuracy of all information contained herein. RKC makes no warranty expressed or implied, with respect to the accuracy of the information. The information in this manual is subject to change without prior notice.
- No portion of this document may be reprinted, modified, copied, transmitted, digitized, stored, processed or retrieved through any mechanical, electronic, optical or other means without prior written approval from RKC.

1. PRODUCT CHECK

CB100						*				/Y
CB400	□	□	□	□	□	□	□	□	□	□
CB500	(1)	(2)	(3)	(4)	(5)	(6)	(7)	(8)	(9)	(10)(11)
CB700										
CB900										

(1) Control action

- F: PID action with autotuning (Reverse action)
- D: PID action with autotuning (Direct action)
- W: Heat/Cool PID action with autotuning (Water cooling)¹
- A: Heat/Cool PID action with autotuning (Air cooling)¹

(2) Input type, (3) Range code: Refer to "9. INPUT RANGE TABLE."

(4) First control output [OUT1] (Heat-side)

- M: Relay contact
- T: Triac
- V: Voltage pulse
- 8: Current (4 to 20 mA DC)
- G: Trigger for triac driving

(5) Second control output [OUT2] (Cool-side)

- No symbol: When control action is F or D.
- M: Relay contact
- T: Triac
- V: Voltage pulse
- 8: Current (4 to 20 mA DC)

(6) Alarm 1 [ALM1], (7) Alarm 2 [ALM2]

- N: No alarm
- A: Deviation high alarm
- B: Deviation low alarm
- C: Deviation high/low alarm
- D: Band alarm
- E: Deviation high alarm with hold action
- F: Deviation low alarm with hold action
- G: Deviation high/low alarm with hold action
- H: Process high alarm
- J: Process low alarm
- K: Process high alarm with hold action
- L: Process low alarm with hold action
- P: Heater break alarm (HBA) [CTL-6]²
- S: Heater break alarm (HBA) [CTL-12]²
- R: Control loop break alarm (LBA)³
- V: SV high alarm
- W: SV low alarm

(8) Communication function

- N: No communication function
- 5: RS-485 (2-wire system)

(9) Waterproof/Dustproof

- N: No Waterproof/Dustproof
- 1: Waterproof/Dustproof

(10) Case color

- N: White
- A: Black

(11) Version symbol

- No code: For Japanese domestic market
- /Y: For International market

¹ No self-tuning function is provided in the W or A control action type.
² Heater break alarm (HBA) cannot be specified in case of ALM1. Also, it isn't possible to specify when control output is current output.
³ As control loop break alarm (LBA), only either the ALM1 or ALM2 is selected.



Check that power supply voltage is also the same as that specified when ordering.

<Accessories>

- Mounting frame (CB100): 1 (KCA100-526)
- Mounting brackets (CB400/500/700/900): 2 *(KCA400-532)
- Instruction manual (IMCB34-E1): 1
- * For CB900 waterproof/dustproof (optional): 4 pieces

2. MOUNTING

2.1 Mounting Cautions

- (1) This instrument is intended to be used under the following environmental conditions. (IEC61010-1)
 [OVERVOLTAGE CATEGORY II, POLLUTION DEGREE 2]
- (2) Use this instrument within the following environment conditions:
 - Allowable ambient temperature: 0 to 50 °C
 - Allowable ambient humidity: 5 to 95 % RH (Absolute humidity: MAX. W. C 29.3 g/m³ dry air at 101.3 kPa)
 - Installation environment conditions: Indoor use, Altitude up to 2000 m
- (3) Avoid the following conditions when selecting the mounting location:
 - Rapid changes in ambient temperature which may cause condensation.
 - Corrosive or inflammable gases.
 - Direct vibration or shock to the mainframe.
 - Water, oil, chemicals, vapor or steam splashes.
 - Excessive dust, salt or iron particles.
 - Excessive induction noise, static electricity, magnetic fields or noise.
 - Direct air flow from an air conditioner.
 - Exposure to direct sunlight.
 - Excessive heat accumulation.
- (4) Mount this instrument in the panel considering the following conditions:
 - Provide adequate ventilation space so that heat does not build up.
 - Do not mount this instrument directly above equipment that generates large amount of heat (heaters, transformers, semi-conductor functional devices, large-wattage resistors.)
 - If the ambient temperature rises above 50 °C, cool this instrument with a forced air fan, cooler, etc. Cooled air should not blow directly on this instrument.
 - In order to improve safety and the immunity to withstand noise, mount this instrument as far away as possible from high voltage equipment, power lines, and rotating machinery.
 - High voltage equipment: Do not mount within the same panel.
 - Power lines: Separate at least 200 mm.
 - Rotating machinery: Separate as far as possible.
 - For correct functioning mount this instrument in a horizontal position.
- (5) In case this instrument is connected to a supply by means of a permanent connection, a switch or circuit-breaker shall be included in the installation. This shall be in close proximity to the equipment and within easy reach of the operator. It shall be marked as the disconnecting device for the equipment.

2.2 Dimensions

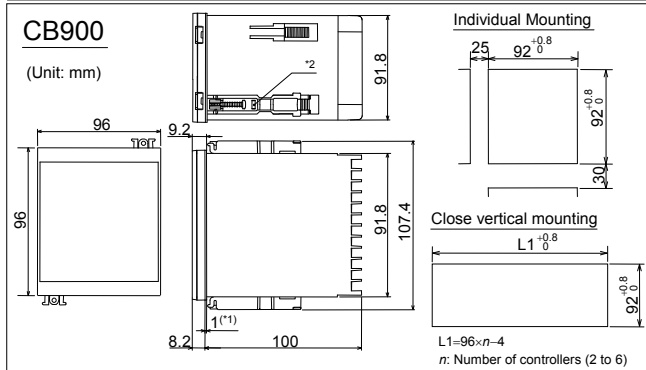
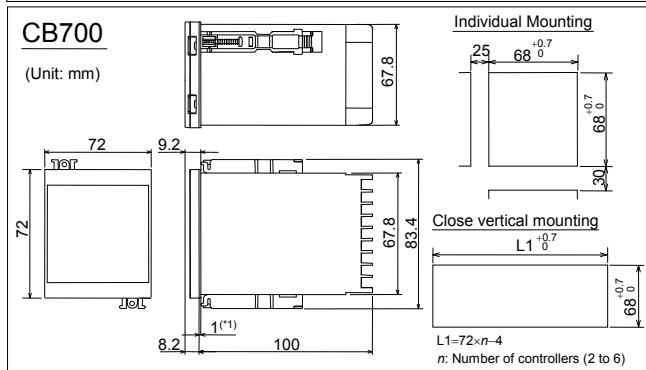
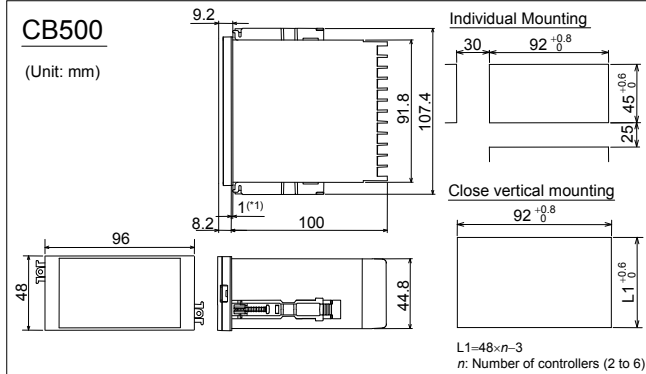
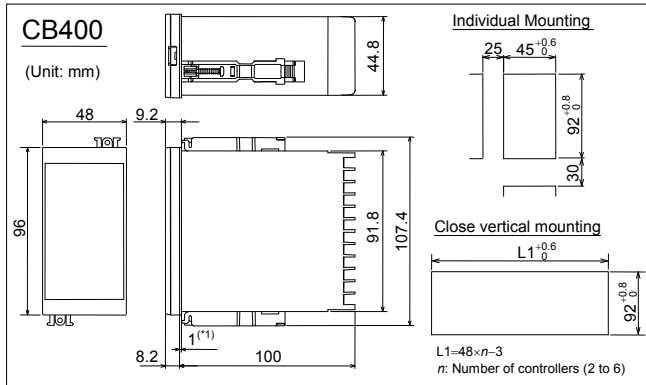
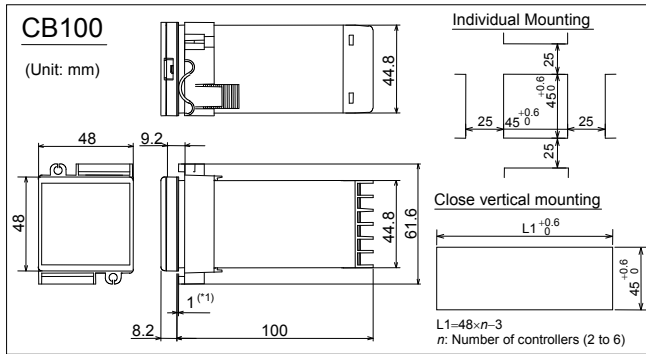

*1 Rubber (optional)

*2 Up to four mounting brackets can be used.

• For mounting of the instrument, panel thickness must be between 1 to 10 mm. (When mounting multiple instruments close together, the panel strength should be checked to ensure proper support.)

• Waterproof and Dustproof are not effective when instruments are closely spaced.

2.3 Mounting Procedures

■ CB100

<Mounting Procedures>

1. Prepare the panel cutout as specified in 2.2 Dimensions.
2. Insert the instrument through the panel cutout.
3. Insert the mounting frame into the mounting groove of the instrument.
4. Push the mounting frame forward until the frame is firmly secured to the panel. (Fig.1)
5. Fix the instrument to the panel by using the two screws. (Fig.2)

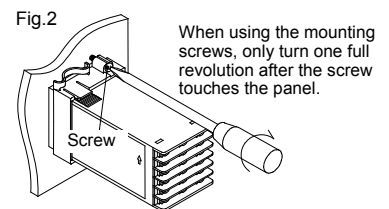
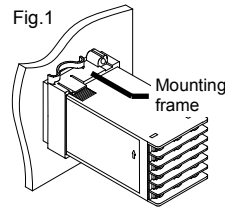

When using the mounting screws, only turn one full revolution after the screw touches the panel.



The optional waterproof/dustproof on the front of the instrument conforms to IP66 when mounted on the panel. For effective waterproof/dustproof, the gasket must be securely placed between instrument and panel without any gap. If the gasket is damaged, please contact RKC sales office or the agent.

<Removal Procedures>

1. Turn the power OFF.
2. Remove the wiring.
3. Loosen the screw of the mounting frame.
4. Remove the mounting frame from the case. (Fig.3)

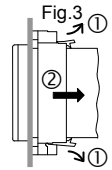

■ CB400/500/700/900

<Mounting Procedures>

1. Prepare the panel cutout as specified in 2.2 Dimensions.
2. Insert the instrument through the panel cutout.
3. Insert the mounting bracket into the mounting groove of the instrument. Do not push the mounting bracket forward. (Fig. 1)
4. Secure the bracket to the instrument by tightening the screw. Take care to refrain from moving the bracket forward.
5. Only turn about one full revolution after the screw touches the panel. (Fig. 2)



If the screw has been rotated too tight, the screw may turn idle. In such a case, loosen the screw once and tighten it again until the instrument is firmly fixed.

6. The other mounting bracket should be installed in the same way as described in 3. to 5.

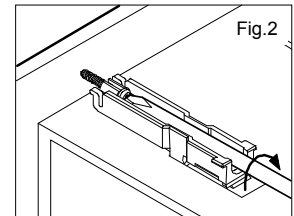
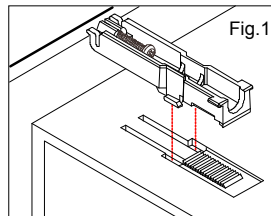

When the instrument is mounted, always secure with two mounting brackets so that upper and lower mounting brackets are positioned diagonally.



The optional waterproof/dustproof (CB900: mounting bracket 4 pieces) on the front of the instrument conforms to IP65 when mounted on the panel. For effective waterproof/dustproof, the gasket must be securely placed between instrument and panel without any gap. If gasket is damaged, please contact RKC sales office or the agent.

<Removal Procedures>

1. Turn the power OFF.
2. Remove the wiring.
3. Loosen the screw of the mounting bracket.
4. Hold the mounting bracket by the edge (①) and tilt it (②) to remove from the case. (Fig. 3)
5. The other mounting bracket should be removed in the same way as described in 3. and 4.
6. Pull out the instrument from the mounting cutout while holding the front panel frame of this instrument. (Fig. 4)

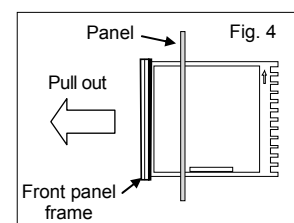
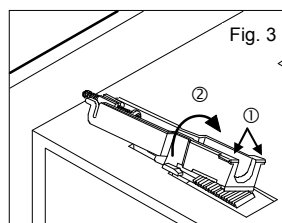

3. WIRING

3.1 Wiring Cautions

- For thermocouple input, use the appropriate compensation wire.
- For RTD input, use low resistance lead wire with no difference in resistance between the three lead wires.
- To avoid noise induction, keep input signal wire away from instrument power line, load lines and power lines of other electric equipment.
- For the current input specification, an external resistor (250 Ω ±0.02 %, 0.25 W or more, ±10 ppm/°C) must be connected between the input terminals. For external resistor (shunt resistor), use the KD100-55: sold separately (RKC product). If this resistor is installed, close horizontal mounting is not possible.
- Signal connected to Voltage input and Current input shall be low voltage defined as "SELV" circuit per IEC 60950-1.
- If there is electrical noise in the vicinity of the instrument that could affect operation, use a noise filter.
 - Shorten the distance between the twisted power supply wire pitches to achieve the most effective noise reduction.
 - Always install the noise filter on a grounded panel. Minimize the wiring distance between the noise filter output and the instrument power supply terminals to achieve the most effective noise reduction.
 - Do not connect fuses or switches to the noise filter output wiring as this will reduce the effectiveness of the noise filter.
- Allow approximately 4 seconds for contact output when the instrument is turned on. Use a delay relay when the output line is used for an external interlock circuit.
- Power supply wiring must be twisted and have a low voltage drop.
- This instrument with 24 V power supply is not provided with an overcurrent protection device. For safety install an overcurrent protection device (such as fuse) with adequate breaking capacity close to the instrument.
 - Fuse type: Time-lag fuse (Approved fuse according IEC60127-2 and/or UL248-14)
 - Fuse rating: Rated current: 0.5 A
- For an instrument with 24 V power supply input, supply power from "SELV" circuit defined as IEC 60950-1.
- A suitable power supply should be considered in end-use equipment. The power supply must be in compliance with a limited-energy circuits (maximum available current of 8 A).
- Use the solderless terminal appropriate to the screw size.
 - Screw size: M3 x 6
 - Recommended tightening torque: 0.4 N·m [4 kgf·cm]
 - Specified solderless terminals: With isolation
 - Applicable wire: Solid/twisted wire of 0.25 to 1.65 mm²
- Make sure that during field wiring parts of conductors can not come into contact with adjacent conductive parts.

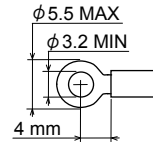
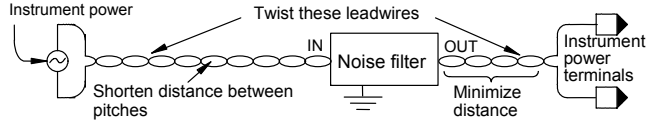

3.2 Terminal Configuration

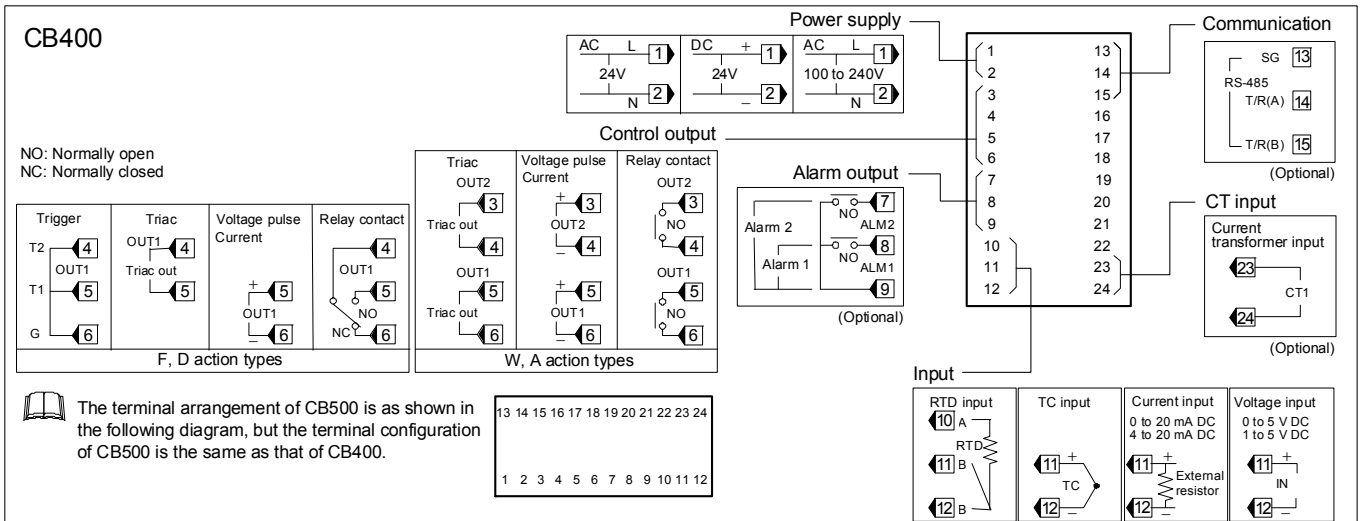
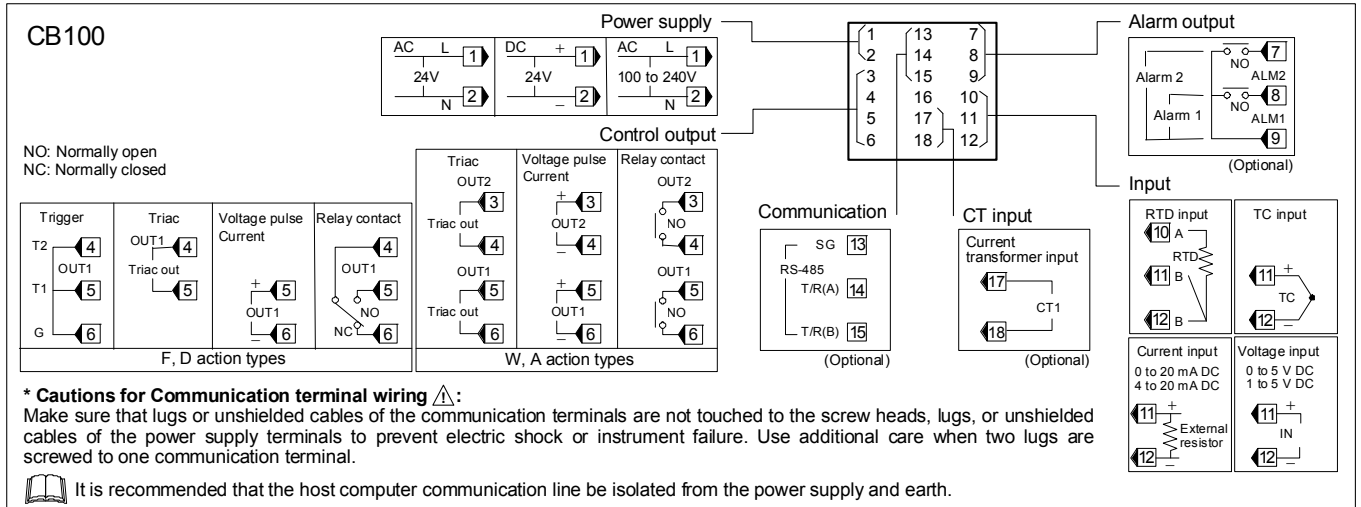

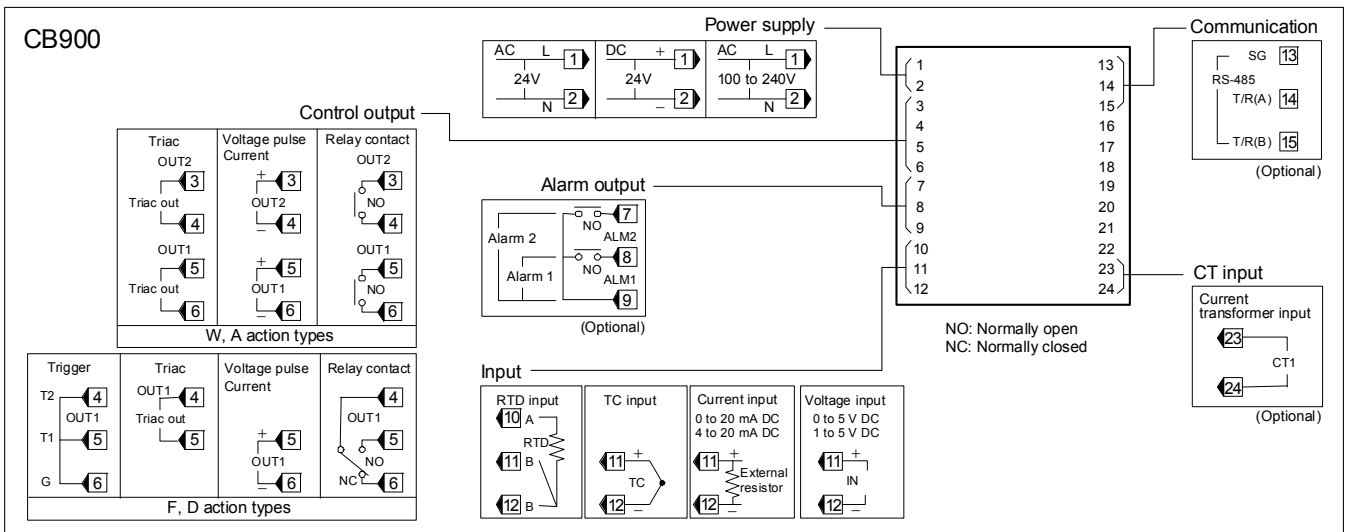
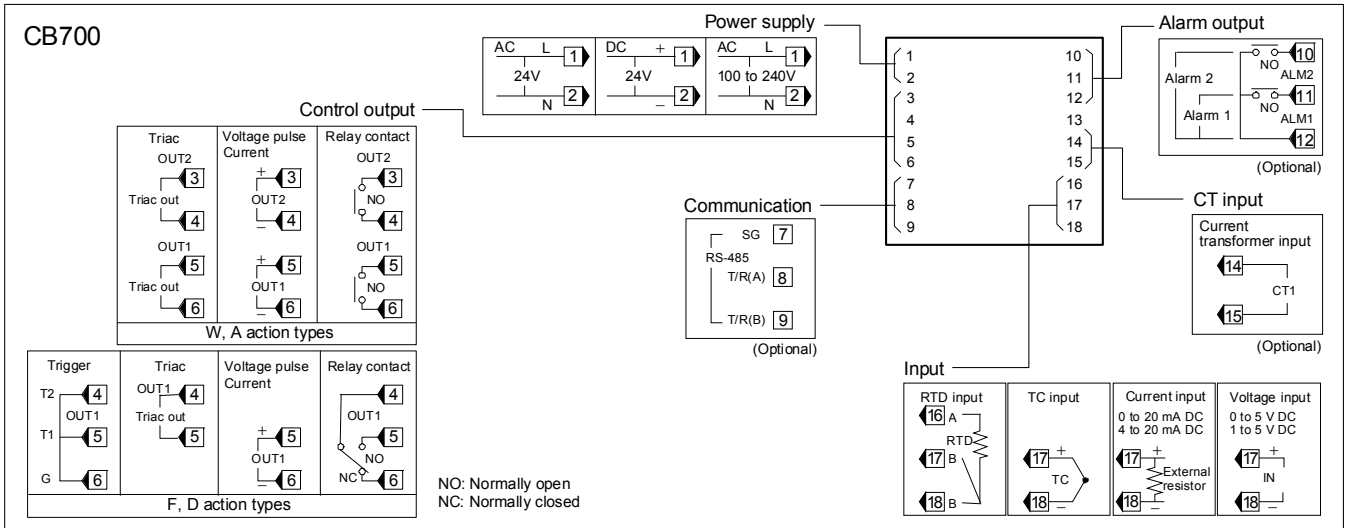

■ Specifications

Input:

Input type:

Thermocouple: K, J, R, S, B, E, T, N, PLII, W5Re/W26Re, U, L
 Input impedance: Approx. 1 MΩ

RTD: Pt100, JPt100

Voltage: 0 to 5 V DC, 1 to 5 V DC, 0 to 10 V DC (Z-1010)

Current: 0 to 20 mA DC, 4 to 20 mA DC

Sampling cycle: 0.5 seconds

Input range: Refer to **Input range table**

Control method:

PID control
 ON/OFF, P, PI, or PD actions is available

Control output:

Relay contact output:

250 V AC, 3A (Resistive load)
 Electrical life: 300,000 times or more (Rated load)

Voltage pulse output:

0/12 V DC (Load resistance 600 Ω or more)

Current output: 4 to 20 mA DC (Load resistance 600 Ω or less)

Trigger output for triac driving:

Zero cross method for medium capacity triac driving (100 A or less)
 Load voltage used: 100 V AC line, 200 V AC line
 Load used: Resistive load

Triac output:

Output method:
 AC output (Zero-cross method)
 Allowable load current:
 0.5 A (Ambient temperature: 40 °C or less)
 Load voltage: 75 to 250 V AC
 Minimum load current: 20 mA
 ON voltage:
 1.6 V or less (at maximum load current)

Alarm output:

Relay contact output:

250 V AC, 1A (Resistive load)
 Electrical life: 50,000 times or more (Rated load)

Performance:

Display accuracy (at the ambient temperature 23 °C ± 2 °C):

Thermocouple:

± (0.3 % of display value + 1 digit) or ± 2 °C [4 °F]

Whichever is greater

R, S and B input: 0 to 399 °C [0 to 799 °F]

Accuracy is not guaranteed.

T and U input: -199.9 to -100.0 °C [-199.9 to -158.0 °F]

Accuracy is not guaranteed.

RTD: ± (0.3 % of display value + 1 digit) or ± 0.8 °C [1.6 °F]

Whichever is greater

Voltage/Current:

± (0.3 % of Input span + 1 digit)

Memory backup:

Backed up by Nonvolatile Memory

Number of write times: Approx. 1,000,000 times

Data storage period: Approx. 10 years

Power:

Power supply voltage:

85 to 264 V AC (Power supply voltage range), 50/60 Hz

Rating: 100 to 240 V AC

21.6 to 26.4 V AC (Power supply voltage range), 50/60 Hz

Rating: 24 V AC

21.6 to 26.4 V DC (Power supply voltage range)

Rating: 24 V DC

Power consumption:

7 VA max. (at 100 V AC)

10 VA max. (at 240 V AC)

5 VA max. (at 24 V AC)

160 mA max. (at 24 V DC)

Weight:

CB100: Approx. 170 g

CB700: Approx. 290 g

CB400/CB500: Approx. 250 g

CB900: Approx. 340 g

4. PARTS DESCRIPTION

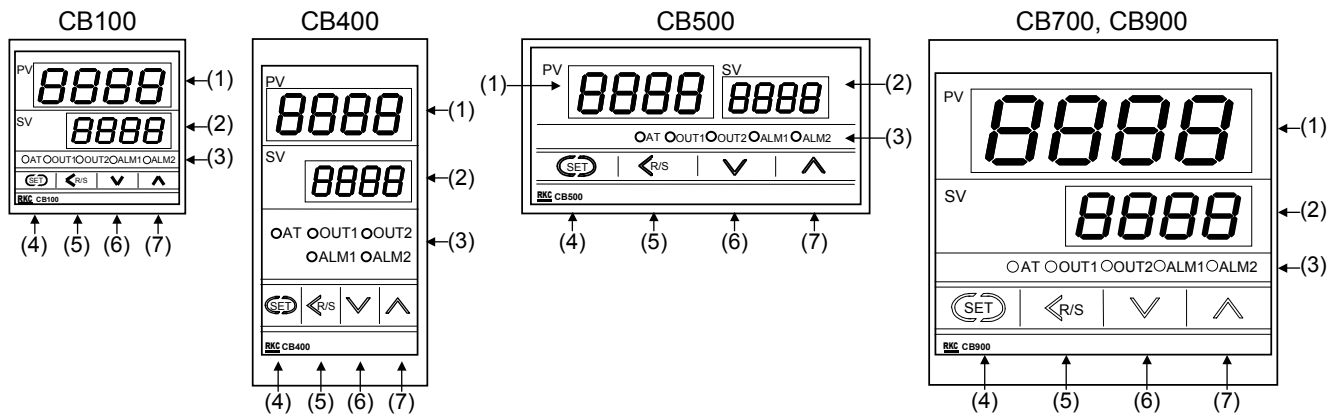

(1) Measured value (PV) display [Green]
Displays PV or various parameter symbols.

(2) Set value (SV) display [Orange]
Displays SV or various parameter set values (or CT input value).

(3) Indication lamps
Alarm output lamps (ALM1, ALM2) [Red]
ALM1: Lights when alarm 1 output is turned on.
ALM2: Lights when alarm 2 output is turned on.

Autotuning (AT) lamp [Green]
Flashes when autotuning is activated. (After autotuning is completed: AT lamp will go out)

Control output lamps (OUT1, OUT2) [Green]
OUT1: Lights when control output is turned on.*
OUT2: Lights when cool-side control output is turned on.*

* Lamp indication becomes as follows for current output.
For an output of less than 0 %: Extinguished
For an output of more than 100 %: Lit
For an output of more than 0 % but less than 100 %: Dimly lit.

(4) SET (Set key)
Used for parameter calling up and set value registration.

(5) <R/S (Shift & R/S key)
Shift digits when settings are changed. Select the RUN/STOP function.

(6) V (DOWN key)
Decrease numerals.

(7) ^ (UP key)
Increase numerals.

To avoid damage to the instrument, never use a sharp object to press keys.

5. SETTING

5.1 Operation Menu

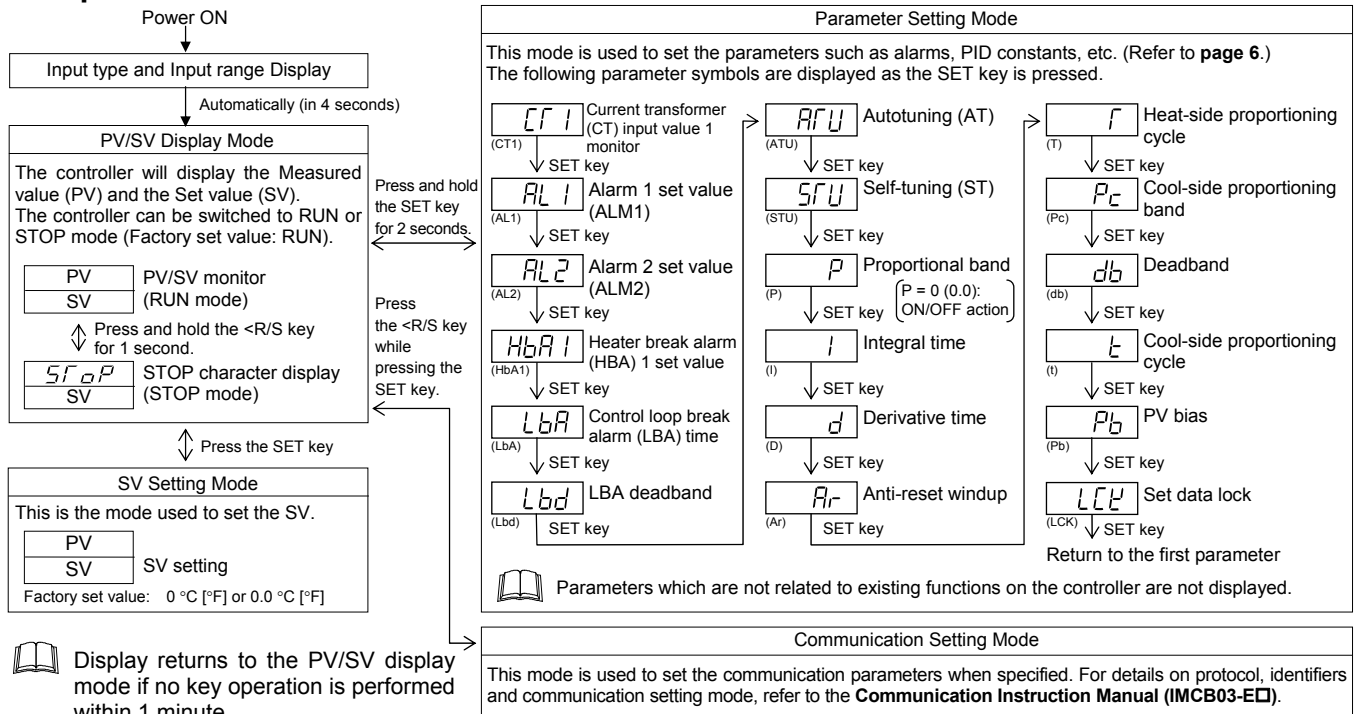

Display returns to the PV/SV display mode if no key operation is performed within 1 minute.

Input type and input range display

This instrument immediately confirms the input type symbol and input range following power ON.
Example: When sensor type of input is K thermocouple.

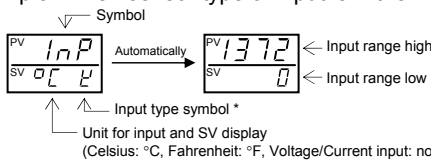

* Input Type Symbol Table

Symbol	Thermocouple (TC)											RTD		Voltage (Current)		
	K	J	R	S	B	E	T	N	PL	II	W5Re/W26Re (*)	U	L		JPt 100	Pt 100
Input type	K	J	R	S	B	E	T	N	PL	II	W5Re/W26Re (*)	U	L	JPt 100	Pt 100	Voltage (Current)

(*): This input type is not displayed in the Z-1021 specification.

5.2 Parameter List



Parameter symbols which are not related to existing functions on the controller are not displayed.

Symbol	Name	Setting range	Description	Factory set value
<i>CT1</i>	Current transformer (CT) input value 1 monitor	0.0 to 100.0 A [Display only]	Display input value from the current transformer. [Displayed only when the instrument has the Heater break alarm (HBA)]	
<i>AL1</i>	Alarm 1 set value (ALM1)	TC/RTD inputs: Deviation alarm, Process alarm, SV alarm: -1999 to +9999 °C [°F] or -199.9 to +999.9 °C [°F]	Set the alarm 1 set value and alarm 2 set value. For the alarm action type, refer to page 10 and 11.	TC/RTD inputs: 50 (50.0)
<i>AL2</i>	Alarm 2 set value (ALM2)	Voltage/Current inputs: Deviation alarm: -Input span to +Input span (Within 9999) Process alarm, SV alarm: Same as input range	Alarm differential gap: TC/RTD inputs: 2 or 2.0 °C [°F] Voltage/Current inputs: 0.2% of Input span	Voltage/Current inputs: 5.0
<i>HBA1</i>	Heater break alarm (HBA) 1 set value ¹	0.0 to 100.0 A	Alarm value is set by referring to input value from the Current transformer (CT). Used only for single-phase.	0.0
<i>LBA</i>	Control loop break alarm (LBA) time ²	0.1 to 200.0 minutes	Set control loop break alarm (LBA) set value.	8.0
<i>Lbd</i>	LBA deadband ³	TC/RTD inputs: 0 to 9999 °C [°F] Voltage/Current inputs: 0 to 100 % of Input span	Set the area of not outputting LBA. No LBA deadband functions with 0 set. Differential gap : TC/RTD inputs: 0.8 °C [°F] Voltage/Current inputs: 0.8 % of Input span	0
<i>ATU</i>	Autotuning (AT)	0: AT end or cancel 1: AT start or execution	Turns the Autotuning ON/OFF.	0
<i>STU</i>	Self-tuning (ST)	0: Self-tuning OFF 1: Self-tuning ON	Turns the Self-tuning ON/OFF.	0
<i>P</i>	Proportional band	TC/RTD inputs: 1 (0.1) to Input span or 9999 (999.9) °C [°F] Voltage/Current inputs: 0.1 to 100.0 % of Input span 0 (0.0): ON/OFF action	Set when PI, PD or PID control is performed. Heat/Cool PID action: Proportional band setting on the heat-side. ON/OFF action differential gap: TC/RTD inputs: 2 (0.2) °C [°F] Voltage/Current inputs: 0.2 % of Input span	TC/RTD inputs: 30 (30.0) Voltage/Current inputs: 3.0
<i>I</i>	Integral time	1 to 3600 seconds (0 second: PD action)	Set the time of integral action to eliminate the offset occurring in proportional control.	240
<i>d</i>	Derivative time	1 to 3600 seconds (0 second: PI action)	Set the time of derivative action to improve control stability by preparing for output changes.	60
<i>Ar</i>	Anti-reset windup (ARW)	1 to 100 % of heat-side proportional band (0 %: Integral action OFF)	Overshooting and undershooting are restricted by the integral effect.	100
<i>r</i>	Heat-side proportioning cycle	1 to 100 seconds (Not displayed if the control output is current output.)	Set control output cycle. Heat/Cool PID action: Heat-side proportioning cycle	Relay contact output: 20 Voltage pulse output/ Trigger output for triac driving/Triac output: 2
<i>Pc</i>	Cool-side proportional band	1 to 1000 % of heat-side proportional band.	Set cool-side proportional band when Heat/Cool PID action.	100
<i>db</i>	Deadband	TC/RTD inputs: -10 to +10 °C [°F] or -10.0 to +10.0 °C [°F] Voltage/Current inputs: -10.0 to +10.0 % of Input span	Set control action deadband between heat-side and cool-side proportional bands. Minus (-) setting results in overlap.	0 or 0.0
<i>t</i>	Cool-side proportioning cycle	1 to 100 seconds (Not displayed if the control output is current output.)	Set control cool-side output cycle for Heat/Cool PID action.	Relay contact output: 20 Voltage pulse output/ Triac output: 2
<i>Pb</i>	PV bias	TC/RTD inputs: -1999 to +9999 °C [°F] or -199.9 to +999.9 °C [°F] Voltage/Current inputs: -Input span to +Input span	Sensor correction is made by adding bias value to Measured value (PV).	0 or 0.0
<i>LCE</i>	Set data lock (LCK)	Parameters other than SV and Alarms 0: Unlock 1: Lock Alarms 0: Unlock 1: Lock SV 0: Unlock 1: Lock Initialization mode 0: Lock 1: Unlock	Performs set data change enable/disable.	0000

1 Heater break alarm (HBA) function

The HBA function monitors the current flowing through the load by a dedicated Current transformer (CT), compares the measured value with the HBA set value, and detects a fault in the heating circuit.

Low or No current flow (Heater break, malfunction of the control device, etc.):

When the control output is ON and the current transformer input value is equal to or less than the heater break determination point for the preset number of consecutive sampling cycle, an alarm is activated.

Over current or short-circuit:

When the control output is OFF and the current transformer input value is equal to or greater than the heater break determination point for the preset number of consecutive sampling cycle, an alarm is activated.



Precaution for HBA setting:

- Displayed only for when HBA is selected as Alarm 2.
- HBA is not available on a current output.
- Set the set value to approximately 85 % of the maximum reading of the CT input.
- Set the set value to a slightly smaller value to prevent a false alarm if the power supply may become unstable.
- When more than one heater is connected in parallel, it may be necessary to increase the HBA set value to detect a single heater failure.
- When the current transformer is not connected, the HBA is turned on.

2 Control loop break alarm (LBA) function

The LBA function is used to detect a load (heater) break or a failure in the external actuator (power controller, magnet relay, etc.), or a failure in the control loop caused by an input (sensor) break. The LBA function is activated when control output reaches 0 % (low limit with output limit function) or 100 % (high limit with output limit function). LBA monitors variation of the measured value (PV) for the length of LBA time. When the LBA time has elapsed and the PV is still within the alarm determination range, the LBA will be ON.



Precaution for LBA setting:

- Displayed only for when LBA is selected as Alarm 1 or Alarm 2.
- No LBA function can be used at Heat/Cool PID control action.
- The LBA function can not be activated when AT function is turned on.
- The LBA function is activated when control output reaches 0 % or 100 %. The time required for the LBA output to turn on includes both the time from the initial occurrence of loop failure and the LBA setting time. Recommended setting for LBA is for the set value of the LBA to be twice the value of the Integral time (I).
- If LBA setting time does not match the controlled object requirements, the LBA setting time should be lengthened. If setting time is not correct, the LBA will malfunction by turning on or off at inappropriate times or not turning on at all.

3 LBA deadband function

The LBA may malfunction due to external disturbances. To prevent malfunctioning due to external disturbance, LBA deadband (LBD) sets a neutral zone in which LBA is not activated. When the Measured value (PV) is within the LBD area, LBA will not be activated. If the LBD setting is not correct, the LBA will not work correctly.

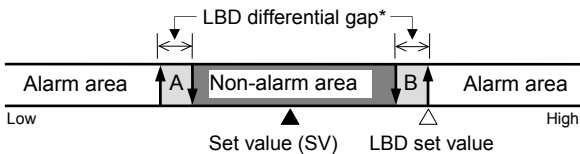

A: During temperature rise: Alarm area B: During temperature rise: Non-alarm area
 During temperature fall: Non-alarm area During temperature fall: Alarm area

* TC and RTD inputs: 0.8 °C [°F] (fixed)
 Voltage/Current inputs: 0.8 % of input span (fixed)

5.3 Changing Parameter Settings

Procedures to change parameter settings are shown below.

To store a new value for the parameter, always press the SET key. The display changes to the next parameter and the new value will be stored.

- A new value will not be stored without pressing SET key after the new value is displayed on the display.
- After a new value has been displayed by using the UP and DOWN keys, the SET key must be pressed within 1 minute, or the new value is not stored and the display will return to the PV/SV monitor screen.

● Change the Set value (SV)

Change the Set value (SV) from 0 °C to 200 °C

1. Select the SV setting mode

Press the SET key at PV/SV monitor screen until SV setting screen is displayed.

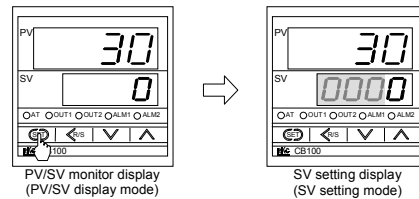

2. Shift the high-lighted digit

Press the <R/S key to high-light the hundreds digit. The high-lighted digit indicates which digit can be set.

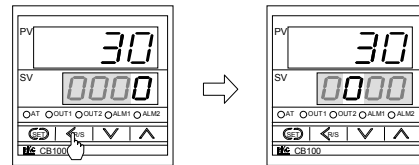

3. Change the set value

Press the UP key to change the number to 2.

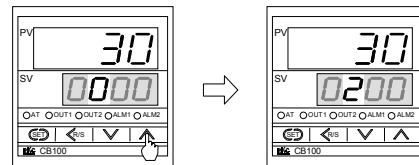

4. Store the set value

Press the SET key to store the new set value. The display returns to the PV/SV monitor screen.

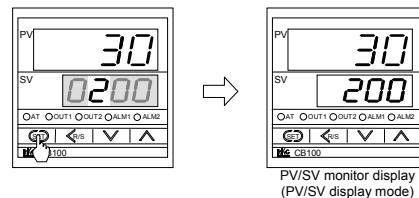

● Change parameters other than the Set value (SV)

The changing procedures are the same as those of example 2 to 4 in the above "● Change the Set value (SV)". Pressing the SET key after the setting end shifts to the next parameter. When no parameter setting is required, return the instrument to the PV/SV display mode.

6. OPERATIONS

CAUTIONS

- All mounting and wiring must be completed before the power is turned on. If the input signal wiring is disconnected or short-circuited (RTD input only), the instrument determines that burnout has occurred.
- Displays:
 - Upscale: Thermocouple input, RTD input (when input break)
 - Downscale: Thermocouple input (specify when ordering), RTD input (when short-circuited), Voltage input (1 to 5 V DC), Current input (4 to 20 mA DC)
 - For the voltage (0 to 5 V DC, 0 to 10 V DC*) or current (0 to 20 mA DC) input, the display becomes indefinite (display of about zero value).
 - * Z-1010 specification
- Outputs:
 - Control output: OFF (Heat/Cool control: the control output on both heat-side and cool-side is turned off)
 - Alarm output: Both of the Alarm 1 and Alarm 2 outputs of this instrument are turned on when burnout occurs regardless of any of the following actions taken (High alarm, low alarm, etc.). In addition, when used for any purposes other than these alarms (event, etc.), specify the Z-124 specification (not to be forcibly turned on).
- A power failure of 20 ms or less will not affect the control action. When a power failure of more than 20 ms occurs, the instrument assumes that the power has been turned off. When power returns, the controller will retain the conditions that existed prior to shut down.
- The alarm hold action is activated when not only the power is turned on, but also the SV is changed.

6.1 Operation Procedures

1. Prior to starting operation, check that the mounting and wiring have been finished, and that the SV and various parameters have been set.
2. A power supply switch is not furnished with this instrument. It is ready to operate as soon as the power is turned on. (Factory set value: RUN).

 This instrument holds the conditions that exist just before the power is turned on. For example, if the power is turned off in STOP mode, the instrument starts in STOP mode when the power is turned on again.

■ RUN/STOP

Each time the <R/S> key is pressed for 1 second, RUN/STOP mode changes from RUN to STOP or STOP to RUN. If the instrument is switched to STOP mode, its display, output, etc. become as follows.

- Display: The PV display shows $STOP$ (STOP).
- Output: Control output OFF, Alarm output OFF
- Autotuning: AT canceled (The PID constants are not updated.)

■ RUN/STOP display (Z-1018 specification)

When operation is changed to the STOP mode by RUN/STOP selection, a parameter symbol to indicate the STOP mode is displayed on the SV display. Pressing the SET key with the STOP mode displayed can also check and change the Set value (SV).

6.2 Set Data Lock (LCK) Function

The set data lock restricts parameter setting changes by key operation. This function prevents the operator from making errors during operation. There are 8 set data lock levels. (refer to below)

Set value	Parameters which can be changed
0000	All parameters [Factory set value]
0001	SV, Alarms (ALM1, ALM2)
0010	All parameters except for Alarms (ALM1, ALM2)
0011	SV
0100	All parameters except for SV
0101	Alarms (ALM1, ALM2)
0110	All parameters except for SV and Alarms (ALM1, ALM2)
0111	No parameters (All Locked)

HBA, LBA and LBD can be locked when any of 0001, 0011, 0101 and 0111 is set.

 Set data lock can be changed in both RUN and STOP mode.

 Parameters protected by Set data lock function are still displayed for monitoring.

6.3 Autotuning (AT) Function

Autotuning (AT) automatically measures, computes and sets the optimum PID and LBA constants. The following conditions are necessary to carry out Autotuning and the conditions which will cause the Autotuning to stop.

 **Caution for using the Autotuning (AT)**
When a temperature change (UP and/or Down) is 1 °C or less per minute during AT, AT may not be finished normally. In that case, adjust the PID values manually. Manual setting of PID values may also be necessary if the set value is around the ambient temperature or is close to the maximum temperature achieved by the load.

■ Requirements for AT start

Start the Autotuning when all following conditions are satisfied:

- Prior to starting the AT function, end all the parameter settings other than PID and LBA.
- Confirm the LCK function has not been engaged.

 When the Autotuning is finished, the controller will automatically returns to PID control.

■ Requirements for AT cancellation

The Autotuning is canceled if any of the following conditions exist.

- When the Set value (SV) is changed.
- When the PV bias value is changed.
- When the RUN/STOP mode is changed to the STOP mode.
- When the PV becomes abnormal due to burnout.
- When the power is turned off.
- When power failure longer than 20 ms occurs.
- When the AT does not end in 9 hours after autotuning started.

 If the AT is canceled, the controller immediately changes to PID control. The PID values will be the same as before AT was activated.

 When AT is completed, the controller immediately changes to PID control. If the control system does not allow the AT cycling process, set each PID constant manually to meet the needs of the application.

6.4 Self-tuning (ST) Function

The ST function is used to automatically calculate and set adaptive PID constants anytime the power is turned on, the SV is changed or the controller detects unstable control conditions.

 **The ST function should be turned off when the controlled system is affected by rippling that occurs due to periodic external disturbances.**

 **The power to the controlled system must be turned on before the power to the instrument is turned on or SV is changed. This is required when ST function is on.**

 **To activate the ST function, the following parameters must not be set to zero: P≠0, I≠0, D≠0, ARW≠0.**

 When Heat/Cool PID action is selected, the ST function can not be activated.

 When the AT function is activated, the ST function can not be turned on.

 When the ST function is activated, the PID and ARW settings can be monitored, but not changed.

7. INITIAL SETTING

! WARNING

Parameters in the Initialization mode should be set according to the application before setting any parameter related to operation. Once the Parameters in the Initialization mode are set correctly, no further changes need to be made to parameters for the same application under normal conditions. If they are changed unnecessarily, it may result in malfunction or failure of the instrument. RKC will not bear any responsibility for malfunction or failure as a result of improper changes in the Initialization mode.

7.1 Go to Initialization Mode

- Turn on the power to this controller. The instrument goes to the PV/SV display after confirming input type symbol and input range.
- Press and hold the SET key for 2 seconds to go to the Parameter Setting Mode from the PV/SV display.
- Press the SET key until "LCK" (Set data lock display) will be displayed.
- The high-lighted digit indicates which digit can be set. Press <R/S key to high-light the thousands digit. (The section in each image of the controller shows the digits which are not high-lighted.)

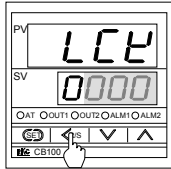

Set data lock function display

- Press the UP key to change 0 to 1.

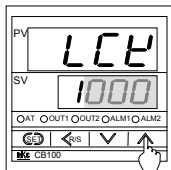

Set value
 0: Initialization mode locked
 1: Initialization mode unlocked

- Press the SET key to store the new set value. The display goes to the next parameter, and the Initialization mode is unlocked.

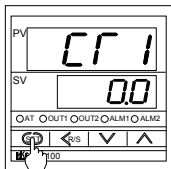

CT1 input value display

The parameter displayed varies on the instrument specification.

- Press the <R/S key for two seconds while pressing the SET key to go to the Initialization mode. When the controller goes to the Initialization mode, "Cod" will be displayed.

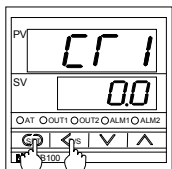

CT1 input value display

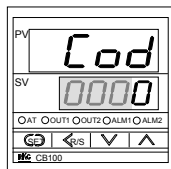

Initialize code selection display of initialization mode

Cod 0000	SL1 (Input type selection)	Refer to P. 10
	SL2 (Temperature unit and cooling type selection)	Refer to P. 10
	SL4 (Alarm 1 type selection)	Refer to P. 10
	SL5 (Alarm 2 type selection)	Refer to P. 10
	SL11 (SV alarm type selection)	Refer to P. 11
Cod 0001	SLH (Setting limiter [high])	Refer to P. 11
	SLL (Setting limiter [low])	Refer to P. 11
	PGdP (Decimal point position)	Refer to P. 11

7.2 Exit Initialization Mode

When any parameter setting is changed in the Initialization mode, check all parameter set values in SV setting mode and Parameter setting mode.

- Press the <R/S key for 2 seconds while pressing the SET key from any display in the Initialization mode. The controller goes back to the operation mode and the PV/SV display will be displayed.
- Press and hold the SET key for 2 seconds in the PV/SV display.
- Press the SET key until "LCK" (Set data lock display) will be displayed.
- The high-lighted digit indicates which digit can be set. Press <R/S key to high-light the thousands digit. (The section in each image of the controller shows the digits which are not high-lighted.)
- Press the DOWN key to change 1 to 0.

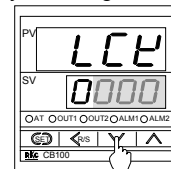

Set data lock function display

- Press the SET key to store the new set value. The display goes to the next parameter, and the Initialization mode is locked.

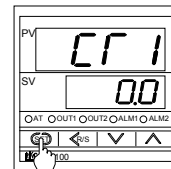

CT1 input value display

The parameter displayed varies on the instrument specification.

7.3 Initial Setting Menu

The "Cod" display will be displayed when the controller goes to the Initialization mode.

Do not change to any parameter in the Initialization mode which is not described in the initial setting menu above. It may result in malfunction or failure of the instrument.

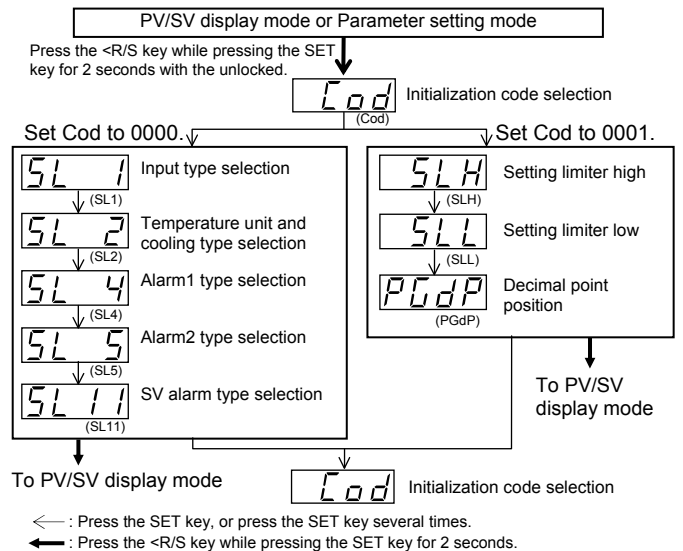

7.4 Input Type Selection (SL1)

When any parameter setting is changed in the Initialization mode, check all parameter set values in SV setting mode and Parameter setting mode.

Factory set value varies depending on the input type.

Set value	Input type	
0000	K	Thermocouple ¹ (TC)
0001	J	
0010	L	
0011	E	
0100	N	
0111	R	
1000	S	
1001	B ⁴	
1010	W5Re/W26Re ⁴	
1011	PL II	
0101	T	
0110	U	
1100	Pt100 Ω (JIS/IEC)	RTD ¹
1101	JPt100 Ω (JIS)	
1110	0 to 5 V DC	Voltage ¹
1110	0 to 10 V DC ²	
1111	1 to 5 V DC	
1110	0 to 20 mA DC	Current ^{1,3}
1111	4 to 20 mA DC	

¹ Any input change in TC&RTD group is possible. Any input change in Voltage & Current group except for 0 to 10 V DC input is possible. No input change between TC&RTD group and Voltage & Current group is possible.

² The input type of Z-1010 specification is fixed to 0 to 10 V DC due to the hardware difference.

³ For the current input specification, a resistor of 250 Ω must be connected between the input terminals.

⁴ W5Re/W26Re and B are not available with Z-1021 specification (Modbus communication).

Change Settings

Example: Change the input type from “K” to “J”

- Set “Cod” to 0000, and press the SET key. The display will go to SL1.

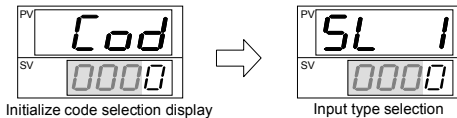

- Press the UP key to change the number to 1.



- Press the SET key to store the new set value. The display goes to the next parameter.

7.5 Temperature Unit and Cooling Type Selection (SL2)

Inappropriate settings may result in malfunction. Control type between Heat Only and Heat/Cool cannot be changed by this parameter.

Factory set value varies depending on the instrument specification.

Set value	Description	
	Temperature unit	Cooling type selection
0000	°C	Air cooling (A type) or Heat only type (F, D type)
0001	°F	Air cooling (A type) or Heat only type (F, D type)
0010	°C	Water cooling (W type)
0011	°F	Water cooling (W type)

Change Settings

Example: Change the temperature unit of the Heat only type from “°C (0000)” to “°F (0001)”

- Press the SET key until SL2 is displayed.
- Press the UP key to change the number to 1.

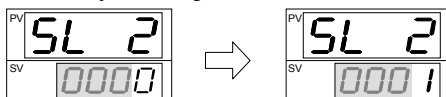

- Press the SET key to store the new set value. The display goes to the next parameter.

7.6 Alarm 1 [ALM1] Type Selection (SL4) Alarm 2 [ALM2] Type Selection (SL5)

If the alarm function is not provided with the instrument when shipped from the factory, no alarm output is available by changing SL4 and/or SL5.

SL4 is set to 0000 in the following cases.

- When the instrument does not have ALM1 output
- When Control loop break alarm (LBA) is provided and assigned to ALM1
- When the SV alarm is provided and assigned to ALM1

SL5 is set to 0000 in the following cases.

- When the instrument does not have ALM2 output
- When Control loop break alarm (LBA) is provided and assigned to ALM2
- When the SV alarm is provided and assigned to ALM2
- When the Heater break alarm (HBA) is provided
- When the instrument has Z-168 specification

Factory set value varies depending on the instrument specification.

Set value	Details of setting
0000	No alarm
0001	Deviation high alarm
0101	Deviation low alarm
0010	Deviation high/low alarm
0110	Band alarm
0011	Process high alarm
0111	Process low alarm
1001	Deviation high alarm with hold action *
1101	Deviation low alarm with hold action *
1010	Deviation high/low alarm with hold action *
1011	Process high alarm with hold action *
1111	Process low alarm with hold action *

* Hold action:

When Hold action is ON, the alarm action is suppressed at start-up or the control set value change until the measured value enters the non-alarm range.

Alarm action type

Both of the Alarm 1 and Alarm 2 outputs of this instrument are turned on when burnout occurs regardless of any of the following actions taken (high alarm, low alarm, etc.). In addition, when used for any purposes other than these alarms (event, etc.), specify the Z-124 specification (not to be forcibly turned on).

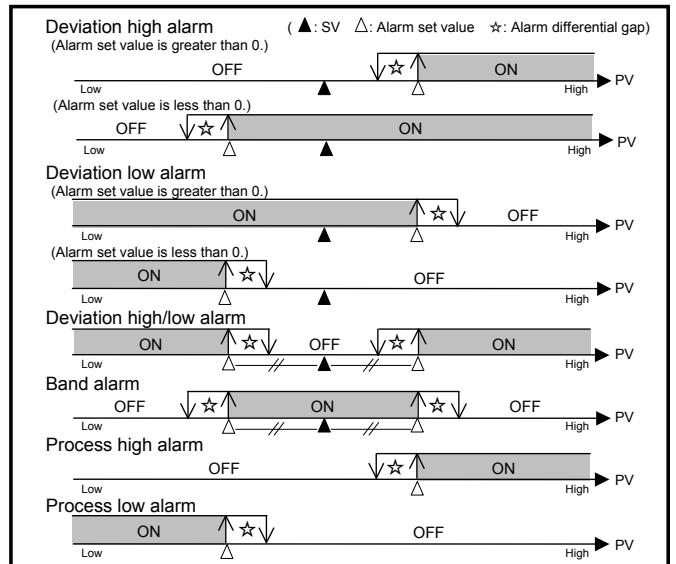

Change Settings

Example: Change the ALM1 type from “Deviation high alarm (0001)” to “Deviation low alarm (0101)”

- Press the SET key three times at SL1 until SL4 is displayed.
- Press the <R/S key to high-light the hundreds digit.
- Press the UP key to change the number to 1.

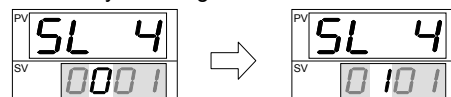

- Press the SET key to store the new set value. The display goes to the next parameter.

7.7 SV Alarm Type Selection (SL11)

For ALM1 setting, the first digit from the right is set to "0" in the following cases.

- When the instrument does not have ALM1 output.
- When the ALM1 output is used for Process/Deviation/Band alarm or Control loop break alarm (LBA).

For ALM2 setting, the third digit from the right is set to "0" in the following cases.

- When the instrument does not have ALM2 output.
- When the ALM1 output is used for Process/Deviation/Band alarm, Heater break alarm (HBA) or Control loop break alarm (LBA).
- When Z-168 is specified.

To make SV alarm setting effective, set SL4 to "0000" when using ALM1 for SV alarm, or set SL5 to "0000" when using ALM2 for SV alarm. SL4 and SL5 have priority to SL11 setting.

Factory set value varies depending on the instrument specification.

Alarm	Details of setting		
Alarm 1 [ALM1]	0	0	SV alarm not provided
	1	1	SV alarm provided
	0	0	SV high alarm
	1	1	SV low alarm
Alarm 2 [ALM2]	0	0	SV alarm not provided
	1	1	SV alarm provided
	0	0	SV high alarm
	1	1	SV low alarm

SV alarm action type

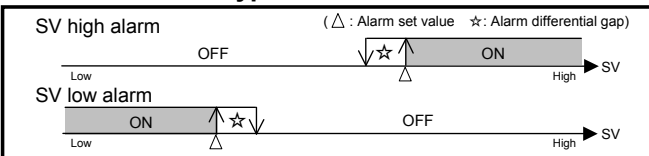

Change Settings

Example: Change the SV alarm type of the ALM1 from "SV high alarm (0001)" to "SV low alarm (0011)"

1. Press the SET key ten times at SL1 until SL11 is displayed.
2. Press the <R/S key to high-light the tens digit. Next, press the UP key to change the number to 1.

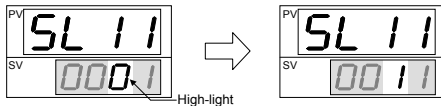

3. Press the SET key to store the new set value. The display goes to the initialize code parameter.

7.8 Setting Limiter High (SLH) Setting Limiter Low (SLL)

For voltage or current input, set scaling within the input range.

Refer to Input range table (P. 12)

Factory set value varies depending on the instrument specification.

Input type	Setting range	
	Setting limiter high	Setting limiter low
TC	K	SLL to 1372 °C SLL to 2502 °F 0 to SLH °C 0 to SLH °F
	J	SLL to 1200 °C SLL to 2192 °F 0 to SLH °C 0 to SLH °F
	R	SLL to 1769 °C 0 to SLH °C
	S	SLL to 3216 °F 0 to SLH °F
	B	SLL to 1820 °C SLL to 3308 °F 0 to SLH °C 0 to SLH °F
	E	SLL to 1000 °C SLL to 1832 °F 0 to SLH °C 0 to SLH °F
	N	SLL to 1300 °C SLL to 2372 °F 0 to SLH °C 0 to SLH °F
	T	SLL to 400.0 °C SLL to 752.0 °F -199.9 to SLH °C -199.9 to SLH °F
	W5Re/W26Re	SLL to 2320 °C SLL to 4208 °F 0 to SLH °C 0 to SLH °F
	PLII	SLL to 1390 °C SLL to 2534 °F 0 to SLH °C 0 to SLH °F

Factory set value varies depending on the instrument specification.

Input type	Setting range		
	Setting limiter high	Setting limiter low	
TC	U	SLL to 600.0 °C SLL to 999.9 °F -199.9 to SLH °C -199.9 to SLH °F	
	L	SLL to 800 °C SLL to 1600 °F 0 to SLH °C 0 to SLH °F	
RTD	Pt100	SLL to 649.0 °C SLL to 999.9 °F -199.9 to SLH °C -199.9 to SLH °F	
	JPt100		
Voltage	0 to 5 V DC	SLL to 9999 (Programmable range)	-1999 to SLH (Programmable range)
	0 to 10 V DC *		
	1 to 5 V DC		
Current	0 to 20 mA DC		
	4 to 20 mA DC		

* Z-1010 specification

Change Settings

Example: When the display range is scaled to 0.0 to 400.0 for a voltage input of 1 to 5 V DC.

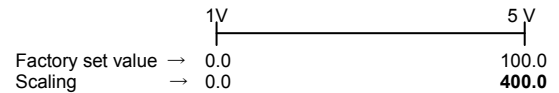

1. Set Cod to 0001, and press the SET key. The display will go to SLH.

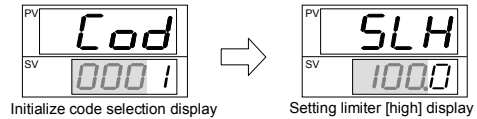

2. The high-lighted digit indicates which digit can be set. Press <R/S key to high-light the first digit from the left.



3. Press the UP key to change the number to 4.

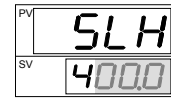

4. Press the SET key to store the new set value. The display goes to SLL.
5. Set SLL to 0.0.
6. Press the SET key to store the new set value. The display goes to the next parameter.

7.9 Decimal Point Position (PGdP)

Use to select a Decimal point position of the input range (voltage input and current input). PGdP is displayed only for voltage or current input.

Inappropriate settings may result in malfunction.

Set value	Description
0000	No decimal place (□□□□)
0001	One decimal place (□□□.□) [Factory set value]
0002	Two decimal places (□□.□□)
0003	Three decimal places (□.□□□)

Change Settings

Example: Change the Decimal point position from "One decimal place (0001)" to "No decimal place (0000)"

1. Press the SET key two times at SLH until PGdP is displayed.
2. Press the DOWN key to change the number to 0.

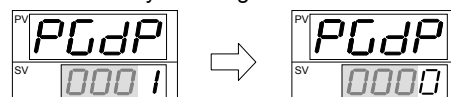

3. Press the SET key to store the new set value. The display goes to the next parameter.

8. ERROR DISPLAYS

■ Error display

Err	RAM failure (Incorrect set data write, etc.)	Turn off the power at once. If an error occurs after the power is turned on again, please contact RKC sales office or the agent.
------------	----------------------------------------------	----------------------------------------------------------------------------------------------------------------------------------

■ Over-scale and Underscale

Measured value (PV) [Flashing]	PV is outside of input range.	WARNING To prevent electric shock, always turn off the power before replacing the sensor. Check Input type, Input range and connecting state of sensor. Confirm that the sensor or wire is not broken.
0000 [Flashing]	Over-scale: PV is above the high input display range limit.	
UUUU [Flashing]	Underscale: PV is below the low input display range limit.	

9. INPUT RANGE TABLE

Input type	Model code	Input type	Model code	Input type	Model code	Input type	Model code	Input type	Model code					
K	0 to 200 °C	K 01	J	0 to 800 °F	J A1	N	0 to 1200 °C	N 01	U	*2 -199.9 to +100.0 °C	U 02	Pt100	-100.0 to +100.0 °F	D A4
	0 to 400 °C	K 02		0 to 1600 °F	J A2		0 to 1300 °C	N 02		0.0 to 400.0 °C	U 03		-100.0 to +300.0 °F	D A5
	0 to 600 °C	K 03		0 to 2192 °F	J A3		0 to 2300 °F	N A1		-199.9 to +999.9 °F	U A1		0.0 to 100.0 °F	D A6
	0 to 800 °C	K 04		0 to 400 °F	J A6		0 to 2372 °F	N A2		-100.0 to +200.0 °F	U A2		0.0 to 200.0 °F	D A7
	0 to 1000 °C	K 05		0 to 300 °F	J A7		*2 -199.9 to +400.0 °C	T 01		0.0 to 999.9 °F	U A3		0.0 to 400.0 °F	D A8
	0 to 1200 °C	K 06		*1 0 to 1600 °C	R 01		*2 -199.9 to +100.0 °C	T 02		0 to 400 °C	L 01		0.0 to 500.0 °F	D A9
	0 to 1372 °C	K 07	*1 0 to 1769 °C	R 02	-100.0 to +200.0 °C	T 03	0 to 800 °C	L 02	-199.9 to +649.0 °C	P 01				
	0 to 100 °C	K 13	*1 0 to 1350 °C	R 04	0.0 to 350.0 °C	T 04	0 to 800 °F	L A1	-199.9 to +200.0 °C	P 02				
	0 to 300 °C	K 14	*1 0 to 3200 °F	R A1	*2 -199.9 to +752.0 °F	T A1	0 to 1600 °F	L A2	-100.0 to +50.0 °C	P 03				
	0 to 450 °C	K 17	*1 0 to 3216 °F	R A2	-100.0 to +200.0 °F	T A2	-199.9 to +649.0 °C	D 01	-100.0 to +100.0 °C	P 04				
	0 to 500 °C	K 20	*1 0 to 1600 °C	S 01	-100.0 to +400.0 °F	T A3	-199.9 to +200.0 °C	D 02	-100.0 to +200.0 °C	P 05				
	0 to 800 °F	K A1	*1 0 to 1769 °C	S 02	0.0 to 450.0 °F	T A4	-100.0 to +50.0 °C	D 03	0.0 to 50.0 °C	P 06				
	0 to 1600 °F	K A2	*1 0 to 3200 °F	S A1	0.0 to 752.0 °F	T A5	-100.0 to +100.0 °C	D 04	0.0 to 100.0 °C	P 07				
	0 to 2502 °F	K A3	*1 0 to 3216 °F	S A2	W5Re/0 to 2000 °C	W 01	-100.0 to +200.0 °C	D 05	0.0 to 200.0 °C	P 08				
20 to 70 °F	K A9	400 to 1800 °C	B 01	W26Re/0 to 2320 °C	W 02	0.0 to 50.0 °C	D 06	0.0 to 300.0 °C	P 09					
J	0 to 200 °C	J 01	*1 0 to 1820 °C	B 02	0 to 4000 °F	W A1	0.0 to 100.0 °C	D 07	0.0 to 500.0 °C	P 10				
	0 to 400 °C	J 02	B (*3)	800 to 3200 °F	B A1	0 to 1300 °C	A 01	0.0 to 200.0 °C	D 08	0 to 5 V DC	4 01			
	0 to 600 °C	J 03		0 to 3308 °F	B A2	0 to 1390 °C	A 02	0.0 to 300.0 °C	D 09	0 to 10 V DC **	5 01			
	0 to 800 °C	J 04	0 to 800 °C	E 01	0 to 1200 °C	A 03	0.0 to 500.0 °C	D 10	1 to 5 V DC	6 01				
	0 to 1000 °C	J 05	0 to 1000 °C	E 02	0 to 2400 °F	A A1	-199.9 to +999.9 °F	D A1	100.0	7 01				
	0 to 1200 °C	J 06	0 to 1600 °F	E A1	0 to 2534 °F	A A2	-199.9 to +400.0 °F	D A2	4 to 20 mA DC	8 01				
	0 to 450 °C	J 10	0 to 1832 °F	E A2	U *2 -199.9 to +600.0 °C	U 01	-199.9 to +200.0 °F	D A3						

*1 0 to 399 °C / 0 to 799 °F. Accuracy is not guaranteed.

*2 -199.9 to -100.0 °C / -199.9 to -158.0 °F. Accuracy is not guaranteed.

*3 This input type can not be selected in the Z-1021 specification.

**Z-1010 specification

10. REMOVING THE INTERNAL ASSEMBLY

Usually, this instrument is not necessary to remove the internal assembly from the case. When removing the internal assembly without disconnecting the external wiring, take the following steps.

⚠ **WARNING**

- To prevent electric shock or instrument failure, only qualified personnel should be allowed to pull out the internal assembly.
- To prevent electric shock or instrument failure, always turn off the power before pulling out the internal assembly.
- To prevent injury or instrument failure, do not touch the internal printed wiring board.

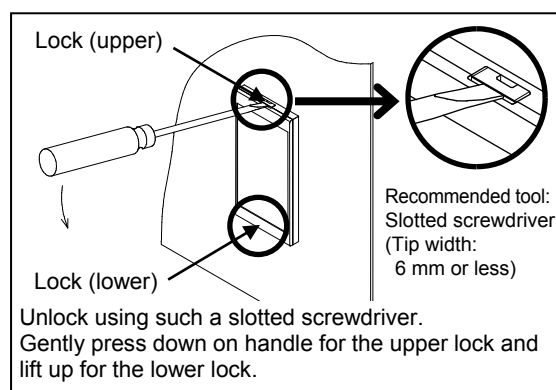

- Apply pressure very carefully when removing internal assembly to avoid damage to the frame.
- To conform to IEC61010-1 requirements for protection from electric shock, the internal assembly of this instrument can only be removed with an appropriate tool.
- Unlocking points (marked with "O") depend on the model as follows:

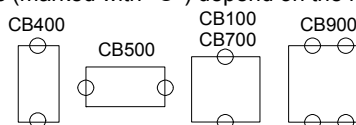

The first edition: JAN. 2012 [IMQ00]