

---

---

---

---

---

---

*Digital Controller*

***FB100***

***Instruction Manual***

- Modbus is a registered trademark of Schneider Electric.
- Company names and product names used in this manual are the trademarks or registered trademarks of the respective companies.

Thank you for purchasing this RKC product. In order to achieve maximum performance and ensure proper operation of your new instrument, carefully read all the instructions in this manual. Please place the manual in a convenient location for easy reference.

## NOTICE

- This manual assumes that the reader has a fundamental knowledge of the principles of electricity, process control, computer technology and communications.
- The figures, diagrams and numeric values used in this manual are only for purpose of illustration.
- RKC is not responsible for any damage or injury that is caused as a result of using this instrument, instrument failure or indirect damage.
- RKC is not responsible for any damage and/or injury resulting from the use of instruments made by imitating this instrument.
- Periodic maintenance is required for safe and proper operation of this instrument. Some components have a limited service life, or characteristics that change over time.
- Every effort has been made to ensure accuracy of all information contained herein. RKC makes no warranty expressed or implied, with respect to the accuracy of the information. The information in this manual is subject to change without prior notice.
- No portion of this document may be reprinted, modified, copied, transmitted, digitized, stored, processed or retrieved through any mechanical, electronic, optical or other means without prior written approval from RKC.



### WARNING

- An external protection device must be installed if failure of this instrument could result in damage to the instrument, equipment or injury to personnel.
- All wiring must be completed before power is turned on to prevent electric shock, fire or damage to instrument and equipment.
- This instrument must be used in accordance with the specifications to prevent fire or damage to instrument and equipment.
- This instrument is not intended for use in locations subject to flammable or explosive gases.
- Do not touch high-voltage connections such as power supply terminals, etc. to avoid electric shock.
- RKC is not responsible if this instrument is repaired, modified or disassembled by other than factory-approved personnel. Malfunction can occur and warranty is void under these conditions.

## **CAUTION**

- This product is intended for use with industrial machines, test and measuring equipment. (It is not designed for use with medical equipment and nuclear energy.)
- This is a Class A instrument. In a domestic environment, this instrument may cause radio interference, in which case the user may be required to take additional measures.
- This instrument is protected from electric shock by reinforced insulation. Provide reinforced insulation between the wire for the input signal and the wires for instrument power supply, source of power and loads.
- Be sure to provide an appropriate surge control circuit respectively for the following:
  - If input/output or signal lines within the building are longer than 30 meters.
  - If input/output or signal lines leave the building, regardless the length.
- This instrument is designed for installation in an enclosed instrumentation panel. All high-voltage connections such as power supply terminals must be enclosed in the instrumentation panel to avoid electric shock by operating personnel.
- All precautions described in this manual should be taken to avoid damage to the instrument or equipment.
- All wiring must be in accordance with local codes and regulations.
- All wiring must be completed before power is turned on to prevent electric shock, instrument failure, or incorrect action.

The power must be turned off before repairing work for input break and output failure including replacement of sensor, contactor or SSR, and all wiring must be completed before power is turned on again.
- To prevent instrument damage or failure, protect the power line and the input/output lines from high currents with a protection device such as fuse, circuit breaker, etc.
- Prevent metal fragments or lead wire scraps from falling inside instrument case to avoid electric shock, fire or malfunction.
- Tighten each terminal screw to the specified torque found in the manual to avoid electric shock, fire or malfunction.
- For proper operation of this instrument, provide adequate ventilation for heat dispensation.
- Do not connect wires to unused terminals as this will interfere with proper operation of the instrument.
- Turn off the power supply before cleaning the instrument.
- Do not use a volatile solvent such as paint thinner to clean the instrument. Deformation or discoloration will occur. Use a soft, dry cloth to remove stains from the instrument.
- To avoid damage to instrument display, do not rub with an abrasive material or push front panel with a hard object.
- Do not connect modular connectors to telephone line.
- When high alarm with hold action/re-hold action is used for Event function, alarm does not turn on while hold action is in operation. Take measures to prevent overheating which may occur if the control device fails.

### **FOR PROPER DISPOSAL**

- When disposing of each part used for this instrument, always follows the procedure for disposing of industrial wastes stipulated by the respective local community.

# SYMBOLS

## Safety Symbols:

**WARNING** : This mark indicates precautions that must be taken if there is danger of electric shock, fire, etc., which could result in loss of life or injury.

**CAUTION** : This mark indicates that if these precautions and operating procedures are not taken, damage to the instrument may result.



: This mark indicates that all precautions should be taken for safe usage.



: This mark indicates important information on installation, handling and operating procedures.



: This mark indicates supplemental information on installation, handling and operating procedures.



: This mark indicates where additional information may be located.

## Character Symbols:

0	1	2	3	4	5	6	7	8	9	Minus	Period
0	1	2	3	4	5	6	7	8	9	-	.

A	B (b)	C	c	D (d)	E	F	G	H	I	J	K
A	b	C	c	d	E	F	G	H	I	J	K

L	M	N (n)	O (o)	P	Q (q)	R (r)	S	T	t	U	u
L	M	N	O	P	Q	R	S	T	t	U	u

V	W	X	Y	Z	Degree	/	Dash
V	W	X	Y	Z	°	-	'

	Dim lighting
	Bright lighting
	Flashing

## DOCUMENT CONFIGURATION

There are six manuals pertaining to this product. Please be sure to read all manuals specific to your application requirements. If you do not have a necessary manual, please contact RKC sales office, the agent, or download from the official RKC website.

The following manuals can be downloaded from the official RKC website:

[http://www.rkcinst.com/english/manual\\_load.htm](http://www.rkcinst.com/english/manual_load.htm).

Manual	Manual Number	Remarks
FB100 Installation Manual	IMR01W12-E□	This manual is enclosed with instrument. This manual explains the mounting and wiring, front panel name, and the operation mode outline.
FB100 Quick Operation Manual	IMR01W13-E□	This manual is enclosed with instrument. This manual explains the basic key operation, mode menu, and data setting.
FB100 Parameter List	IMR01W14-E□	This manual is enclosed with instrument. This list is a compilation of the parameter data of each mode.
FB100 Communication Quick Manual	IMR01W15-E□	This manual is enclosed with instrument. (Only FB100 provided with the communication function) This manual explains the connection method with host computer, communication parameters, and communication data (except for parameters in Engineering Mode).
<b>FB100 Instruction Manual</b>	<b>IMR01W16-E7</b>	This Manual. This manual explains the method of the mounting and wiring, the operation of various functions, and troubleshooting.
FB100/FB400/FB900 Communication Instruction Manual *	IMR01W04-E□	This manual explains RKC communication protocol (ANSI X3.28-1976), Modbus, and relating to the communication parameters setting.

\* Sold separately



Read this manual carefully before operating the instrument. Please place the manual in a convenient location for easy reference.

# CONTENTS

---

	Page
<b>1. OUTLINE .....</b>	<b>1-1</b>
1.1 Features .....	1-2
1.2 Checking the Product .....	1-3
1.3 Model Code .....	1-4
■ Suffix code.....	1-4
■ Quick start code 2 (Initial setting code) .....	1-6
1.4 Parts Description .....	1-8
1.5 Input/Output Functions .....	1-11
<b>2. HANDLING PROCEDURE TO OPERATION .....</b>	<b>2-1</b>
<b>3. MOUNTING .....</b>	<b>3-1</b>
3.1 Mounting Cautions.....	3-2
3.2 Dimensions.....	3-3
3.3 Procedures of Mounting and Removing .....	3-4
■ Mounting procedures.....	3-4
■ Removing procedures .....	3-4
<b>4. WIRING .....</b>	<b>4-1</b>
4.1 Wiring Cautions .....	4-2
4.2 Terminal Layout.....	4-4
■ Isolations of input and output.....	4-5
4.3 Wiring of Each Terminal .....	4-6
4.3.1 Power supply.....	4-6
4.3.2 Output 1 (OUT1)/Output 2 (OUT2).....	4-7
4.3.3 Digital output 1, 2 (DO1, DO2) .....	4-9
4.3.4 Measured input (Thermocouple/RTD/Voltage/Current) .....	4-9
4.3.5 Optional.....	4-10
■ Optional function: A [Digital input (5 points)].....	4-10
■ Optional function: B [Digital input (2 points) + Remote setting input (1 point)] .....	4-11
■ Optional function: C [Digital input (2 points) + Feedback resistance input (1 point)] .....	4-12
■ Optional function: D [Digital input (2 points) + Current transformer input (2 points)] .....	4-13
■ Optional function: E [Communication (1 point) + Digital input (3 points) .....	4-14
■ Optional function: F [Communication (1 point) + Digital input (1 point) + Current transformer input (1 point)] .....	4-15
■ Optional function: G [Communication (2 points)] .....	4-16

	Page
■ Optional function: H [Communication (1 point) + Current transformer input (2 points)] .....	4-17
■ Optional function: J [Communication (1 point) + Digital input (1 point) + Remote setting input (1 point)] .....	4-18
■ Optional function: 3, 4, 5, 6, 7, 8 [Digital input (1 point) + Transmission output (1 point) + Remote setting input (1 point)] .....	4-20

## **5. OPERATION MENU AND BASIC OPERATION .....5-1**

5.1 Operation Menu .....	5-2
■ Input type and input range display .....	5-3
5.2 Basic Operation .....	5-4
5.2.1 Scrolling through parameters .....	5-4
■ SV setting & monitor mode .....	5-4
■ Parameter setting mode, Setup setting mode .....	5-6
■ Operation mode .....	5-7
■ Engineering mode .....	5-8
5.2.2 Changing set value (SV) .....	5-9
5.2.3 Operation of the direct key .....	5-10
5.2.4 Data lock function .....	5-11

## **6. OPERATION .....6-1**

6.1 Operating Precautions .....	6-2
6.2 Monitoring Display in Operation .....	6-3
■ When the Direct key type is other than Monitor .....	6-3
■ When the Direct key type is Monitor .....	6-4
6.3 Operating Setting .....	6-5
6.3.1 Set the Set value (SV) .....	6-5
6.3.2 Set the Event set value (alarm set value) .....	6-7
6.3.3 Autotuning (AT) start .....	6-8
■ To manually set PID values .....	6-9
6.4 RUN/STOP Transfer .....	6-11
■ RUN/STOP transfer by Front key operation .....	6-11
■ RUN/STOP transfer by Direct key operation .....	6-12
■ RUN/STOP transfer by Digital input (DI) [optional] .....	6-13
6.5 Autotuning (AT) .....	6-15
■ Caution for using the Autotuning (AT) .....	6-15
■ Requirements for Autotuning (AT) start .....	6-15



	Page
■ Requirements for Autotuning (AT) cancellation.....	6-15
■ Autotuning (AT) start/stop operation.....	6-16
6.6 Startup Tuning (ST) .....	6-18
■ Caution for using the Startup tuning (ST) .....	6-18
■ Requirements for Startup tuning (ST) start.....	6-19
■ Requirements for Startup tuning (ST) cancellation.....	6-19
■ Startup tuning (ST) setting.....	6-20
6.7 Auto/Manual Transfer .....	6-23
■ Auto/Manual transfer by Front key operation .....	6-24
■ Auto/Manual transfer by Direct key operation .....	6-25
■ Auto/Manual transfer by Digital input (DI) [optional].....	6-26
■ Procedure for setting the Manipulated output value (MV) in Manual mode.....	6-28
6.8 Remote/Local Transfer .....	6-29
■ Remote/Local transfer by Front key operation .....	6-29
■ Remote/Local transfer by Direct key operation .....	6-30
■ Remote/Local transfer by Digital input (DI) [optional].....	6-31
6.9 Control Area Transfer .....	6-33
■ Control area transfer by Front key operation.....	6-34
■ Control area transfer by Direct key operation.....	6-35
■ Control area transfer by Digital input (DI) [optional] .....	6-36
■ Control area transfer by Area soak time (Ramp/Soak Control) .....	6-38
6.10 Interlock Release.....	6-39
■ Interlock release method by Front key operation .....	6-40
■ Interlock release method by Digital input (DI) [optional].....	6-40
6.11 Start Action at Recovering Power Failure .....	6-42
■ Hot/Cold start selection .....	6-42
■ Start determination point .....	6-42
6.12 Position Proportioning PID Control.....	6-43
■ Setting flowchart.....	6-45
■ Setting procedures .....	6-47
6.13 Ramp/Soak Control .....	6-52
■ Operation flowchart .....	6-53
■ Settings before operation .....	6-54
■ Operation procedures.....	6-56
6.14 Group Operation by the Intercontroller Communication .....	6-61
6.14.1 Wiring method of the Intercontroller communication.....	6-61
6.14.2 Common setting of the Intercontroller communication.....	6-62
6.14.3 Group RUN/STOP function.....	6-64
■ Operation flowchart.....	6-64
■ Requirements for Group RUN/STOP.....	6-65
■ Group RUN/STOP operation and states.....	6-65

	Page
■ Settings before operation.....	6-66
■ Usage example.....	6-69
6.14.4 Automatic temperature rise function (with learning function) .....	6-72
■ Requirements for automatic temperature rise learning start.....	6-73
■ Requirements for automatic temperature rise learning cancellation.....	6-73
■ Requirements for automatic temperature rise start .....	6-74
■ Requirements for automatic temperature rise cancellation .....	6-74
■ Operation flowchart.....	6-75
■ Settings before operation.....	6-76
■ Operation procedures .....	6-79
6.14.5 Cascade control function.....	6-81
■ Operation flowchart.....	6-82
■ Settings before operation.....	6-83
■ Adjustment after control starting .....	6-85
■ Operation procedures .....	6-88
6.14.6 Ratio setting function.....	6-89
■ Operation flowchart.....	6-90
■ Settings before operation.....	6-91
■ Adjustment after control starting .....	6-93
■ Operation procedures .....	6-96
■ Usage example.....	6-97

## **7. PARAMETER DESCRIPTION ..... 7-1**

7.1 SV Setting & Monitor Mode.....	7-2
7.1.1 Display sequence (When the Direct key type is other than Monitor) .....	7-2
7.1.2 Display sequence (When the Direct key type is Monitor).....	7-3
7.1.3 Monitor and setting item.....	7-4
7.2 Operation Mode .....	7-14
7.2.1 Display sequence.....	7-14
7.2.2 Operation item.....	7-15
7.3 Parameter Setting Mode.....	7-22
7.3.1 Display sequence.....	7-23
7.3.2 Parameter setting item .....	7-24
7.4 Setup Setting Mode .....	7-37
7.4.1 Display sequence.....	7-37
7.4.2 Setup setting item .....	7-38
7.5 Engineering Mode .....	7-52
7.5.1 Display sequence.....	7-52
7.5.2 Precaution against parameter change .....	7-58

	Page
7.5.3 Engineering setting item.....	7-65
Function block 10 (F10.) [Display].....	7-65
Function block 11 (F11.) [Direct key].....	7-70
Function block 21 (F21.) [Input].....	7-71
Function block 22 (F22.) [Remote setting input type].....	7-79
Function block 23 (F23.) [Digital input assignment] .....	7-80
Function block 30 (F30.) [Output].....	7-81
Function block 33 (F33.) [Transmission output] .....	7-86
Function block 41 (F41.) [Event 1] .....	7-88
Function block 42 (F42.) [Event 2] .....	7-97
Function block 43 (F43.) [Event 3] .....	7-101
Function block 44 (F44.) [Event 4] .....	7-105
Function block 45 (F45.) [Heater break alarm 1].....	7-112
Function block 46 (F46.) [Heater break alarm 2].....	7-116
Function block 50 (F50.) [Hot/Cold start etc.].....	7-119
Function block 51 (F51.) [Control 1] .....	7-125
Function block 52 (F52.) [Control 2] .....	7-140
Function block 53 (F53.) [Position proportioning PID control] .....	7-152
Function block 54 (F54.) [Startup tuning] .....	7-157
Function block 55 (F55.) [Group/Automatic temperature rise] .....	7-159
Function block 60 (F60.) [Communication protocol].....	7-162
Function block 70 (F70.) [Time unit].....	7-163
Function block 71 (F71.) [Setting limiter].....	7-164
Function block 91 (F91.) [Others].....	7-165

## **8. TROUBLESHOOTING .....8-1**

8.1 Error Display.....	8-2
■ Display when input error occurs .....	8-2
■ Self-diagnostic error .....	8-3
8.2 Solutions for Problems .....	8-4
■ Display.....	8-5
■ Control.....	8-6
■ Operation.....	8-8
■ Event function.....	8-9
■ Heater break alarm (HBA).....	8-10

## **9. SPECIFICATIONS .....9-1**

■ Measured input.....	9-2
■ Remote setting (RS) input [optional].....	9-3
■ Current transformer (CT) input [optional].....	9-4

	Page
■ Feedback resistance (FBR) input [optional].....	9-4
■ Digital input (DI) [optional] .....	9-5
■ Output (OUT1, OUT2) .....	9-5
■ Digital output (DO1, DO2).....	9-6
■ Transmission output (AO) [optional] .....	9-6
■ Performance (at the ambient temperature 23 ±2 °C).....	9-7
■ Control .....	9-8
■ Brilliant II PID control .....	9-8
■ Brilliant II Heat/Cool PID control .....	9-9
■ Brilliant II Position proportioning PID control without FBR .....	9-10
■ Event function [optional] .....	9-11
■ Control loop break alarm (LBA) [optional].....	9-12
■ Heater break alarm (HBA) [time-proportional control output (optional)] .....	9-12
■ Heater break alarm (HBA) [continuous control output (optional)] .....	9-12
■ Multi-memory area function [optional].....	9-12
■ Loader communication .....	9-13
■ Communication [optional] .....	9-13
■ Intercontroller communication function [optional] .....	9-14
■ Self-diagnostic function.....	9-15
■ Power.....	9-15
■ General specifications .....	9-16
■ Standard .....	9-17

## **APPENDIX ..... A-1**

A. Removing the Internal Assembly.....	A-2
B. Replacing the Waterproof/Dustproof Rubber Packing.....	A-4
C. Current Transformer (CT) Dimensions.....	A-6
D. Memory Area Data List .....	A-7
E. Parameter List.....	A-8
F. Seal [for Unit and Direct key] (accessory attached).....	A-24

## **INDEX..... B-1**

Alphabetical Order.....	B-2
Character Order.....	B-5

Revisions

# OUTLINE



1.1 Features .....	1-2
1.2 Checking the Product .....	1-3
1.3 Model Code .....	1-4
1.4 Parts Description .....	1-8
1.5 Input/Output Functions .....	1-11

# 1.1 Features

---

This chapter describes features, package contents and model code, etc. The digital controller of this high performance type has the following features:

■ **Panel space saving: 74 mm depth**

■ **Selectable sampling time among 50ms, 100ms, and 250 ms.**

Selectable sampling time makes the FB100 suitable for any application ranging from pressure control requiring fast response to precise control requiring highest resolution. (Factory setting: 100 ms)

■ **Selectable PID control algorithm**

PID control algorithm is selectable in the FB100 to achieve the most precise control for various applications.

PV derivative PID : suitable for fixed setpoint control (Factory setting)

Deviation derivative PID : suitable for ramp control using ramp-to-setpoint function and cascade control.

■ **Advanced Heat/Cool PID algorithm with Undershoot Suppression**

■ **Startup tuning to eliminate time for autotuning**

■ **Mode switching can be performed directly (Direct key)**

Control RUN/STOP, Auto/Manual, Remote/Local, Memory area, or monitor transfer can be selected.

(Factory set value: Auto/Manual transfer)

■ **Up to 8 recipes (multi-memory area) or Ramp/Soak control**

FB100 can store up to 8 sets of control parameters. Ramp/Soak control is available by using the memory area function.

■ **Easy maintenance**

The internal assembly of the FB100 can be removed from the front.

■ **NEMA4X and IP66 waterproof and dustproof protection for severe environments. (standard)**

■ **Two communication ports (optional)**

- Host communication can be performed with a host computer or host device such as an operation panel. (Communication 1)

- Group operation such as cascade control and ratio setting is possible using only Intercontroller communication; it is not necessary to use communication with a host computer or analog signals such as remote setting input and transmission output.

(Communication 1 or Communication 2)

■ **Easy-setup and Data Monitoring via a standard data port**

The FB100 have the loader port (provided as standard) to connect to a PC USB port with Windows 2000/XP/Vista/7.

The standard port allows setup and data logging to be managed by the PC. The FB100 is recognized as an external device on the PC.

[The communication tool (WinUCI, PROTEM2) can be downloaded from the RKC official website:

[http://www.rkcinst.com/.](http://www.rkcinst.com/)]

## 1.2 Checking the Product

Before using this product, check each of the following:

- Model code
- Check that there are no scratches or breakage in external appearance (case, front panel, or terminal, etc.)
- Check that all of the items delivered are complete. (Refer to below)

Accessories	Q'TY	Remarks	
<input type="checkbox"/> Instrument	1	_____	
<input type="checkbox"/> Mounting brackets (with screw)	2	_____	
<input type="checkbox"/> Seal (SAP-379)	1	_____	
<input type="checkbox"/> Case rubber packing (KRB100-39)	1	For waterproof/dustproof	
<input type="checkbox"/> Installation Manual (IMR01W12-E□)	1	Enclosed with instrument	
<input type="checkbox"/> Quick Operation Manual (IMR01W13-E□)	1	Enclosed with instrument	
<input type="checkbox"/> Parameter List (IMR01W14-E□)	1	Enclosed with instrument	
<input type="checkbox"/> Communication Quick Manual (IMR01W15-E□)	1	Enclosed with instrument (with communication function )	
<input type="checkbox"/> Instruction Manual (IMR01W16-E7)	1	This manual (sold separately)	This manual can be downloaded from the official RKC website: <a href="http://www.rkcinst.com/english/&lt;br/&gt;manual_load.htm">http://www.rkcinst.com/english/ manual_load.htm</a> .
<input type="checkbox"/> Communication Instruction Manual (IMR01W04-E□)	1	Sold separately	
<input type="checkbox"/> Terminal cover (KCA100-517)	Depending on the order quantity	Optional (sold separately)	
<input type="checkbox"/> Front cover (KRB100-36A)	Depending on the order quantity	Optional (sold separately)	
<input type="checkbox"/> Current transformer (CTL-6-P-N [for 0 to 30 A] or CTL-12-S56-10L-N [for 0 to 100 A])	Depending on the order quantity	Optional (sold separately)	

 If any of the products are missing, damaged, or if your manual is incomplete, please contact RKC sales office or the agent.

# 1.3 Model Code

Check that the product received is correctly specified by referring to the following model code list:  
 If the product is not identical to the specifications, please contact RKC sales office or the agent.

■ Suffix code

**FB100**—□ □—□ \* □ / □ □—□ □□□ /Y  
 (1) (2) (3) (4) (5) (6) (7) (8) (9)

Specifications		Suffix code								
		Hardware coding only						Quick start code 1		
		(1)	(2)	(3)	(4)	(5)	(6)	(7)	(8)	(9)
Output 1 (OUT1)	Relay contact output	M								
	Voltage pulse output	V								
	Voltage output (0 to 5 V DC)	4								
	Voltage output (0 to 10 V DC)	5								
	Voltage output (1 to 5 V DC)	6								
	Current output (0 to 20 mA DC)	7								
	Current output (4 to 20 mA DC)	8								
	Triac output	T								
	Open collector output	D								
Output 2 (OUT2)	None	N								
	Relay contact output	M								
	Voltage pulse output	V								
	Voltage output (0 to 5 V DC)	4								
	Voltage output (0 to 10 V DC)	5								
	Voltage output (1 to 5 V DC)	6								
	Current output (0 to 20 mA DC)	7								
	Current output (4 to 20 mA DC)	8								
	Triac output	T								
Open collector output	D									
Power supply voltage	24 V AC/DC			3						
	100 to 240 V AC			4						
Optional function	None				N					
	Digital input (5 points)				A					
	Digital input (2 points) + Remote setting input				B					
	Digital input (2 points) + Feedback resistance input				C					
	Digital input (2 points) + CT input (2 points)				D					
	Digital input (3 points) + Communication (1 point)				E					
	Digital input (1 point) + Communication (1 point) + CT input (1 point)				F					
	Communication (2 points) *				G					
	Communication (1 point) + CT input (2 points)				H					
	Communication (1 point) + Digital input (1 point) + Remote setting input				J					
	Digital input (1 point) + Remote setting input + Transmission output [Voltage output (0 to 1 V DC)]				3					
	Digital input (1 point) + Remote setting input + Transmission output [Voltage output (0 to 5 V DC)]				4					
	Digital input (1 point) + Remote setting input + Transmission output [Voltage output (0 to 10 V DC)]				5					
Digital input (1 point) + Remote setting input + Transmission output [Voltage output (1 to 5 V DC)]				6						
Digital input (1 point) + Remote setting input + Transmission output [Current output (0 to 20 mA DC)]				7						
Digital input (1 point) + Remote setting input + Transmission output [Current output (4 to 20 mA DC)]				8						
Case color	White case				N					
	Black case				A					
Quick start code	No quick start code (Configured to factory set value)					N				
	Specify quick start code 1					1				
	Specify quick start code 1 and 2 (Refer to page 1-6)					2				
Control Method [Quick start code 1]	Quick start code 1 is not specified						No code			
	PID control with AT (Reverse action)						F			
	PID control with AT (Direct action)						D			
	Heat/Cool PID control with AT						G			
	Heat/Cool PID control with AT (for Extruder [air cooling])						A			
	Heat/Cool PID control with AT (for Extruder [water cooling])						W			
	Position proportioning PID control without FBR (Reverse action)						Z			
	Position proportioning PID control without FBR (Direct action)						C			
Measured input and Range [Quick start code 1]	Quick start code 1 is not specified							No code		
	Refer to Range Code Table.							□□□		
Instrument specification	Version symbol									Y

\* When the optional function code "G" is selected, the factory set value of Communication 2 becomes Intercontroller communication.



## ● Range Code Table

[Thermocouple (TC) input, RTD input]

Type	Code	Measured range	Code	Measured range
K	K35	-200.0 to +400.0 °C	KC4	-328.0 to +400.0 °F
	K40	-200.0 to +800.0 °C	KC6	-250.0 to +800.0 °F
	K41	-200 to +1372 °C	KC5	-328 to +2502 °F
	K09	0.0 to 400.0 °C	KA4	0.0 to 800.0 °F
	K10	0.0 to 800.0 °C	KA1	0 to 800 °F
	K14	0 to 300 °C	KA2	0 to 1600 °F
	K02	0 to 400 °C		
	K04	0 to 800 °C		
	J	J27	-200.0 to +400.0 °C	JC6
J32		-200.0 to +800.0 °C	JC7	-200.0 to +700.0 °F
J15		-200 to +1200 °C	JB9	-328 to +2192 °F
J08		0.0 to 400.0 °C	JB6	0.0 to 800.0 °F
J09		0.0 to 800.0 °C	JA1	0 to 800 °F
J02		0 to 400 °C	JA2	0 to 1600 °F
J04		0 to 800 °C		
T	T19	-200.0 to +400.0 °C	TC2	-328.0 to +752.0 °F
E	E21	-200.0 to +700.0 °C	EA9	-328.0 to +1292.0 °F
	E06	-200 to +1000 °C	EB1	-328 to +1832 °F
S	S06	-50 to +1768 °C	SA7	-58 to +3214 °F
R	R07	-50 to +1768 °C	RA7	-58 to +3214 °F
B	B03	0 to 1800 °C	BB2	0 to 3272 °F
N	N02	0 to 1300 °C	NA7	0 to 3272 °F
PLII	A02	0 to 1390 °C	AA2	0 to 2534 °F
W5Re/W26Re	W03	0 to 2300 °C	WA2	0 to 4200 °F
U	U04	0.0 to 600.0 °C	UB2	32.0 to 1112.0 °F
L	L04	0.0 to 900.0 °C	LA9	32.0 to 1652.0 °F
Pt100	D34	-100.00 to +100.00 °C	DD1	-200.0 to +200.0 °F
	D21	-200.0 to +200.0 °C	DC8	-199.99 to +199.99 °F
	D35	-200.0 to +850.0 °C	DC9	-328.0 to +1562.0 °F
JPt100	P29	-100.00 to +100.00 °C	PC8	-199.99 to +199.99 °F
	P30	-200.0 to +640.0 °C	PC9	-328.0 to +1184.0 °F
			PD1	-200.0 to +200.0 °F

[Voltage input, Current input]

Type	Code	Measured range
0 to 10 mV DC	101	Programmable range -19999 to +19999 [The decimal point position is selectable] (Factory set value: 0.0 to 100.0)
0 to 100 mV DC	201	
0 to 1 V DC	301	
0 to 5 V DC	401	
0 to 10 V DC	501	
1 to 5 V DC	601	
0 to 20 mA DC	701	
4 to 20 mA DC	801	
-100 to +100 mV DC	901	
-1 to +1 V DC	902	
-10 to +10 mV DC	903	

■ Quick start code 2 (Initial setting code)

Quick start code 2 tells the factory to ship with each parameter preset to the values detailed as specified by the customer. Quick start code is not necessarily specified when ordering, unless the preset is requested. These parameters are software selectable items and can be re-programmed in the field via the manual.

□□ □□ □-□ □ □ □-□ □  
 (1) (2) (3) (4) (5) (6) (7) (8) (9)

Specifications		Quick start code 2 (Initial setting code)							
		(1)	(2)	(3)	(4)	(5)	(6)	(7)	(8)
Output assignment	OUT1, OUT2, DO1, DO2 (Refer to Output Assignment Code Table)	□□							
Digital input assignment	DI1 to DI5 (Refer to Digital Input Assignment Code Table)	□□							
Remote setting input	None		N						
	Voltage input (0 to 10 mV DC)		1						
	Voltage input (0 to 100 mV DC)		2						
	Voltage input (0 to 1 V DC)		3						
	Voltage input (0 to 5 V DC)		4						
	Voltage input (0 to 10 V DC)		5						
	Voltage input (1 to 5 V DC)		6						
	Current input (0 to 20 mA DC)		7						
	Current input (4 to 20 mA DC)		8						
Event function 1 (EV1)	None			N					
	Refer to Event Type Code Table		□						
Event function 2 (EV2)	None				N				
	Refer to Event Type Code Table			□					
Event function 3 (EV3)	None					N			
	Refer to Event Type Code Table					□			
Event function 4 (EV4)	None						N		
	Refer to Event Type Code Table						□		
	Control loop break alarm (LBA)							5	
CT type <sup>1</sup>	CT1 (none), CT2 (none)								N
	CT1 (CTL-6-P-N), CT2 (none)								P
	CT1 (CTL-12-S56-10L-N), CT2 (none)								S
	CT1 (CTL-6-P-N), CT2 (CTL-6-P-N)								T
	CT1 (CTL-12-S56-10L-N), CT2 (CTL-12-S56-10L-N)								U
Communication 1 protocol	None								N
	RKC communication (ANSI X3.28-1976)								1
	Modbus								2
	Intercontroller communication <sup>2</sup>								A

<sup>1</sup> If the CT type is not specified, the instrument is shipped with the CT input setting of "CTL-6-P-N."

<sup>2</sup> Selectable in the case of optional function codes E, F, H, and J.

● Output Assignment Code Table

Code	Output 1 (OUT1)	Output 2 (OUT2)	Digital output 1 (DO1)	Digital output 2 (DO2)
01	Control output 1	Control output 2	Event output 1 (EV1)	Event output 2 (EV2)
02	Control output 1	Control output 2	Event output 1 (EV1)	Event output 4 (EV4)
03	Control output 1	Control output 2	Event output 1 (EV1)	Heater break alarm (HBA) output
04	Control output 1	Control output 2	Event output 1 (EV1)	FAIL output (De-energized)
05	Control output 1	Control output 2	Event output 4 (EV4)	Heater break alarm (HBA) output
06	Control output 1	Control output 2	Event output 4 (EV4)	FAIL output (De-energized)
07	Control output 1	Control output 2	Heater break alarm (HBA) output	FAIL output (De-energized)
08	Control output 1	Heater break alarm (HBA) output	Event output 1 (EV1)	Event output 2 (EV2)
09	Control output 1	Heater break alarm (HBA) output	Event output 1 (EV1)	Event output 4 (EV4)
10	Control output 1	Heater break alarm (HBA) output	Event output 1 (EV1)	FAIL output (De-energized)
11	Control output 1	Heater break alarm (HBA) output	Event output 4 (EV4)	FAIL output (De-energized)
12	Control output 1	FAIL output (De-energized)	Event output 1 (EV1)	Event output 2 (EV2)
13	Control output 1	FAIL output (De-energized)	Event output 1 (EV1)	Event output 4 (EV4)
14	Control output 1	Event output 1 (EV1)	Event output 2 (EV2)	Event output 3 (EV3)
15	Control output 1	Event output 4 (EV4)	Event output 1 (EV1)	Event output 2 (EV2)

- Energized/De-energized is configurable except for the FAIL output. (Factory shipment: Energized)
- When Current transformer (CT) input is two-point input, Heater break alarm (HBA) output is OR output.
- Invalid for a non-existing output/event function.
- When used as Heat/Cool PID control, select any code of 1 to 7.
- For Position proportioning PID control, output 1 (OUT1) is open-side output and output 2 (OUT2) is close-side output, regardless of the above selection.

## ● Digital Input Assignment Code Table

Code	Digital input 1 (DI1)	Digital input 2 (DI2)	Digital input 3 (DI3)	Digital input 4 (DI4)	Digital input 5 (DI5)	Selectable Optional function
01	Unused	Unused	Unused	Unused	Unused	—
02	Memory area number selection (1 to 8)			Memory area set	RUN/STOP transfer	A
03	Memory area number selection (1 to 8)			Memory area set	Unused	
04	Memory area number selection (1 to 8)			Memory area set	Auto/Manual transfer	
05	Memory area number selection (1 to 8)			Memory area set	Interlock release	
06	Memory area number selection (1 to 8)			RUN/STOP transfer	Unused	
07	Memory area number selection (1 to 8)			RUN/STOP transfer	Auto/Manual transfer	
08	Memory area number selection (1 to 8)			RUN/STOP transfer	Interlock release	
09	Memory area number selection (1 to 8)			Unused	Auto/Manual transfer	
10	Memory area number selection (1 to 8)			Unused	Interlock release	
11	Memory area number selection (1 to 8)			Auto/Manual transfer	Interlock release	
12	Memory area number selection (1 to 8)					
13	RUN/STOP transfer	Remote/Local transfer *	Auto/Manual transfer			A, E
14	RUN/STOP transfer	Remote/Local transfer *	Interlock release			
15	RUN/STOP transfer	Auto/Manual transfer	Interlock release			
16	Remote/Local transfer *	Auto/Manual transfer	Interlock release			
17	RUN/STOP transfer	Remote/Local transfer *				A, B, C, D, E
18	RUN/STOP transfer	Auto/Manual transfer				
19	RUN/STOP transfer	Interlock release				
20	Remote/Local transfer *	Auto/Manual transfer				
21	Remote/Local transfer *	Interlock release				
22	Auto/Manual transfer	Interlock release				
23	RUN/STOP transfer					A, B, C, D, E, F, J, 3, 4, 5, 6, 7, 8
24	Remote/Local transfer *					
25	Auto/Manual transfer					
26	Interlock release					

Memory area set: Switches to the memory area specified in DI1 – DI3 when the contact goes from open to closed.

\* When the optional function code A, C or D is selected, the Remote/Local transfer is invalid.

## ● Event Type Code Table

Code	Type	Code	Type	Code	Type
A	Deviation high	H	Process high	V	SV high
B	Deviation low	J	Process low	W	SV low
C	Deviation high/low	K	Process high with hold action	1	MV1 high [heat-side]
D	Band	L	Process low with hold action	2	MV1 low [heat-side]
E	Deviation high with hold action	Q	Deviation high with re-hold action	3	MV2 high [cool-side]
F	Deviation low with hold action	R	Deviation low with re-hold action	4	MV2 low [cool-side]
G	Deviation high/low with hold action	T	Deviation high/low with re-hold action		

# 1.4 Parts Description

This section describes various display units and the key functions.

## ■ Front Panel View

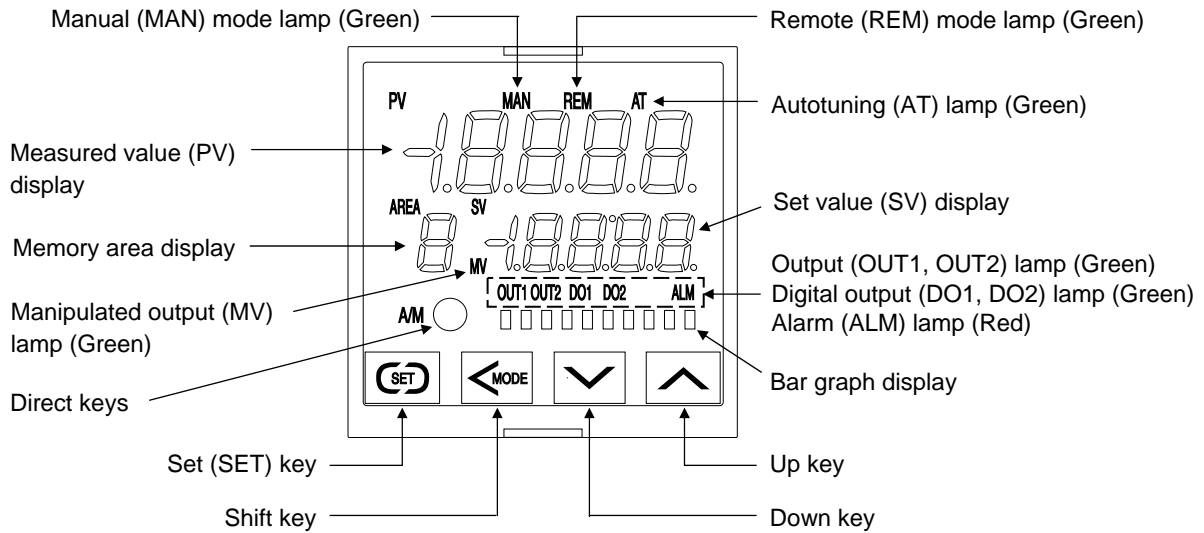

### ● Display units



Measured value (PV) display	[Green]	Displays Measured value (PV) or various parameters' symbols.
Set value (SV) display	[Orange]	Displays Set value (SV), Manipulated output value (MV) or various parameters' set values.
Memory area display	[Orange]	Displays memory area number (1 to 8).

### ● Indication lamps

Manual (MAN) mode lamp	[Green]	Lights when operated in manual mode.
Remote (REM) mode lamp	[Green]	Lights when operated in remote mode.
Autotuning (AT) lamp	[Green]	Flashes when Autotuning is activated. (After autotuning is completed: AT lamp will go out)
Manipulated output (MV) lamp	[Green]	Lights when operated in Manual mode. In this case, the Set value (SV) display shows the Manipulated output value (MV).
Output (OUT1, OUT2) lamp	[Green]	Lights when the output corresponding to each lamp is ON. ● Lamp indication becomes as follows for current output or voltage output: For an output of less than 0 %: Extinguished For an output of more than 0 % but less than 100 %: Dimly lit For an output of more than 100 %: Lit
Digital output (DO1, DO2) lamp	[Green]	Lights when the output corresponding to each lamp is ON.
Alarm (ALM) lamp	[Red]	Lights when alarm (Event or Heater break alarm [HBA]) is turned ON. The type of alarm which is on can be checked on the event monitor screen.

 These lamps work with event outputs (event function, HBA function, LBA function) which are assigned to OUT, DO and ALM.

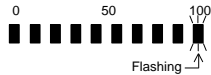
### ● Bar graph display [Green]

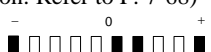
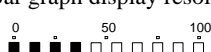
Manipulated output values (MV1, MV2) [Factory set value]	Displays the Manipulated output value (MV) [In the case of Position proportioning PID control, refer to below.]. When Manipulated output value (MV) is at 0 % or less, the left-end dot of the bar-graph flashes. When MV exceeds 100 %, the right-end dot flashes.  [Example] 
	<ul style="list-style-type: none"> <li>● Heat/Cool PID control: When both OUT1 and OUT2 light, this means overlapping, but in this case the bar graph displays only the Manipulated output value (MV1) [heat-side].</li> </ul>
	<ul style="list-style-type: none"> <li>● Position proportioning PID control: [With FBR input] Displays the FBR input value (0.0 to 100.0 %). [Without FBR input] Cannot be used as a bar graph. The bar graph displays the over-scaled state (an output of more than 100 %). In this case, it is recommended to be set to “No display.”  [Example] </li> </ul>
Measured value (PV)	Displays the Measured value (PV). Scaling is available within the input range (Input scale low to Input scale high).  [Example] 
Set value (SV) monitor	Displays the Set value (SV). Scaling is available within the input range (Input scale low to Input scale high). Remote mode: Displays the remote setting value.  [Example] 
Deviation value	Displays the deviation between the Measured value (PV) and the Set value (SV). When the Deviation display is selected, the dots at both ends of bar-graph light. A display resolution per dot is settable. (Bar graph display resolution: Refer to P. 7-68)  [Example] 
Current transformer 1 (CT1) input value Current transformer 2 (CT2) input value	Displays the input value (current value) of CT1 or CT2. (Unit: A) A display resolution per dot is settable. (Bar graph display resolution: Refer to P. 7-68)  [Example] 



The factory set value of the bar graph is “Manipulated output value.” Bar graph display type can be changed by the bar graph in the Engineering mode. (Refer to P. 7-66)

### ● Direct keys

Pressing a direct key causes one of the operation changes below.

Auto/Manual transfer [Factory set value]	Switching the Auto/Manual control mode between Auto mode and Manual mode.
Monitor	Use to switch the monitor screen. Pressing the direct key while any screen other than the SV setting & monitor mode screen is being displayed returns to the Measured value (PV)/Set value (SV) monitor screen.
Memory area transfer	Pressing the direct key changes to Memory area transfer screen.
Remote/Local transfer	Switching the Remote/Local control mode between Remote mode and Local mode.
RUN/STOP transfer	Switching the RUN/STOP mode between RUN and STOP status.



**To avoid damage to the instrument, never use a sharp object to press keys.**



The factory default setting is Auto/Manual transfer. The Direct key type can be set in “Direct key type” (P. 7-70) of Engineering mode.



When the Direct key type is “Monitor”, the display of SV setting & monitor mode and the Direct key display are different from the other types. (Refer to P. 5-4)







Use/Unused of Direct key functions is programmable. (Refer to P. 7-70)



To prevent operator error, a Direct key cannot be operated in positioning adjustment (automatic adjustment).

● **Operation keys**

	Set (SET) key	Used for parameter calling up and set value registration.
	Shift key	Shift digits when settings are changed. Used to selection operation between modes.
	Down key	Decrease numerals. Keeping pressing the DOWN key makes numeric value change faster. (Manual mode)
	Up key	Increase numerals. Keeping pressing the UP key makes numeric value change faster. (Manual mode)



To avoid damage to the instrument, never use a sharp object to press keys.

■ **Bottom View**

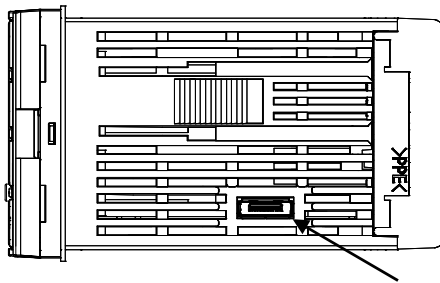

Loader communication connector (Standard equipment)



Use our communication converter COM-K (sold separately) to connect FB100 and personal computer. Then, the cable (cable length: 1.5 meters) for connection between FB100 and our communication converter COM-K is optional.

■ **Side view**

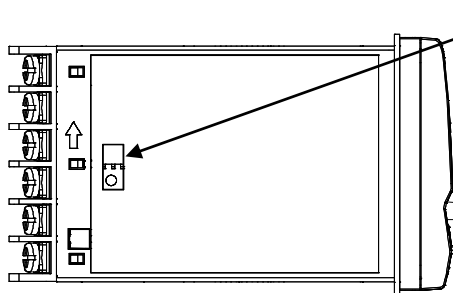

Input select switch

Dip switch is used for the switching of the measured input type and the remote setting input type.

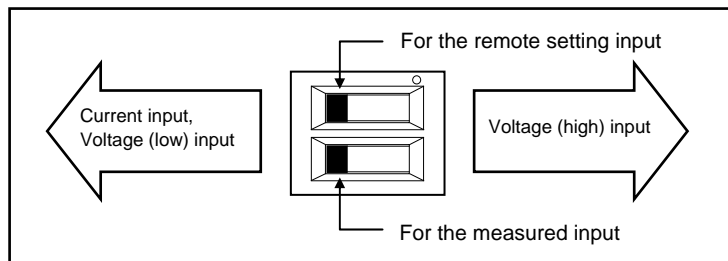

To change the input type, refer to **Input type (P. 7-71)**, **Remote setting input type (P. 7-79)** in the Engineering mode.

# 1.5 Input/Output Functions

This section describes the Input/Output functions of the instrument. To learn how to set each function, refer to the respective page.

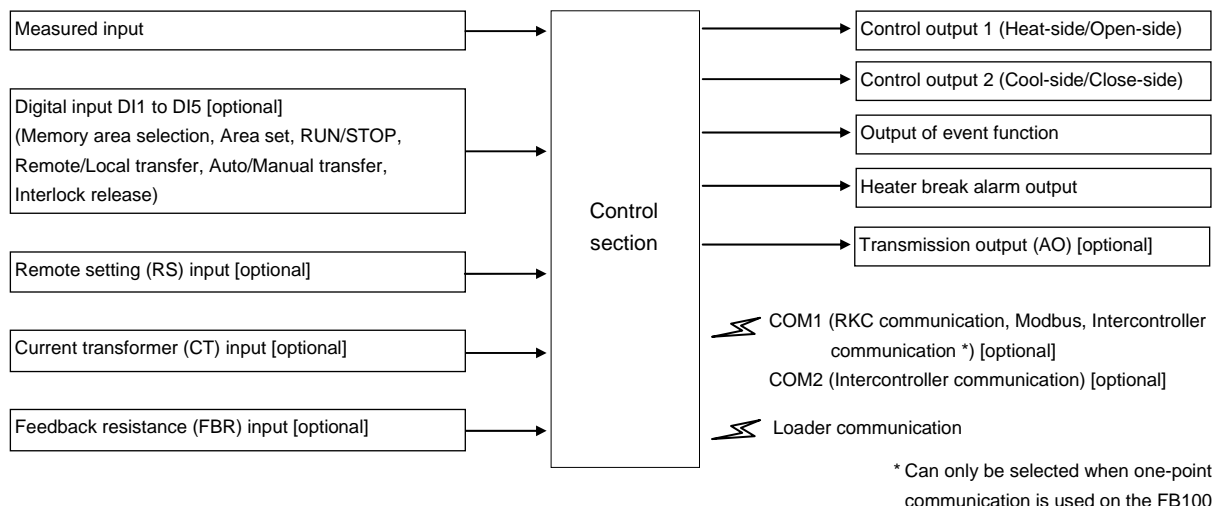

- Input** On the FB100, Measured input, Digital input (DI), Remote setting (RS) input, Current transformer (CT) input, and Feedback resistance (FBR) input can be used.

Measured input [universal input]:

- Input groups available for measured inputs are shown in the table below. (P. 7-71)

Voltage (low) input group	Thermocouple	K, J, E, T, S, R, B, N, PLII, W5Re/W26Re, U, L
	RTD	Pt100, JPt100
	Voltage (low)	0 to 1 V DC, 0 to 100 mV DC, 0 to 10 mV DC, -100 to +100 mV DC, -10 to +10 mV DC
	Current	0 to 20 mA DC, 4 to 20 mA DC
Voltage (high) input group		-1 to +1 V DC, 0 to 5 V DC, 1 to 5 V DC, 0 to 10 V DC

[Factory set value: Thermocouple K (When quick start code "N" is specified)]

- When the input type is changed, be sure to check the details of setting of the input group transfer and the input type selection by the input select switch. (P. 7-71)

Digital input [DI1 to DI5] (optional)

- Digital input (contact input signal from the external devices) can be used for the following functions.

DI1 to 5	Memory area selection (number of area: 1 to 8) + Area set, RUN/STOP, Remote/Local transfer, Auto/Manual transfer, Interlock release
----------	---

- For function assignment to the digital input, set the **Digital input (DI) assignment (P. 7-80)** in the Engineering mode.

Remote setting (RS) input [universal input] (optional)

- Remote input is to change a control set point by using current or voltage input from an external device.
- Measured input is not isolated from Remote setting (RS) input.
- Input groups available for Remote setting (RS) inputs are shown in the table below. (P. 7-79)

Voltage (low) input and Current input group	0 to 100 mV DC, 0 to 10 mV DC, 0 to 1 V DC
	0 to 20 mA DC, 4 to 20 mA DC
Voltage (low) input group	0 to 5 V DC, 1 to 5 V DC, 0 to 10 V DC

[Factory set value: Depend on model code]

- When using the Intercontroller communication (only slave controller of cascade control and ratio setting), the Remote setting (RS) input function becomes invalid.

Current transformer (CT) input (optional)

- CT input is used for Heater break alarm function to detect a heater break or short-circuit.
- Up to two CT inputs can be selected. (Specify when ordering)
- Two types of CT available.

CTL-6-P-N (for 0 to 30 A)
CTL-12-S56-10L-N (for 0 to 100 A)

- Measured input is not isolated from CT input.
- If there is CT input, power frequency is automatically set by the power frequency detection function. However, no frequency may be able to be detected if at a CT value of less than 0.5 A.

Feedback resistance (FBR) input (optional)

- When the control type is the Position proportioning PID control (with FBR input), a valve position from the control motor can be inputted to feedback resistance.
- Measured input is not isolated from Feedback resistance (FBR) input.
- Feedback resistance (FBR) input cannot be used with Current transformer (CT) input, Remote setting (RS) input and communication.



- Output** Up to five outputs are available. They may be used as Control output (OUT), Digital output (DO) or Transmission output (AO) by specifying the output type or by activating the output assignment function.

#### Output 1 (OUT1), Output 2 (OUT2)

- The following output functions can be assigned to OUT1 and/or OUT2 at the output assignment of the Engineering mode (P. 7-82):
  - Control output,
  - Heater break alarm output, or
  - FAIL (De-energized fixed: contact opens under FAIL)
- For Heat/Cool PID control, OUT1 corresponds to the heat-side output and OUT2 corresponds to the cool-side output.
- For Position proportioning PID control, OUT1 corresponds to the open-side output and OUT2 corresponds to the close-side output.
- Output types available for OUT1 and OUT2 are shown in the table below. (Specify when ordering)

Relay contact output	250 V AC 3 A (Resistive load), 30 V DC 1 A (Resistive load), 1a contact
Voltage pulse output	0/12 V DC (Allowable load resistance: 600 Ω or more)
Voltage output	0 to 5 V DC, 1 to 5 V DC, 0 to 10 V DC (Allowable load resistance: 1 kΩ or more)
Current output	0 to 20 mA DC, 4 to 20 mA DC (Allowable load resistance: 600 Ω or less)
Triac output	0.5 A (Allowable load current)
Open collector output	30 V DC or less, 100 mA (Allowable load current), Sink type

- There is not isolation between OUT1 and OUT2.
- When OUT1 and OUT2 can be used for relay contact output or triac output, there is isolation between each output (OUT1, OUT2, AO).

#### Digital output 1, 2 (DO1, DO2)

- The following output functions can be assigned to DO1 through DO4 at the output assignment of the Engineering mode (P. 7-82):
  - Output of event function,
  - Heater break alarm output, or
  - FAIL (De-energized fixed: contact opens under FAIL)
- The output type for DO1 and DO2 is relay only. (Specify when ordering)

Relay contact output	250 V AC 1 A (Resistive load), 30 V DC 1 A (Resistive load), 1a contact
----------------------	---

#### Transmission output (AO) [optional]

- Output types available for transmission output are shown in the table below. (Specify when ordering)

Voltage output	0 to 1 V DC, 0 to 5 V DC, 1 to 5 V DC, 0 to 10 V DC (Allowable load resistance: 1 kΩ or more)
Current output	0 to 20 mA DC, 4 to 20 mA DC (Allowable load resistance: 600 Ω or less)

- Parameter values shown in the following table can be output by Transmission output (P. 7-86). These transmission output data can be output after being scaled.

Measured value (PV)	Set value (SV) monitor	Deviation value
Manipulated output value (MV1) [heat-side]	Manipulated output value (MV2) [cool-side]	Set value (SV)
Remote setting (RS) input value		

- Number of output: 1 point

## ■ Communication

### Communication 1 (optional)

- In this case of one-point communication, Host communication or Intercontroller communication can be selected. (This can be specified when the order is placed.)
- In this case of two-point communication, this will be for Host communication.
- Communication protocol is used for RKC communication (ANSI X3.28-1976) or Modbus. (Specify when ordering)
- With Intercontroller communication, data can be exchanged between multiple FB100/400/900 instruments without using analog signals such as Remote setting input or Transmission output, or communication with a host computer. (Refer to P. 6-61)
- Communication Interface: RS-485 only
- The following four functions become usable when the Intercontroller communication is used.
  - Automatic temperature rise function (with learning function)
  - Cascade control function
  - Ratio setting function
  - Group RUN/STOP function

☞ For details of the Host communication, refer to the separate **FB100/FB400/FB900 Communication Instruction Manual (IMR01W04-E□)**.

### Communication 2 (optional)

- This can be used only for two-point communication.
- Communication 2 (COM2) is used for the Intercontroller communication. Data can be exchanged between two or more FB100s/400s/900s without using communication with analog signals such as Remote setting input and Analog output as well as with the host computer. (Refer to P. 6-61.)
- Interface: RS-485 only
- The following four functions become usable when the Intercontroller communication is used.
  - Automatic temperature rise function (with learning function)
  - Cascade control function
  - Ratio setting function
  - Group RUN/STOP function

#### [Connection example]

- When one-point communication is used

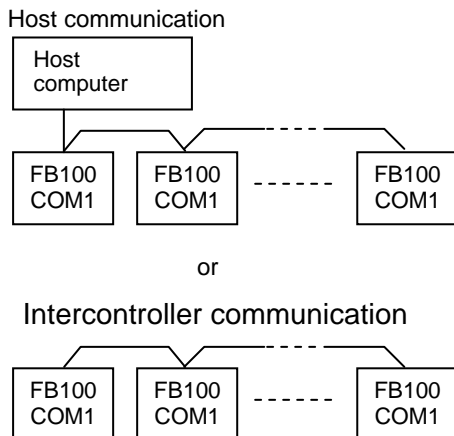

- When two-point communication is used

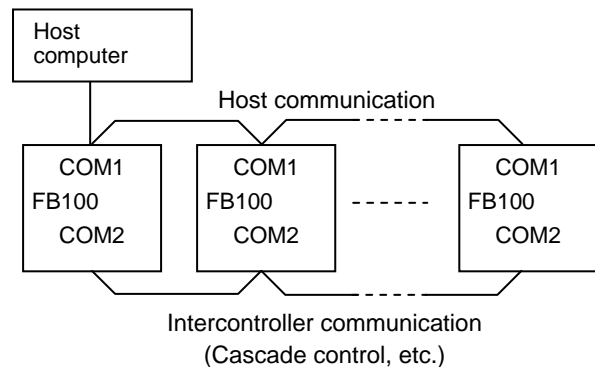

## Loader communication

- It is possible to manage data on the personal computer side by converting all of the data in the FB100 into one file.<sup>1</sup>
- When starting the Loader communication, first your PC (Windows 2000/XP/Vista/7) being used is necessary to be installed with the communication tool<sup>2</sup>.

<sup>1</sup> Use our communication converter COM-K (sold separately) to connect FB100 and your PC.

<sup>2</sup> The communication tool (WinUCI, PROTEM2) can be downloaded from the RKC official website: <http://www.rkcinst.com/>.



**The Loader port is only for parameter setup.**



The Loader communication corresponds to the RKC communication protocol “Based on ANSI X3.28-1976 subcategories 2.5 and A4.”



For the COM-K, refer to the **COM-K Instruction Manual (IMR01Z01-E□)**.

### [Connection example]

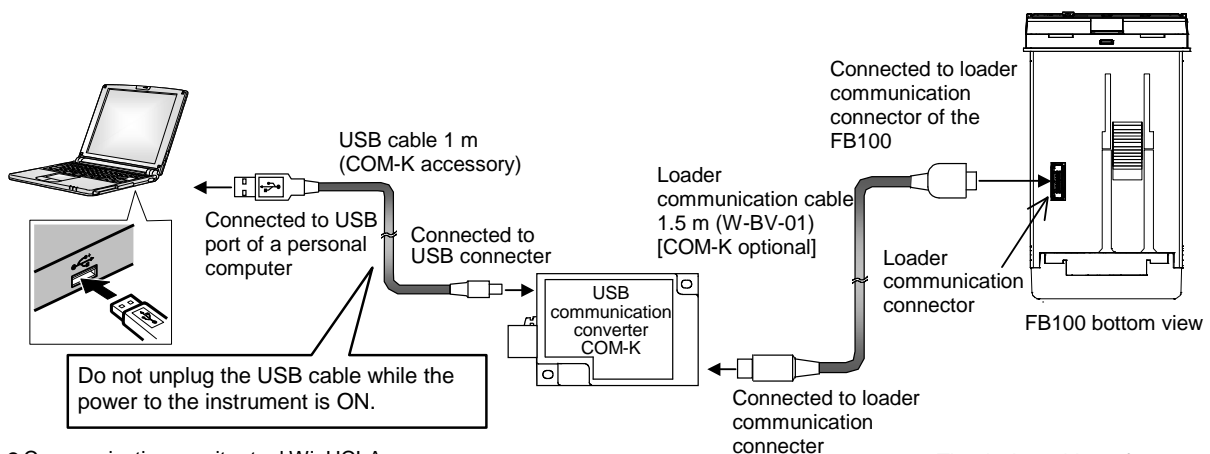

- Communication monitor tool WinUCI-A  
Software operation environment: Windows 2000 or higher
- Communication setup tool WinUCI-B for FB series  
Software operation environment: Windows 2000 or higher
- Communication tool PROTEM2  
Software operation environment: Windows XP (Service Pack 2) or higher  
PROTEM2 needs Microsoft .NET Framework 4.0 or later
- Communication port of host computer  
USB port: Based on USB Ver. 2.0
- Communication settings on the computer  
(Values other than the communication port are fixed.)  
Communication speed: 38400 bps  
Start bit: 1  
Data bit: 8  
Parity bit: Without  
Stop bit: 1

The device address for Loader communication is fixed at “0.”  
The setting of the device address is disregarded.

# **MEMO**

# **HANDLING PROCEDURE TO OPERATION**



This chapter describes procedures to set operating conditions of a customer and parameter of various setting modes.

■ **Setting procedure to operation**

Conduct necessary setting before operation according to the procedure described below.

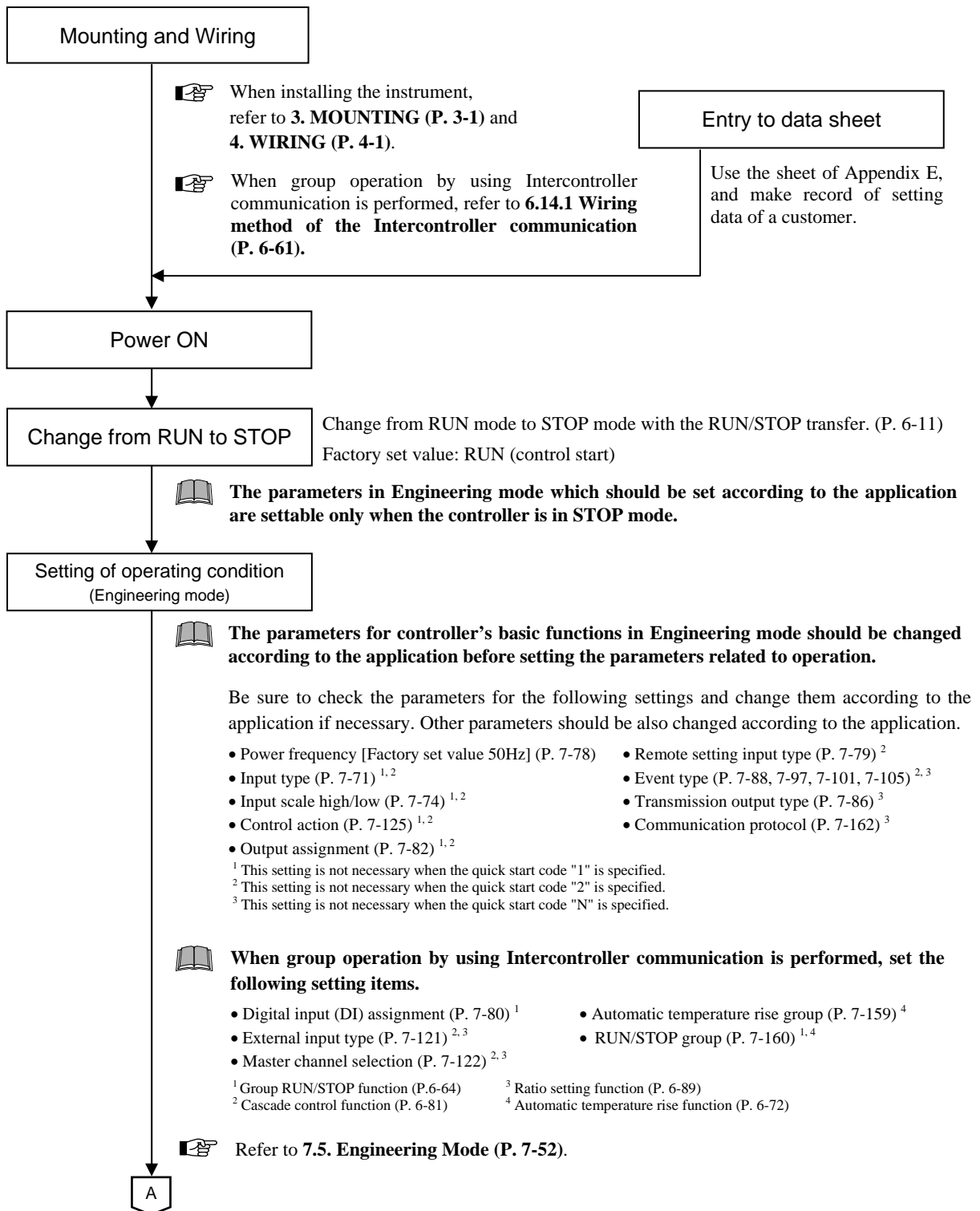

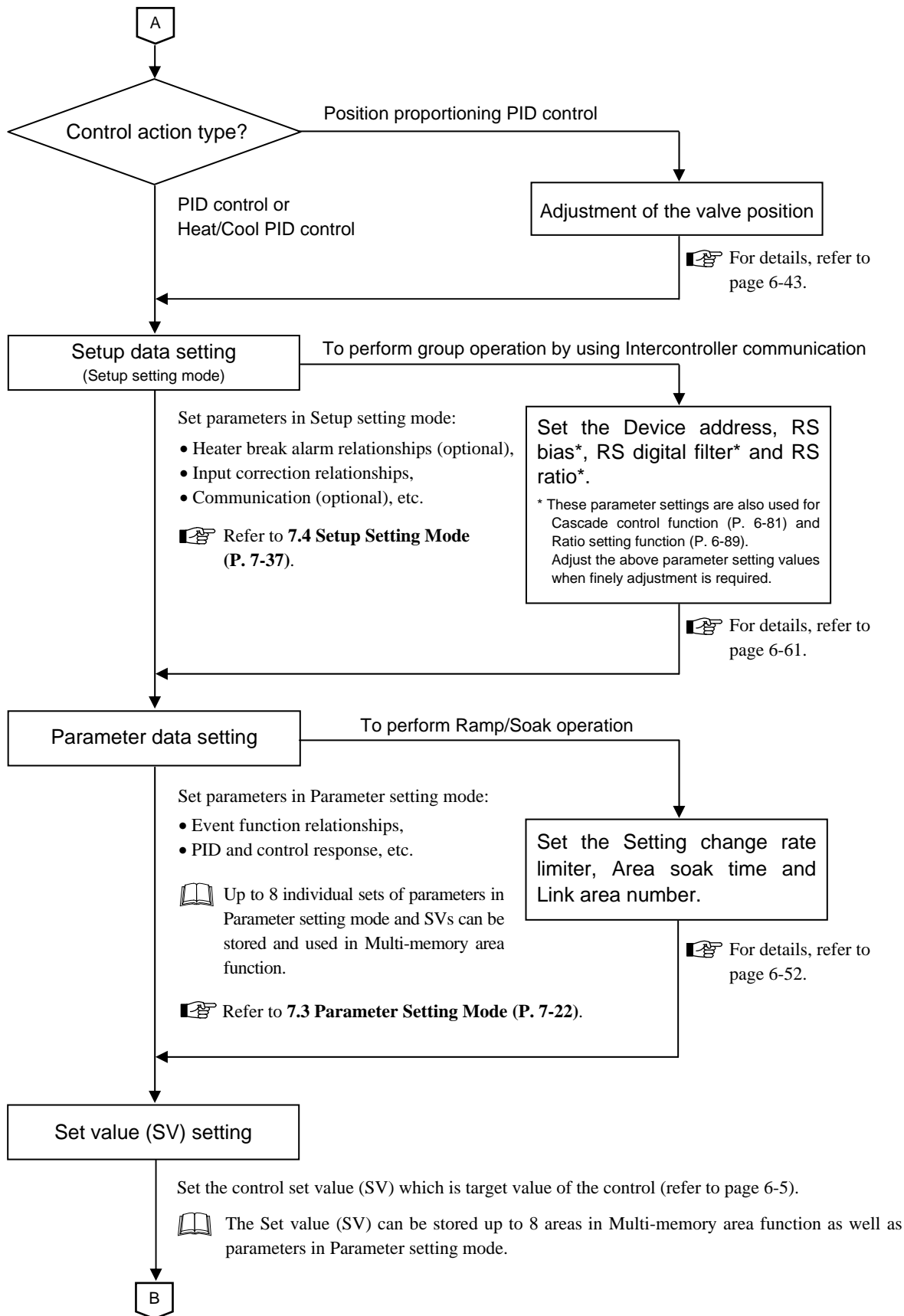

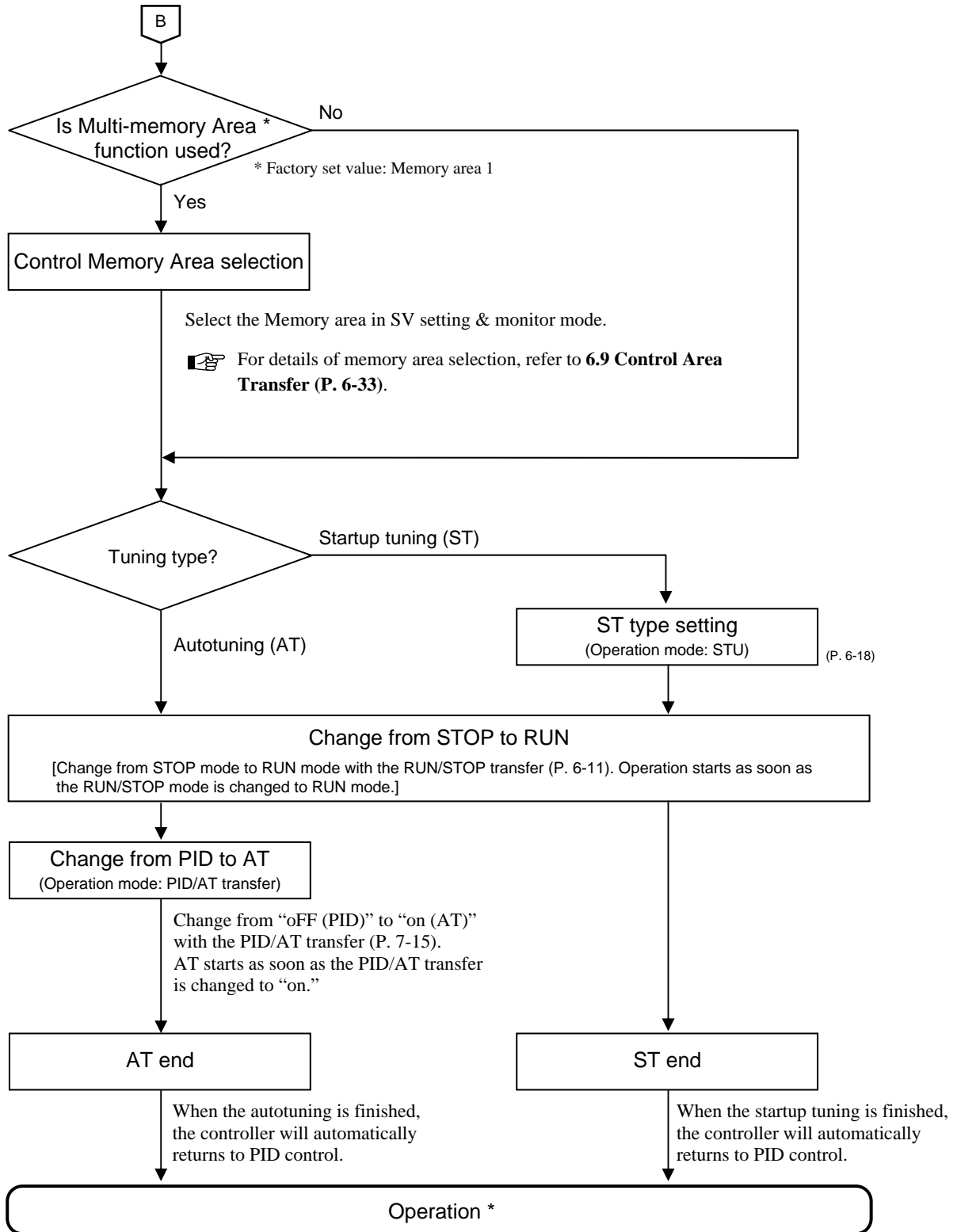

\* Adjust the PID constants manually when the optimum PID constants cannot be computed by Autotuning for characteristic variations of the controlled system (refer to page 6-9).



# MOUNTING



- 3.1 Mounting Cautions.....3-2
- 3.2 Dimensions .....3-3
- 3.3 Procedures of Mounting and Removing.....3-4

## 3.1 Mounting Cautions

This chapter describes installation environment, mounting cautions, dimensions and mounting procedures.



### WARNING

To prevent electric shock or instrument failure, always turn off the power before mounting or removing the instrument.

- (1) This instrument is intended to be used under the following environmental conditions. **(IEC61010-1)**  
[OVERVOLTAGE CATEGORY II, POLLUTION DEGREE 2]
- (2) Use this instrument within the following environment conditions:
  - Allowable ambient temperature:  $-10$  to  $+50$  °C
  - Allowable ambient humidity: 5 to 95 %RH  
(Absolute humidity: MAX. W. C  $29.3$  g/m<sup>3</sup> dry air at 101.3 kPa)
  - Installation environment conditions: Indoor use  
Altitude up to 2000 m
- (3) Avoid the following conditions when selecting the mounting location:
  - Rapid changes in ambient temperature which may cause condensation.
  - Corrosive or inflammable gases.
  - Direct vibration or shock to the mainframe.
  - Water, oil, chemicals, vapor or steam splashes.
  - Excessive dust, salt or iron particles.
  - Excessive induction noise, static electricity, magnetic fields or noise.
  - Direct air flow from an air conditioner.
  - Exposure to direct sunlight.
  - Excessive heat accumulation.
- (4) Mount this instrument in the panel considering the following conditions:
  - Provide adequate ventilation space so that heat does not build up.
  - Do not mount this instrument directly above equipment that generates large amount of heat (heaters, transformers, semi-conductor functional devices, large-wattage resistors.)
  - If the ambient temperature rises above  $50$  °C, cool this instrument with a forced air fan, cooler, etc. Cooled air should not blow directly on this instrument.
  - In order to improve safety and the immunity to withstand noise, mount this instrument as far away as possible from high voltage equipment, power lines, and rotating machinery.
    - High voltage equipment: Do not mount within the same panel.
    - Power lines: Separate at least 200 mm.
    - Rotating machinery: Separate as far as possible.
  - Mount this instrument in the horizontal direction for panel. If you did installation except a horizontal direction, this causes malfunction.
- (5) If this instrument is permanently connected to equipment, it is important to include a switch or circuit-breaker into the installation. This should be in close proximity to the equipment and within easy reach of the operator. It should be marked as the disconnecting device for the equipment.

## 3.2 Dimensions

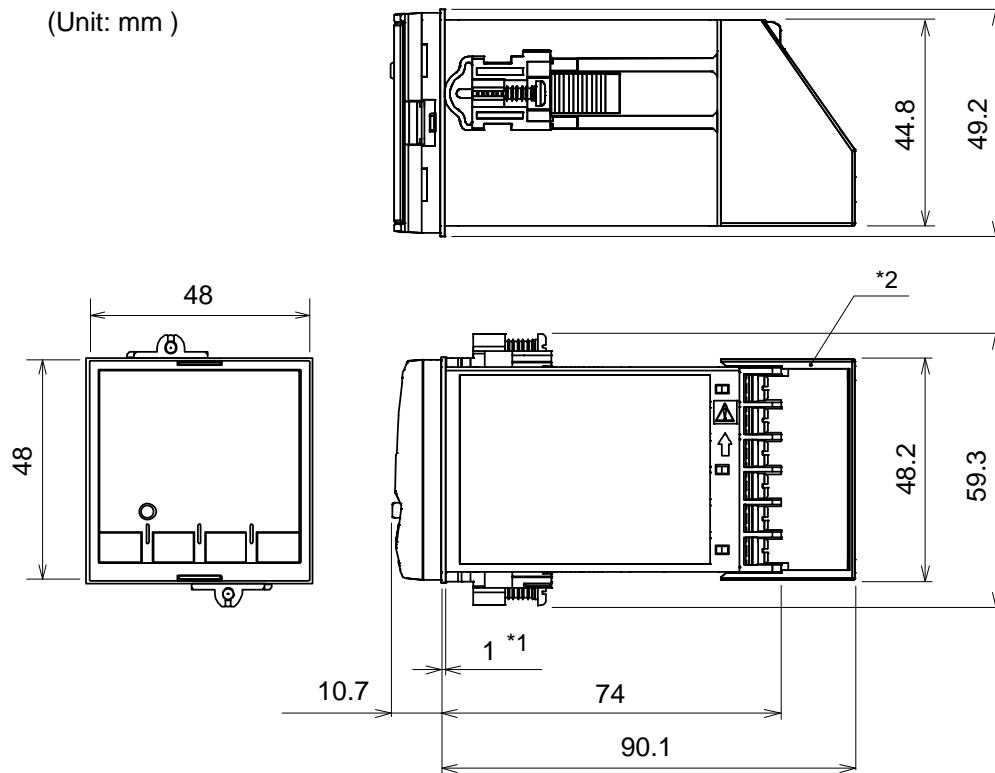

Panel thickness: 1 to 10 mm

(When mounting multiple FB100s close together, the panel strength should be checked to ensure proper support.)

Individual mounting <sup>\*3</sup>

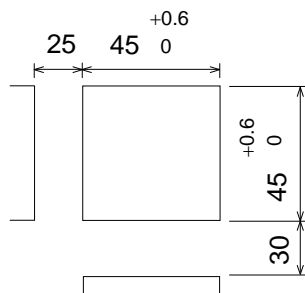

Close mounting <sup>\*4, \*5</sup>

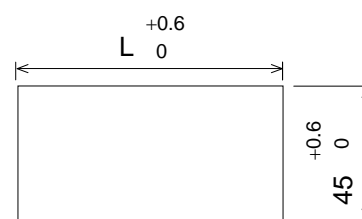

$$L = 48 \times n - 3$$

n: Number of controllers (2 to 6)

\*1 Case rubber packing

\*2 Terminal cover KCA100-517 (optional) [sold separately]

\*3 When cutting out each mounting hole through a panel for individual mounting, observe that there is no burr or distortion along the panel cutout surface, or there is no bend on the panel surface. If so, the water resistant characteristics may worsen.

\*4 Remove the case rubber packing. When the FB series is mounted closely protection will be compromised and they will not meet **IP66 (NEMA 4X)** standards.

\*5 When controllers are closely mounted, ambient temperature must not exceed 50 °C.

## 3.3 Procedures of Mounting and Removing

### ■ Mounting procedures

1. Prepare the panel cutout as specified in **3.2 Dimensions**.  
(Panel thickness: 1 to 10 mm)
2. Insert the instrument through the panel cutout.
3. Insert the mounting bracket into the mounting groove of the instrument. (Fig. 3.1)
4. Push the mounting bracket forward until the bracket is firmly secured to the panel. (Fig. 3.2)
5. Only turn one full revolution after the screw touches the panel. (Fig. 3.3)
6. The other mounting bracket should be installed the same way described in 3. to 5.

 The front of the instrument conforms to **IP66 (NEMA4X)** when mounted on the panel.  
For effective Waterproof/Dustproof, the gasket must be securely placed between instrument and panel without any gap. If gasket is damaged, please contact RKC sales office or the agent.

 For replacing of rubber packing, refer to **APPENDIX B. Replacing the Waterproof/ Dustproof Rubber Packing (P. A-4)**.

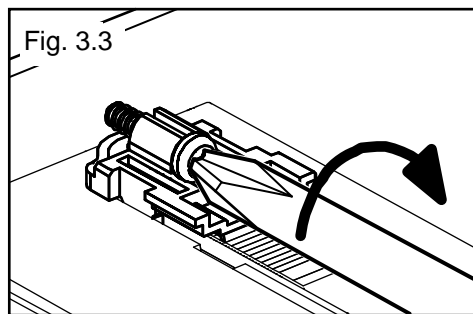
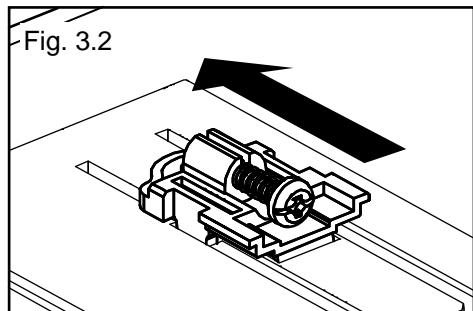
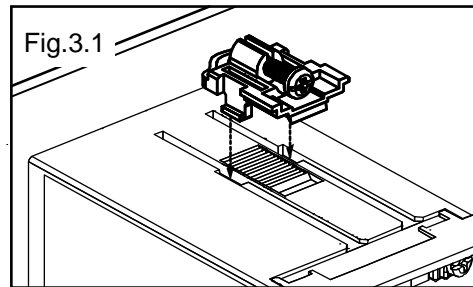

### ■ Removing procedures

1. Turn the power OFF.
2. Remove the wiring.
3. Loosen the screw of the mounting bracket. (Fig. 3.4)
4. Lift the latch of the mounting bracket (①), then pull the mounting bracket (②) to remove it from the case. (Fig. 3.4)
5. The other mounting bracket should be removed in the same way as described in 3. and 4.
6. Pull out the instrument from the mounting cutout while holding the front panel frame of this instrument. (Fig. 3.5)

 Use long-nose pliers to remove mounting brackets from the instrument that is installed in a narrow place or installed tightly in a vertical position.

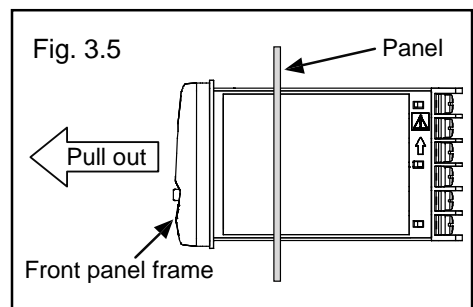
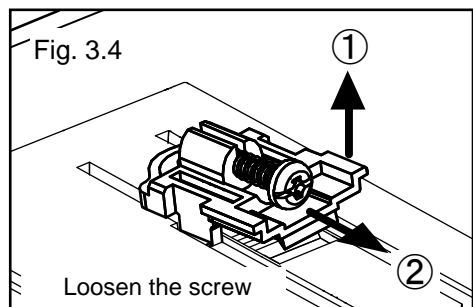
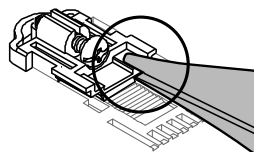

# WIRING



4.1 Wiring Cautions .....	4-2
4.2 Terminal Layout .....	4-4
4.3 Wiring of Each Terminal .....	4-6
4.3.1 Power .....	4-6
4.3.2 Output 1 (OUT1)/Output 2 (OUT2).....	4-7
4.3.3 Digital output 1, 2 (DO1, DO2) .....	4-9
4.3.4 Measurement input (Thermocouple/RTD/Voltage/Current) .....	4-9
4.3.5 Optional.....	4-10

## 4.1 Wiring Cautions

This chapter describes wiring cautions, wiring layout and wiring of terminals.



### WARNING

To prevent electric shock or instrument failure, do not turn on the power until all wiring is completed. Make sure that the wiring is correct before applying power to the instrument.

- For thermocouple input, use the appropriate compensation wire.
- For RTD input, use low resistance lead wire with no difference in resistance between the three lead wires.
- To avoid noise induction, keep input signal wire away from instrument power line, load lines and power lines of other electric equipment.
- If there is electrical noise in the vicinity of the instrument that could affect operation, use a noise filter.
  - Shorten the distance between the twisted power supply wire pitches to achieve the most effective noise reduction.
  - Always install the noise filter on a grounded panel. Minimize the wiring distance between the noise filter output and the instrument power supply terminals to achieve the most effective noise reduction.
  - Do not connect fuses or switches to the noise filter output wiring as this will reduce the effectiveness of the noise filter.
- Allow approximately 5 seconds for contact output when the instrument is turned on. Use a delay relay when the output line is used for an external interlock circuit.
- Power supply wiring must be twisted and have a low voltage drop.
- For an instrument with 24 V power supply, supply power from a SELV circuit.
- A suitable power supply should be considered in end-use equipment. The power supply must be in compliance with a limited-energy circuits (maximum available current of 8 A).
- This instrument is not furnished with a power supply switch or fuse. If a fuse or power supply switch is required, install close to the instrument.

Recommended fuse rating: Rated voltage 250 V, Rated current 1 A

Fuse type: Time-lag fuse

- Use the solderless terminal appropriate to the screw size.
  - Screw size: M3 × 7 (With 5.8 × 5.8 square washer)
  - Recommended tightening torque:

0.4 N·m (4 kgf·cm)

Applicable wire: Solid/twisted wire of 0.25 to 1.65 mm<sup>2</sup>

Specified dimension: Refer to Fig. 4.1

Specified solderless terminals:

Manufactured by J.S.T MFG CO., LTD.

Circular terminal with isolation

V1.25-MS3

(M3 screw, width 5.5 mm, hole diameter 3.2 mm)

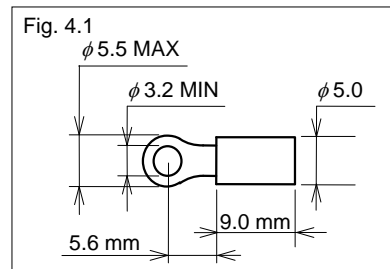

- Make sure that the any wiring such as solderless terminal is not in contact with the adjoining terminals.

- When wiring, wire from the left direction toward the backside terminals as shown in Fig. 4.2. For FB100, the wiring surfaces of the central and right side lines of terminals are inclined to make it easier to wire from the left side. When using the terminal cover (Figs. 4.2), it is not possible to wire from the right side. When wiring from the left and right with a close mounting, there are cases where adjacent instruments cannot be wired.

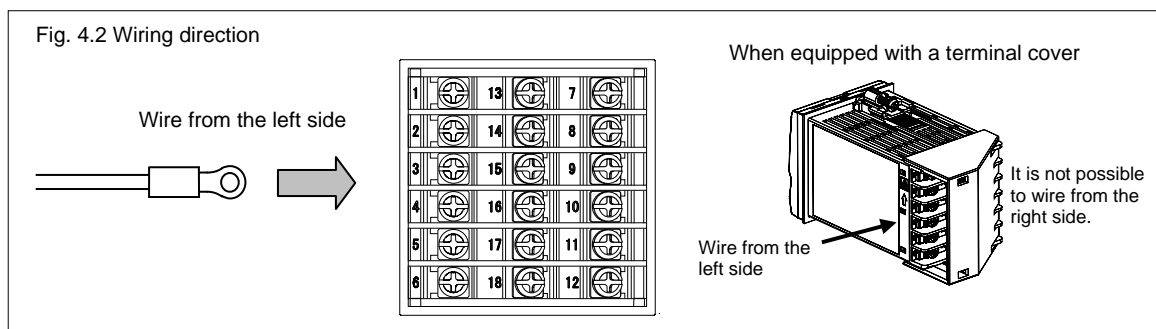

- Up to two solderless terminal lugs can be connected to one terminal screw. However, **reinforced insulation cannot be used.**

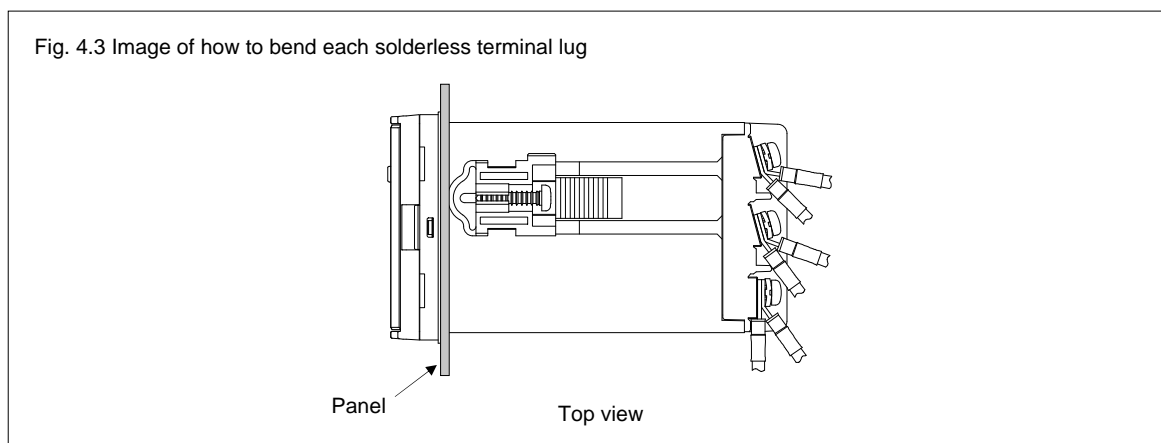

- If solderless terminal lugs other than the recommended dimensions are used, terminal screws may not tighten. In that case, bend each solderless terminal lug before wiring. If the terminal screw is forcibly tightened, it may be damaged.
- If two solderless terminal lugs are connected to one terminal screw, a terminal cover cannot be used.

- Caution for the terminal cover usage:
  - To prevent electrical shock or instrument failure, always turn off the power before mounting or removing the terminal cover.
  - When mounting and removing the terminal cover, apply pressure very carefully to avoid damage to the terminal cover.

## 4.2 Terminal Layout

The terminal layout is as follows.

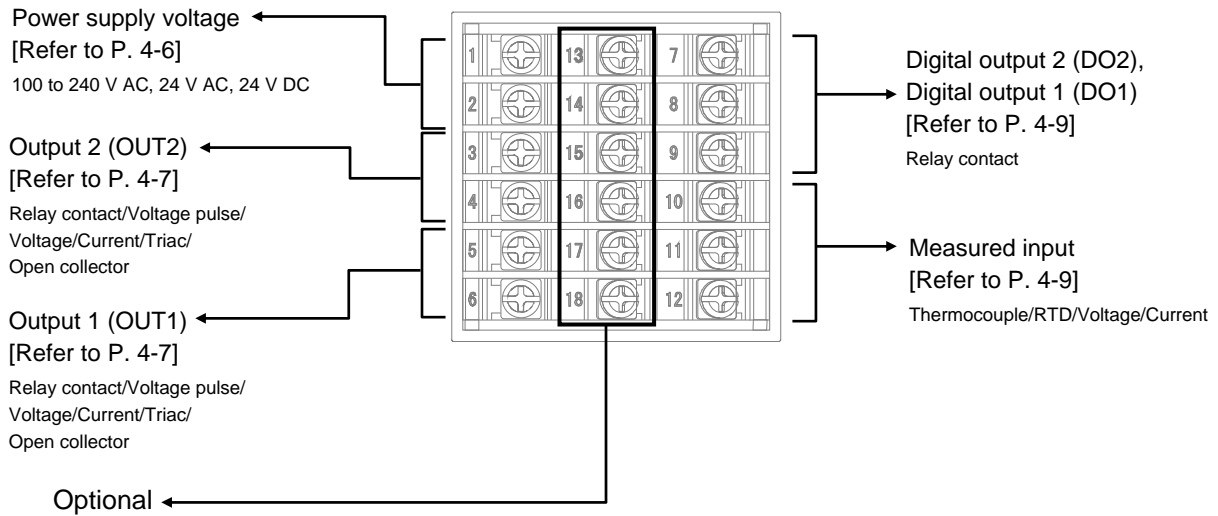

Optional function: A Digital input (DI1 to DI5)  
[Refer to P. 4-10]

Optional function: B Digital input (DI1, DI2)  
Remote setting (RS) input [Voltage/Current]  
[Refer to P. 4-11]

Optional function: C Digital input (DI1, DI2)  
Feedback resistance (FBR) input  
[Refer to P. 4-12]

Optional function: D Digital input (DI1, DI2)  
Current transformer input (CT1, CT2)  
[Refer to P. 4-13]

Optional function: E Digital input (DI1 to DI3)  
Communication 1 (RKC communication, Modbus, Intercontroller communication) [RS-485]  
[Refer to P. 4-14]

Optional function: F Digital input (DI1)  
Current transformer input (CT1)  
Communication 1 (RKC communication, Modbus, Intercontroller communication) [RS-485]  
[Refer to P. 4-15]

Optional function: G Communication 1 (RKC communication, Modbus) [RS-485]  
Communication 2 (Intercontroller communication) [RS-485]  
[Refer to P. 4-16]

Optional function: H Communication 1 (RKC communication, Modbus, Intercontroller communication) [RS-485]  
Current transformer input (CT1, CT2)  
[Refer to P. 4-17]

Optional function: J Communication 1 (RKC communication, Modbus, Intercontroller communication) [RS-485]  
Digital input (DI1)  
Remote setting (RS) input [Voltage/Current]  
[Refer to P. 4-18]

Optional function: 3, 4, 5, 6, 7, 8  
Digital input (DI1)  
Remote setting (RS) input [Voltage/Current]  
Transmission output (AO) [Voltage/Current]  
[Refer to P. 4-20]



## ■ Isolations of input and output

For isolated device input/output blocks, refer to the following:

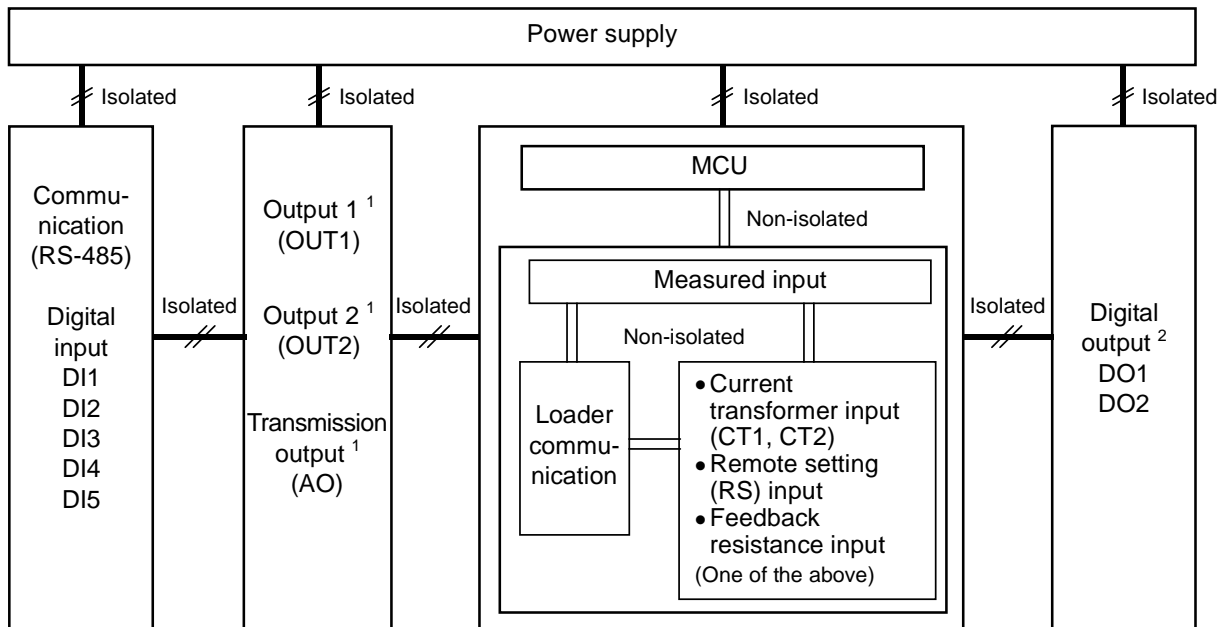

<sup>1</sup> Outputs are isolated if Output 1 (OUT1) or Output 2 (OUT2) is Relay contact output or Triac trigger output. If both outputs are Relay contact output or Triac trigger output, outputs are not isolated.

<sup>2</sup> During output of Digital output (Relay contact output only), all are in an "Isolated" relationship.

## 4.3 Wiring of Each Terminal

Prior to conducting wiring, always check the polarity of each terminal.

### 4.3.1 Power supply

- Connect the power to terminal numbers 1 and 2.

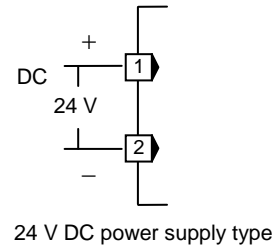
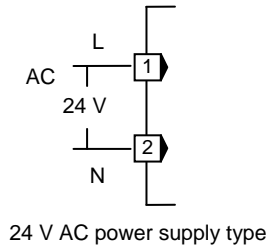
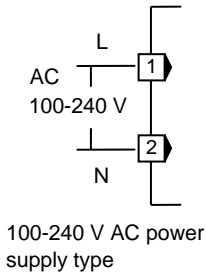

- Power supply types must be specified when ordering. Power supply voltage for the controller must be within the range shown below to accurate control accuracy.

Specification code	Power supply type	Power consumption
4	90 to 264 V AC (Power supply voltage range), [Rating 100 to 240 V AC] Power supply frequency: 50/60 Hz	5.4 VA max. (at 100 V AC), 8.1 VA max. (at 240 V AC)
3	21.6 to 26.4 V AC (Power supply voltage range), [Rating 24 V AC] Power supply frequency: 50/60 Hz	5.3 VA max. (at 24 V AC)
3	21.6 to 26.4 V DC (Power supply voltage range), [Rating 24 V DC]	142 mA max. (at 24 V DC)

- If there is electrical noise in the vicinity of the instrument that could affect operation, use a noise filter.
- Power supply wiring must be twisted and have a low voltage drop.
- This instrument is not furnished with a power supply switch or fuse. Therefore, if a fuse or power supply switch is required, install close to the instrument.  
Recommended fuse rating: Rated voltage 250 V, Rated current 1 A  
Fuse type: Time-lag fuse
- For an instrument with 24 V power supply, supply power from a SELV circuit.
- A suitable power supply should be considered in end-use equipment. The power supply must be in compliance with a limited-energy circuits (maximum available current of 8 A).

### 4.3.2 Output 1 (OUT1)/Output 2 (OUT2)

- Terminal 5 and 6 are for Output 1 (OUT1); Terminal 3 and 4 are for Output 2 (OUT2).
- Connect an appropriate load according to the output type. (Specify when ordering)

	PID control (Direct/Reverse action)	Heat/Cool PID control (or Position proportioning PID control)	Wiring example
Relay contact output			
Voltage pulse output			
Voltage output/ Current output			
Triac output			
Open collector output			

- OUT1 is not isolated from OUT2.
- When OUT1 and OUT2 can be used for Relay contact output (250 V AC 3 A, 30 V DC 1 A) or Triac output, there is isolation between each output (OUT1, OUT2, AO).
- OUT1 and OUT2 can be used for control output, Heater break alarm output, Event output or FAIL (De-energized fixed: Contact opens under FAIL). Refer to page 4-8.

Continued on the next page.

Continued from the previous page.

- Number of outputs and output types must be specified when ordering. The specifications of each output are as follows.

Specification code	Output type	Specifications
M	Relay contact output	250 V AC, 3A (Resistive load)/30 V DC, 1 A (Resistive load) 1a contact
V	Voltage pulse output	0/12 V DC (Allowable load resistance: 600 $\Omega$ or more)
4	Voltage output	0 to 5 V DC (Allowable load resistance: 1 k $\Omega$ or more)
5		0 to 10 V DC (Allowable load resistance: 1 k $\Omega$ or more)
6		1 to 5 V DC (Allowable load resistance: 1 k $\Omega$ or more)
7	Current output	0 to 20 mA DC (Allowable load resistance: 600 $\Omega$ or less)
8		4 to 20 mA DC (Allowable load resistance: 600 $\Omega$ or less)
T	Triac output	AC output (Allowable load current: 0.5 A [Ambient temperature 40 °C or less]), Load voltage: 75 to 250 V AC, Minimum load current: 30 mA, ON voltage: 1.6 V or less (at maximum load current)
D	Open collector output	Sink type (Allowable load current: 100 mA), Load voltage: 30 V DC or less, Minimum load current: 0.5 mA, ON voltage: 2 V or less (at maximum load current), Leakage current at OFF: 0.1 mA or less

- Output assignments are either specified by Quick start code 2 when the order is placed, or set in Engineering mode. Assignments are shown below.

Output Assignment Code Table

Code	Output 1 (OUT1)	Output 2 (OUT2)	Digital output 1 (DO1)	Digital output 2 (DO2)
01	Control output 1	Control output 2	Event output 1 (EV1)	Event output 2 (EV2)
02	Control output 1	Control output 2	Event output 1 (EV1)	Event output 4 (EV4)
03	Control output 1	Control output 2	Event output 1 (EV1)	Heater break alarm (HBA) output
04	Control output 1	Control output 2	Event output 1 (EV1)	FAIL output (De-energized)
05	Control output 1	Control output 2	Event output 4 (EV4)	Heater break alarm (HBA) output
06	Control output 1	Control output 2	Event output 4 (EV4)	FAIL output (De-energized)
07	Control output 1	Control output 2	Heater break alarm (HBA) output	FAIL output (De-energized)
08	Control output 1	Heater break alarm (HBA) output	Event output 1 (EV1)	Event output 2 (EV2)
09	Control output 1	Heater break alarm (HBA) output	Event output 1 (EV1)	Event output 4 (EV4)
10	Control output 1	Heater break alarm (HBA) output	Event output 1 (EV1)	FAIL output (De-energized)
11	Control output 1	Heater break alarm (HBA) output	Event output 4 (EV4)	FAIL output (De-energized)
12	Control output 1	FAIL output (De-energized)	Event output 1 (EV1)	Event output 2 (EV2)
13	Control output 1	FAIL output (De-energized)	Event output 1 (EV1)	Event output 4 (EV4)
14	Control output 1	Event output 1 (EV1)	Event output 2 (EV2)	Event output 3 (EV3)
15	Control output 1	Event output 4 (EV4)	Event output 1 (EV1)	Event output 2 (EV2)

- Energized/De-energized is configurable except for the FAIL output. (Factory shipment: Energized)
- When Current transformer (CT) input is two-point input, Heater break alarm (HBA) output is OR output.
- Invalid for a non-existing output/event function.
- When used as Heat/Cool PID control, select any code of 1 to 7.
- For Position proportioning PID control, output 1 (OUT1) is open-side output and output 2 (OUT2) is close-side output, regardless of the above selection.

### 4.3.3 Digital output 1, 2 (DO1, DO2)

- Terminals 7 through 9 for Digital output (DO1, DO2).

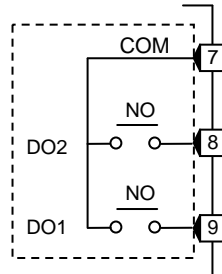

- Wiring example

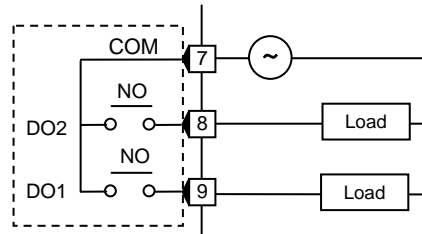

- Output type is only Relay contact output.

Relay contact output	250 V AC, 1A (Resistive load)/30 V DC, 1 A (Resistive load) 1a contact Electrical life: 300,000 times or more (Rated load)
----------------------	---

- DO1 and DO2 can be used for output of the Event function, Heater break alarm output, or FAIL (De-energized fixed: Contact opens under FAIL). Refer to page 4-8.

### 4.3.4 Measured input (Thermocouple/RTD/Voltage/Current)

- For the Measured input type, terminals 10 through 12 are allocated to the Measured input.

Thermocouple input

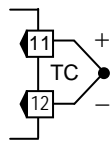

RTD input

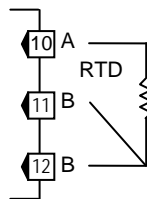

Voltage input

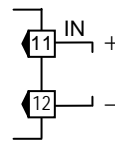

Current input

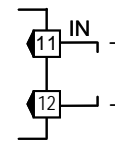

- The input types (input group) are as follows.

Input group	Input type	
Voltage (low) input group	Thermocouple	K, J, E, T, S, R, B, N, PLII, W5Re/W26Re, U, L
	RTD	Pt100, JPt100
	Voltage (low)	0 to 1 V DC, 0 to 100 mV DC, 0 to 10 mV DC, -100 to +100 mV DC, -10 to +10 mV DC
	Current	0 to 20 mA DC, 4 to 20 mA DC
Voltage (high) input group	-1 to +1 V DC, 0 to 5 V DC, 1 to 5 V DC, 0 to 10 V DC	

- For Thermocouple input, use the appropriate compensation wire.
- For RTD input, use low resistance lead wires with no difference in resistance between the three lead wires.
- To avoid noise induction, keep input signal wire away from instrument power line, load lines and power lines of other electric equipment.

### 4.3.5 Optional

- Terminals 13 through 18 for optional function.

#### ■ Optional function: A [Digital input (5 points)]

##### ● Digital input (DI1 to DI5)

- Terminals 13 through 18 for DI1 to DI5.

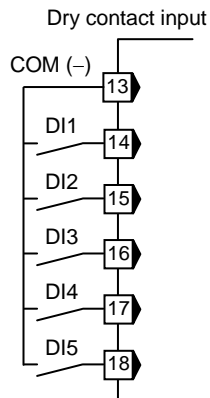

- Digital input from external devices or equipment should be dry contact input. If it is not dry contact input, the input should have meet the specifications below.

Contact specifications: At OFF (contact open) 500 k $\Omega$  or more  
At ON (contact closed) 10  $\Omega$  or less

- The following functions can be assigned to Digital inputs.

Memory area transfer (Number of area: 1 to 8) + Area set,

Memory area transfer [without area set] (Number of area: 1 to 8),

RUN/STOP transfer, Remote/Local transfer, Auto/Manual transfer, Interlock release

-  To assign functions to Digital inputs, refer to **7.5 Engineering Mode (P. 7-80)**.

## ■ Optional function: B [Digital input (2 points), Remote setting input (1 point)]

### ● Digital input (DI1, DI2)

- Terminals 13 through 15 are used for DI1 and DI2.

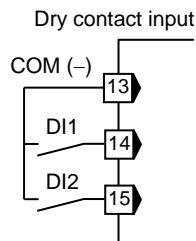

- Digital input from external devices or equipment should be dry contact input. If it is not dry contact input, the input should meet the specifications below.

Contact specifications: At OFF (contact open) 500 k $\Omega$  or more

At ON (contact closed) 10  $\Omega$  or less

- The following functions can be assigned to Digital inputs.

RUN/STOP transfer, Remote/Local transfer, Auto/Manual transfer, Interlock release

To assign functions to Digital inputs, refer to **7.5 Engineering Mode (P. 7-80)**.

### ● Remote setting (RS) input

- Remote setting (RS) input has provided as standard specifications.
- Terminal 17 and 18 are used for Remote setting (RS) input. Connect an input according to the Remote setting (RS) input type\*.

\* The following two methods of the RS input selection are available:

Specify when ordering (Initial setting code)

Setting by Remote setting (RS) input type of Engineering mode (Refer to page 7-79)

<Initial setting code (Quick start code 2)>		Any one of the following input types can be selected.	
Specification code	Input type	Specification code	Input type
1	Voltage input (0 to 10 mV DC)	5	Voltage input (0 to 10 V DC)
2	Voltage input (0 to 100 mV DC)	6	Voltage input (1 to 5 V DC)
3	Voltage input (0 to 1 V DC)	7	Voltage input (0 to 20 mA DC)
4	Voltage input (0 to 5 V DC)	8	Voltage input (4 to 20 mA DC)

- Remote setting (RS) input is not isolated from the Measured input.



In the case of optional function B, terminal 16 is not used, and is connected internally to SG (signal ground).

■ **Optional function: C [Digital input (2 points), Feedback resistance input (1 point)]**

● **Digital input (DI1, DI2)**

- Terminals 13 through 15 are used for DI1 and DI2.

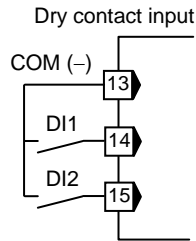

- Digital input from external devices or equipment should be dry contact input. If it is not dry contact input, the input should have meet the specifications below.

Contact specifications: At OFF (contact open) 500 k $\Omega$  or more  
 At ON (contact closed) 10  $\Omega$  or less

- The following functions can be assigned to Digital inputs.

RUN/STOP transfer, Auto/Manual transfer, Interlock release

👉 To assign functions to Digital inputs, refer to **7.5 Engineering Mode (P. 7-80)**.

● **Feedback resistance (FBR) input**

- For Feedback resistance (FBR) input, connect a potentiometer to terminals 16 to 18.

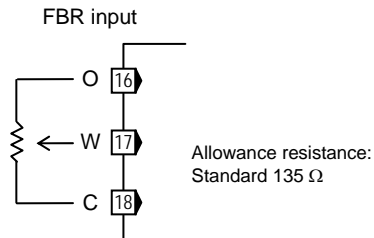

- Feedback resistance (FBR) input is not isolated from the Measured input.



### ■ Optional function: D [Digital input (2 points), Current transformer input (2 points)]

#### ● Digital input (DI1, DI2)

- Terminals 13 through 15 are used for DI1 and DI2.

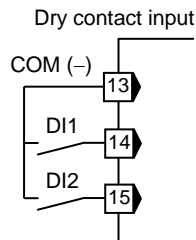

- Digital input from external devices or equipment should be dry contact input. If it is not dry contact input, the input should have meet the specifications below.

Contact specifications: At OFF (contact open) 500 k $\Omega$  or more  
At ON (contact closed) 10  $\Omega$  or less

- The following functions can be assigned to Digital inputs.

RUN/STOP transfer, Auto/Manual transfer, Interlock release

👉 To assign functions to Digital inputs, refer to **7.5 Engineering Mode (P. 7-80)**.

#### ● Current transformer input (CT1, CT2)

- For Current transformer input, connect Current transformers (CT) to terminals 16 to 18.

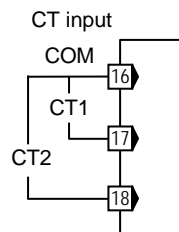

- Current transformer (CT) input is not isolated from the Measured input.

■ **Optional function: E [Communication (1 point), Digital input (3 points)]**

● **Communication 1**

- Terminals 13 through 15 are used for Communication 1.

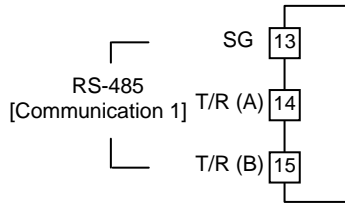

For optional function: E, SG of Communication 1 and COM (-) of Digital input share terminal 13.

- The communication interface is fixed at RS-485.
- The Communication protocol of Communication 1 is either specified by Quick start code 2 when the order is placed, or set in Engineering mode. Communication protocols that can be selected are as follows:

RKC communication (ANSI X3.28-1976 Subcategories 2.5 and A4), Modbus-RTU, Intercontroller communication

👉 For details of RKC communication and Modbus, refer to **FB100 Communication Quick Manual (IMR01W15-E□)** or **FB100/FB400/FB900 Communication Instruction Manual (IMR01W04-E□)**.

👉 For the Intercontroller communication, refer to **6.14 Group Operation by the Intercontroller Communication (P. 6-61)**.

● **Digital input (DI1 to DI3)**

- DI1 to DI3 use terminal 13 and terminals 16 to 18.

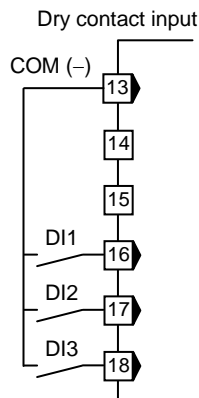

For optional function: E, SG of Communication 1 and COM (-) of Digital input share terminal 13.

- Digital input from external devices or equipment should be dry contact input. If it is not dry contact input, the input should have meet the specifications below.

Contact specifications: At OFF (contact open) 500 kΩ or more  
At ON (contact closed) 10 Ω or less

- The following functions can be assigned to Digital inputs.

Memory area transfer [without area set] (Number of area: 1 to 8),  
RUN/STOP transfer, Remote/Local transfer, Auto/Manual transfer, Interlock release

👉 To assign functions to Digital inputs, refer to **7.5 Engineering Mode (P. 7-80)**.

## ■ Optional function: F [Communication (1 point), Digital input (1 point), Current transformer input (1 point)]

### ● Communication 1

- Terminals 13 through 15 are used for Communication 1.

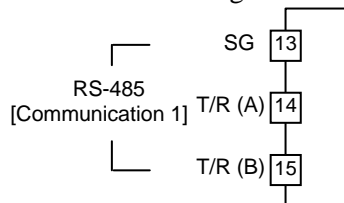

For optional function: F, SG of Communication 1 and COM (-) of Digital input share terminal 13.

- The communication interface is fixed at RS-485.
- The Communication protocol of Communication 1 is either specified by Quick start code 2 when the order is placed, or set in Engineering mode. Communication protocols that can be selected are as follows:

RKC communication (ANSI X3.28-1976 Subcategories 2.5 and A4), Modbus-RTU, Intercontroller communication

📖 For details of RKC communication and Modbus, refer to **FB100 Communication Quick Manual (IMR01W15-E□)** or **FB100/FB400/FB900 Communication Instruction Manual (IMR01W04-E□)**.

📖 For the Intercontroller communication, refer to **6.14 Group Operation by the Intercontroller Communication (P. 6-61)**.

### ● Digital input (DI1)

- Terminal 13 and 16 are used for DI1.

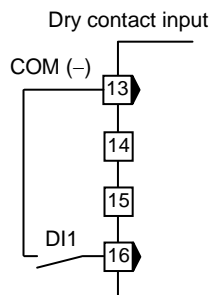

For optional function: F, SG of Communication 1 and COM (-) of Digital input share terminal 13.

- Digital input from external devices or equipment should be dry contact input. If it is not dry contact input, the input should have meet the specifications below.

Contact specifications: At OFF (contact open) 500 k $\Omega$  or more

At ON (contact closed) 10  $\Omega$  or less

- The following functions can be assigned to Digital inputs.

RUN/STOP transfer, Remote/Local transfer, Auto/Manual transfer, Interlock release

📖 To assign functions to Digital inputs, refer to **7.5 Engineering Mode (P. 7-80)**.

### ● Current transformer input (CT1)

- For Current transformer (CT) input, connect a Current transformer (CT) to terminals 17 and 18.

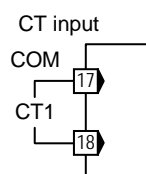

- Current transformer (CT) input is not isolated from the Measured input.

### ■ Optional function: G [Communication (2 points)]

#### ● Communication 1/Communication 2

- Terminals 13 through 15 are used for Communication 1; Terminals 16 through 18 are used for Communication 2.

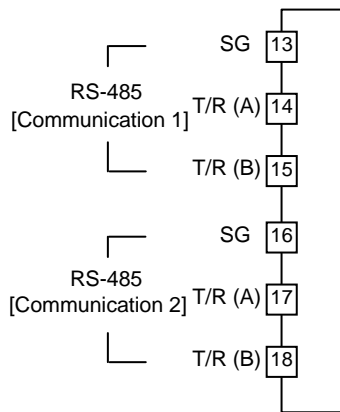

- The communication interface is fixed at RS-485.
- The Communication protocol of Communication 1 is either specified by Quick start code 2 when the order is placed, or set in Engineering mode. Communication protocols that can be selected are as follows:

RKC communication (ANSI X3.28-1976 Subcategories 2.5 and A4), Modbus-RTU

- The Communication protocol of Communication 2 is fixed at Intercontroller communication.
  - For details of RKC communication and Modbus, refer to **FB100 Communication Quick Manual (IMR01W15-E□)** or **FB100/FB400/FB900 Communication Instruction Manual (IMR01W04-E□)**.
  - For the Intercontroller communication, refer to **6.14 Group Operation by the Intercontroller Communication (P. 6-61)**.

## ■ Optional function: H [Communication (1 point), Current transformer input (2 points)]

### ● Communication 1

- Terminals 13 through 15 are used for Communication 1.

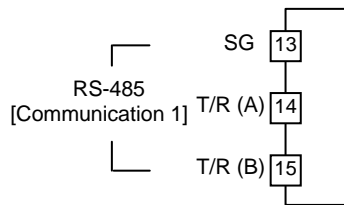

- The communication interface is fixed at RS-485.
- The Communication protocol of Communication 1 is either specified by Quick start code 2 when the order is placed, or set in Engineering mode. Communication protocols that can be selected are as follows:

RKC communication (ANSI X3.28-1976 Subcategories 2.5 and A4), Modbus-RTU, Intercontroller communication

☞ For details of RKC communication and Modbus, refer to **FB100 Communication Quick Manual (IMR01W15-E□)** or **FB100/FB400/FB900 Communication Instruction Manual (IMR01W04-E□)**.

☞ For the Intercontroller communication, refer to **6.14 Group Operation by the Intercontroller Communication (P. 6-61)**.

### ● Current transformer input (CT1, CT2)

- For Current transformer (CT) input, connect Current transformers (CT) to terminals 16 to 18.

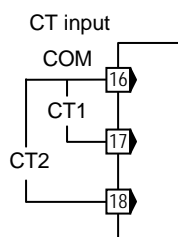

- Current transformer (CT) input is not isolated from the Measured input.

■ **Optional function: J [Communication (1 point), Digital input (1 point), Remote setting input (1 point)]**

● **Communication 1**

- Terminals 13 through 15 are used for Communication 1.

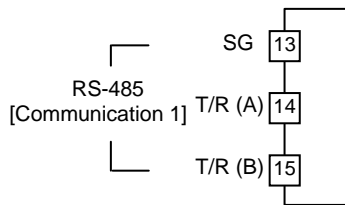

- The communication interface is fixed at RS-485.
- The Communication protocol of Communication 1 is either specified by Quick start code 2 when the order is placed, or set in Engineering mode. Communication protocols that can be selected are as follows:

RKC communication (ANSI X3.28-1976 Subcategories 2.5 and A4), Modbus-RTU, Intercontroller communication

☞ For details of RKC communication and Modbus, refer to **FB100 Communication Quick Manual (IMR01W15-E□)** or **FB100/FB400/FB900 Communication Instruction Manual (IMR01W04-E□)**.

☞ For the Intercontroller communication, refer to **6.14 Group Operation by the Intercontroller Communication (P. 6-61)**.

● **Digital input (DI1)**

- Terminal 13 and 16 are used for DI1.

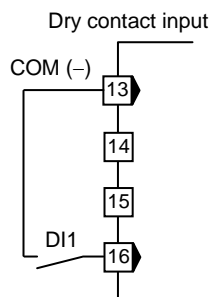

For optional function: J, SG of Communication 1 and COM (-) of Digital input share terminal 13.

- Digital input from external devices or equipment should be dry contact input. If it is not dry contact input, the input should have meet the specifications below.

Contact specifications: At OFF (contact open) 500 kΩ or more  
At ON (contact closed) 10 Ω or less

- The following functions can be assigned to Digital inputs.  
RUN/STOP transfer, Remote/Local transfer, Auto/Manual transfer, Interlock release

☞ To assign functions to Digital inputs, refer to **7.5 Engineering Mode (P. 7-80)**.

- **Remote setting (RS) input**

- Remote setting (RS) input has provided as standard specifications.
- Terminal 17 and 18 are used for Remote setting (RS) input. Connect an input according to the Remote setting (RS) input type\*.

\* The following two methods of the RS input selection are available:

Specify when ordering (Initial setting code)

Setting by Remote setting (RS) input type of Engineering mode (Refer to page 7-79)

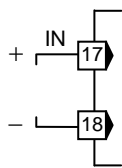

< Initial setting code (Quick start code 2)>

Any one of the following input types can be selected.

Specification code	Input type	Specification code	Input type
1	Voltage input (0 to 10 mV DC)	5	Voltage input (0 to 10 V DC)
2	Voltage input (0 to 100 mV DC)	6	Voltage input (1 to 5 V DC)
3	Voltage input (0 to 1 V DC)	7	Voltage input (0 to 20 mA DC)
4	Voltage input (0 to 5 V DC)	8	Voltage input (4 to 20 mA DC)

- Remote setting (RS) input is not isolated from the Measured input.

■ **Optional function: 3, 4, 5, 6, 7, 8 [Digital input (1 point), Transmission output (1 point), Remote setting input (1 point)]**

● **Digital input (DI1)**

- Terminal 13 and 14 are used for DI1.

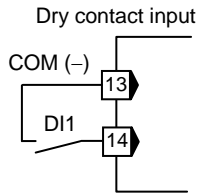

- Digital input from external devices or equipment should be dry contact input. If it is not dry contact input, the input should have meet the specifications below.

Contact specifications: At OFF (contact open) 500 kΩ or more  
At ON (contact closed) 10 Ω or less

- The following functions can be assigned to Digital inputs.

RUN/STOP transfer, Remote/Local transfer, Auto/Manual transfer, Interlock release

☞ To assign functions to Digital inputs, refer to **7.5 Engineering Mode (P. 7-80)**.

● **Remote setting (RS) input**

- Remote setting (RS) input has provided as standard specifications.
- Terminal 15 and 16 are used for Remote setting (RS) input. Connect an input according to the Remote setting (RS) input type\*.

\* The following two methods of the RS input selection are available:

Specify when ordering (Initial setting code)

Setting by Remote setting (RS) input type of Engineering mode (Refer to page 7-79)

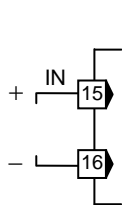

< Initial setting code (Quick start code 2)>

Any one of the following input types can be selected.

Specification code	Input type	Specification code	Input type
1	Voltage input (0 to 10 mV DC)	5	Voltage input (0 to 10 V DC)
2	Voltage input (0 to 100 mV DC)	6	Voltage input (1 to 5 V DC)
3	Voltage input (0 to 1 V DC)	7	Voltage input (0 to 20 mA DC)
4	Voltage input (0 to 5 V DC)	8	Voltage input (4 to 20 mA DC)

- Remote setting (RS) input is not isolated from the Measured input.

● **Transmission output (AO)**

- Terminal 17 and 18 are used for Transmission output (AO).

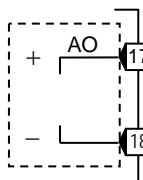

● Wiring example

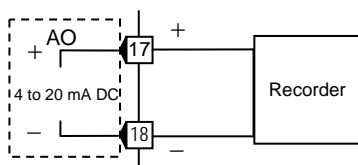

<Initial set code>

Specification code	Output type	Specifications
3	Voltage output	0 to 1 V DC (Load resistance: 1 kΩ or more)
4		0 to 5 V DC (Load resistance: 1 kΩ or more)
5		0 to 10 V DC (Load resistance: 1 kΩ or more)
6		1 to 5 V DC (Load resistance: 1 kΩ or more)
7	Current output	0 to 20 mA DC (Load resistance: 600 Ω or less)
8		4 to 20 mA DC (Load resistance: 600 Ω or less)



# OPERATION MENU AND BASIC OPERATION





- 5.1 Operation Menu .....5-2
- 5.2 Basic Operation .....5-4
  - 5.2.1 Scrolling through parameters .....5-4
  - 5.2.2 Changing set value (SV) .....5-9
  - 5.2.3 Operation of the direct key .....5-10
  - 5.2.4 Data lock function.....5-11

# 5.1 Operation Menu

The controller has five different setting modes. All settable parameters belong to one of them. The following chart shows how to access different setting mode.

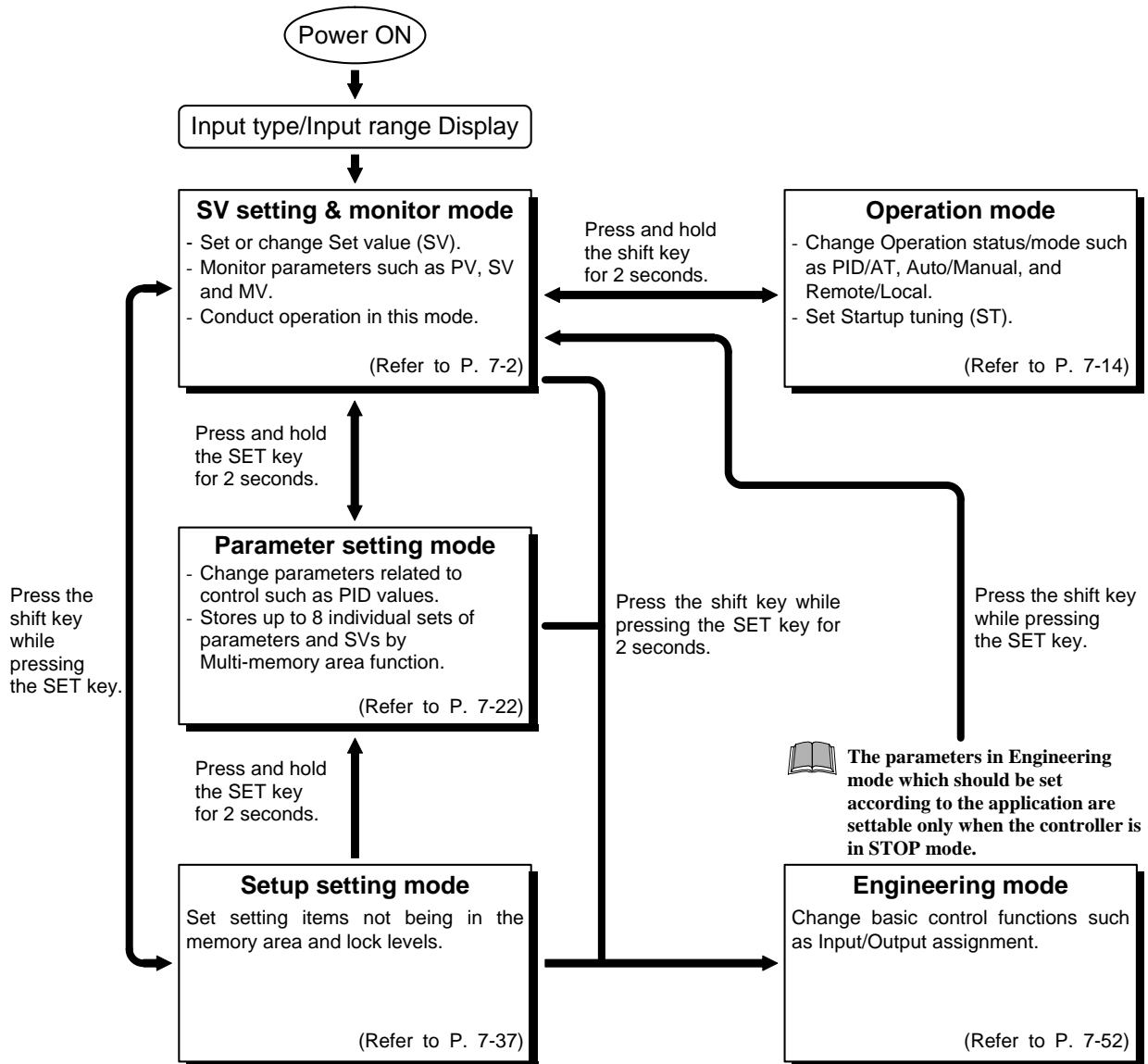
 For the details of key operation, refer to **5.2 Basic Operation (P. 5-4)**.



 Display returns to the SV setting and monitor mode from the Operation mode or the Parameter setting mode by pressing the shift key while pressing the SET key.

 Display returns to the Measured value (PV)/Set value (SV) monitor screen if no key operation is performed within 1 minute (except during the Feedback adjustment).

 Parameters not being specified are not displayed except in the Engineering mode.

## ■ Input type and input range display

This instrument immediately confirms inputs type symbol and input range following power ON.

Example: When sensor type is K thermocouple

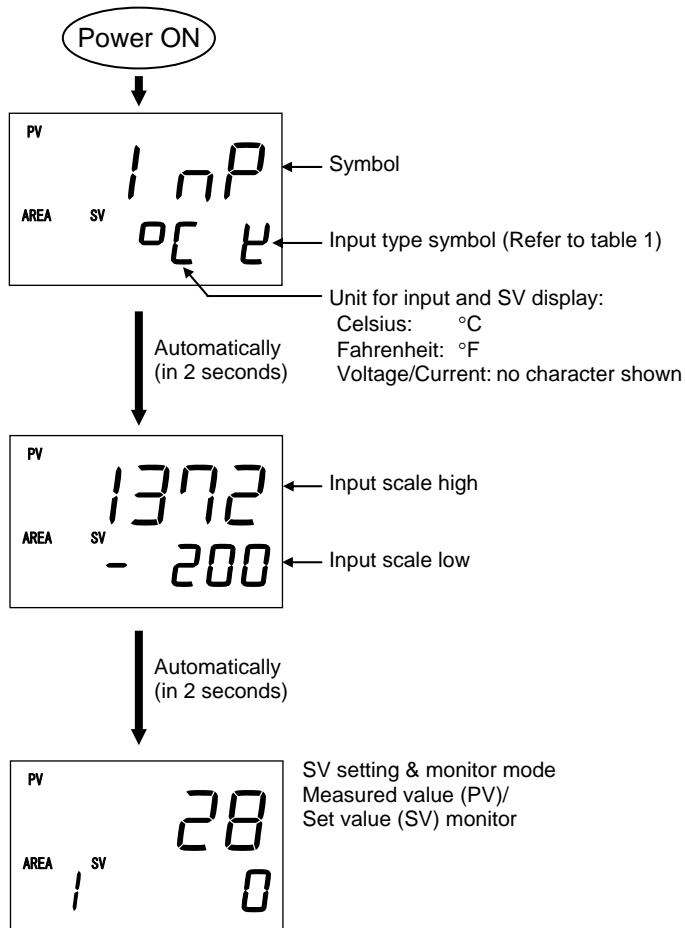

Table 1: Input type symbol table

Symbol	Input type
K	Thermocouple K
J	Thermocouple J
T	Thermocouple T
S	Thermocouple S
R	Thermocouple R
E	Thermocouple E
B	Thermocouple B
N	Thermocouple N
P	Thermocouple PLII
W	Thermocouple W5Re/W26Re
U	Thermocouple U
L	Thermocouple L
Pt	RTD Pt100
JP	RTD JPt100
V	Voltage (mV, V)
I	Current (mA)

# 5.2 Basic Operation

Basic key operations common to each mode (set item change, set value change and registration) and Data lock function are described in the following.

## 5.2.1 Scrolling through parameters

### ■ SV setting & monitor mode

Operation method for SV setting & monitor mode differs depending on the Direct key type. Direct key types include Auto/Manual transfer, Monitor, Memory area transfer, Remote/Local transfer and RUN/STOP transfer. The operation of Monitor differs from the other types.

 The Direct key type can be selected in Engineering mode.  
(Factory set value: Auto/Manual transfer)

 For details of SV setting & monitor mode, refer to **7.1 SV Setting & Monitor Mode (P. 7-2)**.

#### ● When the direct key type is Auto/Manual transfer:

The monitor screen, setting screens, and memory area transfer screen appear together.

- Pressing the SET key enables the selection of only setting screens in SV setting & monitor mode.
- To go back to the first parameter, keep pressing SET keys until it is displayed again.
- Press the Direct key to switch between Auto mode and Manual mode.

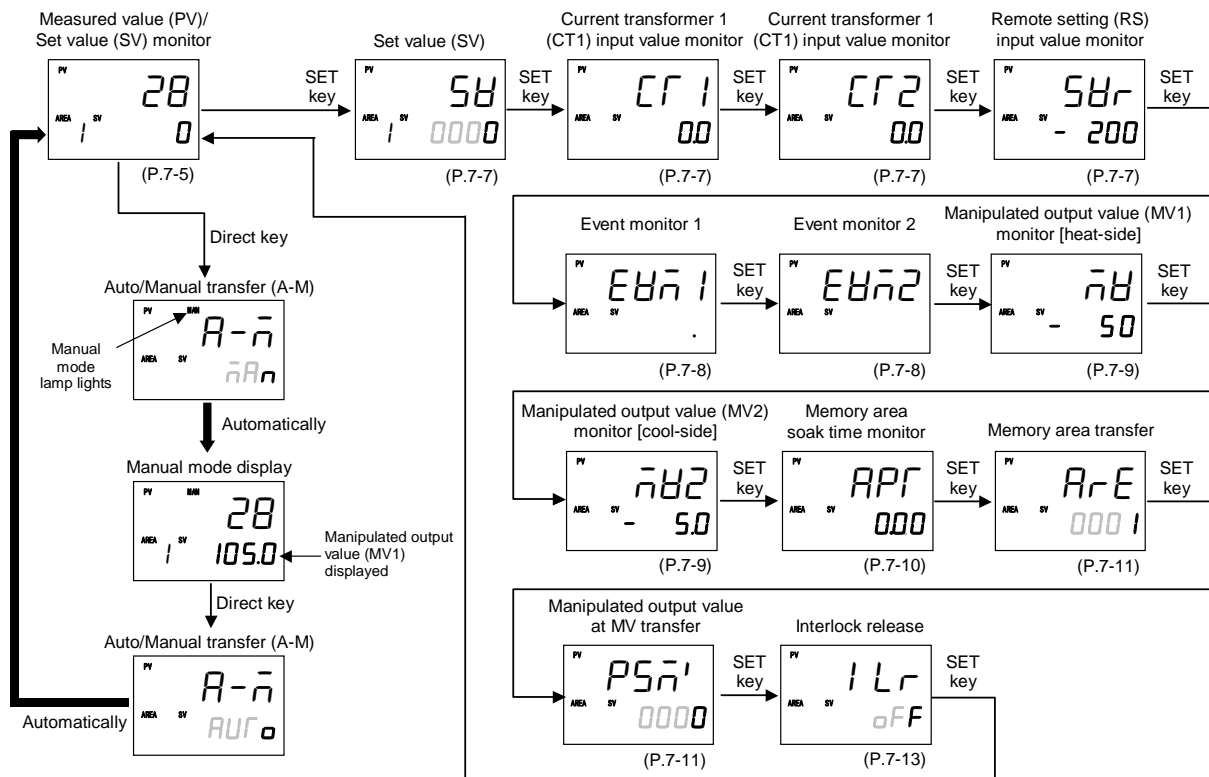

● **When the direct key type is Monitor:**

The monitoring, setting and memory area transfer screen are mixedly displayed.

- Pressing the SET key enables screen selection.
- To go back to the first parameter, keep pressing SET keys until it is displayed again.
- The monitor screen can be changed by pressing the Direct key.

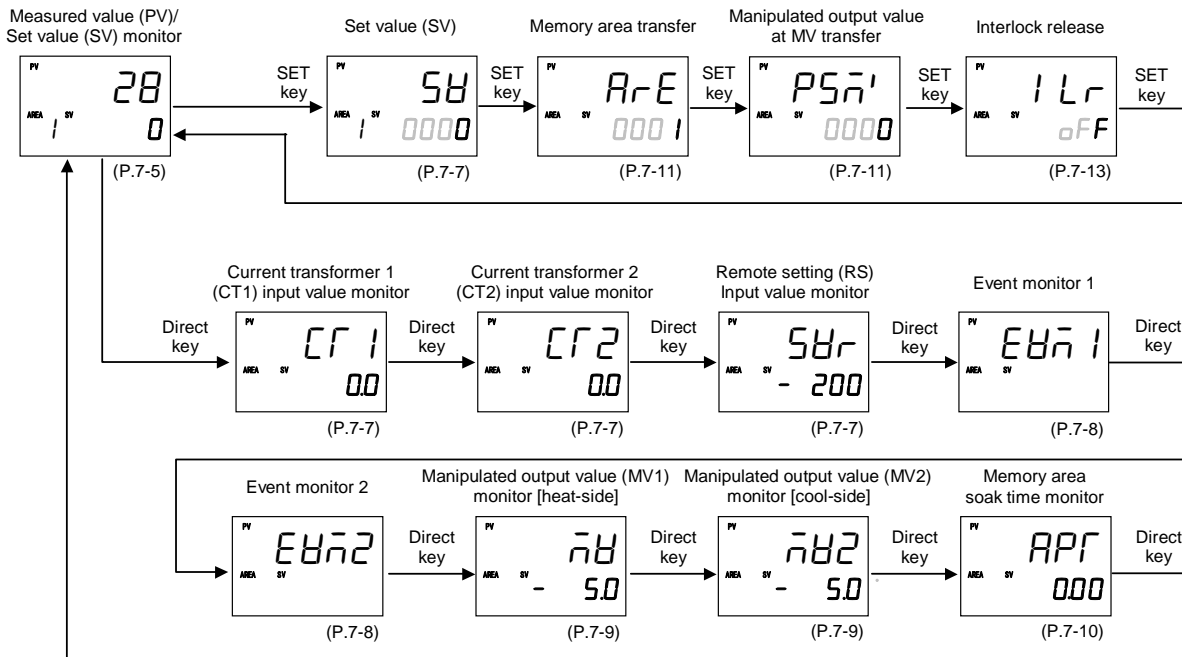

● **When the direct key type is Memory area transfer:**

- The screens when the SET key is pressed are the same as for Auto/Manual transfer (Refer to P. 5-4).
- When the Direct key is pressed, the memory area transfer screen appears. Press the SET key to return to the Measured value (PV)/Set value (SV) monitor screen.

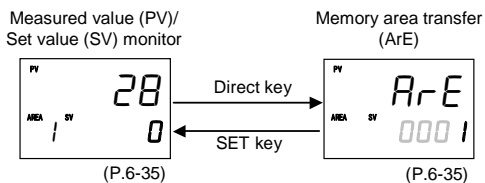

● **When the direct key type is Remote/Local transfer:**

- The screens when the SET key is pressed are the same as for Auto/Manual transfer (Refer to P. 5-4).
- Press the Direct key to switch between Remote mode and Local mode.

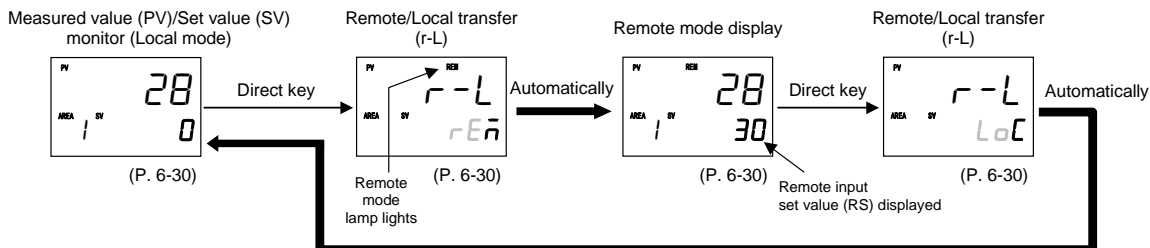

● **When the direct key type is RUN/STOP transfer:**

- The screens when the SET key is pressed are the same as for Auto/Manual transfer (Refer to P. 5-4).
- Press the Direct key to switch between RUN (control start) and STOP (control stop).

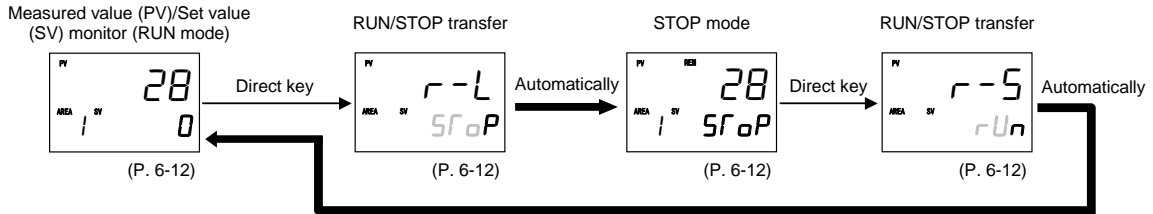

■ **Parameter setting mode, Setup setting mode**

- Press to scroll through parameters in the same Mode/Area.
- To go back to the first parameter, keep pressing SET keys until it is displayed again.
- When the Direct key type is Monitor, pressing the Direct key changes the screen to the Measured value (PV)/Set value (SV) monitor screen.

**Parameter setting mode**

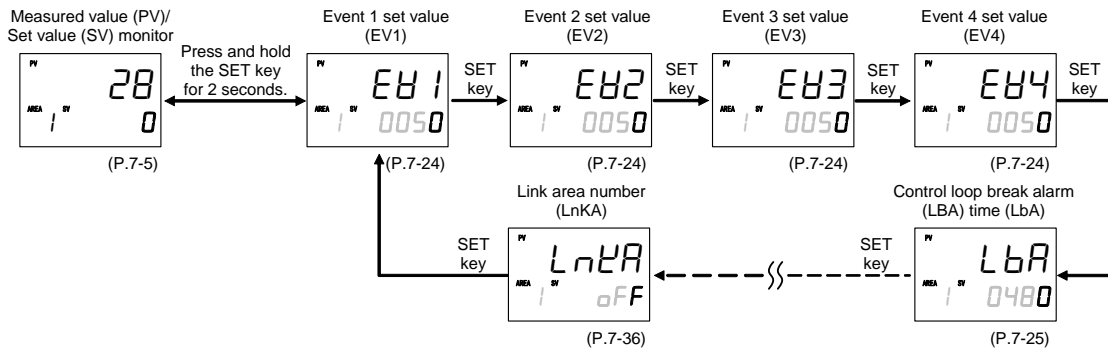

☞ For details of the Parameter setting mode, refer to **7.3 Parameter Setting Mode (P. 7-22)**.

**Setup setting mode**

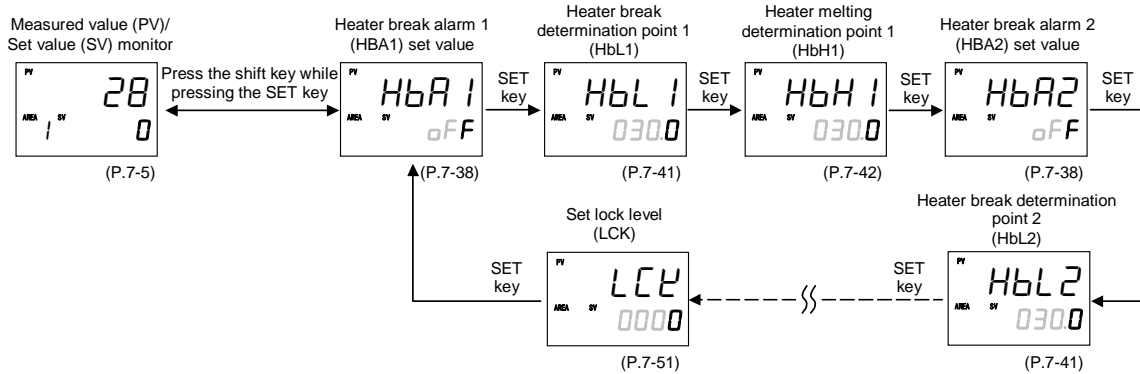

☞ For details of the Setup setting mode, refer to **7.3 Setup Setting Mode (P. 7-37)**.

## ■ Operation mode

- Pressing the shift or SET key enables screen selection.
- To go back to the first parameter, keep pressing shift keys until it is displayed again.
- Pressing the UP or DOWN key enables Operation mode selection.
- When the Direct key type is Monitor, pressing the direct key changes the screen to the Measured value (PV)/Set value (SV) monitor screen.

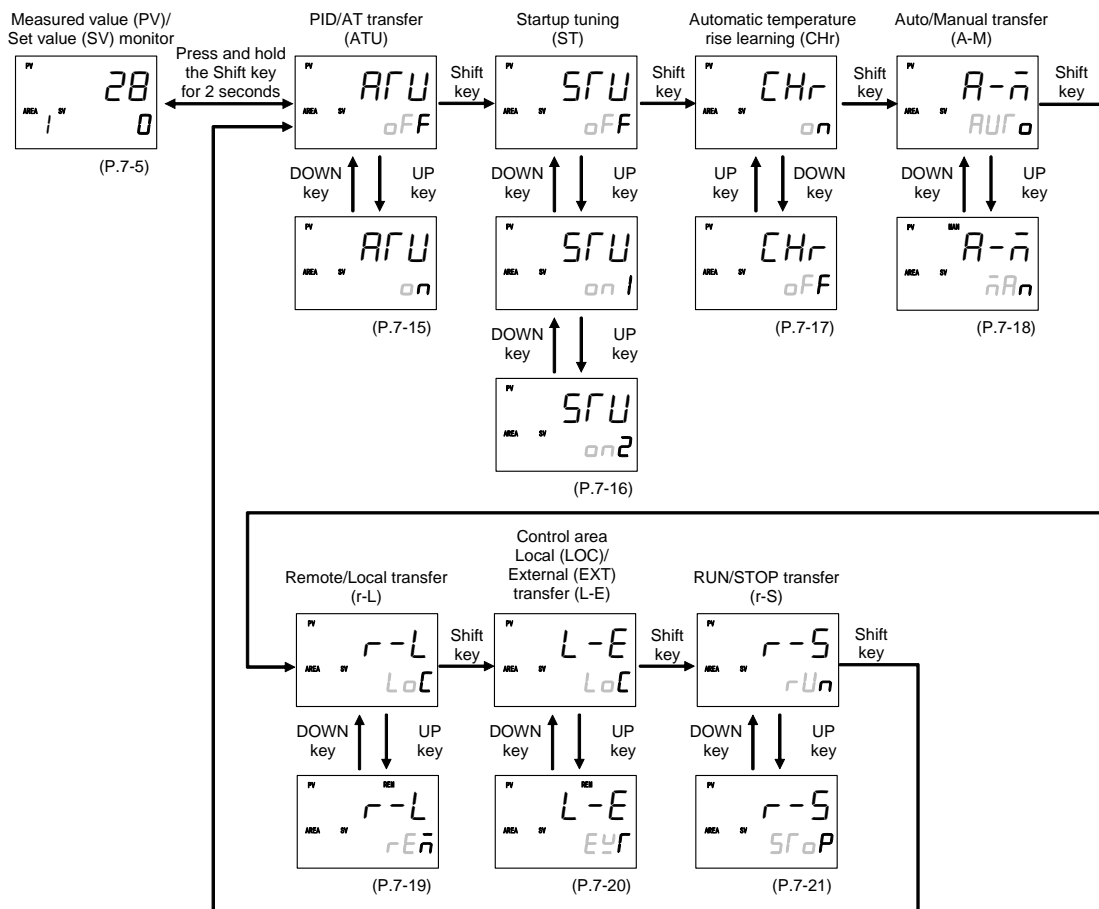

Transferring the Operation mode immediately performs control in the mode transferred.



For details of the Operation mode, refer to **7.2 Operation Mode (P. 7-14)**.

### ■ Engineering mode

- Pressing the UP or DOWN key enables function block selection.
- Pressing the SET key enables parameter selection.
- To go back to the first parameter, keep pressing UP or DOWN keys until it is displayed again.
- When the Direct key type is Monitor, pressing the direct key changes the screen to the Measured value (PV)/Set value (SV) monitor screen.

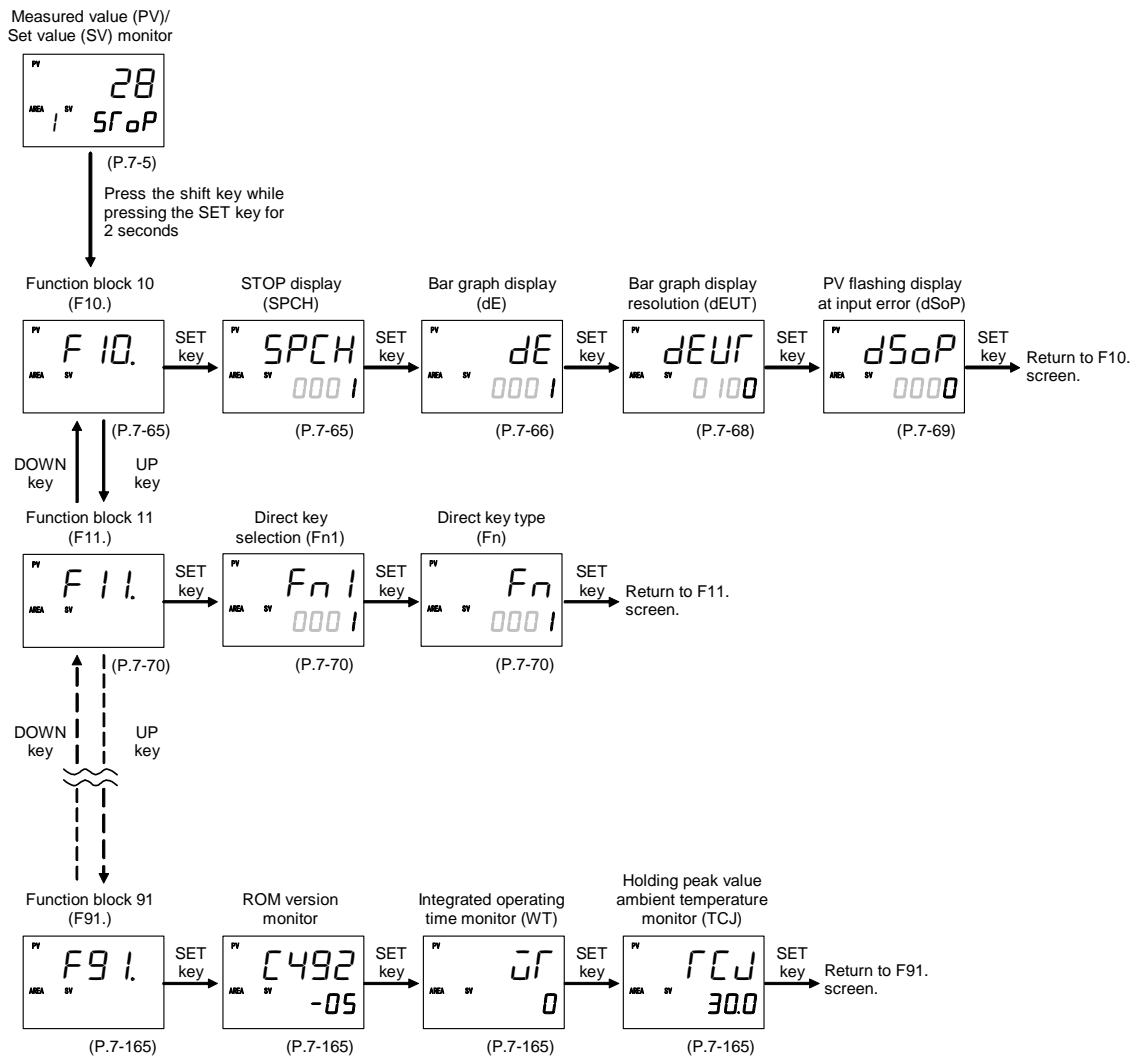

For details of the Engineering mode, refer to **7.5 Engineering Mode (P. 7-52)**.



## 5.2.2 Changing set value (SV)

- The high-lighted digit indicates which digit can be set. Press Shift key to go to a different digit. Every time the shift key is pressed, the high-lighted digit moves as follows.



- The following is also available when changing the set value.

### Increase SV from 199 °C to 200 °C:

- Press the shift key to light brightly the ones place (first digit from the right).
- Press the UP key to change to 0.  
The display changes to 200.

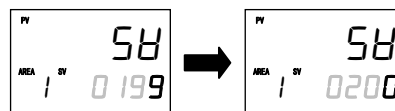

### Decrease SV from 200 °C to 190 °C:

- Press the shift key to light brightly the tens place.
- Press the DOWN key to change to 9.  
The display changes to 190.

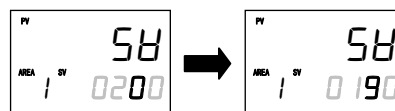

### Decrease SV from 200 °C to -100 °C:

- Press the shift key to light brightly the hundreds place.
- Press the DOWN key (three times) to change to -1.  
The display changes to -100.

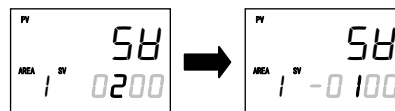

- To store a new value for the parameter, always press the SET key.** The display changes to the next parameter and the new value will be stored.



A new value will not be stored without pressing SET key after the new value is displayed on the display.



After a new value has been displayed by using the UP and DOWN keys, the SET key must be pressed within 1 minute, or the new value is not stored and the display will return to the Measured value (PV)/Set value (SV) monitor screen.

### 5.2.3 Operation of the direct key

#### ■ Direct key type

The FB100 has one Direct key, and the Direct key type can be selected in Engineering mode. (Refer to P. 7-70)

The Direct key types are Auto/Manual transfer, Monitor, Memory area transfer, Remote/Local transfer and RUN/STOP transfer. The factory default setting is Auto/Manual transfer. If you set the Direct key to a different type, affix the provided label to the front of the instrument.

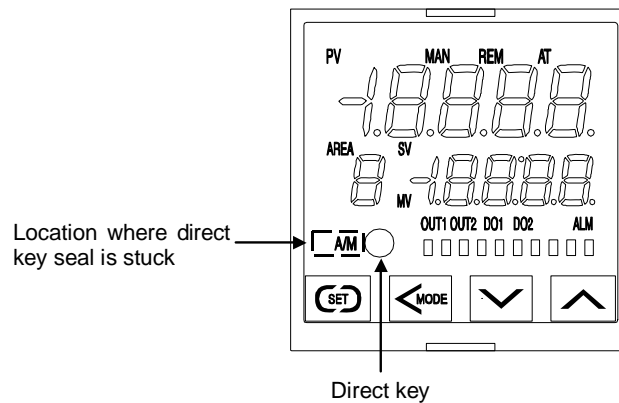

Direct key operation is valid in all setting modes (SV setting & monitor mode, Parameter setting mode, Setup setting mode, Operation mode, and Engineering mode).



For additional information on operation of the direct key, refer to ■ **SV setting & monitor mode (P. 5-4)**.

#### ■ How to restrict operation of the direct keys

To prevent accidental operation, the Direct key can be disabled. The setting is configured in Engineering mode (function block 11). (Refer to P. 7-70.)

## 5.2.4 Data lock function

The Data lock function limits access of unauthorized personnel to the parameters and prevents parameter change by mistake.

There are 8 set data lock levels. The set Data lock level can be set in Setup setting mode.

Character display	Parameters which can be changed	Set value
	All parameters [Factory set value]	0000
	<ul style="list-style-type: none"> <li>• Set value (SV)</li> <li>• Event set value (EV1 to EV4)</li> <li>• Memory area transfer</li> <li>• Manipulated output value at MV transfer</li> <li>• Parameters in operation mode</li> <li>• Parameters in F10 through F91 (Engineering mode)</li> </ul>	0001
	All parameters except for Event set value 1 (EV1) to Event set value 4 (EV4)	0010
	Set value (SV)	0011
	All parameters except for Set value (SV)	0100
	Event set value (EV1 to EV4)	0101
	All parameters except for Set value (SV) and Event set value (EV1) to Event set value (EV4)	0110
	No parameter (All Locked)	0111



Data lock level can be changed in both RUN and STOP mode.



Parameters protected by Data lock function are still displayed for monitoring.

# MEMO

# OPERATION

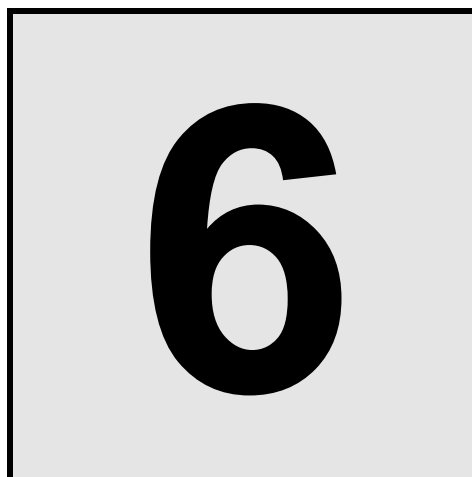

6.1	Operating Precautions.....	6-2
6.2	Monitoring Display in Operation .....	6-3
6.3	Operating Setting .....	6-5
6.3.1	Set the Set value (SV).....	6-5
6.3.2	Set the Event set value (alarm set value) .....	6-7
6.3.3	Autotuning (AT) start .....	6-8
6.4	RUN/STOP Transfer .....	6-11
6.5	Autotuning (AT) .....	6-15
6.6	Startup Tuning (ST).....	6-18
6.7	Auto/Manual Transfer.....	6-23
6.8	Remote/Local Transfer.....	6-29
6.9	Control Area Transfer.....	6-33
6.10	Interlock Release.....	6-39
6.11	Start Action at Recovering Power Failure.....	6-42
6.12	Position Proportioning PID Control.....	6-43
6.13	Ramp/Soak Control.....	6-52
6.14	Group Operation by the Intercontroller Communication .....	6-61
6.14.1	Wiring method of the Intercontroller communication .....	6-61
6.14.2	Common setting of the Intercontroller communication .....	6-62
6.14.3	Group RUN/STOP function .....	6-64
6.14.4	Automatic temperature rise function (with learning function) .....	6-72
6.14.5	Cascade control function.....	6-81
6.14.6	Ratio setting function.....	6-89

# 6.1 Operating Precautions

---

Check the following items before starting operation, then turn on the power.

## ■ Power ON

There is no power switch on this instrument, and the instrument starts operation immediately following initial power ON (Factory set value: RUN).

## ■ Action at input error

If the input signal wiring is disconnected or short-circuited (RTD input only), the instrument determines that burnout has occurred.

### ● Burnout direction

Upscale: Thermocouple input<sup>1</sup>, RTD input (at input break), Voltage (low) input

Downscale: Thermocouple input<sup>1</sup>, RTD input (at short-circuited), Voltage (low) input, Voltage (high) input<sup>2</sup>, Current input<sup>2</sup>

<sup>1</sup>For the Thermocouple input, upscale or downscale can be selected by Engineering mode. (Factory set value: Upscale)

<sup>2</sup>For the Voltage (high) input or the Current input, the display becomes indefinite (display of about zero value).

### ● Output at input error

Control output: According to the contents set by Action (high/low) at input error

Event output: According to the contents set by Event action at input error

## ■ Checking the each parameter

The settings for the SV and all parameters should be appropriate for the controlled system.

There are parameters in Engineering mode which can not be changed when the controller is in RUN mode. Change the RUN/STOP mode from RUN to STOP when a change for the parameters in Engineering mode is necessary.

 For details of the each parameter, refer to **7. DESCRIPTION OF EACH PARAMETER (P. 7-1)**.

 For details of RUN/STOP transfer, refer to **6.4 RUN/STOP Transfer (P. 6-11)**.

 For details of the parameter in Engineering mode, refer to **7.5 Engineering Mode (P. 7-52)**.

## ■ Operation when power failure

A power failure of 20 ms or less will not affect the control action. When a power failure of more than 20 ms occurs the instrument assumes that the power has been turned off. When the power returns, the operation of instrument will be re-starts in accordance with the content selected by Hot/Cold start.

 For details of Hot/Cold start, refer to **6.11 Start Action at Recovering Power Failure (P. 6-42)**.

## ■ Event hold action

- The event hold action is activated when the power is turned on or when transferred from STOP mode to RUN mode.
- The event re-hold action is activated when not only the SV is changed, but also the power is turned on or when transferred from STOP mode to RUN mode.

## 6.2 Monitoring Display in Operation

In SV setting & Monitor mode, the following operations are possible.

When the power is turned on, the controller goes to this mode after self-diagnostics. Use this mode during normal operation. Selection method of monitor screens for SV setting & monitor mode differs depending on the Direct key type (Monitor and except for Monitor).



The factory set value of the Direct key type is Auto/Manual transfer.



For the Direct key operation, refer to **5.2.3 Operation of the direct key (P. 5-10)**.

### ■ When the Direct key type is other than Monitor

- Pressing the SET key enables the selection of screens.
- Monitor screens, Setting screens, and Memory area screen can be displayed.
- To go back to the first parameter, keep pressing SET keys until it is displayed again.

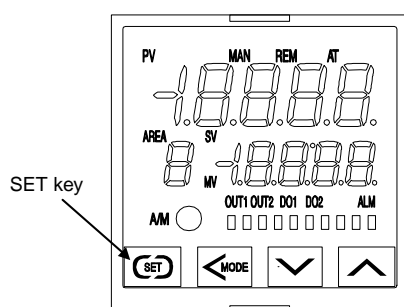

- Display sequence of SV setting & monitor mode:

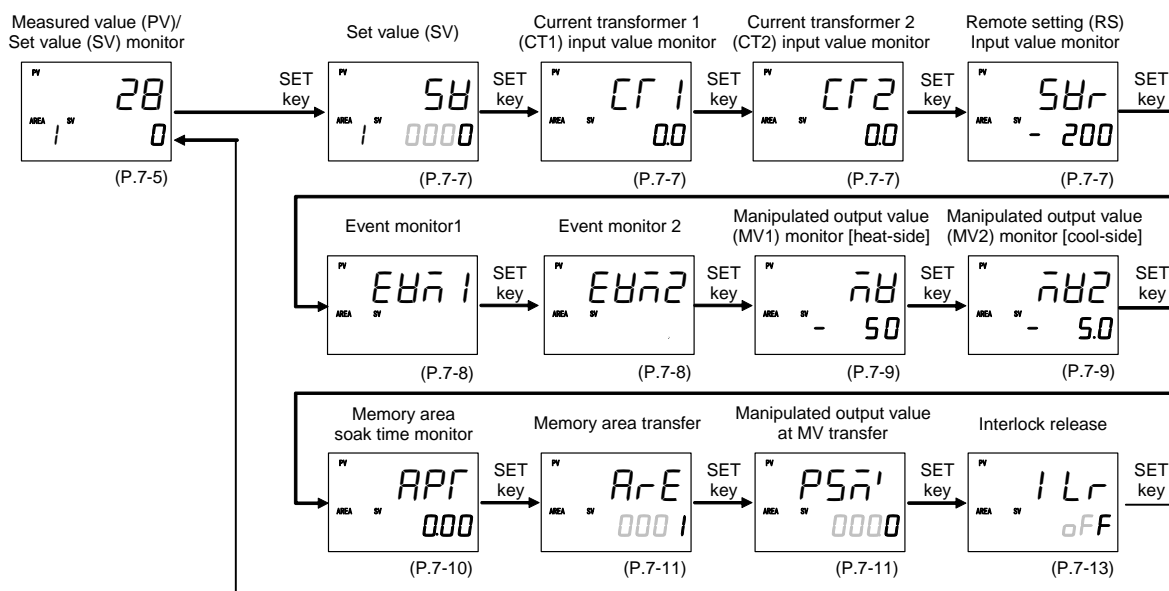

For the content of each screen, refer to **7.1 SV setting & Monitor Mode (P. 7-2)**.



Parameters which are not related to existing functions on the controller or not specified functions are not displayed.

■ When the Direct key type is Monitor

- Pressing the SET key enables the selection of screens.
- Pressing the Direct key enables the selection of Monitor screens.
- To go back to the first parameter, keep pressing SET keys until it is displayed again.

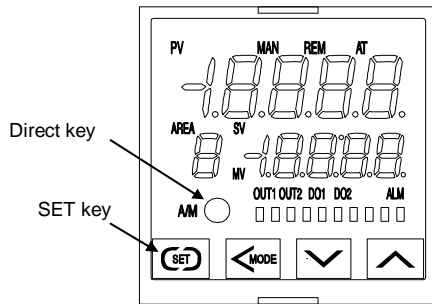

- Display sequence of SV setting & monitor mode:

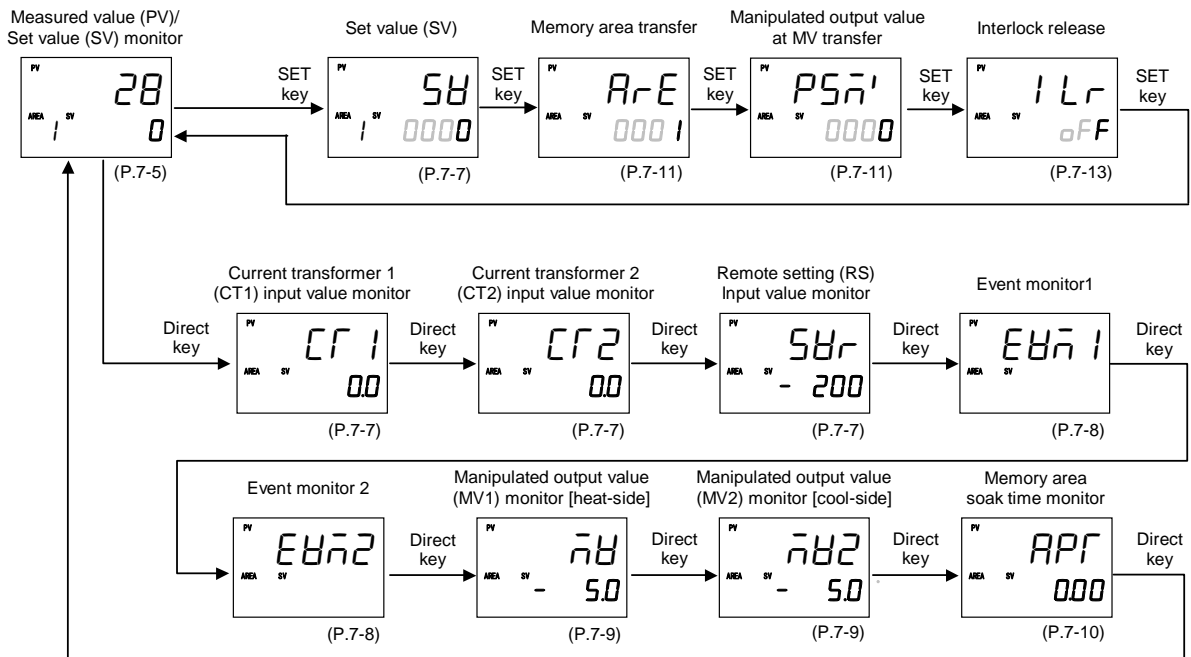

For the content of each screen, refer to **7.1 SV setting & Monitor Mode (P. 7-2)**.



Parameters which are not related to existing functions on the controller or not specified functions are not displayed.



## 6.3 Operating Setting

An example of performing operation with SV set to 200 °C and event 1 set value [deviation high] set to 20 °C is shown in the following.

### ■ Operation procedures

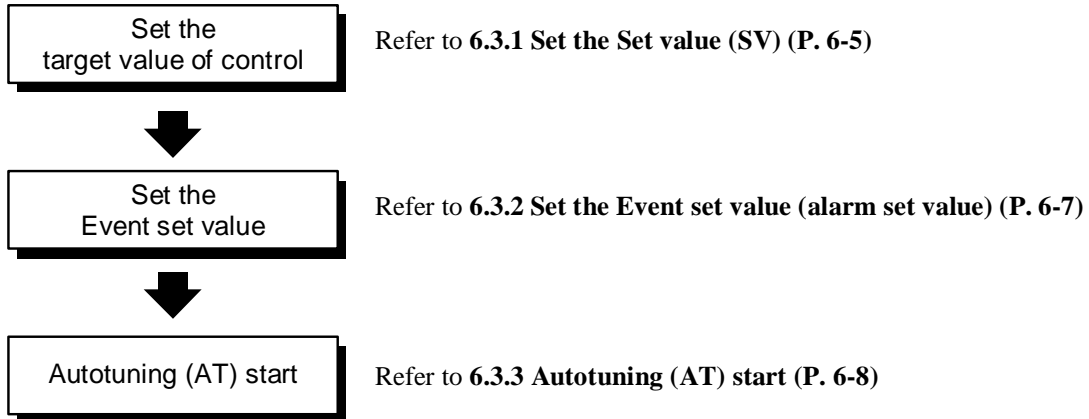

### 6.3.1 Set the Set value (SV)

Example: Change the target value of the control to 200 °C

#### 1. Select the Set value (SV) screen

Press the SET key at PV/SV monitor screen until Set value (SV) screen is displayed.

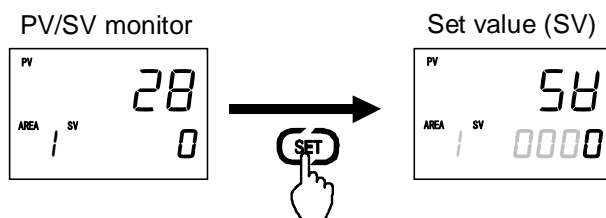

#### 2. Change the Set value (SV)

The set value is set to 200 °C by using the Shift and UP keys. The high-lighted digit indicates which digit can be set.

- ① Press the Shift key to high-light the hundreds digit.
- ② Press the UP key to change the number to 2.

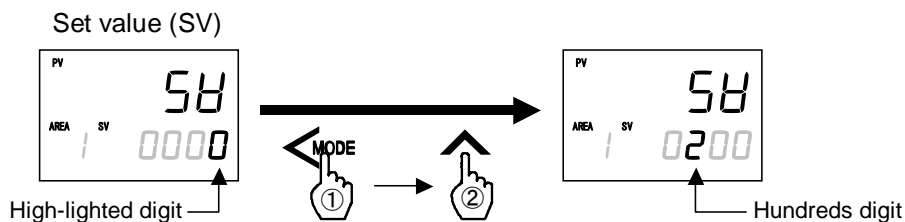

### 3. Store the set value (SV)

Press the SET key to store the new Set value (SV). The screen goes to the next parameter.

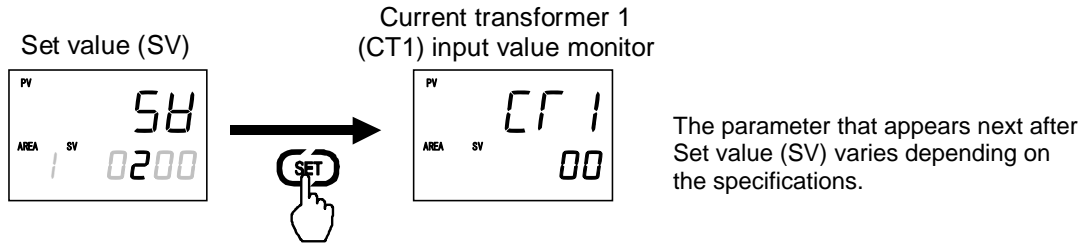

After a new value is displayed on the display by using UP and DOWN keys, if no key operation is performed within 1 minute without pressing SET key, this instrument returns to the PV/SV monitor screen and the Set value (SV) will not be changed.

### 4. Return the PV/SV monitor

To return the PV/SV monitor, press the SET key several times.

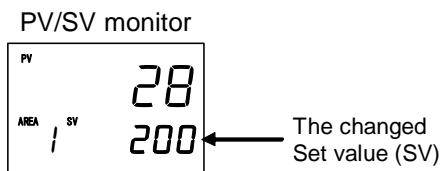

When the memory area number is selected and set the Set value (SV)

Example: Setting the target value of memory area 2 control to 200 °C

- ① In the Set value (SV) screen, press the shift key to highlight the memory area display digit.
- ② Press the up key to set the memory area number to “2”.

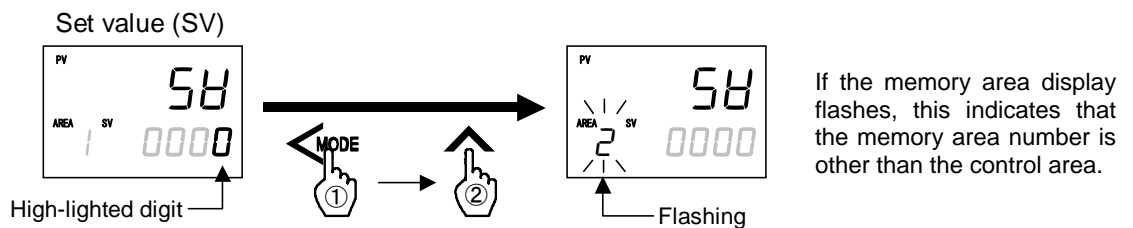

- ③ Press the Shift key to high-light the hundreds digit.
- ④ Press the UP key to change the number to 2.

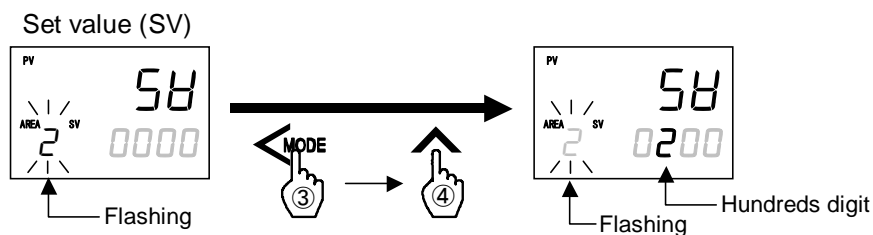

- ⑤ Press the SET key to store the new Set value (SV).

## 6.3.2 Set the Event set value (alarm set value)

Example: Change the Event 1 set value (EV1) to 20 °C

### 1. Select the Event 1 set value (EV1) screen

Press and hold the SET key for 2 seconds at PV/SV monitor screen until Parameter setting mode is displayed. Event 1 set value (EV1) is displayed first.

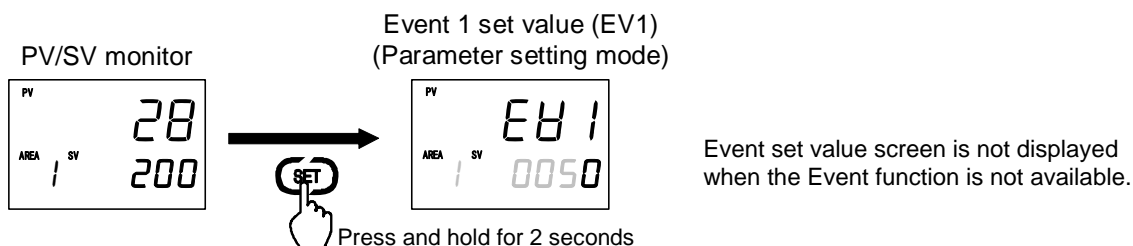

### 2. Change the Event 1 set value (EV1)

The Event 1 set value (EV1) is set to 20 °C by using the Shift and DOWN keys. The high-lighted digit indicates which digit can be set.

- ① Press the Shift key to high-light the tens digit.
- ② Press the DOWN key to change the number to 2.

Event 1 set value (EV1)

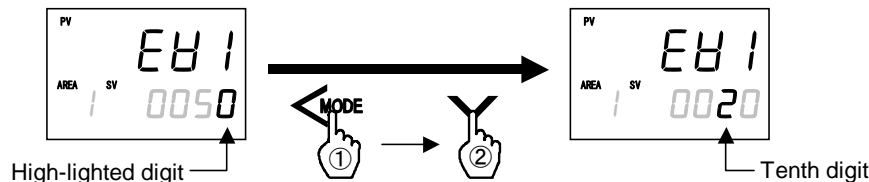

### 3. Store the new Event 1 set value (EV1)

Press the SET key to store the new Event 1 set value (EV1). The screen goes to the next parameter.

Event 1 set value (EV1)

Event 2 set value (EV2) [When the Event 2 is used]

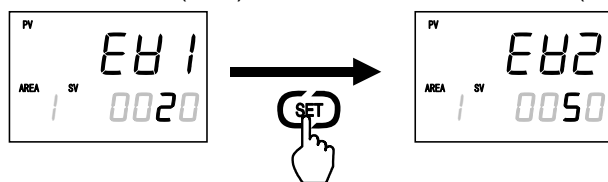

After a new value is displayed on the display by using UP and DOWN keys, if no key operation is performed within 1 minute without pressing SET key, this instrument returns to the PV/SV monitor screen and the Event 1 set value (EV1) will not be changed.

### 4. Return the PV/SV monitor

To return the PV/SV monitor, press and hold the SET key for 2 seconds.



For details of the Event function, refer to **7.5 Engineering Mode (P. 7-88 to P. 7-111)**.

### 6.3.3 Autotuning (AT) start

Autotuning (AT) automatically measures, computes and sets the optimum PID values.

-  Check that all of the requirements for AT start are satisfied before starting operation (refer to P. 6-15). To start Autotuning (AT), go to PID/AT transfer in Operation mode.

#### 1. Select the PID/AT transfer screen

Press and hold the Shift key for 2 seconds at PV/SV monitor screen until Operation mode is displayed. PID/AT transfer screen is displayed first.

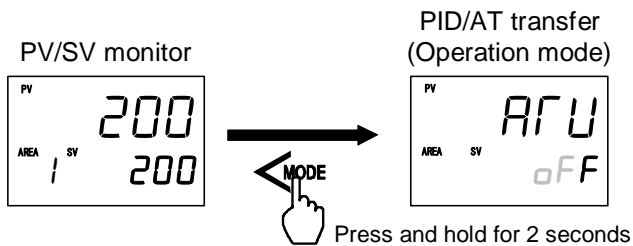

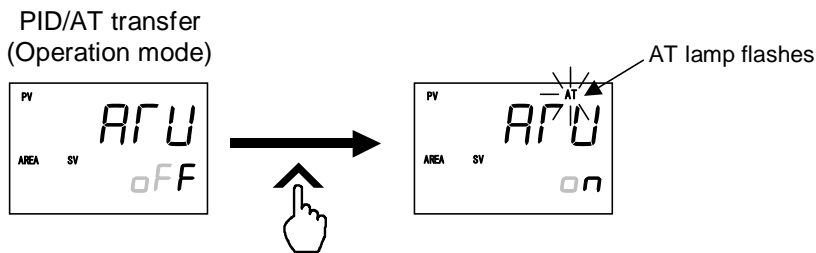

#### 2. Start the autotuning (AT)

If set to “on” by pressing the UP key, the Autotuning function (AT) starts. At this time, the AT lamp flashes.



#### 3. Autotuning (AT) finish

When the Autotuning (AT) is finished, the control will automatically return to PID control. At this time, the AT lamp turns off.

-  When canceling the Autotuning function (AT), press the DOWN key to be set to “oFF.”
-  To return the PV/SV monitor, press and hold the Shift key for 2 seconds.
-  If Autotuning (AT) ends normally, the LBA time is automatically set twice as large as the Integral time.

## ■ To manually set PID values

If the autotuning function does not match the controlled object requirements, the optimum PID values may not be computed by Autotuning (AT). In that case, adjust the PID values manually.

### ● Setting procedure

#### 1. Select the parameter setting mode

Press and hold the SET key for 2 seconds at PV/SV monitor screen until Parameter setting mode is displayed. Event 1 set value (EV1) is displayed first.

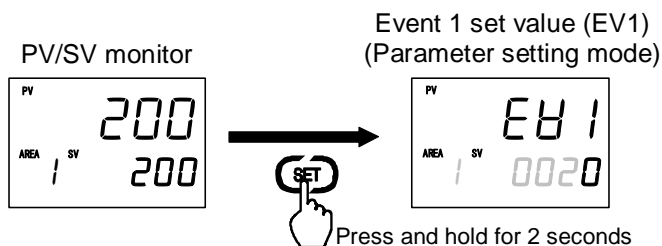

Event set value screen is not displayed when the Event function is not available.

#### 2. Select the proportional band [heat-side] screen

Press the SET key several times to change to the Proportional band [heat-side] screen.

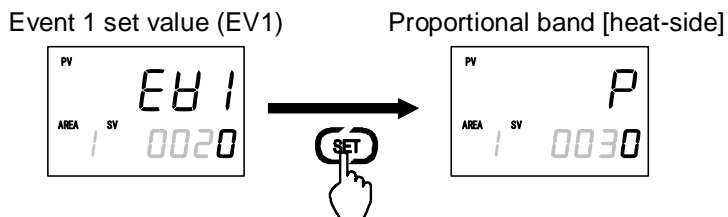

#### 3. Change the Proportional band [heat-side] set value

The Proportional band [heat-side] set value is set to 10 °C by using the Shift and DOWN keys (Example: 10 °C). The high-lighted digit indicates which digit can be set.

- ① Press the Shift key to high-light the tens digit.
- ② Press the DOWN key to change the number to 1.

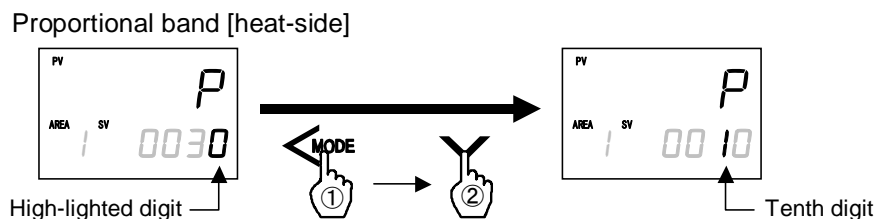

#### 4. Store the Integral time [heat-side] set value

Press the SET key to store the new Proportional band [heat-side] set value. The screen goes to the next Integral time [heat-side].

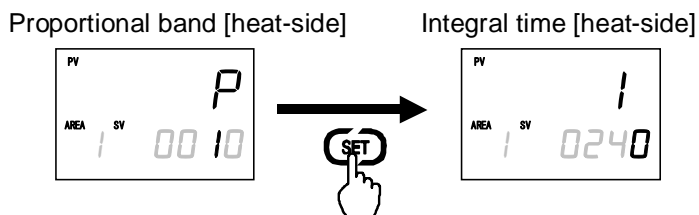

After a new value is displayed on the display by using UP and DOWN keys, if no key operation is performed within 1 minute without pressing SET key, this instrument returns to the PV/SV monitor screen and the Proportional band [heat-side] set value will not be changed.

---

### 5. Set the Integral time [heat-side] and Derivative time [heat-side]

The setting procedure applies when the Integral time [heat-side] and the Derivative time [heat-side] are also set.

Integral time [heat-side]

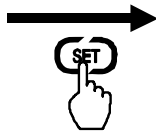

Derivative time [heat-side]



### 6. Return the PV/SV monitor

To return the PV/SV monitor, press and hold the SET key for 2 seconds.



For the setting range of PID values, refer to **7.3 Parameter Setting Mode (P. 7-27 and P. 7-28)**.

## 6.4 RUN/STOP Transfer

The RUN/STOP transfer can be made by Digital input (optional) or Communication (optional) other than the key operation.

 **When the digital input RUN/STOP transfer function is used, it is impossible to transfer RUN/STOP through key operation if the contact is not closed. (When contact opens: STOP mode is maintained.)**

 For details of the RUN/STOP transfer by Communication, refer to the separate **FB100/FB400/FB900 Communication Instruction Manual (IMR01W04-E□)**.

### ● State of this instrument when set to STOP mode

STOP display	Displays the STOP symbol “SToP” on the SV or PV displays. (Factory set value: SV displays)	
Control output	PID control	Output depending on the Manipulated output value (MV1) at STOP mode (Factory set value: -5.0 %)
	Heat/Cool PID control	Heat-side: Output depending on the Manipulated output value (MV1) at STOP mode (Factory set value: -5.0 %) Cool-side: Output depending on the Manipulated output value (MV2) at STOP mode (Factory set value: -5.0 %)
	Position proportioning PID control	When there is no Feedback resistance (FBR) input: Conform to the set value of the Valve action at STOP mode. When there is Feedback resistance (FBR) input: Manipulated output value (MV) at STOP mode corresponds to Feedback resistance (FBR) input value. When there is Feedback resistance (FBR) input, and it is input break: Conform to the set value of the Valve action at STOP mode.
Event output	Output depending on the output status at STOP mode (Factory set value: OFF)	
HBA output		
Transmission output		

 For the settings of STOP display, Output status at STOP mode, and Manipulated output value (MV) at STOP mode, refer to **7.5 Engineering Mode (P. 7-65, P. 7-85 and P. 7-132)**.

### ● State of this instrument when set to RUN mode

Operation when transferred to RUN from STOP is in accordance with the Hot/Cold start selection setting.

 For the Hot/Cold start selection, refer to **6.11 Start Action at Recovering Power Failure (P. 6-42)**.

### ■ RUN/STOP transfer by Front key operation

1. Press and hold the SET key for 2 seconds at PV/SV monitor screen until Operation mode is displayed.

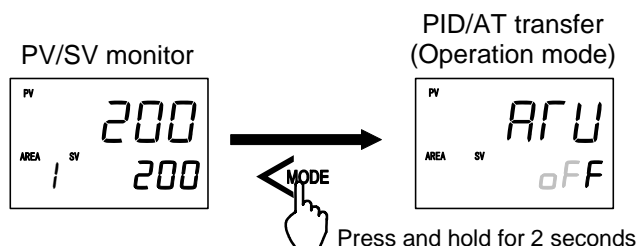

- Press the Shift key several times until RUN/STOP transfer screen is displayed.

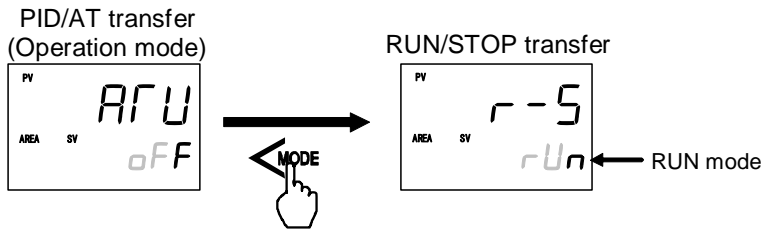

- Pressing the UP key changes to STOP mode from RUN mode.

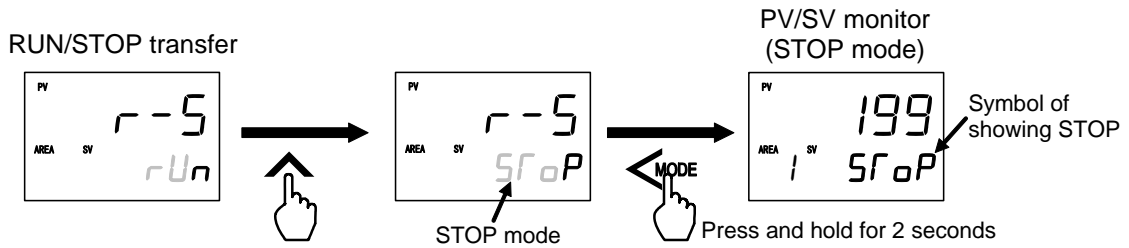

- To change from STOP mode to RUN mode, press the DOWN key.

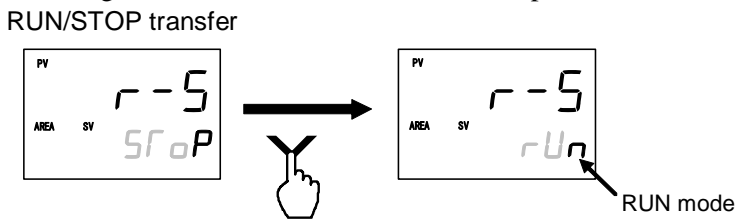

### ■ RUN/STOP transfer by Direct key operation

RUN/STOP transfer by the Direct key is possible with the Direct key type of the Engineering mode. Set "RUN/STOP transfer" to the Direct key type.

Every time the direct key is pressed, the RUN mode is changed to the STOP mode alternately.

For the Direct key type selection, refer to **7.5 Engineering Mode (P. 7-70)**.

- To change from RUN mode to STOP mode

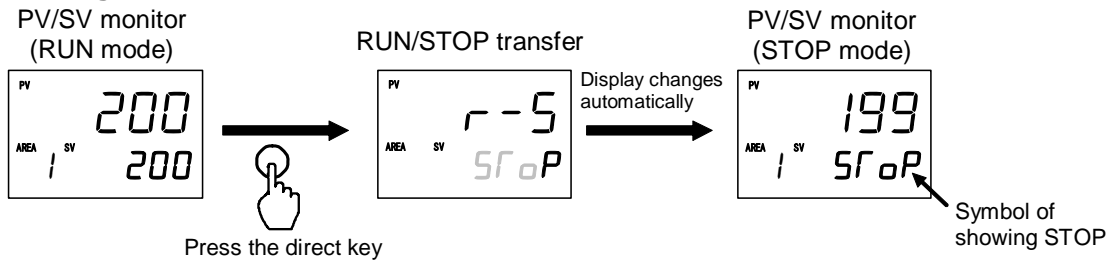

- To change from STOP mode to RUN mode

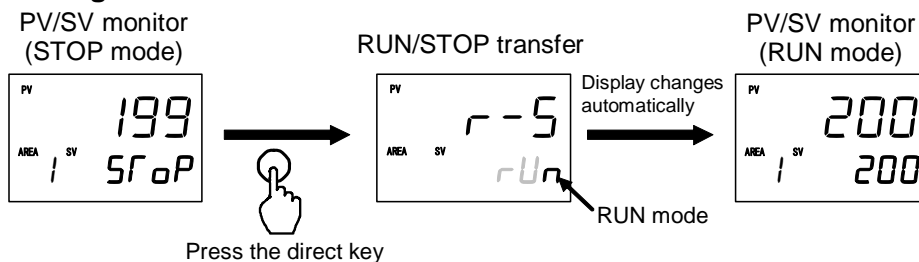



## ■ RUN/STOP transfer by Digital input (DI) [optional]

RUN/STOP transfer by the Digital input (DI) is possible with the Digital input (DI) assignment of the Engineering mode.

 For the Digital input (DI) assignment, refer to **7.5 Engineering Mode (P. 7-80)**.

### ● Terminal Configuration

The Digital input (DI) positions to which RUN/STOP transfer can be assigned vary depending on the optional function type. The RUN/STOP transfer positions for each optional function are indicated below.

Optional function A (DI1 to DI5)

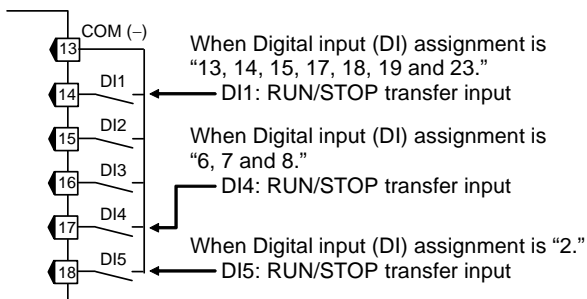

Optional function B, C, D (DI1, DI2)

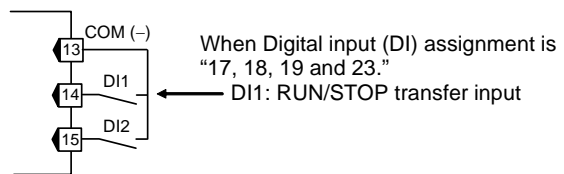

Optional function E (DI1 to DI3)

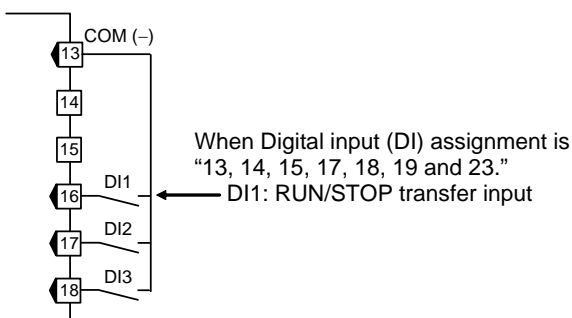

Optional function F and J (DI1)

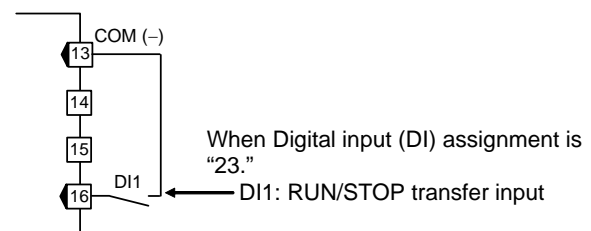

Optional function 3, 4, 5, 6, 7, 8 (DI1)

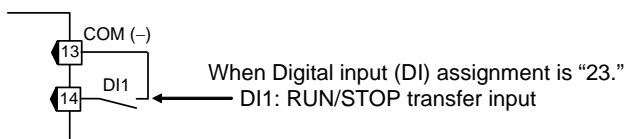

Contact closed: RUN
Contact open: STOP



Contact input from external devices or equipment should be dry contact input. If it is not dry contact input, the input should have meet the specifications below.

Contact specifications: At OFF (contact open) 500 k $\Omega$  or more

At ON (contact closed) 10  $\Omega$  or less

● **Transfer timing of RUN/STOP**

When the contact is closed, RUN. When the contact is open, STOP.

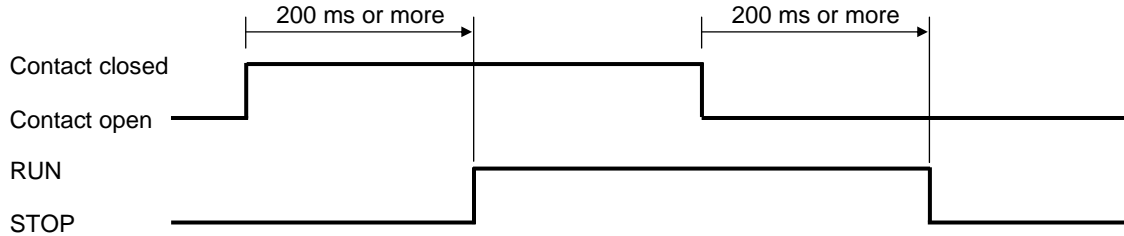

After the contact is transferred, it takes “200 ms + 1 sampling cycle\*” until the action of this instrument is actually selected.

\* Sampling cycle: The value selected by the sampling cycle of the Engineering mode. (Factory set value: 100 ms)

● **RUN/STOP transfer state**

The table below shows the actual RUN/STOP modes and displays under different combinations of settings by Key operation, Communication, and Digital input (DI).

RUN/STOP mode from key operation or communication	RUN/STOP mode by digital input (DI)	Actual RUN/STOP mode state	State of STOP character display
RUN	Contact closed (RUN)	RUN	STOP is not displayed
	Contact open (STOP)	STOP	dsrP
STOP	Contact closed (RUN)		rsrP
	Contact open (STOP)	sr oP	

● **STOP character display**

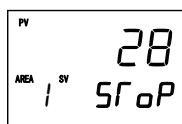

← Display when STOP mode is changed by key operation [When there is no RUN/STOP transfer by the digital input (DI)]



← Display when STOP mode is changed by key operation [When there is RUN/STOP transfer by the digital input (DI)]

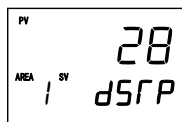

← Display when STOP mode is selected by the digital input (DI)



The display unit to display the STOP character can be changed from the SV display section to the PV display section by referring to “STOP display” in the Engineering mode.

## 6.5 Autotuning (AT)

The Autotuning (AT) function automatically measures, computes and sets the optimum PID values. The Autotuning (AT) can be used for PID control (Direct/Reverse action), Heat/Cool PID control, and Position proportioning PID control (Direct/Reverse action).

### ■ Caution for using the Autotuning (AT)

- When a temperature change (UP and/or Down) is 1 °C or less per minute during Autotuning (AT), Autotuning (AT) may not be finished normally. In that case, adjust the PID values manually. Manual setting of PID values may also be necessary if the set value is around the ambient temperature or is close to the maximum temperature achieved by the load.
- If the output change rate limiter is set, the optimum PID values may not be computed by Autotuning (AT).

### ■ Requirements for Autotuning (AT) start

Start the Autotuning (AT) when all following conditions are satisfied:

To start Autotuning (AT), go to PID/AT transfer in Operation mode.

Operation mode state	RUN/STOP transfer	RUN
	PID/AT transfer	PID control
	Auto/Manual transfer	Auto mode
	Remote/Local transfer	Local mode
Parameter setting	Output limiter high $\geq 0.1\%$ , Output limiter low $\leq 99.9\%$	
Input value state	The Measured value (PV) is not underscale or over-scale.	
	Input error determination point (high) $\geq$ Measured value (PV) $\geq$ Input error determination point (low)	

### ■ Requirements for Autotuning (AT) cancellation

If the Autotuning (AT) is canceled according to any of the following conditions, the controller immediately changes to PID control. The PID values will be the same as before Autotuning (AT) was activated.

When the operation mode is transferred	When the RUN/STOP mode is changed to the STOP mode.
	When the PID/AT transfer is changed to the PID control.
	When the Auto/Manual mode is changed to the manual mode.
	When the Remote/Local mode is changed to the remote mode.
When the parameter is changed	When the temperature Set value (SV) is changed.
	When the PV bias, the PV digital filter, or the PV ratio is changed.
	When the control area is changed.
When the input value becomes abnormal	When the Measured value (PV) goes to underscale or over-scale.
	When the Measured value (PV) goes to input error range. (Measured value (PV) $\geq$ Input error determination point (high) or Input error determination point (low) $\geq$ Measured value (PV))
When the AT exceeded the execution time	When the AT does not end in two hours after AT started
Power failure	When the power failure of more than 20 ms occurs.
Instrument error	When the instrument is in the FAIL state.

### ■ Autotuning (AT) start/stop operation

The Autotuning function can start from any state after power on, during a rise in temperature or in stable control.

1. Press and hold the Shift key for 2 seconds at PV/SV monitor screen until Operation mode is displayed. PID/AT transfer screen is displayed first.

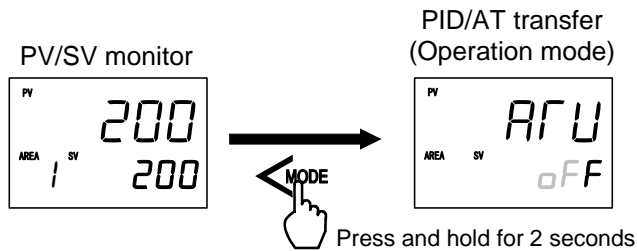

2. If set to “on” by pressing the UP key, the Autotuning (AT) function starts. At this time, the AT lamp flashes.

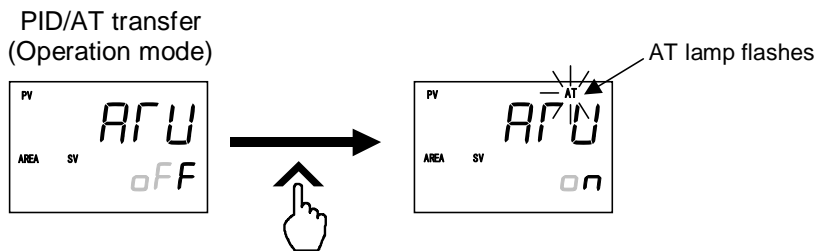

3. When the Autotuning (AT) is finished, the control will automatically returns to PID control. At this time, the AT lamp turns off.

- When canceling the Autotuning (AT) function, press the DOWN key to be set to “oFF.”

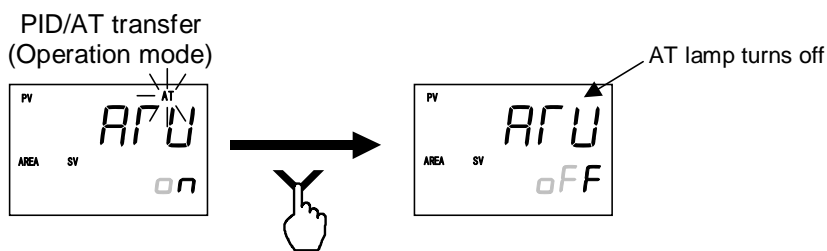

---

### ● Parameters for Autotuning (AT)

Parameters for Autotuning (AT) are provided to compute the PID values suitable for various controlled systems and control actions. Set them, as required. Set the parameters for Autotuning (AT) in the Engineering mode.

Example 1: When you want to find each constant suited for P control, PI control, or PD control by Autotuning.

For P control:

Set “0” to integral time limiter (high) [heat-side] and derivative time limiter (high) [heat-side].

For PI control:

Set “0” to derivative time limiter (high) [heat-side].

For PD control:

Set “0” to integral time limiter (high) [heat-side].

When Autotuning (AT) is executed by making the settings above, the control constants suited for P, PI, or PD control are found.



Also corresponds to Heat/Cool PID control cool-side and Position proportioning PID control.

Example 2: When you want to limit on/off output only at Autotuning (AT)

Autotuning (AT) that limits the ON/OFF output values only at Autotuning (AT) can be executed by setting the output value with AT turned on and the output value with AT turned off.



Only when the Feedback resistance (FBR) input is connected in the Position proportioning PID control, the “Output value with AT turned on” and “Output value with AT turned off” setting becomes valid.



As the other parameters for Autotuning (AT) function, there are AT bias, AT cycle, or AT differential gap time. For the each parameter, refer to **7.5 Engineering Mode (P. 7-140 to P. 7-142)**.

## 6.6 Startup Tuning (ST)

Startup tuning (ST) is a function which automatically computes and sets the PID values from the response characteristics of the controlled system at power ON, transfer from STOP to RUN, and Set value (SV) change.

- As simple autotuning, the PID values can be found in a short time without disturbing controllability for controlled systems with slow response at power ON.
- For controlled systems which require different PID values for each temperature setting, the PID values can be found for each Set value (SV) change.

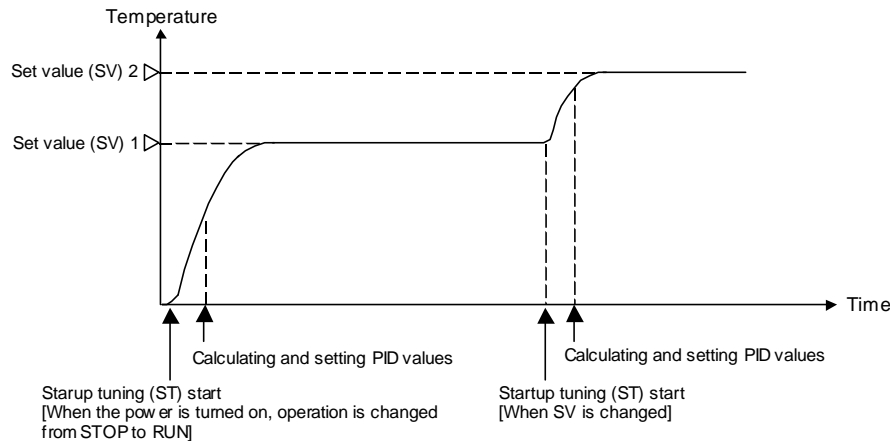

- The setting items related to Startup tuning (ST) are shown below. Set them according to the application used.

Setting item	Details		Setting mode
Start condition	0 (Factory set value)	When the power is turned on, operation is changed from STOP to RUN, or the Set value (SV) is changed.	Engineering mode
	1	When the power is turned on or operation is changed from STOP to RUN.	
	2	When the Set value (SV) is changed.	
Execution method	on1	Execute once	Operation mode
	on2	Execute always	
	oFF (Factory set value)	ST unused	



**Startup tuning (ST) function does not correspond to the Heat/Cool PID control (only in the temperature fall direction) and the Position proportioning PID control.**



If the Startup tuning (ST) function is executed just when the power is turned on or selection is made from STOP to RUN as one of the ST startup conditions, control starts at Hot start 2 even if set to Hot start 1 (factory set value).



Refer to ■ **Hot/Cold start selection (P. 6-42)**.

### ■ Caution for using the Startup tuning (ST)

- For Startup tuning (ST) at power ON or transfer from STOP to RUN, always set the heater power to ON simultaneously with the start of tuning or before the start of tuning.
- Start Startup tuning (ST) in the state in which the temperature differential of the Measured value (PV) and Set value (SV) at the start of Startup tuning (ST) is twice the proportional band, or greater.
- If in Heat/Cool PID control, start activating the Startup tuning (ST) function under the condition of “Set value (SV) > Measured value (PV).” Only the PID values on the heat-side are automatically computed but no PID values on the cool-side are changed. Execute the Autotuning (AT) function to the PID valued on the cool-side.

- When the manipulated output may be limited by the Output limiter setting, the optimum PID values may not be computed by Startup tuning (ST).
- When setting the Output change rate limiter, the optimum PID values may not be computed by Startup tuning (ST).
- When setting the Setting change rate limiter, the optimum PID values are not obtained even when Startup tuning (ST) is executed at Set value (SV) change.

### ■ Requirements for Startup tuning (ST) start

Start the Startup tuning (ST) when all following conditions are satisfied:

Operation mode state	RUN/STOP transfer	RUN
	PID/AT transfer	PID control
	Auto/Manual transfer	Auto mode
	Remote/Local transfer	Local mode
Parameter setting	Startup tuning (ST) is set to ON. (Execute once, Execute always)	
	Output limiter high $\geq 0.1$ %, Output limiter low $\leq 99.9$ %	
Input value state	The Measured value (PV) is not underscale or over-scale.	
	Input error determination point (high) $\geq$ Measured value (PV) $\geq$ Input error determination point (low)	
	At Startup tuning (ST) at Set value (SV) change, the Measured value (PV) shall be stabilized.	
	Set value (SV) $>$ Measured value (PV) (Heat/Cool PID control)	
Output value state	At startup, output is changed and saturated at the Output limiter high or the Output limiter low.	

### ■ Requirements for Startup tuning (ST) cancellation

If the Startup tuning (ST) is canceled according to any of the following conditions, the controller immediately changes to PID control. The PID values will be the same as before ST was activated.

When the parameter is changed	When Startup tuning (ST) is set to OFF
	When the PV bias, the PV digital filter, or the PV ratio is changed.
When the operation mode is transferred	When the RUN/STOP mode is changed to the STOP mode.
	When the Autotuning (AT) is activated.
	When the Auto/Manual mode is changed to the Manual mode.
	When the Remote/Local mode is changed to the Remote mode.
When the input value becomes abnormal	When the Measured value (PV) goes to underscale or over-scale.
	When the Measured value (PV) goes to input error range. (Measured value (PV) $\geq$ Input error determination point (high) or Input error determination point (low) $\geq$ Measured value (PV))
When the ST exceeded the execution time	When the ST does not end in hundred minutes after ST started
Power failure	When the power failure of more than 20 ms occurs.
Instrument error	When the instrument is in the FAIL state.

### ■ Startup tuning (ST) setting

The setting procedure when executing Startup tuning (ST) only one time at power ON is shown below as a setting example.

#### Step 1: Set the start condition

First, set “When the power is turn on” to Startup tuning (ST) start condition by Engineering mode.

1. Change the Operation mode from RUN mode to STOP mode.

 To change from RUN mode to STOP mode, refer to **6.4 RUN/STOP Transfer (P. 6-11)**.

2. Press the Shift key while pressing the SET key for 2 seconds at PV/SV monitor screen until Engineering mode is displayed. Function block 10 screen is displayed first.

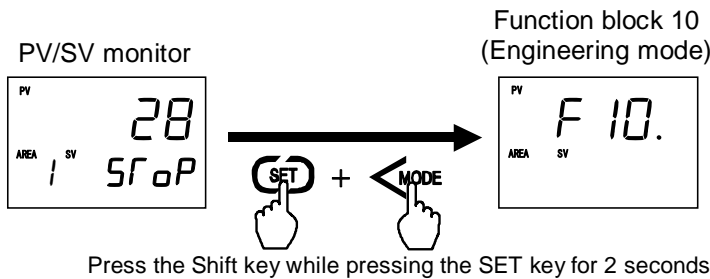

3. Press the DOWN key six times until Function block 54 screen is displayed.

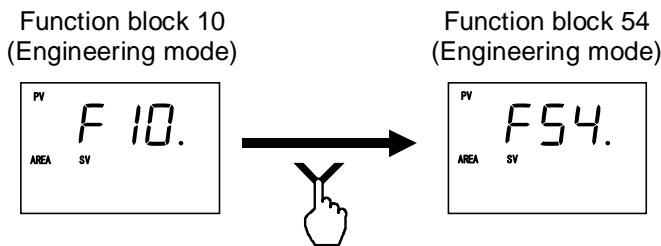

4. Press the SET key until ST start condition screen will be displayed.

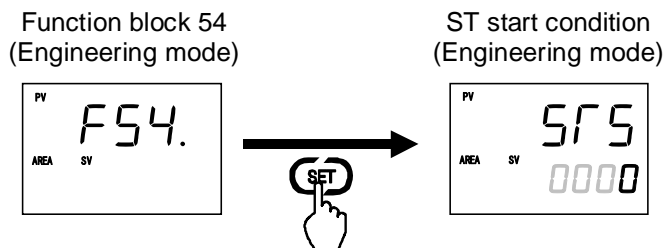

5. Press the UP key to change the number to 1.

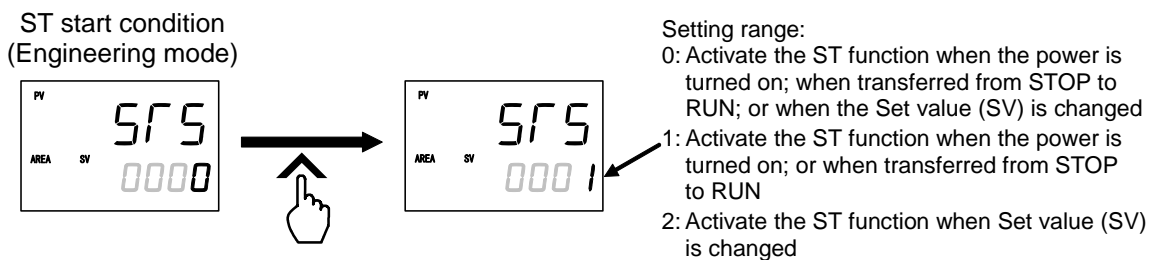



6. Press the SET key to store the new value. The screen goes to the ST proportional band adjusting factor screen.

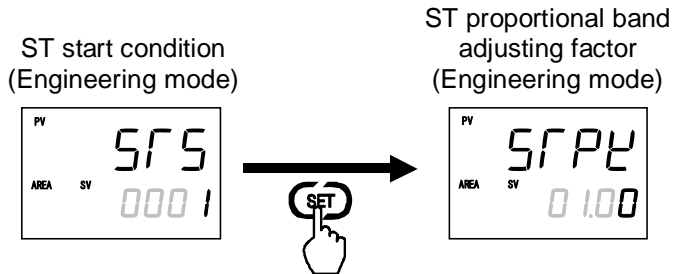

7. To return the PV/SV monitor, press the Shift key while pressing the SET key.

## Step 2: Set the execution method

Set that the Startup tuning (ST) will be executed only once.

1. Change the Operation mode from STOP mode to RUN mode by RUN/STOP transfer screen of operation mode.

 To change from STOP mode to RUN mode, refer to **6.4 RUN/STOP Transfer (P. 6-11)**.

2. Press the Shift key twice at RUN/STOP transfer screen until Startup tuning (ST) screen is displayed.

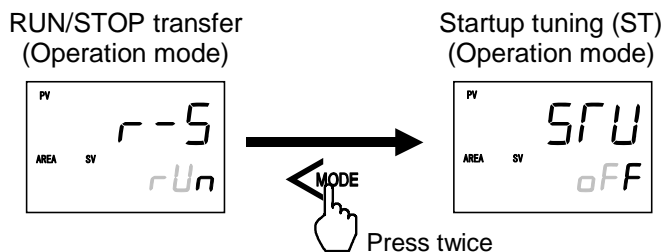

3. Press the UP key to set “on1 (Execute once).”

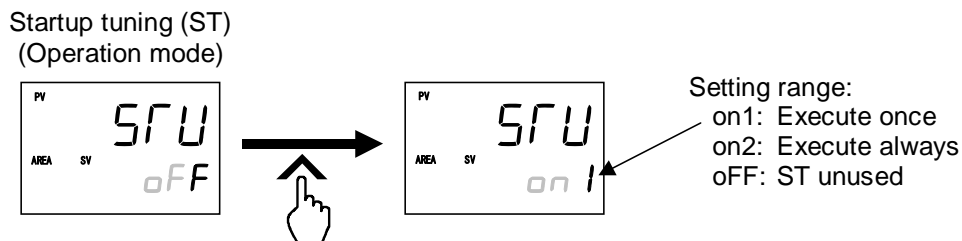

4. Thus, the Startup tuning (ST) setting has been finished. To return the PV/SV monitor, press and hold the Shift key to 2 seconds.

**Step 3: Start the Startup tuning (ST)**

Turn off the power once and turn it on again. The Startup tuning (ST) will automatically start. When the calculation and setting of PID values is completed, setting of the Startup tuning (ST) screen will automatically change to “oFF.”

Startup tuning (ST)  
(Operation mode)



If the setting is set to “Execute once”:  
When the Startup tuning (ST) is finished, the setting will automatically return to “oFF.”



When Startup tuning (ST) was interrupted, the setting does not change to “oFF.”  
Startup tuning (ST) starts when the restart conditions are satisfied.



As the parameters for Startup tuning (ST) function, there are ST proportional band adjusting factor, ST integral time adjusting factor, and ST derivative time adjusting factor in Engineering mode.

However, use the same setting as the factory set values (1.00 times).

Example: When set the proportional band adjusting factor

Proportional band (P) =

Computed proportional band × Proportional band adjusting factor (0.01 to 10.00 times)

## 6.7 Auto/Manual Transfer

The Auto/Manual transfer can be made by Digital input (DI) or Communication (optional) other than the key operation.

 **When the digital input Auto/Manual transfer function is used, it is impossible to transfer Auto/Manual through key operation if the contact is not closed. (When contact opens: Manual mode is maintained.)**

 For details of Auto/Manual transfer by Communication, refer to the separate **FB100/FB400/FB900 Communication Instruction Manual (IMR01W04-E□)**.

 The Manipulated output value when changed to the Manual mode from the Auto mode differs depending on the MV transfer function (MVTs) setting. The MV transfer function (MVTs) enables the selection of whether a balanceless and bumpless transfer is made or a previous manipulated output value is used.

 For the MV transfer function (MVTs), refer to **7.5 Engineering Mode (P. 7-124)**.

### ● Balanceless-bumpless function

This function is used to prevent overload caused by the Manipulated output value (MV) suddenly changing when Auto mode is transferred to Manual mode and vice versa.

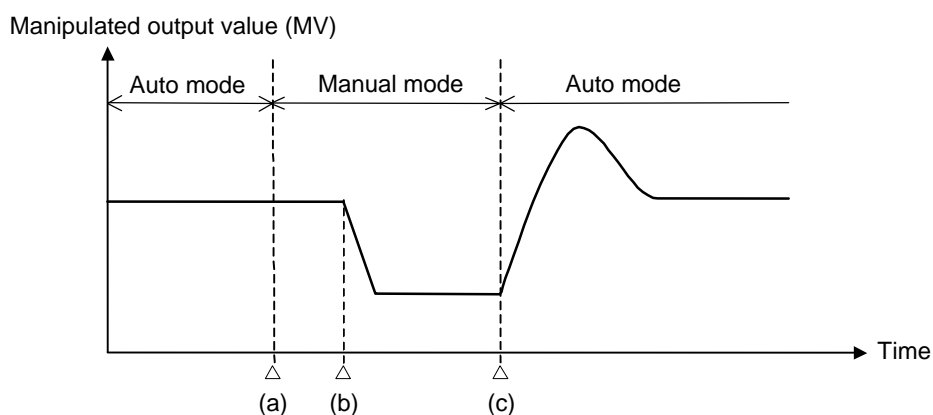

(a) Transfer from Auto mode to Manual mode.

However, when the mode is transferred to Manual mode, the Manipulated output value used in Auto mode will be used as the manual output value in Manual mode.

(b) The Manipulated output value is changed (Manual mode function)

(c) Transfer from Manual mode to Auto mode.

When the mode is transferred to Auto mode, the controller starts PID control based on the MV used in Manual mode.

■ Auto/Manual transfer by Front key operation

1. Press and hold the Shift key for 2 seconds at PV/SV monitor screen until Operation mode is displayed.

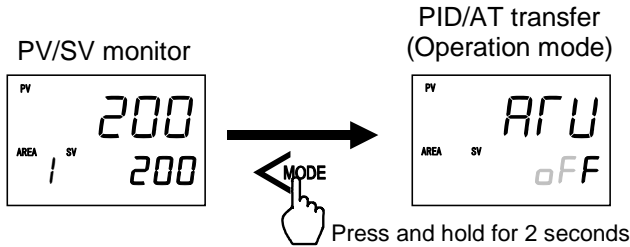

2. Press the Shift key several times until Auto/Manual transfer screen is displayed.

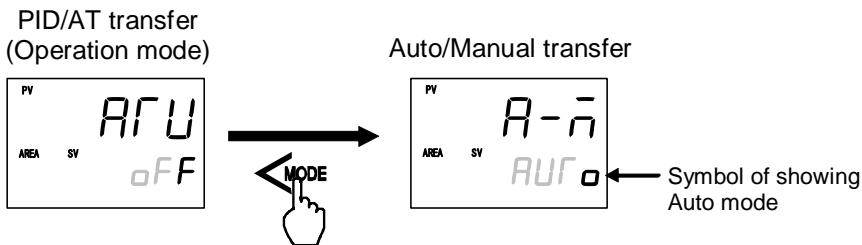

3. Press the UP key to change to the Manual mode from the Auto mode. The Manual (MAN) mode lamp lights.

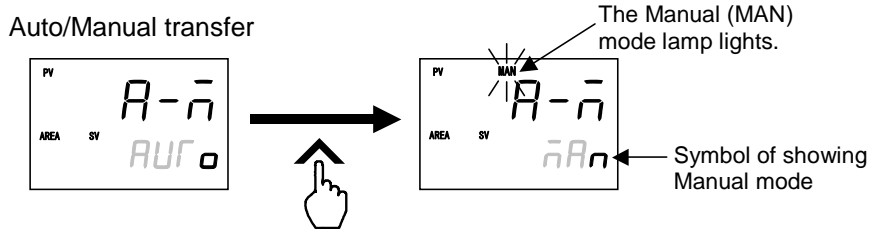

- To change from the Manual mode to the Auto mode, press the DOWN key.

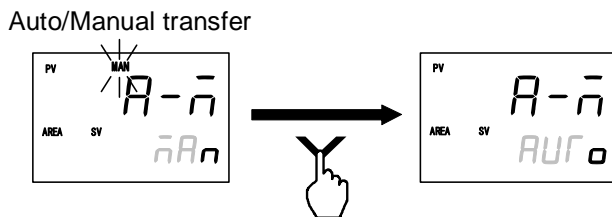

4. Press and hold the Shift key for 2 seconds to change to the PV/SV monitor from the Operation mode.

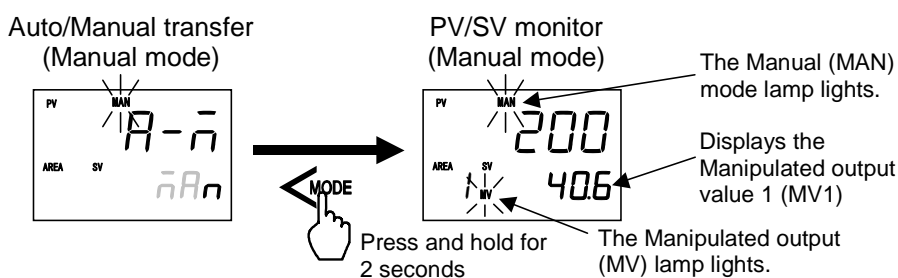

When in STOP mode, no Manual (MAN) mode lamp turns on.

### ■ Auto/Manual transfer by Direct key operation

To execute Auto/Manual transfer by Direct key, set Auto/Manual transfer by Direct key type in Engineering mode.

Every time the Direct key is pressed, the Auto mode is changed to the Manual mode alternately.

 For the Direct key type selection, refer to **7.5 Engineering Mode (P. 7-70)**.

#### ● To change from Auto mode to Manual mode

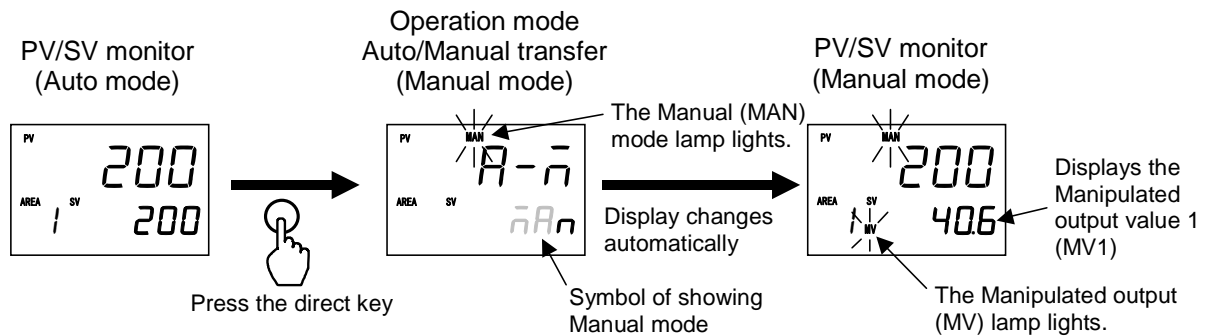

#### ● To change from Manual mode to Auto mode

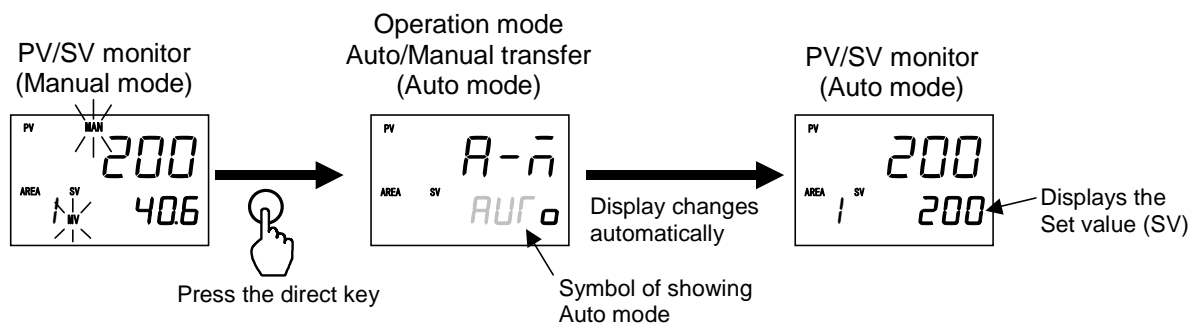

■ **Auto/Manual transfer by Digital input (DI) [optional]**

Auto/Manual transfer by the Digital input (DI) is possible with the Digital input (DI) assignment of the Engineering mode.

🗨 For the Digital input (DI) assignment, refer to **7.5 Engineering Mode (P. 7-80)**.

● **Terminal configuration**

The Digital input (DI) positions to which Auto/Manual transfer can be assigned vary depending on the optional function type. The Auto/Manual transfer positions for each optional function are indicated below.

Optional function A (DI1 to DI5)

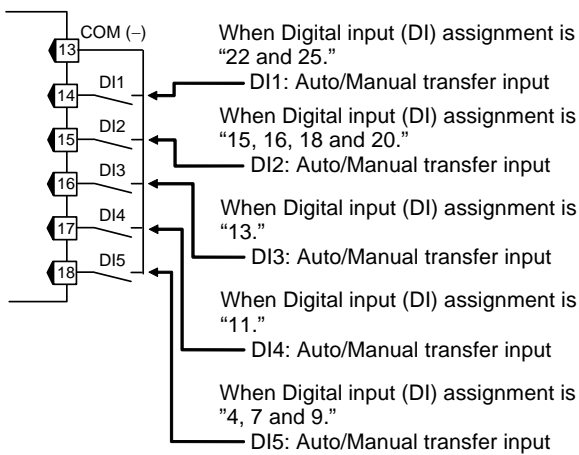

Optional function B, C, D (DI1, DI2)

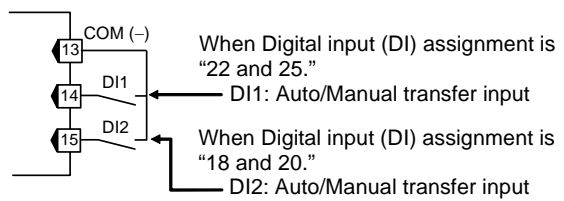

Optional function E (DI1 to DI3)

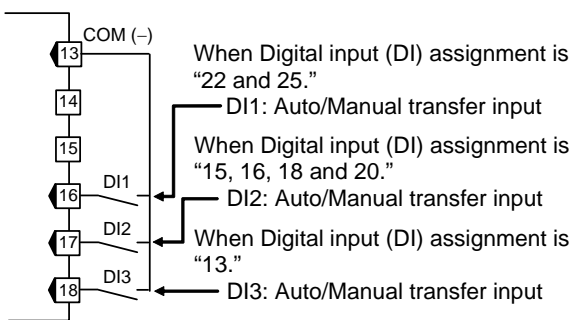

Optional function F and J (DI1)

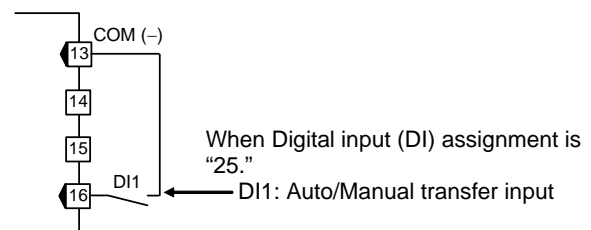

Optional function 3, 4, 5, 6, 7, 8 (DI1)

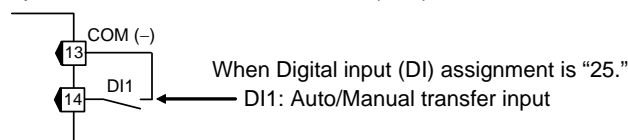

Contact closed: Auto mode  
Contact open: Manual mode



Contact input from external devices or equipment should be dry contact input. If it is not dry contact input, the input should have meet the specifications below.

Contact specifications: At OFF (contact open) 500 kΩ or more

At ON (contact closed) 10 Ω or less

### ● Transfer timing of Auto/Manual

When the contact is closed, the mode changes to Auto. When the contact is open, the mode changes to Manual.

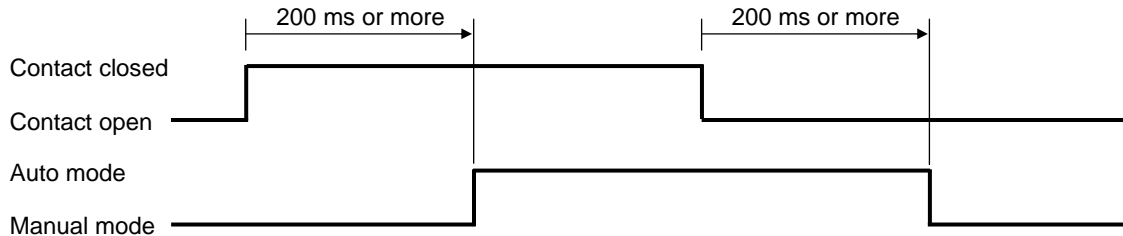

**After the contact is transferred, it takes “200 ms + 1 sampling cycle\*” until the action of this instrument is actually selected.**

\* Sampling cycle: The value selected by the sampling cycle of the Engineering mode. (Factory set value: 100 ms)

### ● Auto/Manual transfer state

The table below shows the actual Auto/Manual modes and displays under different combinations of settings by Key operation, Communication, and Digital input (DI).

Auto/Manual mode from Key operation or communication	Auto/Manual mode by Digital input (DI)	Actual Auto/Manual mode state	Display lamp state
Auto mode	Contact closed (Auto mode)	Auto mode	MAN mode lamp OFF
	Contact open (Manual mode)	Manual mode	MAN mode lamp ON
Manual mode	Contact closed (Auto mode)		
	Contact open (Manual mode)		

### ■ Procedure for setting the Manipulated output value (MV) in Manual mode

When the controller is in Manual mode, the Manipulated output value (MV) can be manually set.

#### Setting procedures:

1. Make sure the Manual (MAN) mode lamp and the Manipulated output (MV) are lit.

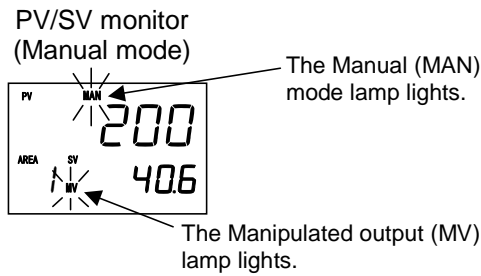

2. Set the Manipulated output value (MV) by UP or DOWN keys.

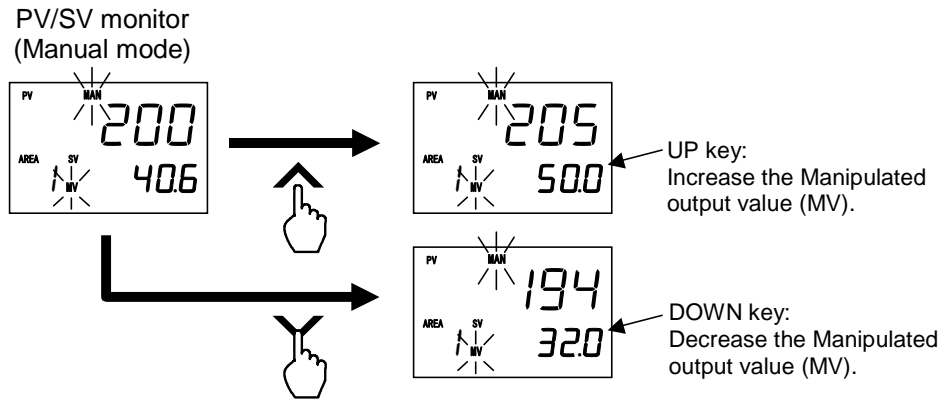

Keeping pressing the DOWN or UP key makes numeric value change faster.



For Position proportioning PID control:

- When there is a Feedback resistance (FBR) input, the valve position can be set by UP or DOWN key.

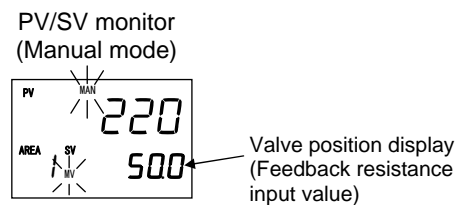

- When there is no Feedback resistance (FBR) input, the output becomes ON while the UP key [open-side output (OUT1)] or DOWN key [close-side output (OUT2)] is pressed and the output becomes OFF when your finger is removed from the key. MV is hidden.

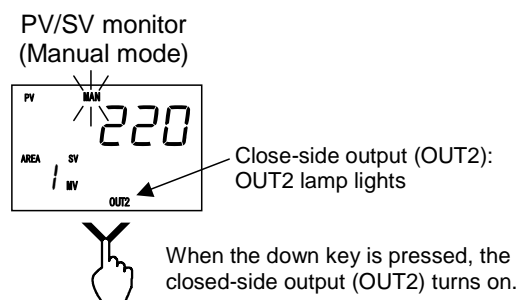
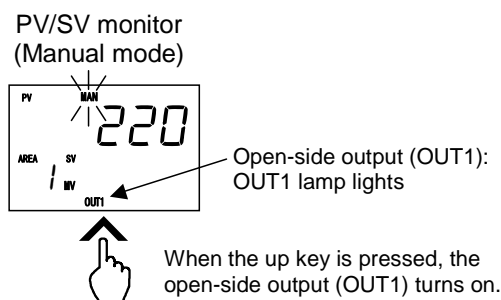



## 6.8 Remote/Local Transfer

The Remote/Local transfer can be made by Digital input (DI) or Communication (optional) other than the key operation.

 When the digital input Remote/Local transfer function is used, it is impossible to transfer Remote/Local through key operation if the contact is not closed. (When contact opens: Local mode is maintained.)

 For details of the Remote/Local transfer by Communication, refer to the separate **FB100/FB400/FB900 Communication Instruction Manual (IMR01W04-E□)**.

### ■ Remote/Local transfer by Front key operation

1. Press and hold the Shift key for 2 seconds at PV/SV monitor screen until Operation mode is displayed.

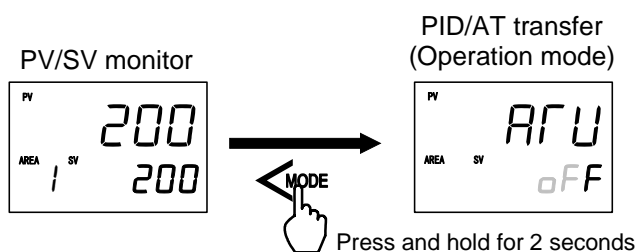

2. Press the Shift key several times until Remote/Local transfer screen is displayed.

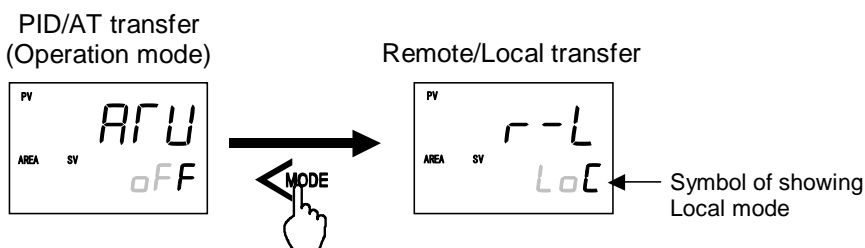

3. Press the UP key to change to the Remote mode from the Local mode.

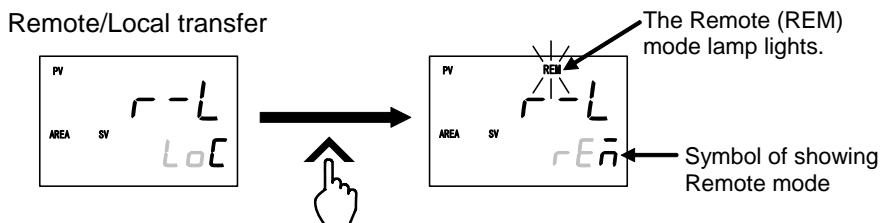

- To change from the Remote mode to the Local mode, press the DOWN key.

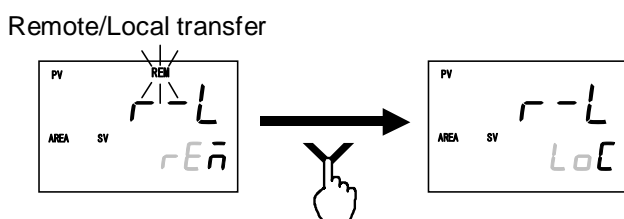

- Press and hold the Shift key for 2 seconds to change to the PV/SV monitor from the Operation mode.

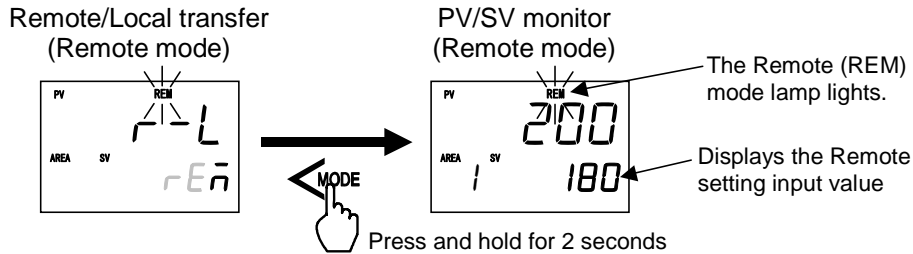

When in STOP mode, no Remote (REM) mode lamp turns on.

### ■ Remote/Local transfer by Direct key operation

Remote/Local transfer by the Direct key is possible with the Direct key type of the Engineering mode. Set “Remote/Local transfer” to the Direct key type. Every time the Direct key is pressed, the Remote mode is changed to the Local mode alternately.

For the Direct key type selection, refer to **7.5 Engineering Mode (P. 7-70)**.

#### ● To change from Local mode to Remote mode

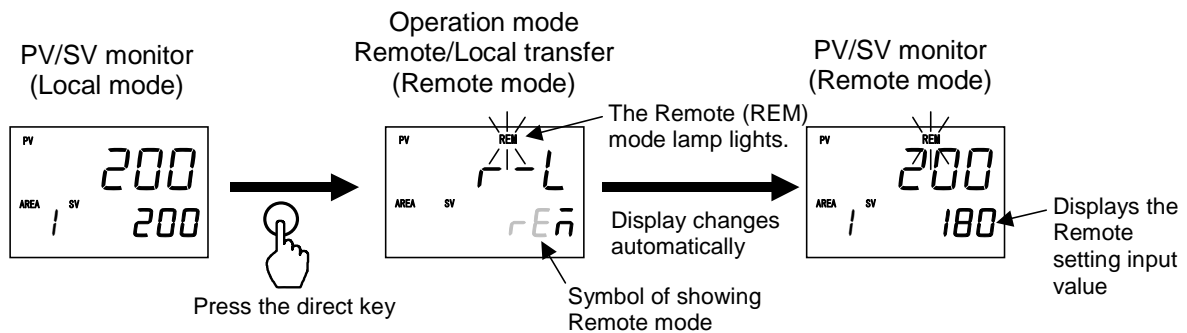

#### ● To change from Remote mode to Local mode

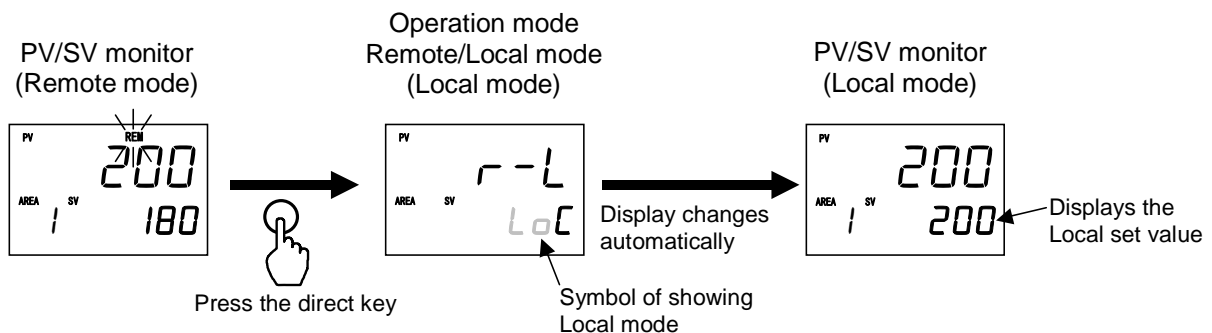

## ■ Remote/Local transfer by Digital input (DI) [optional]

Remote/Local transfer by the Digital input (DI) is possible with the Digital input (DI) assignment of the Engineering mode.

 For the Digital input (DI) assignment, refer to **7.5 Engineering Mode (P. 7-80)**.

### ● Terminal configuration

The Digital input (DI) positions to which Remote/Local transfer can be assigned vary depending on the optional function type. The Remote/Local transfer positions for each optional function are indicated below.

#### Optional function A (DI1 to DI5)

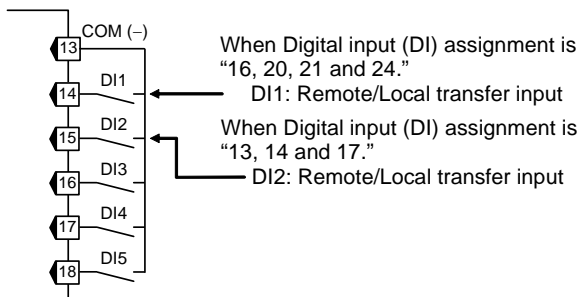

#### Optional function B, C, D (DI1, DI2)

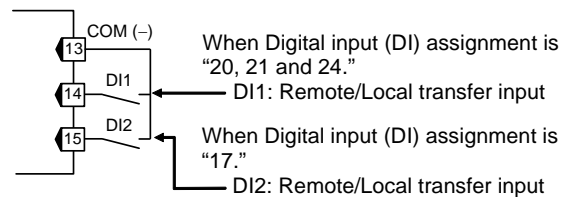

#### Optional function E (DI1 to DI3)

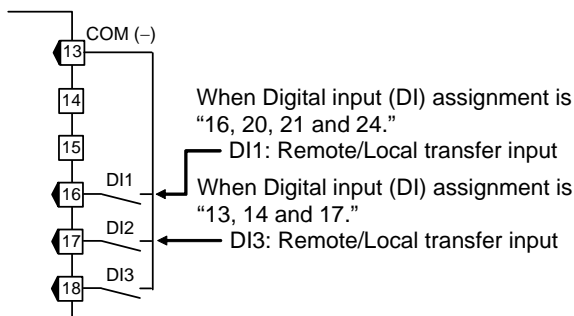

#### Optional function F and J (DI1)

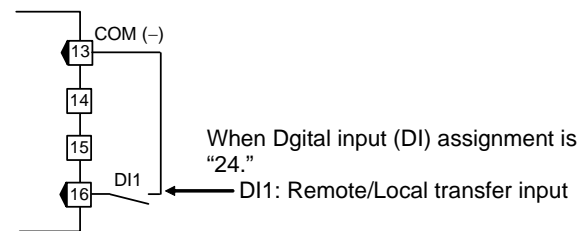

#### Optional function 3, 4, 5, 6, 7, 8 (DI1)

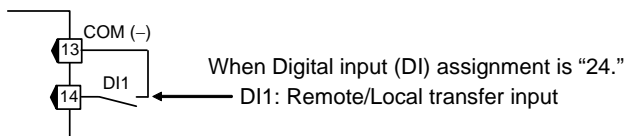

Contact closed: Remote mode  
Contact open: Local mode



Contact input from external devices or equipment should be dry contact input. If it is not dry contact input, the input should have meet the specifications below.

Contact specifications: At OFF (contact open) 500 k $\Omega$  or more  
At ON (contact closed) 10  $\Omega$  or less

● **Transfer timing of Remote/Local**

When the contact is closed, the mode changes to Remote. When the contact is open, the mode changes to Local.

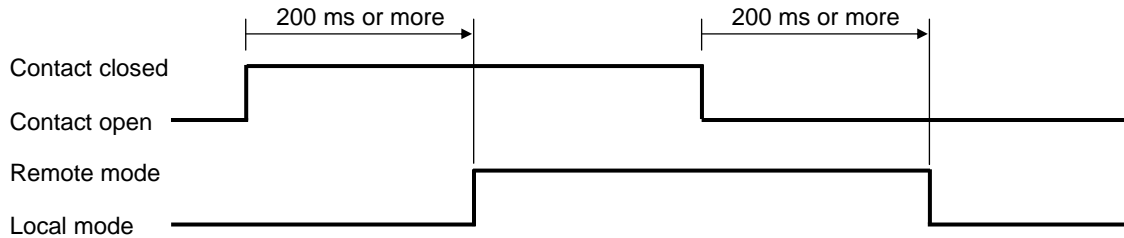

**After the contact is transferred, it takes “200 ms + 1 sampling cycle\*” until the action of this instrument is actually selected.**

\* Sampling cycle: The value selected by the sampling cycle of the Engineering mode. (Factory set value: 100 ms)

● **Remote/Local transfer state**

The table below shows the actual Remote/Local modes and displays under different combinations of settings by Key operation, Communication, and Digital input (DI).

Remote/Local mode from Key operation or communication	Remote/Local mode by Digital input (DI)	Actual Remote/Local mode state	Display lamp state
Remote mode	Contact closed (Remote mode)	Remote mode (Cascade control or Ratio setting)	REM mode lamp ON
	Contact open (Local mode)	Local mode	REM mode lamp OFF
Local mode	Contact closed (Remote mode)		
	Contact open (Local mode)		

## 6.9 Control Area Transfer

The control area transfer can be made by Digital input (optional), Communication (optional) or Area soak time other than the key operation.

- For details of the Control area transfer by Communication, refer to the separate **FB100/FB400/FB900 Communication Instruction Manual (IMR01W04-E□)**.

### ● Memory area function

Multi memory area function can store up to 8 individual sets of SVs and parameters in parameter setting mode. One of the areas is used for control, and the currently selected area is Control area.

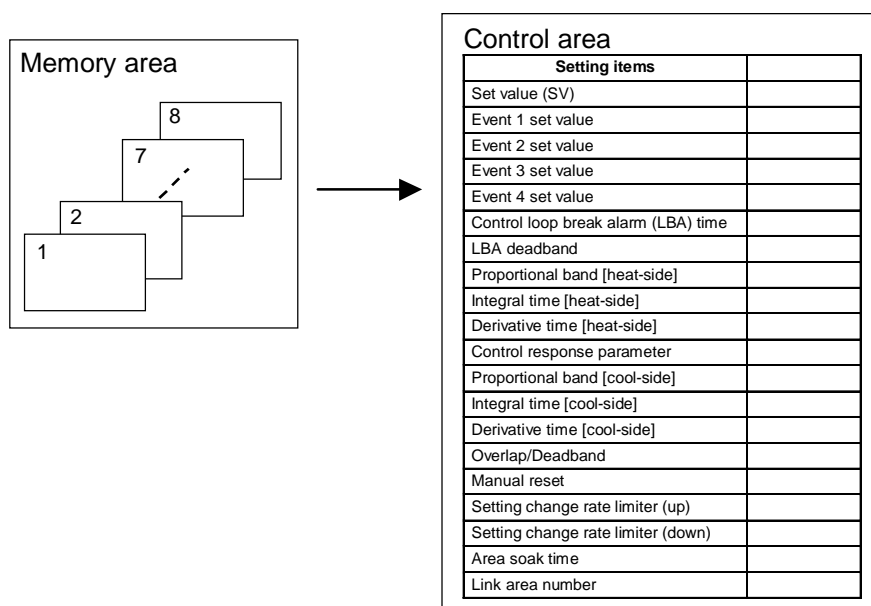

- The memory area number (Control area) can be changed at either RUN or STOP.
- The memory area number stored at last is taken as Control area.
- Ramp/Soak control is possible by using Area soak time, Link area number and Setting change rate limiter (up/down) in Parameter setting mode.  
For details, refer to **6.13 Ramp/Soak Control (P. 6-52)**.

■ **Control area transfer by Front key operation**

1. Press the SET key several times at PV/SV monitor screen until Memory area transfer screen is displayed.

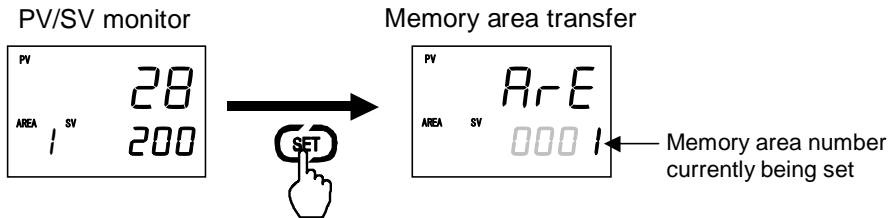

2. Select the memory area number which needs to be changed by pressing the UP or DOWN key.

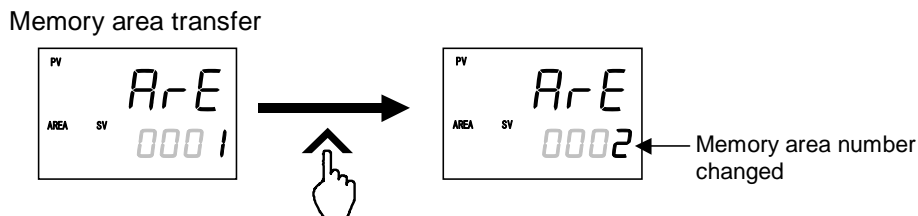

3. Press the SET key to store the new memory area number. The screen goes to the next parameter.

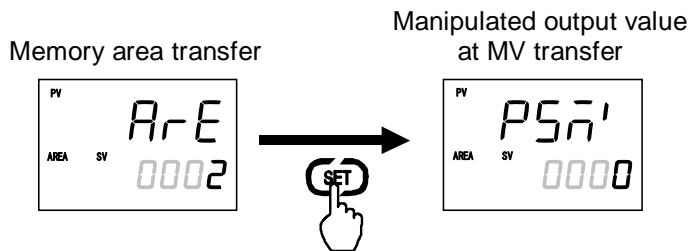

4. Press the SET key several times to return to the PV/SV monitor.

 After a new value is displayed on the display by using UP and DOWN keys, if no key operation is performed within 1 minute without pressing SET key, this instrument returns to the PV/SV monitor screen and the memory area number will not be changed.

 If the display below appears when the set key is pressed to change to the Memory area transfer screen, memory area transfer is not possible using the front keys. If you wish to change the memory area using the front keys, switch to Local mode in “Control area Local (LOC)/External (EXT) transfer” of Operation mode. (For this procedure, refer to page 6-38.)

Memory area transfer

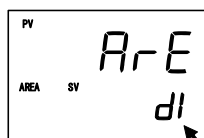

When the following conditions are both satisfied, the display appears as shown at left.

- Memory area transfer without area set (set value: 6 to 12) is selected in “Digital input (DI) assignment” of Engineering mode.
- External mode is selected in “Control area Local/External transfer” of Operation mode.

Parameter indicating that memory area transfer by Digital input (DI) is valid

## ■ Control area transfer by Direct key operation

Memory area transfer by the Direct key is possible with the Direct key type of the Engineering mode. Set “Memory area transfer” to the Direct key type.

 For the Direct key type selection, refer to **7.5 Engineering Mode (P. 7-70)**.

1. Press the Direct key at PV/SV monitor screen until Memory area transfer screen is displayed.

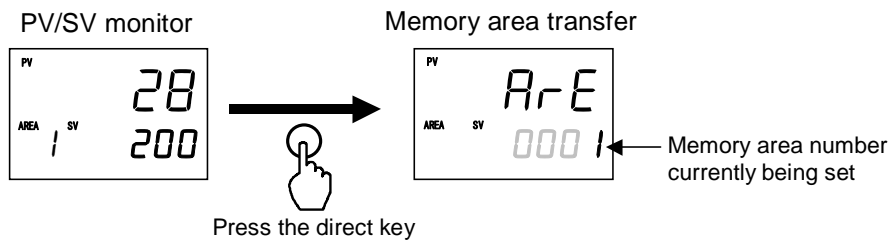

2. Select the memory area number which needs to be changed by pressing the UP or DOWN key.

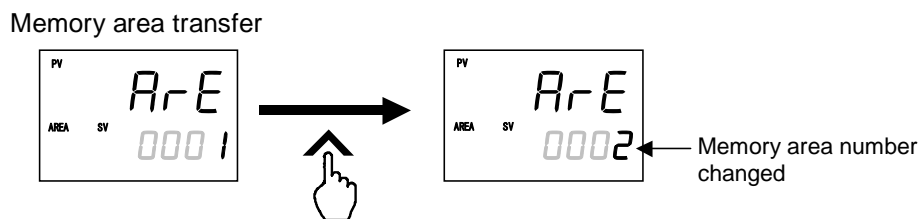

3. Press the SET key to store the new memory area number. The screen return to the PV/SV monitor screen.

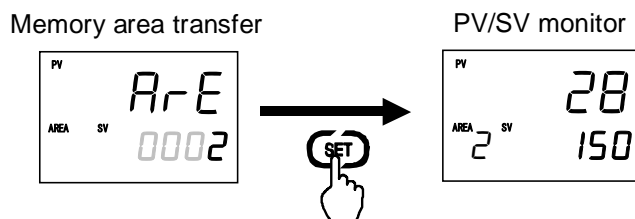

■ **Control area transfer by Digital input (DI) [optional]**

Memory area (Control area) transfer by the Digital input is possible with the Digital input (DI) assignment of the Engineering mode.

📖 For the Digital input (DI) assignment, refer to **7.5 Engineering Mode (P. 7-80)**.

● **Terminal configuration**

The Digital input (DI) positions to which memory area transfer can be assigned vary depending on the optional function type. The memory area transfer positions for each optional function are indicated below.

Optional function A (DI1 to DI5)

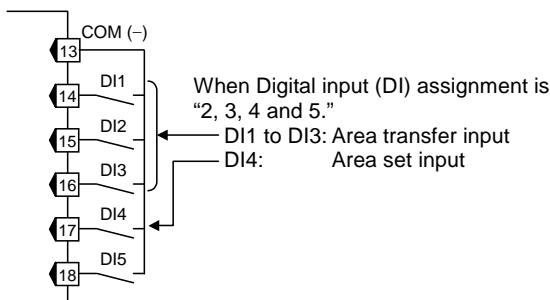

Optional function A (DI1 to DI5)

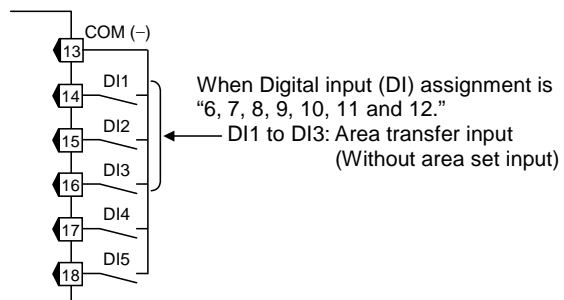

Optional function E (DI1 to DI3)

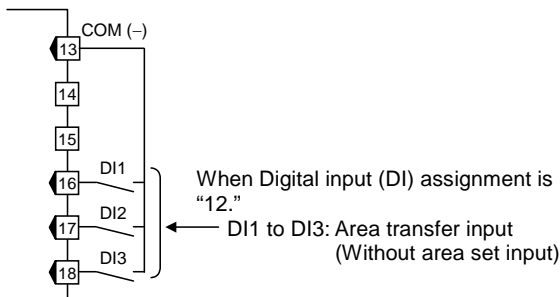

The table below shows the Digital input (DI) status and selected memory numbers for control area transfer.

Digital input	Memory area number							
	1	2	3	4	5	6	7	8
DI1	×	–	×	–	×	–	×	–
DI2	×	×	–	–	×	×	–	–
DI3	×	×	×	×	–	–	–	–

×: Contact open  
 –: Contact closed



Contact input from external devices or equipment should be dry contact input. If it is not dry contact input, the input should have meet the specifications below.

Contact specifications: At OFF (contact open) 500 kΩ or more

At ON (contact closed) 10 Ω or less



### ● Transfer timing of memory area (Control area)

Select the memory area number according to the open or closed state of the contact (DI 1 to DI 3). Then, to store a new memory area number as the Control area, close the DI 4 for Memory area set.

[Example] Change the memory area number to 6

First, close the contacts between DI1 and DI3 and the common terminal. Next, open the contact between DI2 and the common. Then, close the contact between DI4 (area set) and the common from open status (rising edge), the memory area number in the controller will change to “6.”

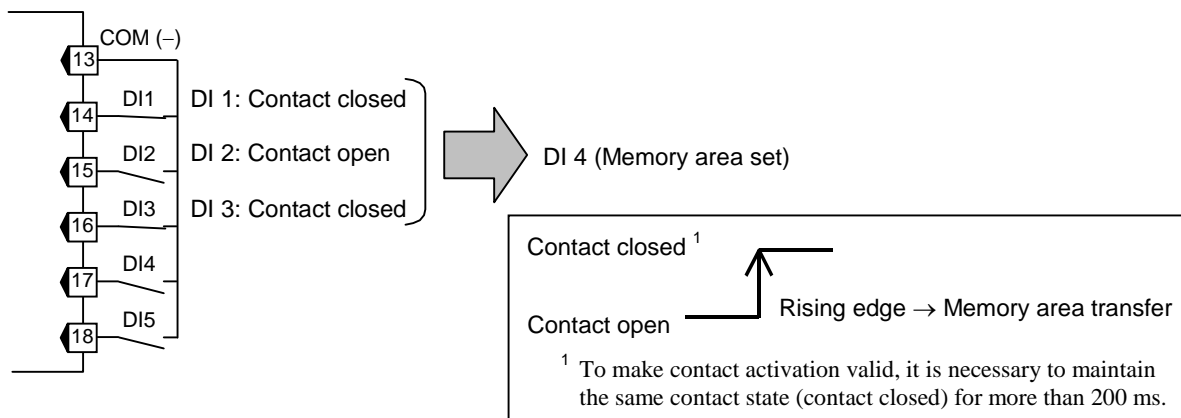

**After the contact is closed, it takes “200 ms + 1 sampling cycle\*” until the action of this instrument is actually selected.**

\* Sampling cycle: The value selected by the sampling cycle of the Engineering mode. (Factory set value: 100 ms)



In the case where there is no area set input, transfer to the set memory area takes place 2 seconds after the memory area number is set by the three contacts (DI1 to DI3).

### ● Control area Local (LOC)/External (EXT) transfer

If memory area transfer without area set input (set value: 6 to 12) is selected in “Digital input (DI) assignment” of Engineering mode, specify whether “Memory area transfer by front key or communication” or “Memory area transfer by Digital input (DI)” is valid.

1. Press and hold the Shift key for 2 seconds at PV/SV monitor screen until operation mode is displayed.

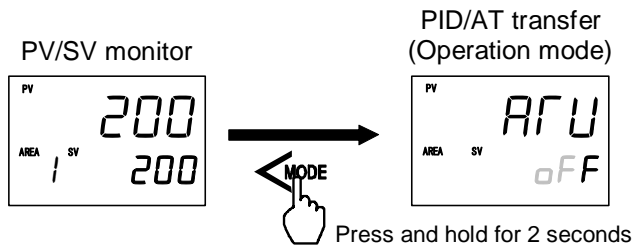

2. Press the Shift key several times until Control area Local (LOC)/External (EXT) transfer screen is displayed.

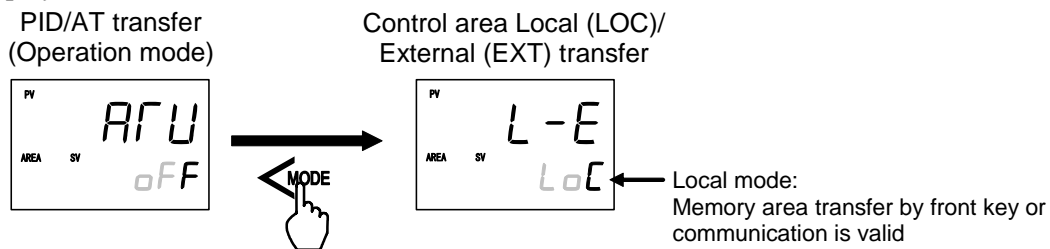

3. Press the UP key to change to the External mode from the Local mode.  
Press the DOWN key to change to the Local mode from the External mode.

Control area Local (LOC)/  
External (EXT) transfer

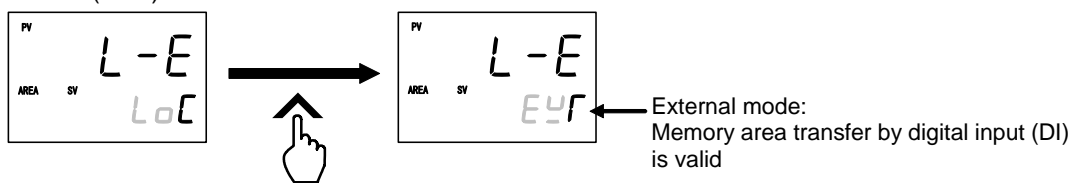

4. Press and hold the Shift key for 2 seconds to change to the PV/SV monitor from the Operation mode.



When “EXT: External mode” is selected at Control area Local (LOC)/External (EXT) transfer, “dl” is shown on the SV display and memory area is not changeable from the front panel in the meantime. (Refer to page 6-34)

### ■ Control area transfer by Area soak time (Ramp/Soak Control)

When the memory area number is transferred by using the Area soak time, it is necessary to set the link area number (Parameter setting mode). For details, refer to **6.13 Ramp/Soak Control (P. 6-52)**.

## 6.10 Interlock Release

The Event interlock action holds the event state even if the measured value is out of the event zone after it enters the event zone once. The Interlock release can be made by Digital input (optional), or Communication (optional) other than the key operation.

 **To validate the Event interlock function, it is necessary to set Event interlock (E/L 1 to 4) to “1: Used” in Engineering mode (P. 7-92, 7-99, 7-103 and 7-108).**

 For the Interlock release by Communication, refer to the separate **FB100/FB400/FB900 Communication Instruction Manual (IMR01W04-E□)**.

- The following example shows how the Event interlock is released.

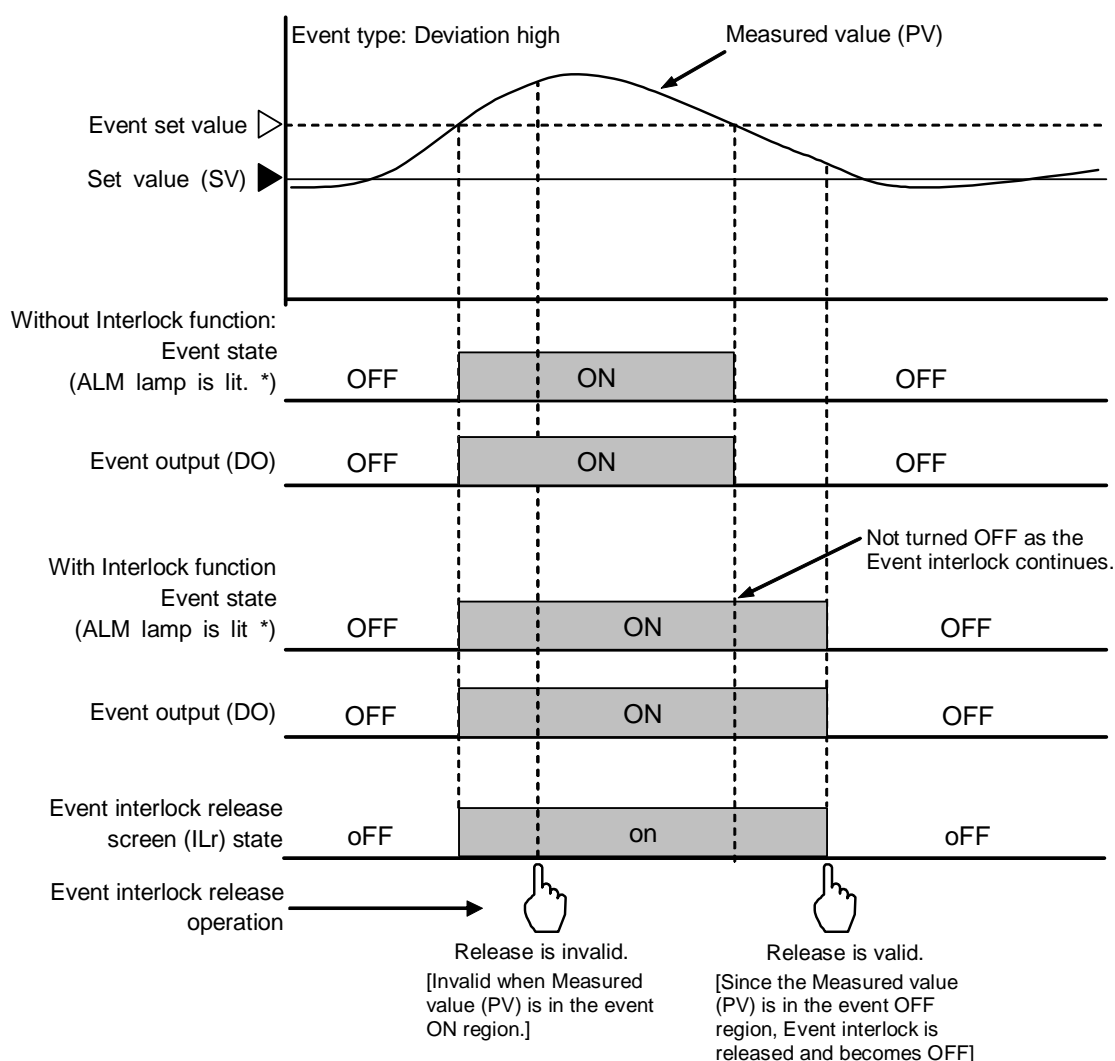

\* Set an alarm lamp lighting conditions to EV1 to EV4 in the Engineering mode. The alarm (ALM) lamp is lit through the OR operation of EV1 to EV4 each of which is set to "1: ALM lamp is lit". (Factory set value: ALM lamp is lit)

■ **Interlock release method by Front key operation**

1. Press the SET key several times at PV/SV monitor screen until Interlock release screen is displayed.

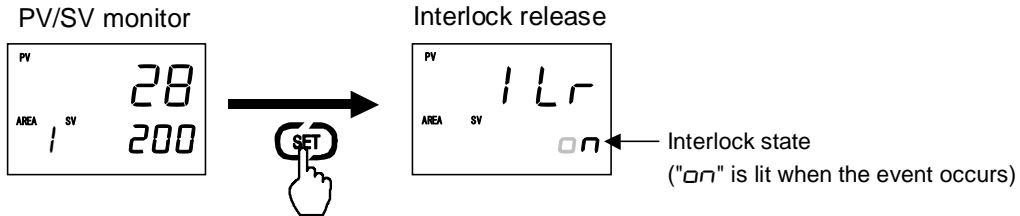

2. Press the DOWN key to release the interlock.

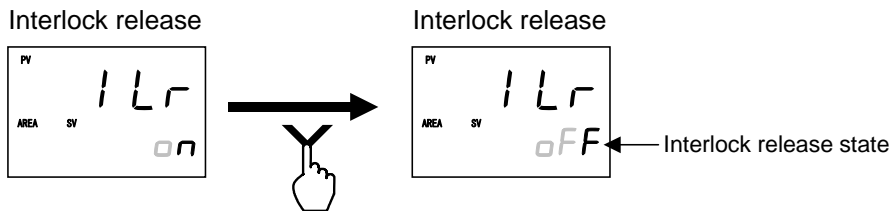

3. Press the SET key to return the PV/SV monitor.

 After a new value is displayed on the display by using UP and DOWN keys, if no key operation is performed within 1 minute without pressing SET key, this instrument returns to the PV/SV monitor screen and the interlock will not be released.

■ **Interlock release method by Digital input (DI) [optional]**

Interlock release by the Digital input (DI) is possible with the Digital input (DI) assignment of the Engineering mode.

 For the Digital input (DI) assignment, refer to **7.5 Engineering Mode (P. 7-80)**.

● **Terminal configuration**

The Digital input (DI) positions to which interlock release can be assigned vary depending on the optional function type. The interlock release positions for each optional function are indicated below.

Optional function A (DI1 to DI5)

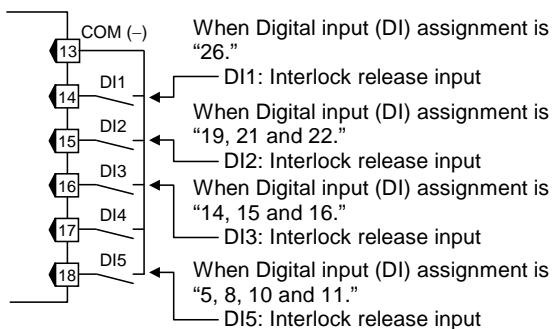

Optional function B, C, D (DI1, DI2)

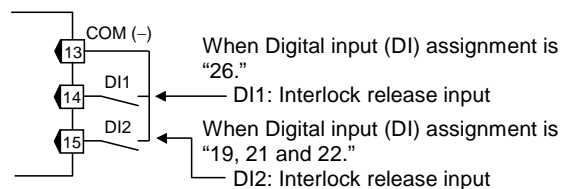

Optional function E (DI1 to DI3)

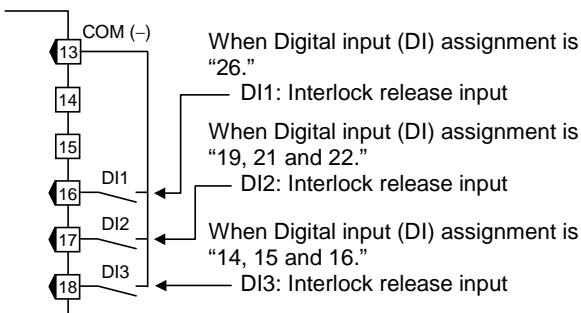

Optional function F and J (DI1)

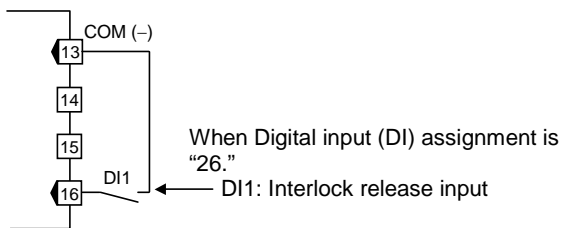

Optional function 3, 4, 5, 6, 7, 8 (DI1)

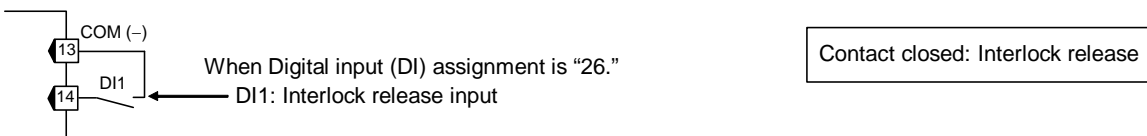

Contact input from external devices or equipment should be dry contact input. If it is not dry contact input, the input should have meet the specifications below.  
 Contact specifications: At OFF (contact open) 500 kΩ or more  
 At ON (contact closed) 10 Ω or less

● Transfer timing of Interlock release

The interlock release operation is taken when DI contact is closed from the open condition (rising edge).

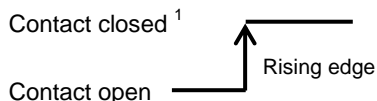

<sup>1</sup> To make contact activation valid, it is necessary to maintain the same contact state (contact closed) for more than 200 ms.



**After the contact is closed, it takes "200 ms + 1 sampling cycle\*" until the action of this instrument is actually selected.**

\* Sampling cycle: The value selected by the sampling cycle of the Engineering mode. (Factory set value: 100 ms)

## 6.11 Start Action at Recovering Power Failure

### ■ Hot/Cold start selection

The operation of this instrument is not affected by a power failure of 20 ms or less. The control start mode at power recovery after more than 20 ms power failure can be selected as follows.

Action when power failure recovers	Operation mode when power failure recovers	Output value when power failure recovers	
Hot start 1	Same as that before power failure	Near the output value before power failure occurs	
Hot start 2	Same as that before power failure	Auto mode	Value as a result of control computation <sup>2</sup>
		Manual mode	Output limiter low <sup>3</sup>
Cold start	Manual mode	Output limiter low <sup>3</sup>	
STOP start	Started in the control stop (STOP) state regardless of the RUN mode before power failure. <sup>1</sup>	Manipulated output value at STOP mode <sup>3</sup>	

Factory set value: Hot start 1

<sup>1</sup> If changed to RUN from STOP by RUN/STOP selection after start, set to the Operation mode before power failure occurs.

<sup>2</sup> The result of control computation varies with the control response parameter.

<sup>3</sup> If there is no Feedback resistance (FBR) input in Position proportioning PID control, the following results.

- Hot start 2 (Manual mode): No output (no control motor is driven)
- Cold start: No output (no control motor is driven)
- STOP start: In accordance with the setting of valve action at STOP.



If the Startup tuning (ST) function is executed or an automatic temperature rise is made just when the power is turned on or selection is made from STOP to RUN as one of the startup conditions, control starts at Hot start 2 even if set to Hot start 1 (factory set value).



Control start mode when the controller recovers from power failure can be selected in Engineering mode. For details, refer to **7.5 Engineering Mode (P. 7-119)**.

### ■ Start determination point

In addition to Hot/Cold start selection, set the determination point of Hot start 1.

The Start determination point becomes the deviation setting from the Set value (SV).

- The start state is determined according to the Measured value (PV) level [deviation from set value] at power recovery.
- When a Measured value (PV) is between the determination points on the + (plus) and – (minus) sides, always started from Hot start 1 when recovered.
- When a Measured value (PV) is out of the determination points or the Start determination point is set at “0,” operation starts from any start state selected by Hot/Cold start.

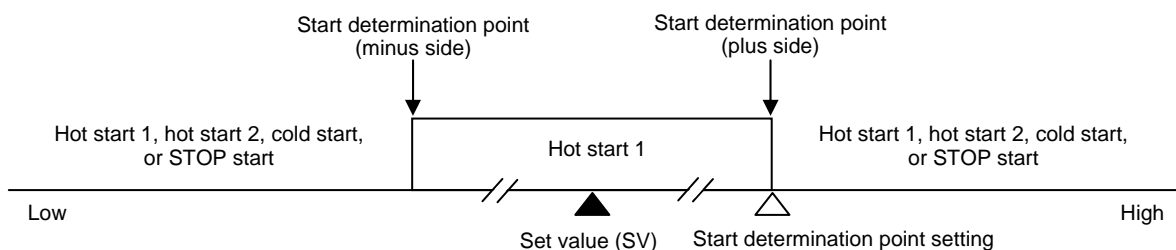

Start determination point setting is conducted in Engineering mode. For details, refer to **7.5 Engineering Mode (P. 7-120)**.

## 6.12 Position Proportioning PID Control

Position proportioning PID control converts the control output value of the controller into the corresponding signal to control a motor driven valve (control motor) and then performs temperature control of a controlled object by regulating fluid flow.

In Position proportioning PID control of this controller, it is possible to select the presence or absence of Feedback resistance (FBR) input which monitors the degree of valve position (Specify when ordering). In addition, the direct action or reverse action can be selected.

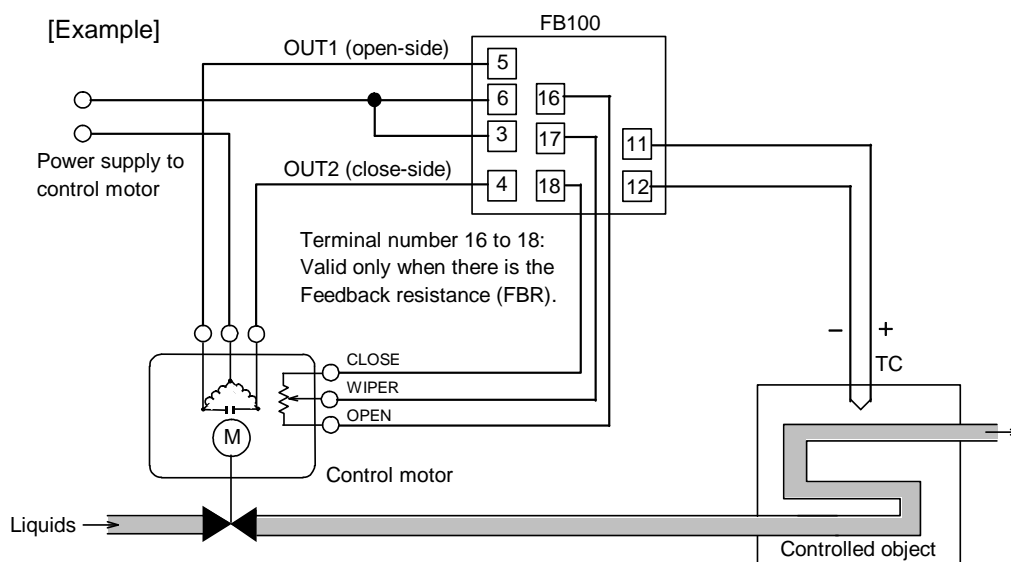

The details of setting differ depending on the presence or absence of Feedback resistance (FBR) input.

When there is a Feedback resistance (FBR) input:

- High/Low limit of valve position (limit value of FBR input) can be set. [Output limiter high, Output limiter low]
- Valve position can be manually set. [Manipulated output value (MV) setting in manual mode]
- Feedback adjustment is necessary. [Feedback adjustment]
- Action at Feedback resistance (FBR) input error can be selected. [Action at Feedback resistance (FBR) input error]
- Output value (FBR input) with the output turned on or off when the Autotuning (AT) function is executed can be restricted. [Output value with AT turned on, Output value with AT turned off]
- The close-side (or open-side) output remains ON when the valve position is fully closed (or opened). [Action at saturated output]

When there is no Feedback resistance (FBR) input:

- Control motor operation can be restricted by the integrated output limiter. [Integrated output limiter]
- The UP or DOWN key is used to output opening or closing signal in manual mode.

UP key (open-side): While the UP key is being pressed, open-side output (OUT1) is output continuously. Releasing the UP key turns off the open-side output to hold the opened state at that time.

DOWN key (close-side): While the DOWN key is being pressed, close-side output (OUT2) is output continuously. Releasing the DOWN key turns off the close-side output to hold the opened state at that time.

☞ For manual operation in Position proportioning PID control, refer to **6.7 Auto/Manual Transfer (P. 6-23)**.

**Parameter valid/invalid depending on the presence or absence of Feedback resistance (FBR) input** (× : Valid, – : Invalid)

Parameter (Engineering mode)	With Feedback resistance (FBR) input	Without Feedback resistance (FBR) input
Manipulated output value (MV) at STOP mode ( $r\bar{n}H\ l$ ) [Function block 51]	×	–
Output limiter high ( $\sigma L H$ ) Output limiter low ( $\sigma L L$ ) [Function block 51]	×	–
Output value with AT turned on ( $R\Gamma \sigma n$ ) Output value with AT turned off ( $R\Gamma \sigma F$ ) [Function block 52]	×	–
Open/Close output neutral zone ( $\Psi db$ ) * [Function block 53]	×	×
Open/Close output differential gap ( $\Psi HS$ ) * [Function block 53]	×	×
Action at feedback resistance (FBR) input error ( $\Psi br$ ) [Function block 53]	×	–
Feedback adjustment ( $P\sigma S$ ) [Function block 53]	×	–
Control motor time ( $\bar{n}\sigma\Gamma$ ) * [Function block 53]	×	×
Integrated output limiter ( $\sigma L R$ ) [Function block 53]	–	×
Valve action at STOP ( $HRL$ ) * [Function block 53]	×	×
Action at saturated output ( $\Psi RS\sigma$ ) [Function block 53]	×	–

\* These parameters are necessary to set regardless of the presence or absence of Feedback resistance (FBR) input.



Position proportioning PID control can be performed if two output points are selected when ordering.



Startup tuning (ST) cannot be executed by Position proportioning PID control. In addition, the Output change rate limiter also becomes invalid.



## ■ Setting flowchart

This section describes the Position proportioning PID control dedicated setting items and the setting items which are effective when there is or is not a Feedback resistance (FBR) input. The following setting items are all set in the Engineering mode.

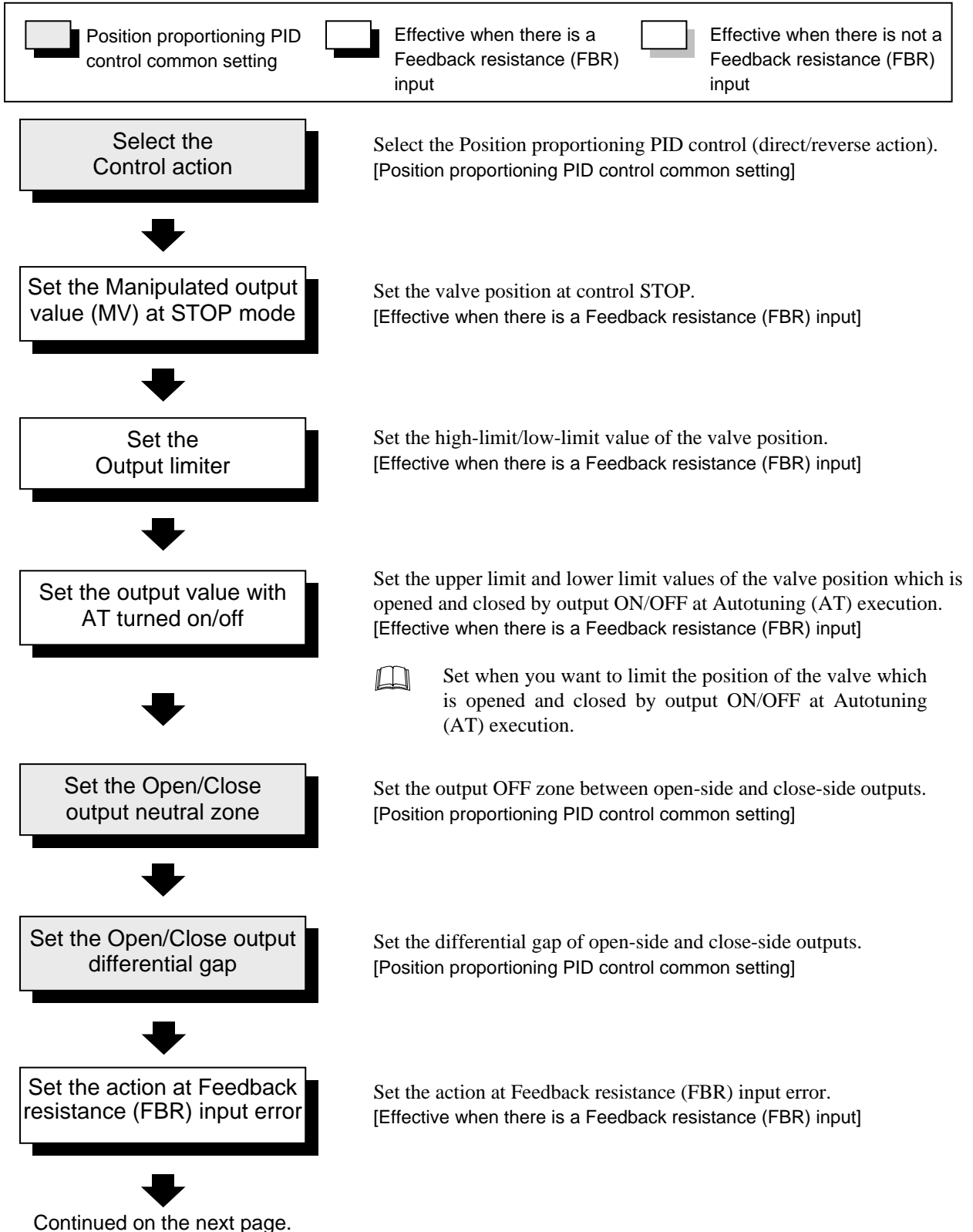

Continued from the previous page.

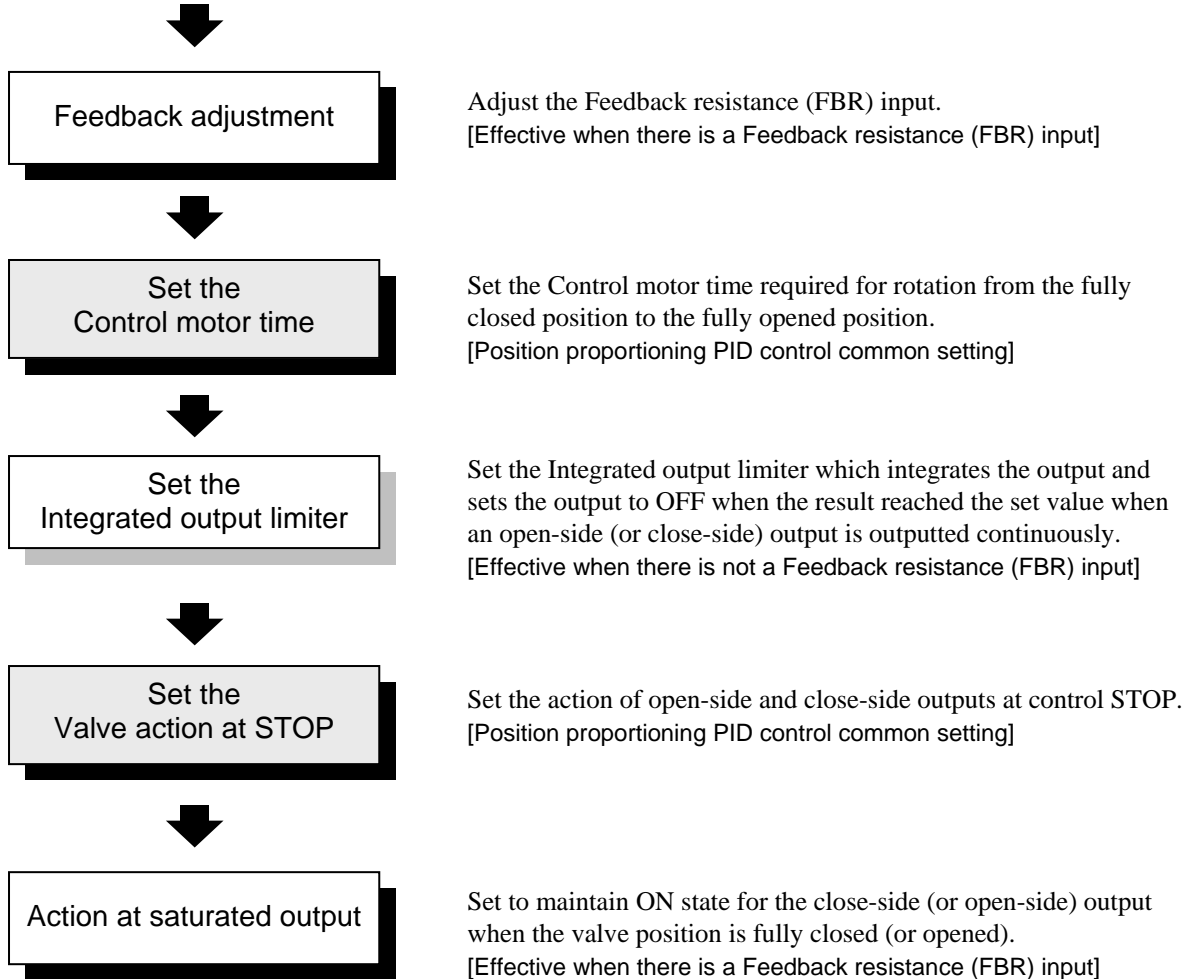

## ■ Setting procedures

### ● When there is a Feedback resistance (FBR) input

1. When set the parameter in Engineering mode, change the operation mode from RUN mode to STOP mode.

 To change from STOP mode to RUN mode, refer to **6.4 RUN/STOP Transfer (P. 6-11)**.

2. Press the Shift key while pressing the SET key for 2 seconds at PV/SV monitor screen until Engineering mode is displayed. Function block 10 screen is displayed first.

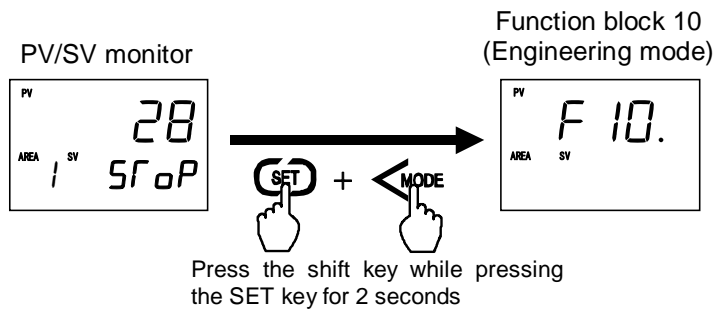

3. Press the UP or DOWN key until Function block 51 screen is displayed.

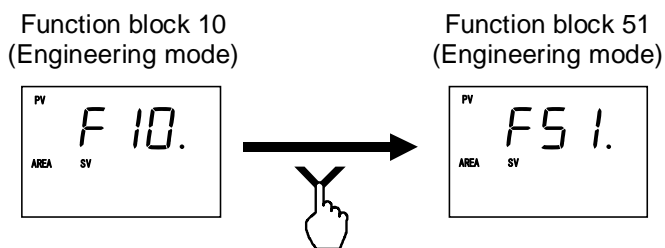

4. Press the SET key to change the control action setting screen.

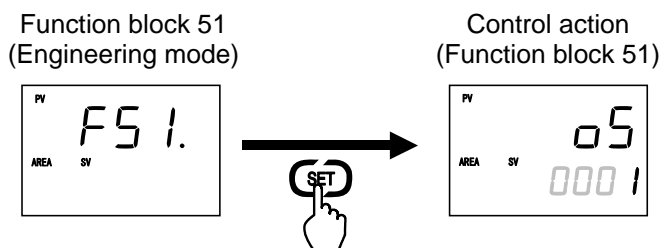

5. Press the UP key to change the control action from “1: PID control (reverse action)” to “5: Position proportioning PID control (reverse action).” Then, press the SET key to store the new value.

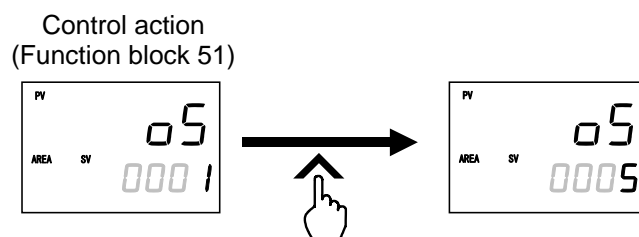

6. Set the following parameters Manipulated output value (MV1) at STOP mode, Output limiter high (MV1), and Output limiter low (MV1) in the same way as described above.

• **Manipulated output value (MV1) at STOP mode [Function block 51]**



Set the valve position at control STOP.

Setting range: -5.0 to +105.0 % (Factory set value: -5.0)

• **Output limiter high (MV1) [Function block 51]**



Set the high-limit value of the valve position.

Setting range: Output limiter low (MV1) to +105.0 %  
(Factory set value: 105.0)

• **Output limiter low (MV1) [Function block 51]**

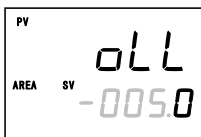

Set the low-limit value of the valve position.

Setting range: -5.0 % to Output limiter high (MV1)  
(Factory set value: -5.0)

7. Set the parameters Output value with AT turned on and Output value with AT turned off after changing to the Function block 52 screen by key operation.



Set when you want to limit the position of the valve which is opened and closed by output ON/OFF at Autotuning (AT) execution.

• **Output value with AT turned on [Function block 52]**



Set the upper limit values of the valve position (Feedback resistance input) which is opened and closed by output ON/OFF at Autotuning (AT) execution.

Setting range: Output value with AT turned off to 105.0 %  
(Factory set value: 105.0)  
However, within output limiter

• **Output value with AT turned off [Function block 52]**



Set the lower limit values of the valve position (Feedback resistance input) which is opened and closed by output ON/OFF at Autotuning (AT) execution.

Setting range: -105.0 % to Output value with AT turned on  
(Factory set value: -105.0)  
However, within output limiter

8. Set the following parameters after changing to the Function block 53 screen.  
Also, execute the feedback adjustment of the Feedback resistance (FBR) input.

- Open/Close output neutral zone
- Open/Close output differential gap
- Action at Feedback resistance (FBR) input error
- Control motor time
- Valve action at STOP
- Action at saturated output



The parameter display order is shown below.

Open/Close output neutral zone → Open/Close output differential gap → Action at Feedback resistance (FBR) input error → Feedback adjustment → Control motor time → Valve action at STOP

- **Open/Close output neutral zone [Function block 53]**



Set the output OFF zone between open-side and close-side outputs.  
Setting range: 0.1 to 10.0 % of output (Factory set value: 2.0)

- **Open/Close output differential gap [Function block 53]**

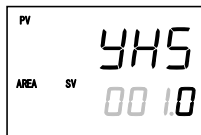

Set the differential gap of open-side and close-side outputs.  
Setting range: 0.1 to 5.0 % of output (Factory set value: 1.0)

- **Action at Feedback resistance (FBR) input error [Function block 53]**



Set the action at Feedback resistance (FBR) input error.  
Setting range: 0: Depending on the valve action at STOP  
1: Control action continued  
(Factory set value: 0)

**For the feedback adjustment, refer to the next page.**

- **Control motor time [Function block 53]**



Set the Control motor time required for rotation from the fully closed position to the fully opened position.

Setting range: 5 to 1000 seconds (Factory set value: 10)



If Feedback adjustment is performed, the control motor driving time is automatically computed. However, if the time thus computed is less than 5 seconds, no set value is updated.

Continued on the next page.

• **Valve action at STOP [Function block 53]**



Set the action of open-side and close-side outputs at control STOP.  
 Setting range: 0: Close-side output OFF, Open-side output OFF  
 1: Close-side output ON, Open-side output OFF  
 2: Close-side output OFF, Open-side output ON  
 (Factory set value: 0)

• **Action at saturated output [Function block 53]**



Set to maintain ON state for the close-side (or open-side) output when the valve position is fully closed (or opened).  
 Setting range: 0: Invalid (The close-side [or open-side] output turns to OFF when the valve position is fully closed [or opened]).  
 1: Valid (The close-side [or open-side] output remains ON state when the valve position is fully closed [or opened]).  
 (Factory set value: 0)

• **Feedback adjustment [Function block 53]**



Adjust the Feedback resistance (FBR) input.  
 After the adjustment, the manipulated output value from 0 to 100 % obtained after PID computation matches the valve position signal of the fully closed position to the fully opened position [Feedback resistance (FBR) input] sent from the control motor.

At the adjustment preparation screen, press and hold the Shift key for 5 seconds to start the adjustment. The display automatically return to the adjustment preparation screen after the adjustment is completed.

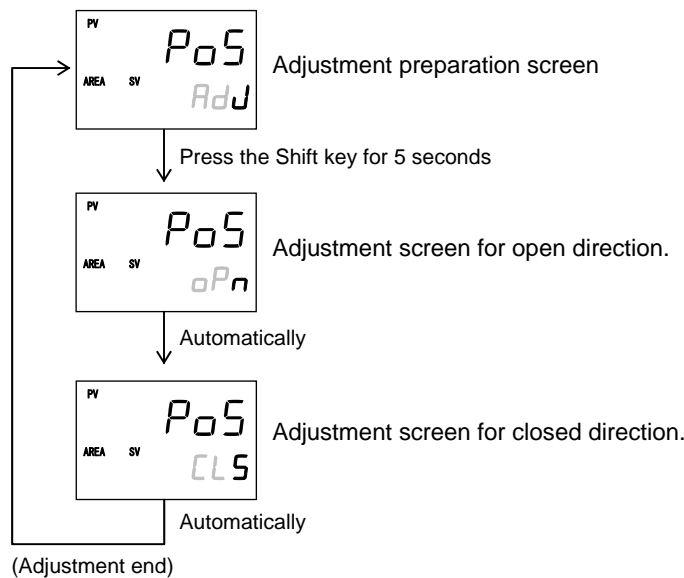

Display returns to the PV/SV monitor screen if no key operation is performed within 1 minute (except during the Feedback adjustment).

- At the end of setting of each parameter and Feedback adjustment of the Feedback resistance (FBR) input, return to the PV/SV monitor screen and then refer to **6.4 RUN/STOP Transfer (P.6-11)** and set to the control RUN state.

- **When there is no Feedback resistance (FBR) input**

1. Refer to steps 1 to 5 (P. 6-47) of **When there is a Feedback resistance (FBR) input** and set the control action to Position proportioning PID control (direct or reverse action).
2. Refer to step 8 (P. 6-49) of **When there is a Feedback resistance (FBR) input** and set the Open/Close output neutral zone, Open/Close output differential gap, Control motor time, and Valve action at STOP. In addition, also set Integrated output limiter.



The parameter display order is shown below.

Open/Close output neutral zone → Open/Close output differential gap → Control motor time → Integrated output limiter → Valve action at STOP

- **Integrated output limiter [Function block 53]**



Set the Integrated output limiter which integrates the output and sets the output to OFF when the result reached the set value when an open-side (or close-side) output is outputted continuously.

Setting range: 0.0 to 200.0 % of control motor time

0.0: Integrated output limiter function OFF

(Factory set value: 150.0)



Since the output is integrated when the open-side (or close-side) output is outputted continuously, once the inverted output is outputted, the integrated value is reset.

[Example] If control is started at the fully closed state when the Control motor operation time is set at 10 seconds and the Integrated output limiter value is set at 100 %, the following results.

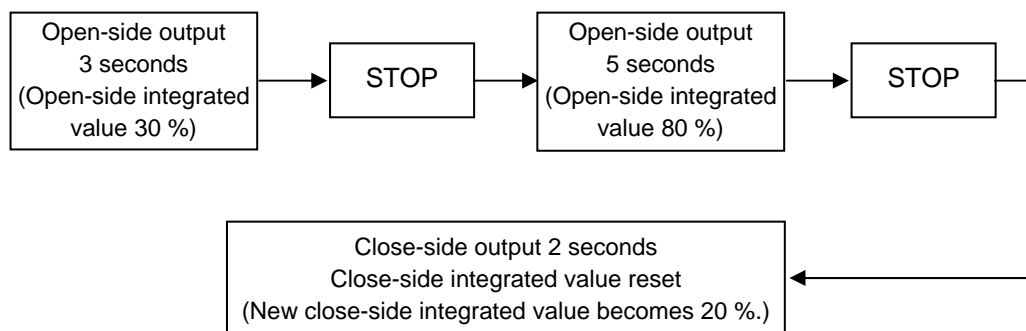

3. At the end of setting of each parameter, return to the PV/SV monitor screen and then refer to **6.4 RUN/STOP Transfer (P. 6-11)** and set to the control RUN state.

## 6.13 Ramp/Soak Control

Ramp/Soak control of this instrument realizes simple Ramp/Soak control by linking a number of memory areas having different Set values (SV).

Simple Ramp/Soak control is possible by setting a Set value (SV), Setting change rate limiter (up/down), Area soak time, and Link area number in each memory area.

- Set value (SV): Sets the fixed set point control (control by fixed set value) desired value of each memory area.
- Setting change rate limiter: Sets the slope of the Set value (SV) which is raised or lowered at each unit time.
- Area soak time: Sets the fixed set point control time of each memory area.
- Link area number: Sets the memory area numbers for linking the corresponding memory areas.



Besides the above, the Setting change rate limiter unit time and Area soak time unit are set in the Engineering mode.



**When the value of Digital input (DI) assignment (Engineering mode) is 6 to 12, Ramp/Soak control cannot be performed. To perform Ramp/Soak control, set the value of Digital input (DI) assignment to other than 6 to 12.**

Example: Ramp/Soak control by linking Memory area 1 to 3

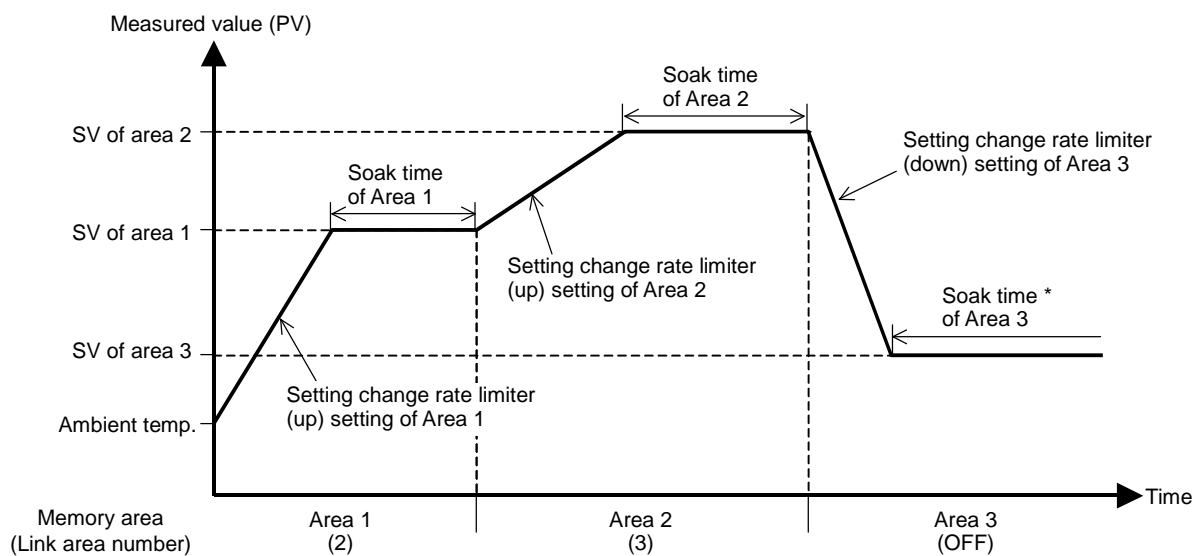

\* As the area soak time for memory area linked last becomes invalid, the state of SV3 reached continues.



### ■ Operation flowchart

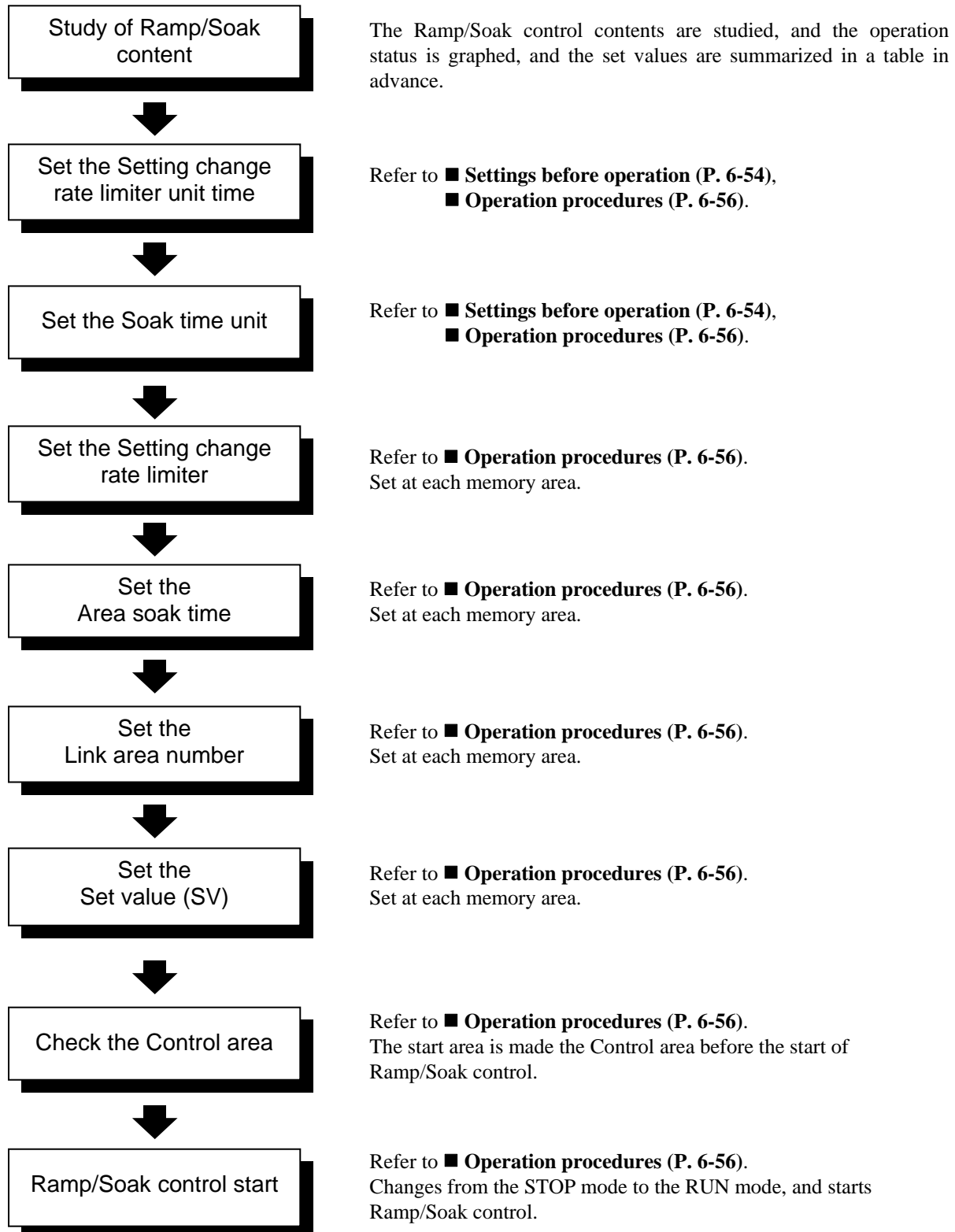

## ■ Settings before operation

When implementing Ramp/Soak control, it may be necessary to set the following items in advance.

- Setting change rate limiter unit time [Engineering mode: Function block 70]
- Soak time unit [Engineering mode: Function block 70]

1. Change the operation mode from RUN mode to STOP mode.

 To change from RUN mode to STOP mode, refer to **6.4 RUN/STOP Transfer (P. 6-11)**.

2. Press the Shift key while pressing the SET key for 2 seconds at PV/SV monitor screen until Engineering mode is displayed. Function block 10 screen is displayed first.

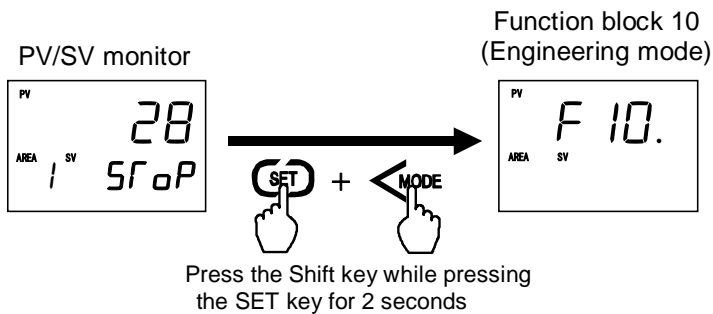

3. Press the UP or DOWN key until Function block 70 screen is displayed.

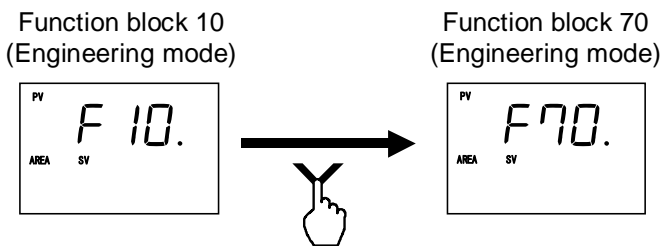

4. Press the SET key to change the screen to the setting change rate limiter unit time setting screen.

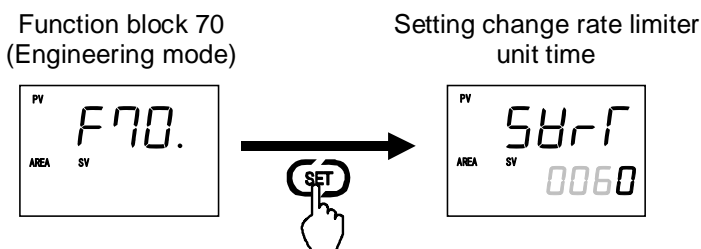

5. Set the Setting change rate limiter [amount of change of the Set value (SV) per unit time when the Set value (SV) is changed] by pressing the Shift key and the UP key or DOWN key. If unnecessary to be changed, use their factory set values.

Setting range: 1 to 3600 seconds (Factory set value: 60)

Setting change rate limiter unit time



Setting example

- SV (°C)/sec. → Set 1 second
- SV (°C)/min. → 60 seconds (factory set value)
- SV (°C)/30 min. → Set 1800 seconds
- SV (°C)/hour → Set 3600 seconds



After a new value is displayed on the display by using UP and DOWN keys, if no key operation is performed within 1 minute without pressing SET key, this instrument returns to the PV/SV monitor screen and the Setting change rate limiter unit time will not be changed.

- Press the SET key to store the new Setting change rate limiter unit time. The screen goes to the Soak time unit.

Setting change rate limiter  
unit time

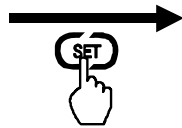

Soak time unit



- Select the Area soak time unit which needs to be changed by pressing the UP or DOWN key. If unnecessary to be changed, use their factory set values.

Setting range: 0: 0 time 00 minute to 99 times 59 minutes  
1: 0 minute 00 second to 199 minutes 59 seconds  
(Factory set value: 1)

Soak time unit

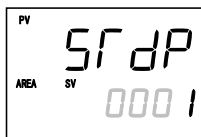

After a new value is displayed on the display by using UP and DOWN keys, if no key operation is performed within 1 minute without pressing SET key, this instrument returns to the PV/SV monitor screen and the time unit of the Area soak time will not be changed.

- Press the SET key to store the new time unit of the Area soak time. The screen returns to the first parameter (Function block 70).

Soak time unit

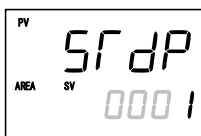

Function block 70

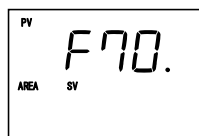

- To return the PV/SV monitor, press the Shift key while pressing the SET key.

■ **Operation procedures**

This section uses the following sample of Ramp/Soak control to describe the operation procedures.

[Example: Ramp/Soak control by linking memory area 1 to 3]

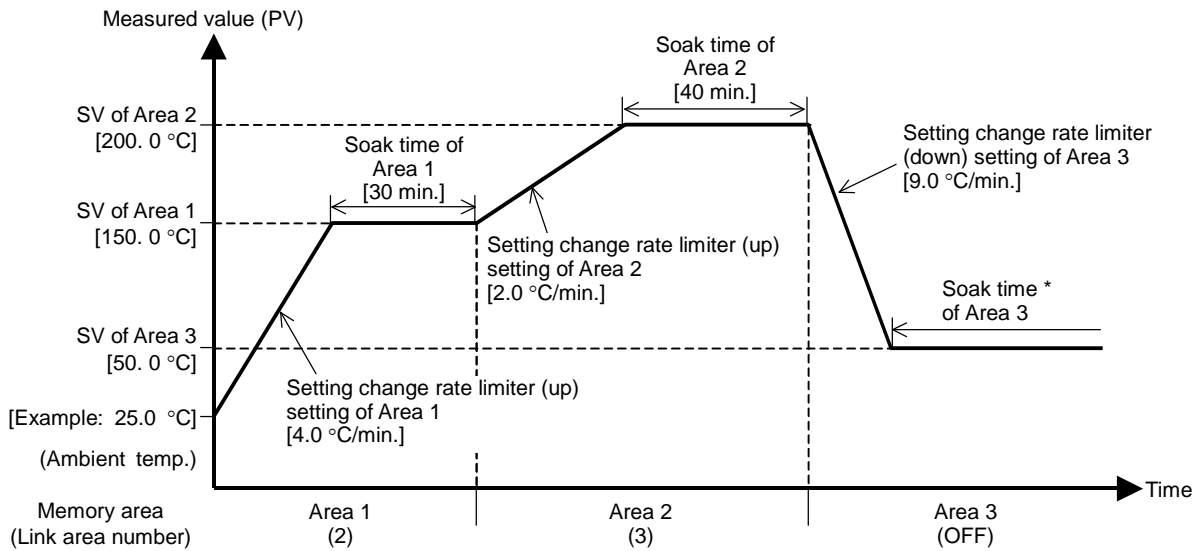

	Area 1	Area 2	Area 3
Set value (SV)	150.0 °C	200.0 °C	50.0 °C
Setting change rate limiter (up) [SVrU]	4.0 °C/min. (60 sec.)	2.0 °C/min. (60 sec.)	OFF
Setting change rate limiter (down) [SVrd]	OFF	OFF	9.0 °C/min. (60 sec.)
Area soak time [AST]	30 min.	40 min.	0 min. *
Link area number [LnKA]	2	3	OFF

\* In this example, the Area soak time for memory area 3 is set. However, as the Area soak time for the memory area linked last becomes invalid, the state of SV3 reached continues.

Step 1:  
Study the Ramp/Soak control content.

The Ramp/Soak control contents are studied and Ramp/Soak status is graphed and the set values of each memory area are summarized in a table as shown above.

Step 2:  
Set the setting change rate limiter unit time and soak time unit of function block 70.

Refer to ■ **Settings before operation (P. 6-54)** and set the Setting change rate limiter unit time and Area soak time (In this example, the factory set values are used for both). Since control stops (STOP) at this time, go directly to the next step.

- Setting change rate limiter unit time (SVrT): 60 seconds [factory set value]
- Soak time unit (STdP): 1 (0 minutes 00 seconds to 199 minutes 59 seconds) [factory set value]

**Step 3:**

Set the setting change rate limiter, area soak time and link area number to each of memory area 1, 2 and 3.

1. Press the SET key at Parameter setting mode until Setting change rate limiter (up) setting screen is displayed.

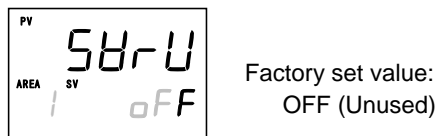

2. Press the UP key to change the number to 4.0.

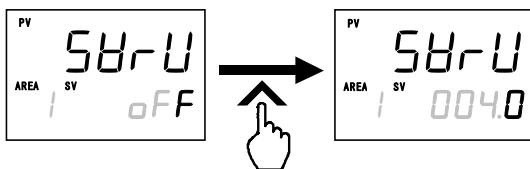

3. Press the SET key to store the new value. The display goes to the next parameter. Check that this screen is set to OFF.

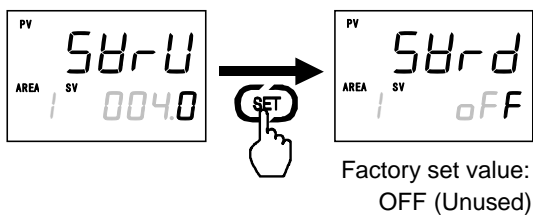

4. Press the SET key until Area soak time setting screen is displayed.

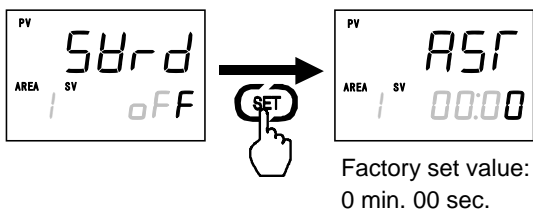

5. Press the Shift key to high-light the tens place of "minute."

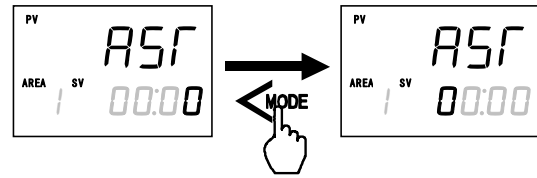

6. Press the UP key to change the number to 3.

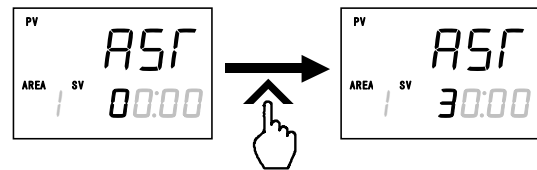

7. Press the SET key to store the new value. The display goes to the next parameter.

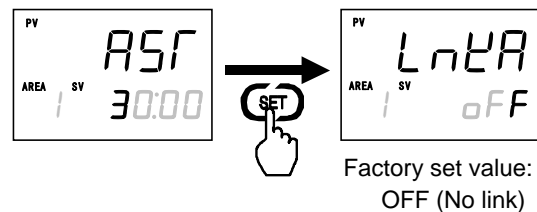

8. Press the UP key and change the Memory area 1 Link area number to 2.

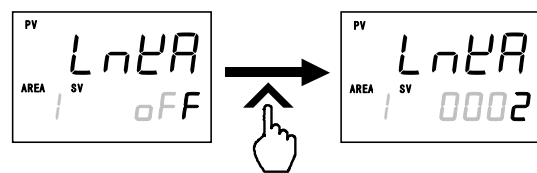

9. Press the SET key to store the new value. The display goes to the next parameter.

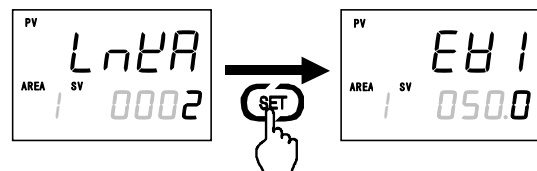

**10. Set the Memory area 2.**

Press the SET key several times until Setting change rate limiter (up) setting screen is displayed. The screen set at step 2 is displayed.

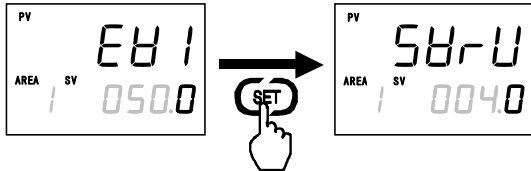

**11. Press the Shift key until Memory area display unit is high-lighted.**

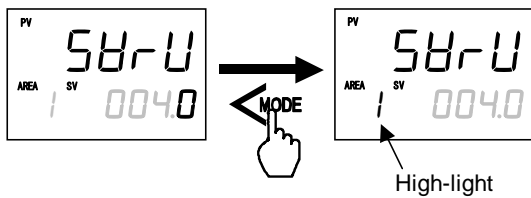

**12. Press the UP key to change to 2. Area number display flashes. \***

\* The area number display flashes to indicate that the area number now displayed differs from the control area.

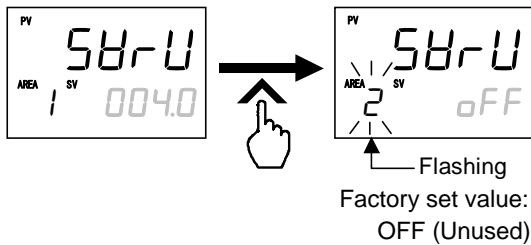

**13. Press the Shift key to high-light the least significant digit.**

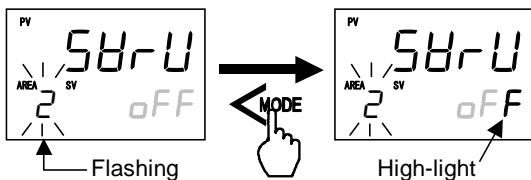

**14. Set the Memory area 3 Setting change rate limiter, Area soak time, and Link area number by the same procedures as described in steps 3 to 9.**

**15. Set the Memory area 3.**

Press the SET key several times until Setting change rate limiter (up) setting screen of the Memory area 2 is displayed.

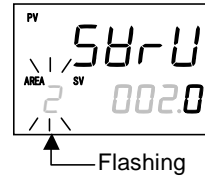

**16. Press the shift key to high-light (flashing) the Memory area display unit.**

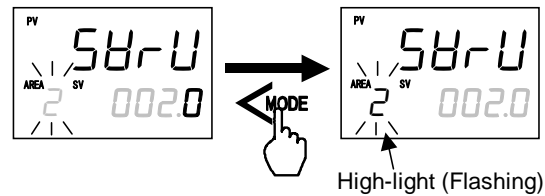

**17. Press the UP key to change to 3. Area number display flashes.**

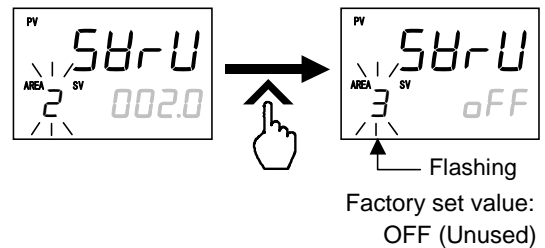

**18. Set the Memory area 3 Setting change rate limiter, Area soak time, and Link area number by the same procedures as described in steps 3 to 9. However, in the case of this Ramp/Soak control sample, the Area soak time is invalid, even if set, because Memory area 3 is linked last.**

Step 4:  
Set the SV to each of memory area 1, 2 and 3.

1. Press and hold the SET key for 2 seconds to change the mode from parameter setting mode to SV setting & monitor mode. PV/SV monitor screen is displayed.

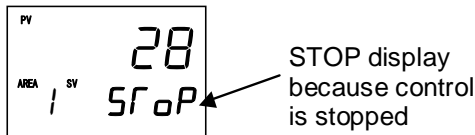

 Changed to the SV setting & monitor mode even if the Shift key is pressed while pressing the SET key.

2. Press the SET key until Set value (SV) setting screen of Memory area 1 is displayed.

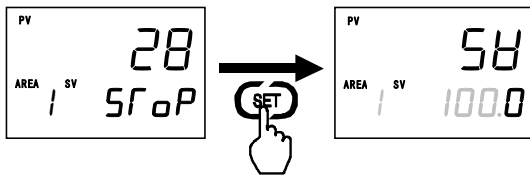

3. Press the Shift key to high-light the tens place.

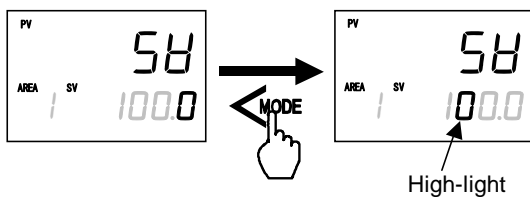

4. Press the UP key to change the number to 5.

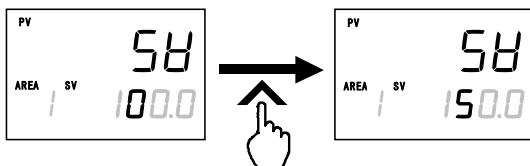

5. Press the SET key to store the new value. The display goes to the next parameter.

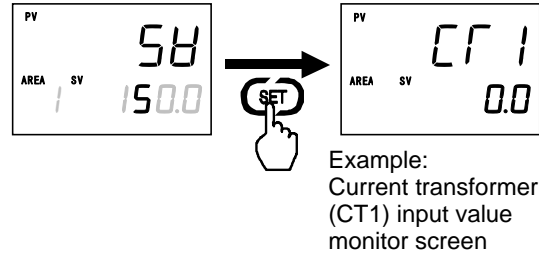

6. Set the Set value (SV) of Memory area 2. Press the SET key several times until Set value (SV) setting screen of Memory area 1 is displayed. The screen set at step 4 is displayed.

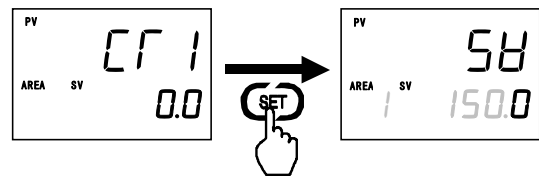

7. Press the Shift key to high-light the Memory area display unit.

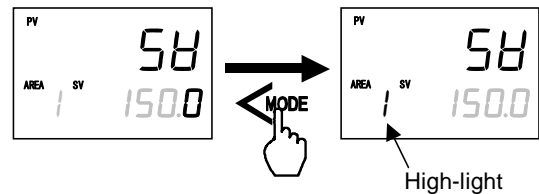

8. Press the UP key to change the number to 2. The number in AREA (Area number) display flashes.

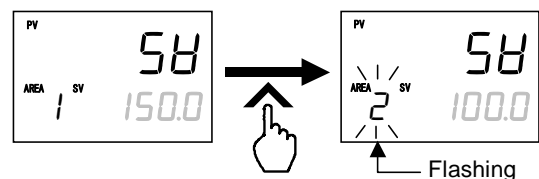

9. Press the Shift key to high-light the hundreds place.

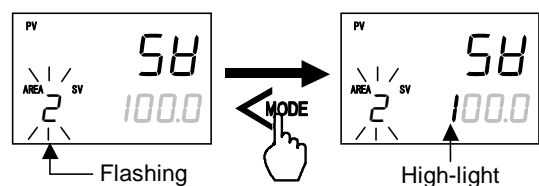

10. Hereinafter, set the Memory areas 2 and 3 Set value (SV) by the same procedure.

Step 5:  
Check the control area number.

- **When the Direct key type is other than Monitor**

Press the SET key several times at SV setting & monitor mode until Memory area transfer setting screen is displayed. Check that the memory area at the time of operation start corresponds to Memory area 1.

- **When the Direct key type is Monitor**

Press the Direct key until Memory area transfer screen is displayed. Check that the memory area at the time of operation start corresponds to Memory area 1.



The Direct key type is selected in Engineering mode.  
The factory set value is Auto/Manual transfer.



Memory area transfer setting screen

Step 6:  
Change from STOP mode to RUN mode

When **6.4 RUN/STOP Transfer (P. 6-11)** is referenced and the control RUN state is selected, Ramp/Soak control starts.



## 6.14 Group Operation by the Intercontroller Communication

Intercontroller communication exchanges data between multiple FB100/400/900 (hereinafter referred to as “controller”) without using remote setting input and analog output and other analog signals and host computer communications.

The following four functions become usable when the Intercontroller communication is used.

- Group RUN/STOP function
- Automatic temperature rise function (with learning function)
- Cascade control function
- Ratio setting function

### CAUTION

- Since Intercontroller communication communicates by connecting multiple controllers (FB100/400/900), a time lag (maximum 70 ms × number of controllers connected) is always generated. Therefore, it may be impossible to cope with rapid response control systems. When performing Intercontroller communication, consider the operation delay caused by the time lag.
- Since Intercontroller communication recognizes the connected controllers when the power is turned OFF → ON, be sure that power to all the controllers engaged in Intercontroller communication is turned ON at the same time.



Intercontroller communication is possible on the FB100 when optional function is E, F, G, H or J is used.

### 6.14.1 Wiring method of the Intercontroller communication

In Intercontroller communication, perform multi-drop connection using the communication 2 port. Note that when the number of communication points on the FB100 is one point, the communication port of Communication 1 is used.

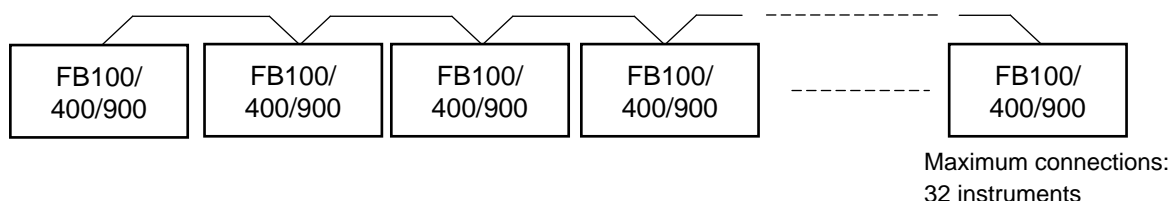

#### ● Communication terminal number and signal details

FB100: Communication 1  
(Optional function: E, F, H, J)

Terminal No.	Signal name	Symbol
13	Signal ground	SG
14	Send data/Receive data	T/R (A)
15	Send data/Receive data	T/R (B)

FB100: Communication 2  
(Optional function: G)

Terminal No.	Signal name	Symbol
16	Signal ground	SG
17	Send data/Receive data	T/R (A)
18	Send data/Receive data	T/R (B)

FB400/900: Communication 2

Terminal No.	Signal name	Symbol
25	Signal ground	SG
28	Send data/Receive data	T/R (A)
29	Send data/Receive data	T/R (B)

● **Wiring example**

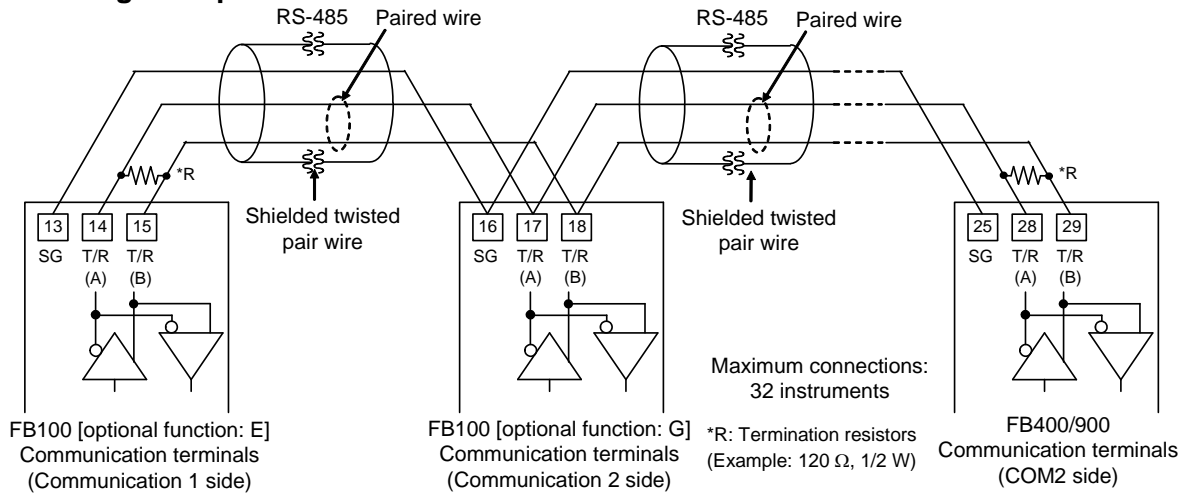

### 6.14.2 Common setting of the Intercontroller communication

When performing Intercontroller communication, Device address must be set for all the controllers engaged in the Intercontroller communication.

● **Set the Device address**

[When there are two FB100 communication points (optional function: G)]

As there are two communication points and Communication 2 is used in Intercontroller communication, Device address 2 must be set.

1. Press the Shift key while pressing the SET key at PV/SV monitor screen until Setup setting mode is displayed. The screen displayed first differs depending on the specification.

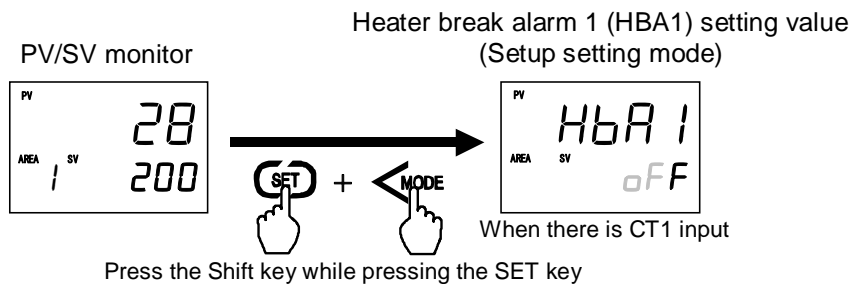

2. Press the SET key until Device address 2 screen is displayed.

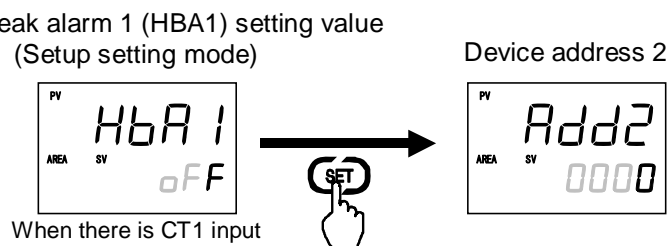



3. Set the address by pressing the UP or DOWN keys.

Setting range: 0 to 31 (Factory set value: 0)

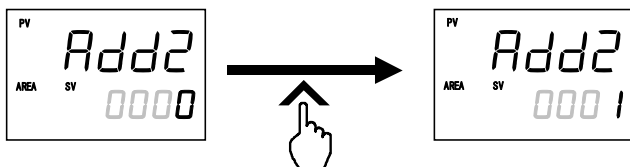
Device address 2



 Always set the address of controller to the number in succession starting from 0.

 After a new value is displayed on the display by using UP and DOWN keys, if no key operation is performed within 1 minute without pressing SET key, this instrument returns to the PV/SV monitor screen and the address will not be changed.

4. Press the SET key to store the new address. The screen goes to the next parameter.

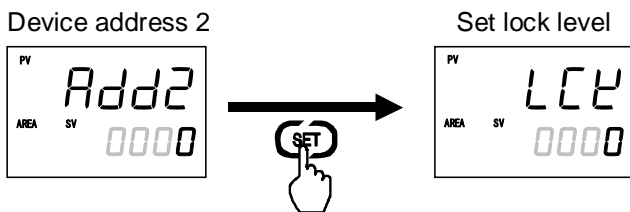

5. To return the PV/SV monitor, press the Shift key while pressing the SET key.

6. Set the address of the other controllers by the same procedures as described in steps 1 to 5 above.



 To perform Intercontroller communication on the FB100 when the number of communication points is one (optional functions E, F, H, J), the Communication 1 protocol (Engineering mode: Function block 60) must be set to “2: Intercontroller communication.” When the number of communication points on the FB100 is two (optional function G), or when the FB400/900 is used, the Communication 2 protocol (Engineering mode: Function block 60) must be set to “2: Intercontroller communication.” However, when Intercontroller communication cannot be executed successfully, check the Communication protocol setting.

 For one-point communication on the FB100 (optional functions E, F, H, J), set Device address 1.

 When Intercontroller communication is performed using Communication 1, settings related to Communication 1 other than Device address 1 (Communication speed 1, Data bit configuration 1, and Interval time 1) are disregarded. When Intercontroller communication is performed, the setup screen related to Communication 2 other than Device address 2 (Communication speed 2, Data bit configuration 2, and Interval time 2) is not displayed.

### 6.14.3 Group RUN/STOP function

The group RUN/STOP function makes multiple controllers one group and if even one controller in the group is set to the RUN/STOP state, it places all the controllers in that group into the RUN/STOP state.

-  When executing group RUN/STOP at Intercontroller communication, a time lag (maximum  $70 \text{ ms} \times \text{number of controllers connected}$ ) up to actual transfer after operation is generated. For example, when RUN/STOP operation is repeated by different controllers in a short time, the last operation and actual controller state may be different. Therefore, be especially careful of the RUN/STOP transfer timing.
-  The maximum number of connectable controllers at Intercontroller communication is 32, without regard to the number of groups.
-  When the group RUN/STOP function is used at automatic temperature rise by Intercontroller communication, all the controllers in the group can start temperature rise simultaneously.

#### ■ Operation flowchart

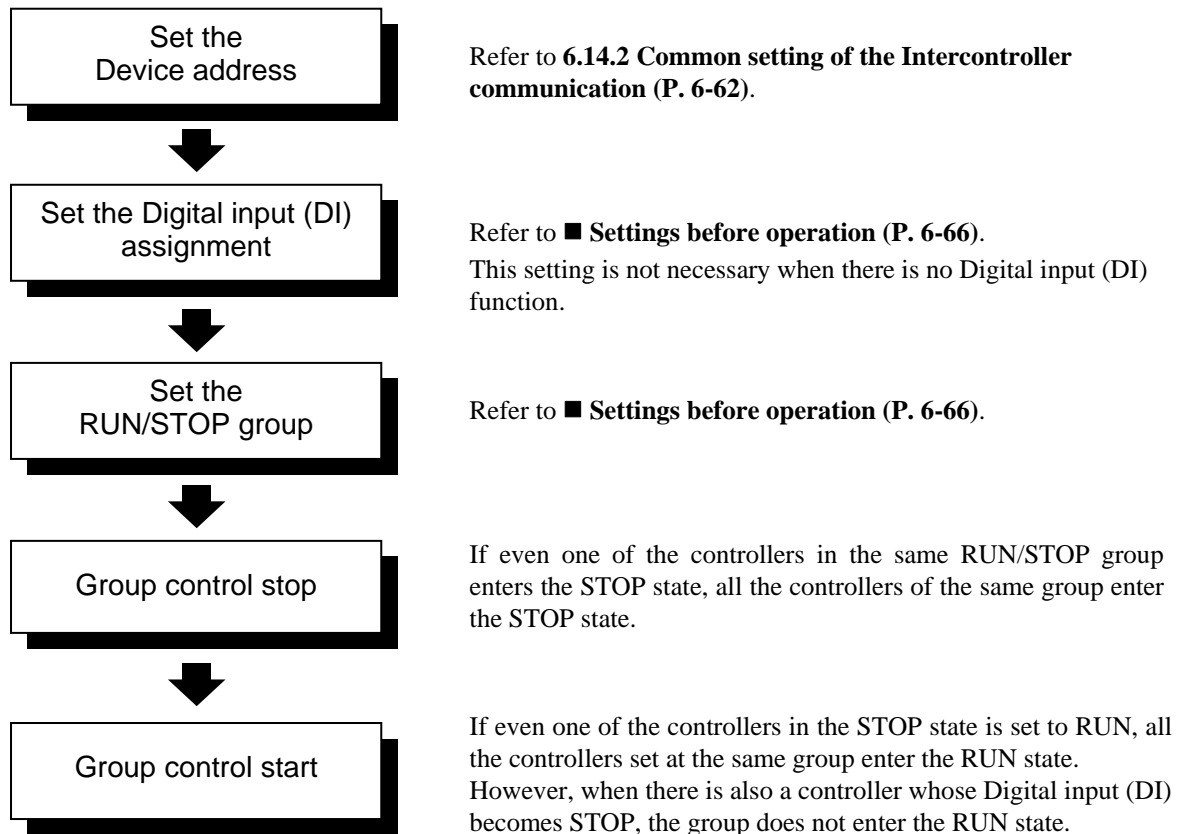

-  For each status by RUN/STOP operation, refer to **■ Group RUN/STOP operation and states (P. 6-65)** and **■ Usage example (P. 6-69)**.

## ■ Requirements for Group RUN/STOP

### ● Control stop (STOP) by group RUN/STOP condition

If there is even one controller in the same group, when STOP is selected by Key operation, Communication, or Digital input (DI), it enters the STOP state.

### ● Control start (RUN) by group RUN/STOP condition

If there is even one controller in the same group, when RUN is selected by Key operation, Communication, or Digital input (DI), it enters the RUN state.

However, if there is even one controller whose Digital input (DI) becomes STOP, it does not enter the RUN state.



**When RUN/STOP selection by Digital input (DI) and RUN/STOP selection by key operation or communication are different, the STOP state is entered. (STOP priority)**



Group RUN/STOP transfer by Digital input (DI) can be executed when optional function E, F or J is used.

## ■ Group RUN/STOP operation and states

The actual RUN/STOP state is different for RUN/STOP by Key operation, Digital input, and Communications. The following shows the relationship between each operation and the actual RUN/STOP state.

### ● When there is no RUN/STOP transfer by the digital input (DI)

RUN/STOP mode from key operation or communication	Actual RUN/STOP mode state	State of STOP character display
STOP	STOP	STOP (SToP)
RUN	RUN	STOP is not displayed

### ● When there is RUN/STOP transfer by the digital input (DI)

RUN/STOP mode from key operation or communication	RUN/STOP mode by Digital input (DI)	Actual RUN/STOP mode state	State of STOP character display
STOP	Contact open (STOP)	STOP	STOP (SToP)
	Contact closed (RUN)		KSTOP (KSTP)
RUN	Contact open (STOP)	RUN	dSTOP (dSTP)
	Contact closed (RUN)		STOP is not displayed



Other than those above, the actual RUN/STOP state and STOP display may be different, depending on the RUN/STOP state by Digital input (DI) of the other controllers in the same group.

RUN/STOP mode from key operation or communication	RUN/STOP mode by Digital input (DI)	RUN/STOP selection by Digital input (DI) of other controllers in the same group.	Actual RUN/STOP mode state	State of STOP character display
RUN	Contact close (RUN) or Without DI	STOP	STOP	GSTOP (GSTP)

Refer to ■ Usage example (P. 6-69).

## ■ Settings before operation

When implementing the group RUN/STOP function, the following items must be set.

- Device address [Setup setting mode]
- Digital input (DI) assignment [Engineering mode: Function block 23]
- RUN/STOP group [Engineering mode: Function block 55]

 For the Device address setting, refer to **6.14.2 Common setting of the Intercontroller communication (P. 6-62)**.

1. Change the operation mode from RUN mode to STOP mode.

 To change from RUN mode to STOP mode, refer to **6.4 RUN/STOP Transfer (P. 6-11)**.

2. Press the Shift key while pressing the SET key for 2 seconds at PV/SV monitor screen until Engineering mode is displayed. The Function block 10 screen is displayed first.

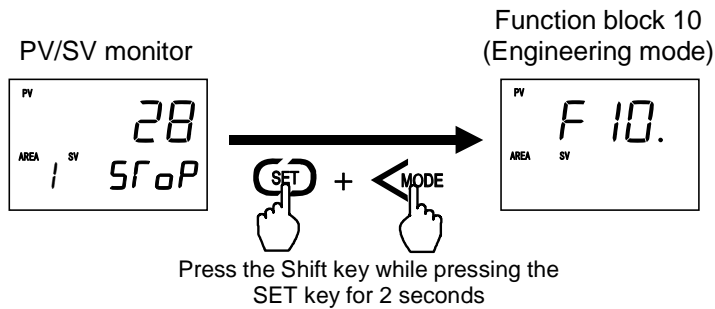

3. Press the UP or DOWN key until Function block 23 screen is changed.

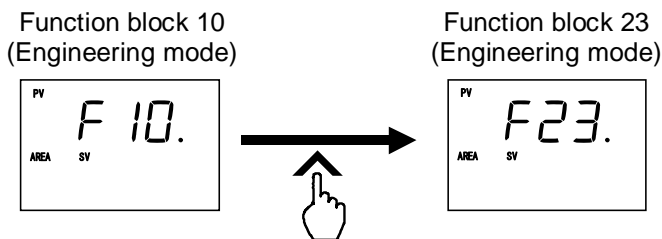

 If group RUN/STOP transfer by Digital input (DI) is not performed, skip steps 3 to 6.

4. Press the SET key to change the Digital input (DI) assignment screen.

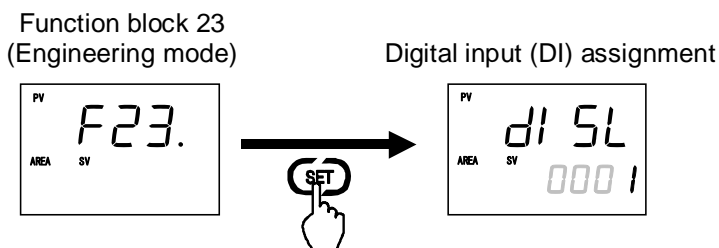

- Set the Digital input (DI) assignment by pressing the UP or DOWN keys.  
 If RUN/STOP transfer by Digital input (DI) is performed, set 13, 14, 15, 17, 18, 19, or 23.  
 Setting range: 1 to 26 (Factory set value: 1)  
 However, values 1 to 11 can only be set for optional function A, and thus the range that can be set for optional functions E, F and J which have both communication and Digital input (DI) is 12 to 26.

Digital input (DI) assignment

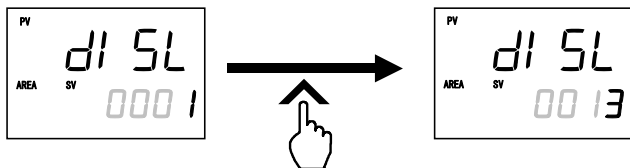

Set value	DI1	DI2	DI3	DI4	DI5	Selection Optional function
12	Memory area number transfer (1 to 8)					E
13	RUN/STOP	Remote/Local	Remote/Local			
14	RUN/STOP	Remote/Local	Interlock release			
15	RUN/STOP	Remote/Local	Interlock release			
16	Remote/Local	Remote/Local	Interlock release			E
17	RUN/STOP	Remote/Local				
18	RUN/STOP	Remote/Local				
19	RUN/STOP	Interlock release				
20	Remote/Local	Remote/Local				
21	Remote/Local	Interlock release				
22	Remote/Local	Interlock release				
23	RUN/STOP				E, F, J	
24	Remote/Local					
25	Remote/Local					
26	Interlock release					

- When performing group RUN/STOP transfer by Digital input (DI), wiring conservation and simple operation are possible by setting “RUN/STOP transfer by Digital input (DI)” for only one controller in the group.**
- Group RUN/STOP transfer by Digital input (DI) can be executed when optional function E, F or J is used.
- After a new value is displayed on the display by using UP and DOWN keys, if no key operation is performed within 1 minute without pressing SET key, this instrument returns to the PV/SV monitor screen and the Digital input (DI) assignment will not be changed.
- For the Digital input (DI) assignment, refer to **7.5 Engineering Mode (P. 7-80)**.

- Press the SET key to store the new Digital input (DI) assignment. The screen goes to the Function block 23 screen.

Digital input (DI) assignment

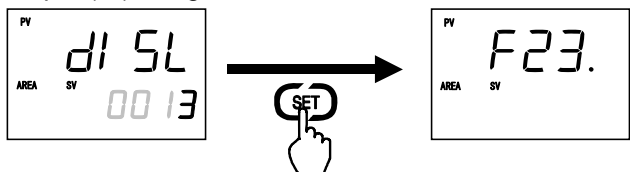

7. Press the UP or DOWN key until Function block 55 screen is displayed.

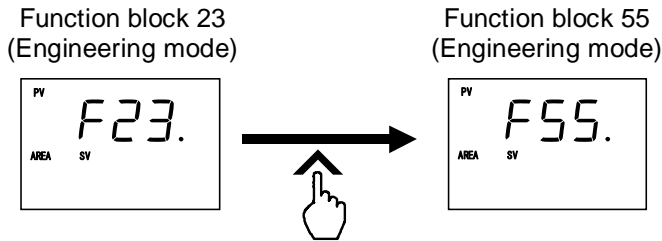

8. Press the SET key until RUN/STOP group setting screen is displayed.

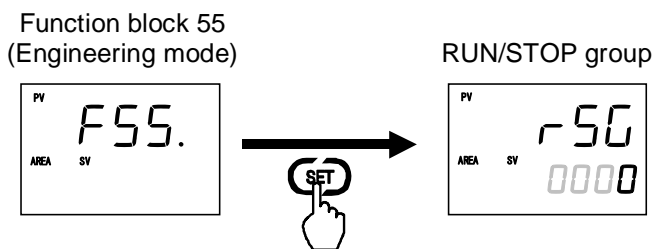

9. Set the RUN/STOP group number by pressing the UP or DOWN keys.

Setting range: 0 to 16 (Factory set value: 0)

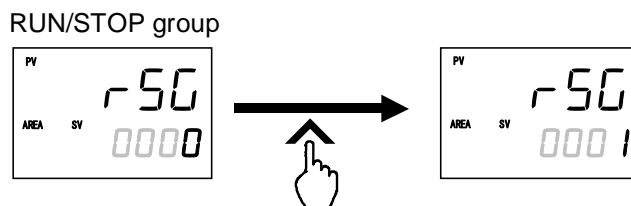

When the group number is set to “0,” the group RUN/STOP state of that controller becomes OFF.



After a new value is displayed on the display by using UP and DOWN keys, if no key operation is performed within 1 minute without pressing SET key, this instrument returns to the PV/SV monitor screen and the RUN/STOP group number will not be changed.

10. Press the SET key to store the new RUN/STOP group number. The screen goes to the next parameter.

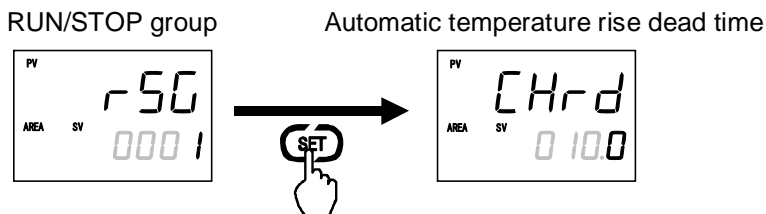

11. To return the PV/SV monitor, press the Shift key while pressing the SET key.

12. Set Digital input (DI) assignment and RUN/STOP group number of other controllers by the same procedure as that described in steps 1 to 11 above.



■ Usage example

When performing RUN/STOP by making 3 controllers one group.

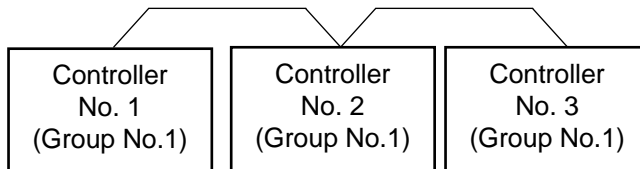

Connection status of the Intercontroller communication



The parts which become “DI” in the following description specify “RUN/STOP transfer by Digital input (DI).”

● Example 1: RUN/STOP by key operation

The following key operations perform the same action whether or not there is DI. The display at STOP is different when there is and when there isn't DI.

[When all 3 controllers do not have DI]

1. When controller No. 1 to 3 are in the RUN state, if any one of the controllers is placed into the STOP state by key operation, all the controllers in that group enter the STOP state.

STOP display at control STOP

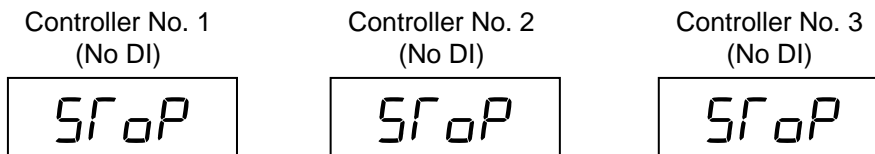

2. If any one of controller No. 1 to 3 is placed into the RUN state by key operation, all the controllers in that group enter the RUN state.

[When only controller No. 1 has DI]

1. When controller No. 1 to 3 are in the RUN state, if any one of the controllers is placed into the STOP state by key operation, all the controllers in that group enter the STOP state.

STOP display at control STOP

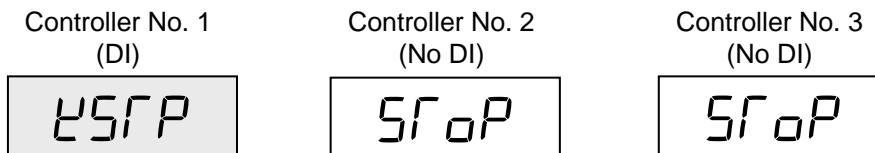

Display when stopped by key operation

2. If any one of controller No. 1 to 3 is placed into the RUN state by key operation, all the controllers in that group enter the RUN state.

[When controller No. 1 and No. 2 have DI]

1. When controller No. 1 to 3 are in the RUN state, if any one of the controllers is placed into the STOP state by key operation, all the controllers in that group enter the STOP state.

STOP display at control STOP

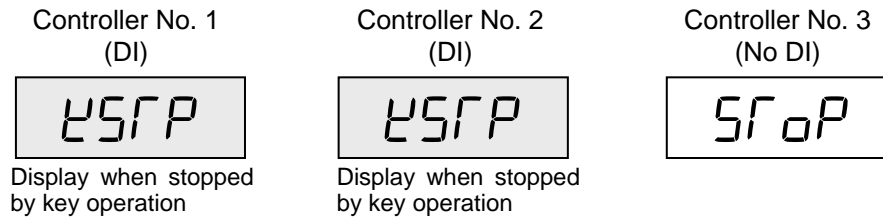

2. If any one of controller No. 1 to 3 is placed into the RUN state by key operation, all the controllers in that group enter the RUN state.

### ● Example 2: RUN/STOP by DI

[When controller No. 1 has DI]

(Controller No. 2, 3: May have or not have DI)

1. When controller No. 1 to 3 are in the RUN state, if the Digital input (DI) of controller No. 1 is transferred to the STOP state (contact closed → contact open), all the controllers in that group enter the STOP state.

STOP display at control STOP

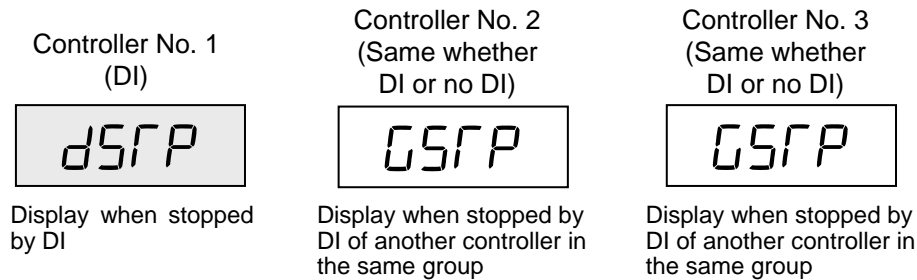

When stopped by DI, that group does not enter the RUN state as long as the operated DI is not set to RUN. Therefore, the STOP display is changed so that the controller that operated DI is known.

2. When the Digital input (DI) of controller No. 1 is transferred to the RUN state (contact open → contact closed), all the controllers of the same group enter the RUN state.



**When performing group RUN/STOP transfer by Digital input (DI), wiring conservation and simple operation are possible by setting “RUN/STOP transfer by Digital input (DI)” for only one controller in the group.**



When RUN/STOP by key operation and RUN/STOP by DI overlapped, the following occurs.

[When stopped by DI after STOP by key operation]

- Thereafter, when the Digital input (DI) of controller No. 1 is transferred to STOP, the STOP display changes while the STOP state remains unchanged. (When only controller No. 1 has DI)

STOP display at control STOP

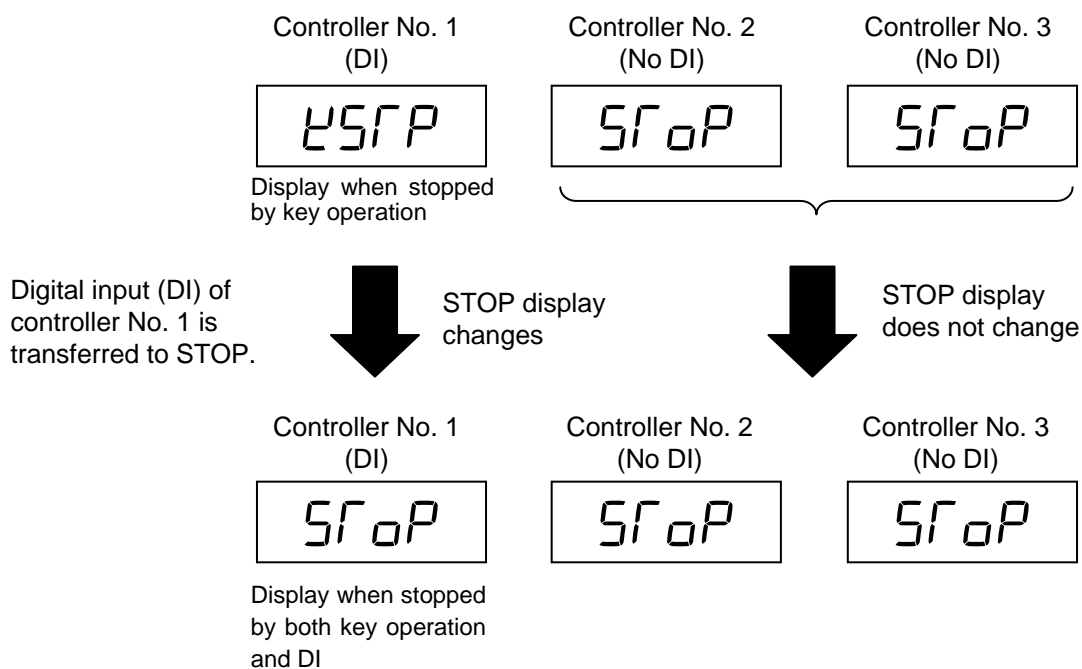

- To transfer from this state to the RUN state, the following operations are necessary.
  - The Digital input (DI) of controller No. 1 is transferred to the RUN state. (Contact open → Contact closed)
  - Any one of controller No.1 to 3 is set to the RUN state by key operation.

### 6.14.4 Automatic temperature rise function (with learning function)

The Automatic temperature rise function makes multiple controllers one group and synchronizes the temperature rise of the other controllers with the temperature rise of the controller in the same group which takes the longest time for the Measured value (PV) to reach the Set value (SV).

By using the Automatic temperature rise function to balance the temperature rise, uniform temperature control without any local burning or partial thermal expansion of the controlled system is possible.

Also, if started by turning on the Automatic temperature rise learning function (P. 6-78), the data needed by automatic temperature rise can be automatically computed and automatic temperature rise is possible from the next starting.



**Since Intercontroller communication has a time lag (maximum 70 ms × number of controllers connected) in data transmission, when using it in a fast response control system, take this time lag into consideration.**



The maximum number of connectable controllers at Intercontroller communication is 32, without regard to the number of groups.



When the group RUN/STOP function is used at automatic temperature rise by Intercontroller communication, all the controllers in the group can start temperature rise simultaneously.

Example: Multipoint temperature control using 4 controllers

- When controller No. 1 to 4 are started without Automatic temperature rise function, the Measured values (PV) individually rise toward the respective Set value (SV1 to 4). As a result, the temperature rise complete timings are also different.
- When controller No. 1 to 4 are made the same group, when the controllers are started using the Automatic temperature rise function after Automatic temperature rise teaching was executed, the temperature rise of controller No. 1 to 3 (slave) is synchronized to the temperature rise of controller No. 4 (master) which takes the longest time of any controller in the group for the Measured value (PV) to reach the Set value (SV). As a result, controller No. 1 to 4 complete temperature rise simultaneously.

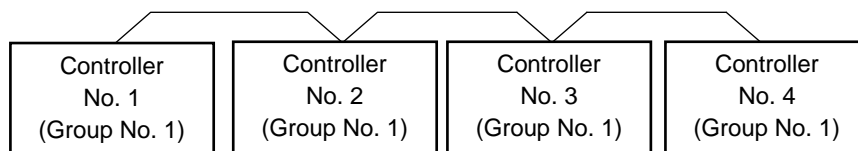

Connection status of the Intercontroller communication

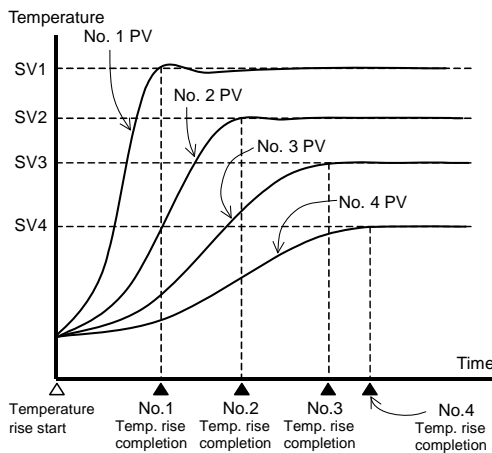

When automatic temperature rise not executed

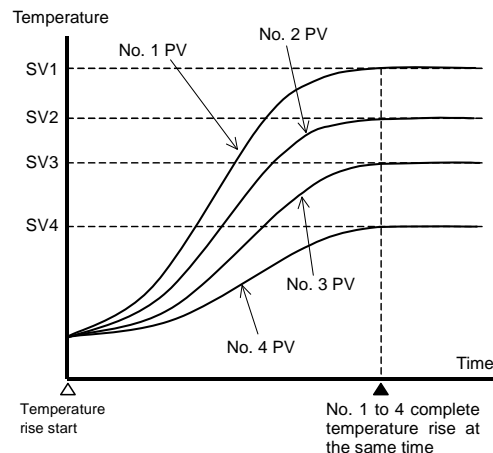

When automatic temperature rise executed

### ■ Requirements for Automatic temperature rise learning start

Automatic temperature rise learning can be executed when all the following conditions are satisfied.

Operation mode state	RUN/STOP transfer	RUN
	PID/AT transfer	PID control
	Auto/Manual transfer	Auto mode
	Remote/Local transfer	Local mode
Parameter setting	Automatic temperature rise group	Other than 0
	Automatic temperature rise learning	on (Learning)
	Output limiter value	Output limiter high $\geq 0.1\%$ , Output limiter low $\leq 99.9\%$
Input value state	The Measured value (PV) is not underscale or over-scale.	
	Input error determination point (high) $\geq$ Measured value (PV) $\geq$ Input error determination point (low)	
	The measured value (PV) is stable.	
	Set value (SV) $>$ Measured value (PV) [Heat/Cool PID control]	
Output value state	At startup, output is changed and saturated at the Output limiter high or the Output limiter low. *	

\* When the Setting change rate limiter is enabled, there is a concern that the output state when Automatic temperature rise learning is started will not saturate to the output limiter. In this case, the start condition for Automatic temperature rise learning cannot be met.



When starting Automatic temperature rise learning, start with a temperature difference between the Measured value (PV) and Set value (SV) of more than twice the proportional band.

### ■ Requirements for Automatic temperature rise learning cancellation

If any of the following states occur, Automatic temperature rise learning is immediately stopped. In this case, Automatic temperature rise learning remains set to “on (Learning).”

When the parameter is changed	The Automatic temperature rise learning setting is changed to “oFF (Unused).”
	When the PV bias, the PV digital filter, or the PV ratio is changed.
When the Operation mode is transferred	When the RUN/STOP mode is changed to the STOP mode.
	When the Auto/Manual mode is changed to the Manual mode.
	When the Remote/Local mode is changed to the Remote mode.
When the input value becomes abnormal	When the Measured value (PV) goes to underscale or over-scale.
	When the Measured value (PV) goes to input error range. (Measured value (PV) $\geq$ Input error determination point (high) or Input error determination point (low) Measured value (PV))
The execution time for Automatic temperature rise learning is exceeded.	Automatic temperature rise learning does not end after approximately 100 minutes has elapsed following the start of Automatic temperature rise learning.
Power failure	When the power failure of more than 20 ms occurs.
Instrument error	When the instrument is in the FAIL state.

### ■ Requirements for Automatic temperature rise start

When all the controllers in a group satisfy the following conditions, Automatic temperature rise is executed.

Operation mode state	RUN/STOP transfer	RUN <sup>1</sup>
	PID/AT transfer	PID control
	Auto/Manual transfer	Auto mode
Parameter setting	Control action	PID control (reverse action or direct action) Heat/Cool PID control (air cooling, water cooling, cooling gain linear type) <sup>2</sup>
	Automatic temperature rise group	Other than 0
	Automatic temperature rise learning	oFF (Unused)
Input value state		The Measured value (PV) is not underscale or over-scale.
		No burn out (input break or short circuit)
		Input error determination point (high) $\geq$ Measured value (PV) $\geq$ Input error determination point (low)
		Reverse action and Heat/Cool PID control (air cooling, water cooling, cooling gain linear type) <sup>2</sup> : Set value (SV) > Measured value (PV) at start of automatic temperature rise Direct action: Set value (SV) < Measured value (PV) at start of automatic temperature rise

<sup>1</sup> [RUN] (in RUN/STOP transfer) is absolute requirements for automatic temperature rise. The automatic temperature rise function is suspended if any one controller in the group does not satisfy this requirement. As soon as this requirement is satisfied, the automatic temperature rise is started.

If condition other than [RUN] is not satisfied, the controller where the condition is not matched is disabled for the automatic temperature rise, and the automatic temperature rise is executed in other controllers.

<sup>2</sup> When in Heat/Cool PID control, an automatic temperature rise only in the temperature rise direction is enabled.



Automatic temperature rise and Startup tuning (ST) can be executed simultaneously.

### ■ Requirements for Automatic temperature rise cancellation

When an abort condition is established for the master:

Automatic temperature rise of all the controllers in the group immediately stops and switches to normal control.

When an abort condition is established for the slaves:

The automatic temperature rise is aborted at the controller where the abort condition is established and normal control is started. Other controllers continue the automatic temperature rise.



When the automatic temperature rise is started, the controller which takes the longest time for the Measured value (PV) to reach the Set value (SV) of all the controllers in the group automatically becomes the master.

Operation mode state	RUN/STOP transfer	When the RUN/STOP mode is changed to the STOP mode.
	PID/AT transfer	When the Autotuning (AT) is activated.
	Auto/Manual transfer	When the Auto/Manual mode is changed to the Manual mode.
Parameter setting		When the proportional band is set to 0. (When the control type is changed to ON/OFF control)
Input value state		When the Measured value (PV) goes to underscale or over-scale.
		When the burnout occurs (input break or short circuit)
		When the Measured value (PV) goes to input error range. (Measured value (PV) $\geq$ Input error determination point (high) or Input error determination point (low) $\geq$ Measured value (PV))
Communication		When an Intercontroller communication error is generated
Power failure		When the power failure of more than 20 ms occurs.
Instrument error		When the instrument is in the FAIL state.

### ■ Operation flowchart

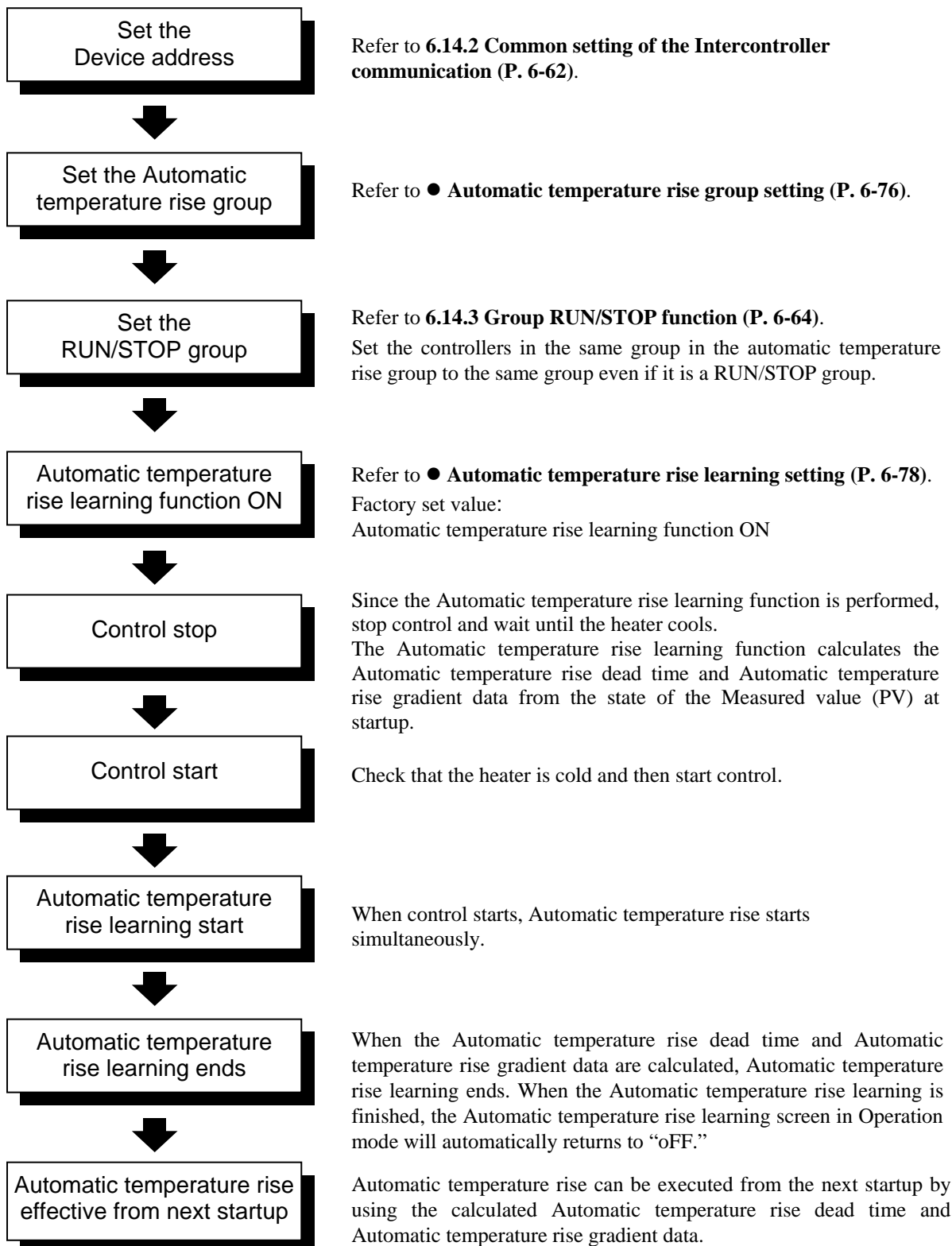

When in Heat/Cool PID control, automatic temperature rise learning and Automatic temperature rise are only in the temperature rise direction.

## ■ Settings before operation

When implementing the Automatic temperature rise function, the following items must be set.

- Device address [Setup setting mode]
  - Automatic temperature rise group [Engineering mode: Function block 55]
  - RUN/STOP group [Engineering mode: Function block 55]
  - Automatic temperature rise learning [Operation mode]
- ☞ For the Device address setting, refer to **6.14.2 Common setting of the Intercontroller communication (P. 6-62)**.
- ☞ For the RUN/STOP group setting, refer to **6.14.3 Group RUN/STOP function (P. 6-64)**.

## ● Automatic temperature rise group setting

Set the number of the group which performs Automatic temperature rise for each controller.

1. Change the Operation mode from RUN mode to STOP mode.

☞ To change from RUN mode to STOP mode, refer to **6.4 RUN/STOP Transfer (P. 6-11)**.

2. Press the Shift key while pressing the SET key for 2 seconds at PV/SV monitor screen until Engineering mode is displayed. Function block 10 screen is displayed first.

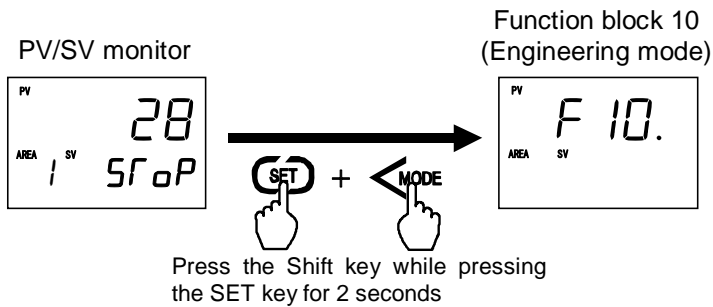

3. Press the UP key or DOWN key until Function block 55 screen is displayed.

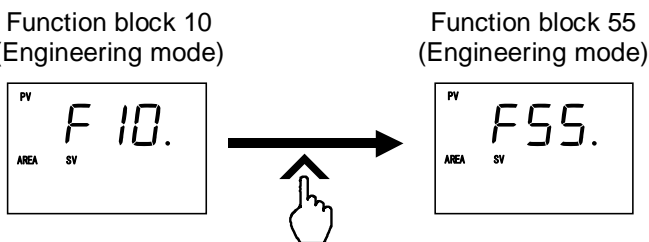

4. Press the SET key until Automatic temperature rise group screen is displayed.

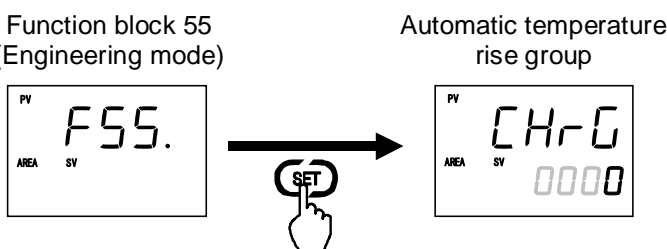





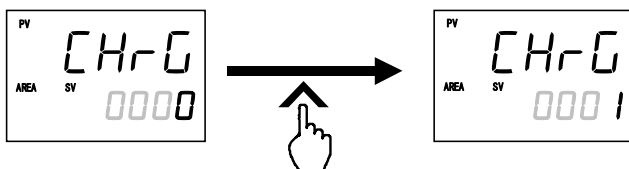

5. Select the Automatic temperature rise group number which needs to be changed by pressing the UP or DOWN key.

Setting range: 0 to 16 (Factory set value: 0)

Automatic temperature  
rise group



-  Set the controllers in the same group in the Automatic temperature rise group to the same group even if it is a RUN/STOP group.
-  When the group number is set to “0,” that controller does not perform Automatic temperature rise.
-  After a new value is displayed on the display by using UP and DOWN keys, if no key operation is performed within 1 minute without pressing SET key, this instrument returns to the PV/SV monitor screen and the Automatic temperature rise group number will not be changed.

6. Press the SET key to store the new Automatic temperature rise group number. The screen goes to the next parameter.

Automatic temperature  
rise group

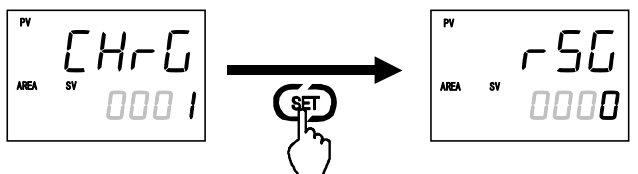

-  RUN/STOP group setting is possible in this state. For details, refer to **6.14.3 Group RUN/STOP function (P. 6-64)**.

7. To return the PV/SV monitor, press the Shift key while pressing the SET key.
8. Set the Automatic temperature rise group number of the other controllers by the same procedures as described in steps 1 to 7 above.

### ● Automatic temperature rise learning setting

Set the Automatic temperature rise leaning function ON/OFF for each controller.

1. Press and hold the SET key for 2 seconds at PV/SV monitor screen until Operation mode is displayed. PID/AT transfer screen is displayed first.

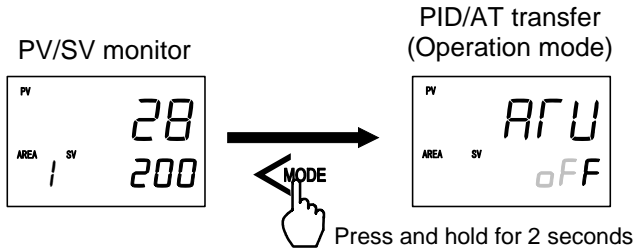

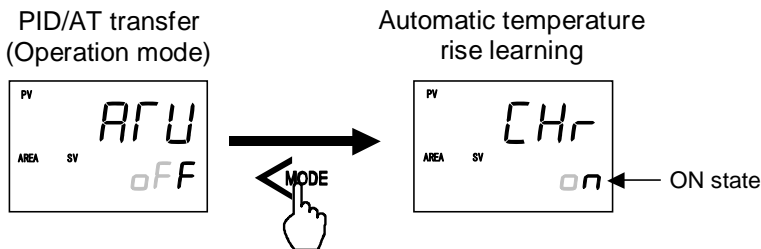

2. Press the Shift key until Automatic temperature rise learning screen is displayed.

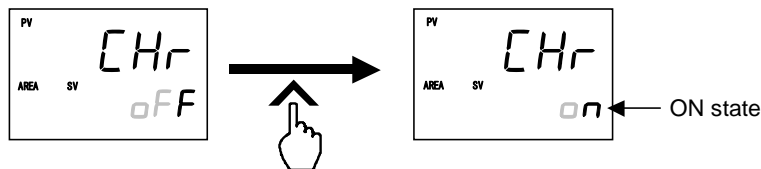

3. When the UP key is pressed, it switches from "oFF" to "on." In addition, since the shipping value is "on," when executing Automatic temperature rise leaning, it can be used as is.

Automatic temperature  
rise learning



 Press the DOWN key to change to "oFF" from "on."

 After a new value is displayed on the display by using UP and DOWN keys, if no key operation is performed within 1 minute without pressing SET key, this instrument returns to the PV/SV monitor screen and the Automatic temperature rise leaning ON/OFF will not be changed.

4. Press the Shift key or the SET key to store the new Automatic temperature rise learning ON/OFF data. The screen goes to the next parameter.

Automatic temperature  
rise learning

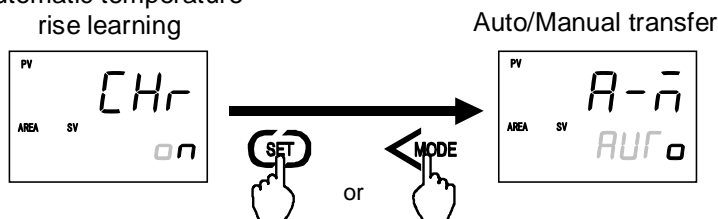

5. To return the PV/SV monitor, press the Shift key while pressing the SET key.

6. Set the Automatic temperature rise learning of the other controllers by the same procedures as described in steps 1 to 5 above.

## ■ Operation procedures

### ● When using the learning function

When using the learning function, the data (Automatic temperature rise dead time, Automatic temperature rise gradient data, etc.) necessary at Automatic temperature rise is automatically computed. Learning is implemented at controller startup.

#### 1. Set the Device address for each controller.

 For the Device address setting, refer to **6.14.2 Common setting of the Intercontroller communication (P. 6-62)**.

#### 2. Set the Automatic temperature rise group number for each controller and set the Automatic temperature rise function to ON in advance. In addition, set the RUN/STOP group for performing the group RUN/STOP function. Set the controllers in the same group in the Automatic temperature rise group to the same group even if it is a RUN/STOP group.

 For the Automatic temperature rise group number and Automatic temperature rise learning function setting, refer to **■ Settings before operation (P. 6-76)**.

 For the RUN/STOP group setting, refer to **6.14.3 Group RUN/STOP function (P. 6-64)**.

#### 3. Set control to the STOP state, and wait until the heater cools.

Since the Automatic temperature rise learning function computes the Automatic temperature rise dead time and Automatic temperature rise gradient data from the state of the Measured value (PV) at startup, the heater must be placed in the cold state once.

RUN/STOP transfer

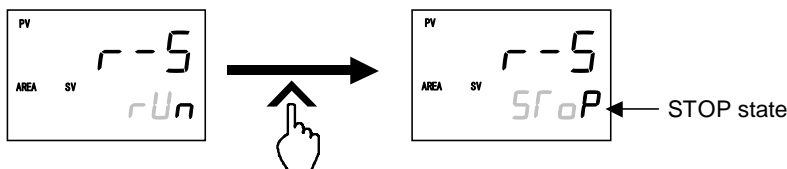

 For the RUN/STOP transfer, refer to **6.4 RUN/STOP Transfer (P. 6-11)**.  
For the group RUN/STOP, refer to **6.14.3 Group RUN/STOP function (P. 6-64)**.

#### 4. When control is set to the RUN state after it is confirmed that the heater is cold, Automatic temperature rise learning is started.

RUN/STOP transfer

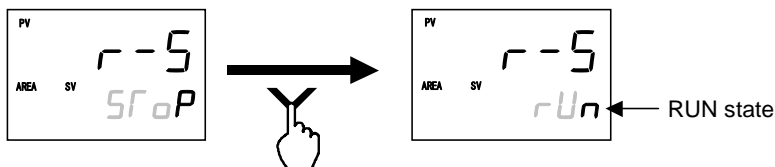

 For the RUN/STOP transfer, refer to **6.4 RUN/STOP Transfer (P. 6-11)**.  
For the group RUN/STOP, refer to **6.14.3 Group RUN/STOP function (P. 6-64)**.

5. When the Automatic temperature rise dead time and Automatic temperature rise gradient data are computed, Automatic temperature rise learning ends.

When the Automatic temperature rise learning is finished, the Automatic temperature rise learning screen in Operation mode will automatically returns to “oFF.”

Automatic temperature  
rise learning

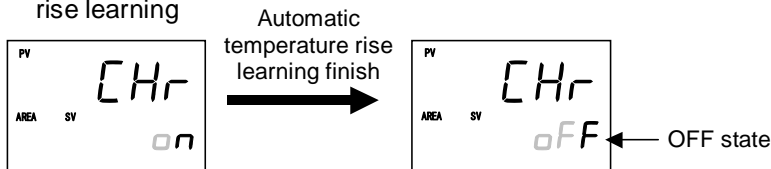

**At this point, the data necessary at Automatic temperature rise is only collected. Automatic temperature rise is not yet executed. Automatic temperature rise can be executed from the next startup.**



When the Automatic temperature rise group and other set values were changed, execute Automatic temperature rise learning again.



Automatic temperature rise learning can be performed for each controller. It can also be performed by group batch by using the group RUN/STOP function.



When Automatic temperature rise learning is not established, the operation mode Automatic temperature rise learning screen remains “on.”

● **When performing Automatic temperature rise (when ending the learning function)**

1. When the controllers of the Automatic temperature rise group are set to RUN simultaneously, Automatic temperature rise starts. Automatic temperature rise is executed by controllers other than Automatic temperature rise group number “0.”



To RUN the controllers of the Automatic temperature rise group simultaneously, use the group RUN/STOP function. For the group RUN/STOP, refer to **6.14.3 Group RUN/STOP function (P. 6-64)**.

2. The other controllers perform temperature rise in synchronization with the temperature rise of the controller which takes the longest for the Measured value (PV) to reach the Set value (SV) in the same group. The controllers in the same group complete temperature rise simultaneously.



When you do not want to execute Automatic temperature rise, set the Automatic temperature rise group number of the relevant controller to “0.”

### 6.14.5 Cascade control function

Cascade control monitors the controlled object temperature in the master unit and then corrects the set value in the slave unit depending on the deviation between the target value (set value) and actual temperature. The slave unit controls the non-controlled object (heater, refrigeration device, etc). As a result, the controlled object temperature can be reached and controlled at the target value.

At Cascade control that uses Intercontroller communication, one of the connected controllers is specified the master and the other arbitrary controllers are controlled as slaves.

 Since Intercontroller communication has a time lag (maximum 70 ms × number of controllers connected) in data transmission, when using it in a fast response control system, take this time lag into consideration.  
[The Slave set value (remote SV) is updated at each time lag.]

 The Cascade control slave controllers cannot use remote setting input.

 The maximum number of combined master and slave controllers connectable at Intercontroller communication is 32.

Example: When using 3 controllers and controlling extruders in cascade

Specify one controller as the master and use the remaining two controllers as slaves. The Master manipulated output (MV) becomes the Slave set value (SV).

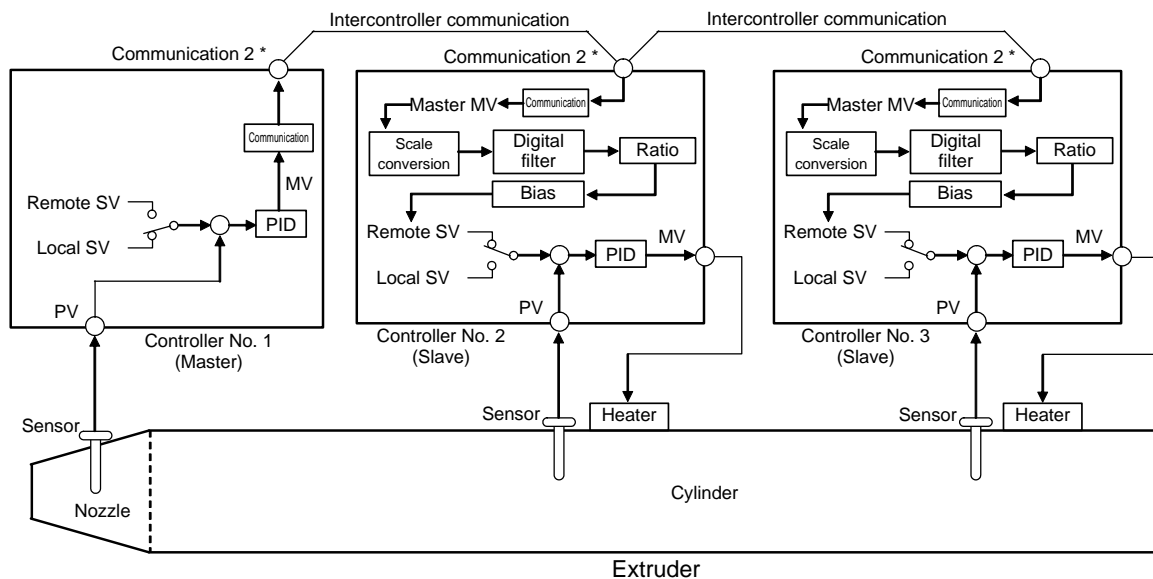
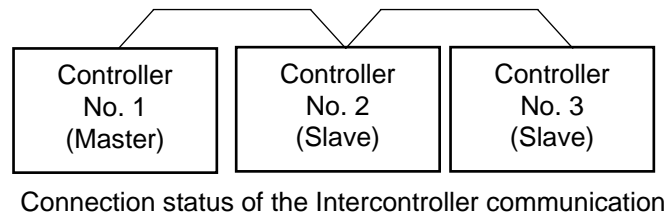

\* "Communication 1" when one-point communication is used on the FB100.

Block diagram of Cascade control by Intercontroller communication

■ **Operation flowchart**

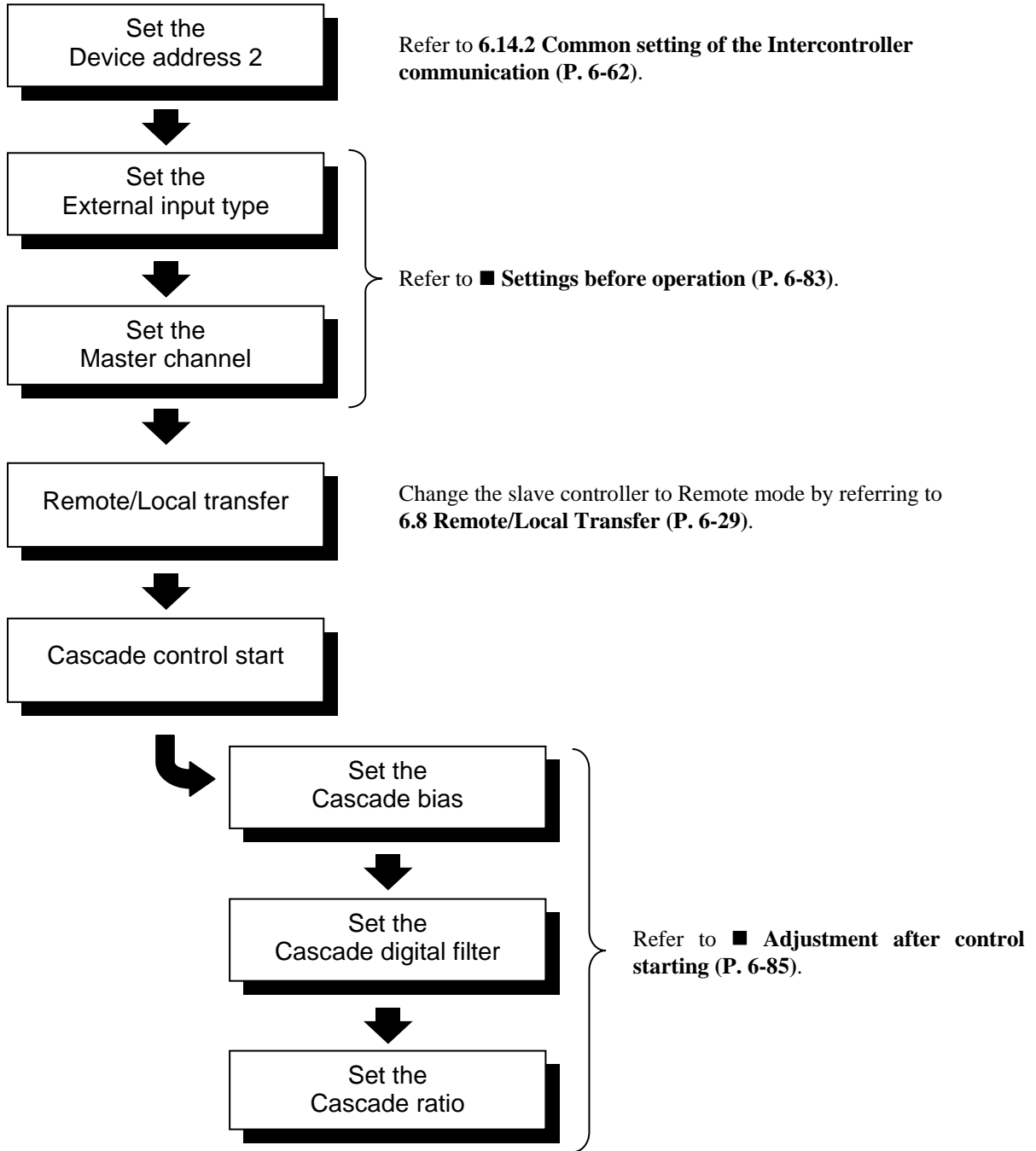

## ■ Settings before operation

When implementing the Cascade control, the following items must be set.

- Device address [Setup setting mode]
- External input type [Engineering mode: Function block 50]
- Master channel selection [Engineering mode: Function block 50]

 For the Device address setting, refer to **6.14.2 Common setting of the Intercontroller communication (P. 6-62)**.

### ● Set the External input type and Master channel selection

Set the External input type for each controller. In addition, select the controller which is to become the Cascade control master.

1. Change the operation mode from RUN mode to STOP mode.

 To change from RUN mode to STOP mode, refer to **6.4 RUN/STOP Transfer (P. 6-11)**.

2. Press the Shift key while pressing the SET key for 2 seconds at PV/SV monitor screen until Engineering mode is displayed. Function block 10 screen is displayed first.

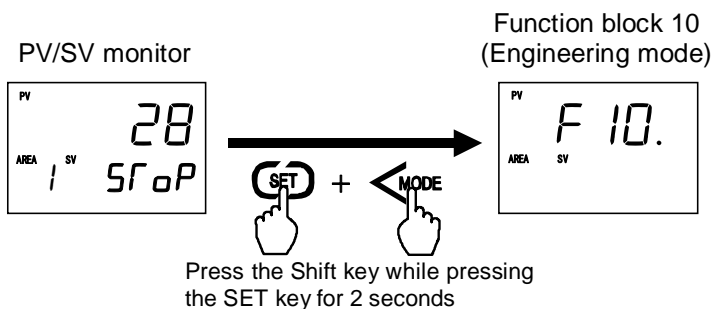

3. Press the UP key or DOWN key until Function block 50 screen is displayed.

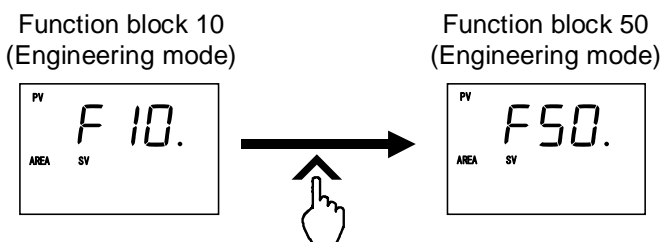

4. Press the SET key until External input type setting screen is displayed.

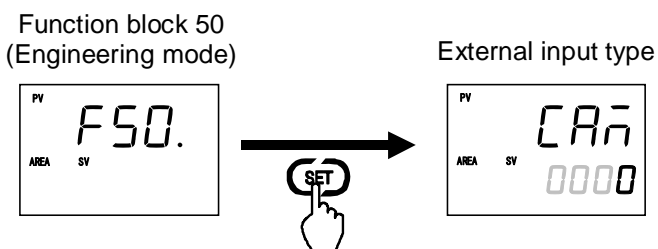

5. Select the External input type which needs to be changed by pressing the UP or DOWN key.  
Set "0" to the master controller and "1" to the slave controller.

Setting range: 0: Remote setting (RS) input  
1: Intercontroller communication cascade control  
2: Intercontroller communication ratio setting  
(Factory set value: 0)

External input type

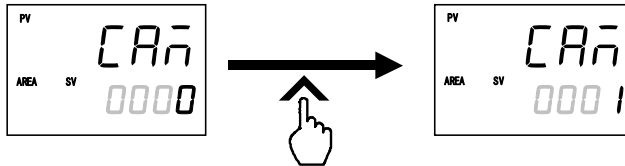

After a new value is displayed on the display by using UP and DOWN keys, if no key operation is performed within 1 minute without pressing SET key, this instrument returns to the PV/SV monitor screen and the External input type will not be changed.

6. Press the SET key to store the new External input type. The screen goes to the Master channel selection screen.

External input type

Master channel selection

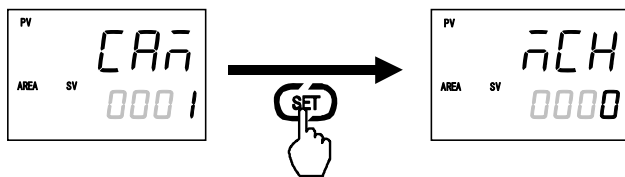

7. Press the UP key or DOWN key and set the address (value set by the Device address screen) of the controller specified the cascade control master. Set the Master channel to only the slave controller. No setting of the master controller is required.

Setting range: 0 to 31 (Factory set value: 0)

Master channel selection

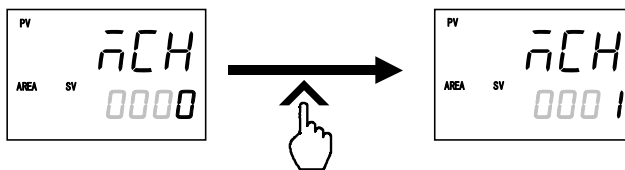

After a new value is displayed on the display by using UP and DOWN keys, if no key operation is performed within 1 minute without pressing SET key, this instrument returns to the PV/SV monitor screen and the Master channel will not be changed.

8. Press the SET key to store the new Master channel. The screen goes to the next parameter.

Master channel selection

SV tracking

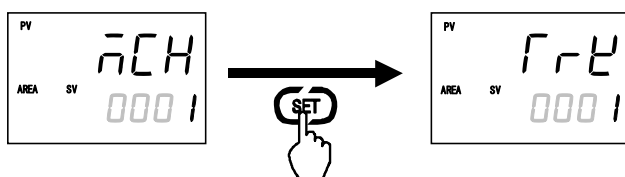



9. To return the PV/SV monitor, press the Shift key while pressing the SET key.

10. Set the External input type and Master channel selection of the other controllers by the same procedures as described in steps 1 to 9 above.

## ■ Adjustment after control starting

### ● Set the Cascade bias, Cascade digital filter and Cascade ratio

Set the bias, digital filter, and ratio at each controller for the setting input (master MV) from the master. Set these according to the actual operation state.



When the controller selected as the master was placed into the Remote mode, the RS bias, RS digital filter, and RS ratio can be set.



The relationship between master MV and slave SV by slave Cascade ratio and Cascade bias is shown by the example below.

Example: When the output scale of master is 0 to 100 % and the input scale of slave is  $-100$  to  $+400$  °C

- Cascade ratio (slave): 1.000, Cascade bias (slave): 0 °C  
Slave input scale for master output scale 0 to 100 % is  $-100$  to  $+400$  °C
- Cascade ratio (slave): 0.500, Cascade bias (slave): 100 °C  
Slave input scale for master output scale 0 to 100 % is 50 to 300 °C

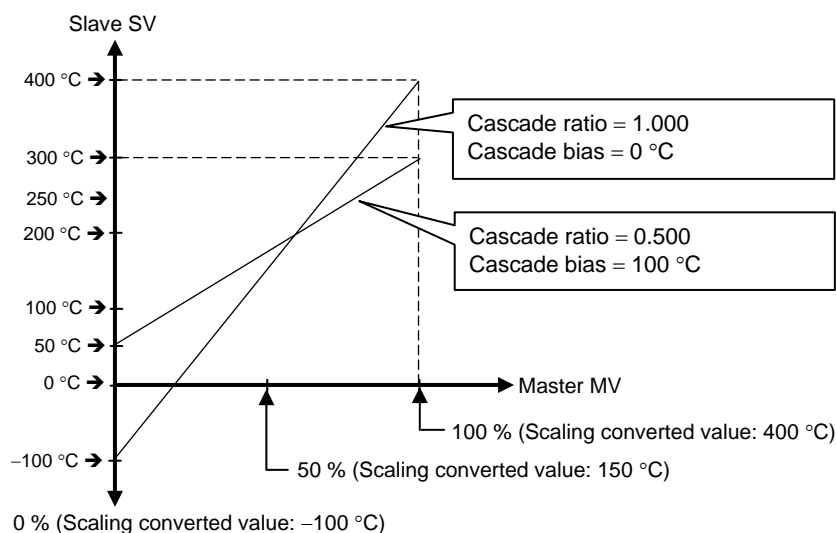

1. Press the Shift key while pressing the SET key at PV/SV monitor screen until Setup setting mode is displayed. The screen displayed first differs depending on the specification.

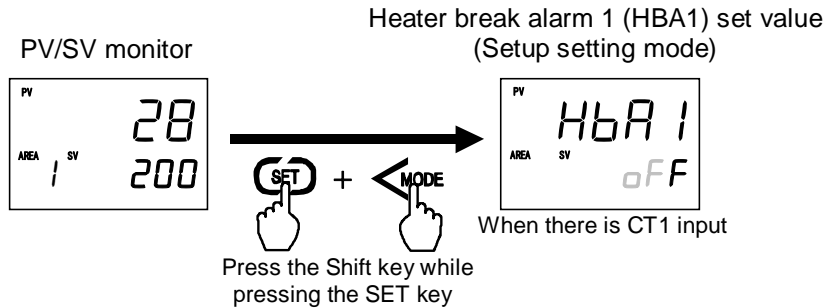

2. Press the SET key until Cascade bias screen is displayed.  
Press the Shift key, UP key, or DOWN key and set the bias for the setting input (master MV) from the master.

Setting range: -Input span to +Input span (Factory set value: 0)

Cascade bias (RS bias)



If the External input type is Remote setting input, the Cascade bias screen becomes the RS bias screen and if Intercontroller communication ratio setting, it becomes the Ratio setting bias screen. In other places, this is indicated as “RS bias.”



After a new value is displayed on the display by using UP and DOWN keys, if no key operation is performed within 1 minute without pressing SET key, this instrument returns to the PV/SV monitor screen and the Cascade bias will not be changed.

3. Press the SET key to store the new Cascade bias. The screen goes to the Cascade digital filter screen. Press the Shift key, UP key, or DOWN key and set the digital filter for the setting input (master MV) from the master.

Setting range: 0.1 to 100.0 seconds

oFF: Unused (Factory set value: oFF)

Cascade digital filter (RS digital filter)



If the External input type is Remote setting input, the Cascade digital filter screen becomes the RS digital filter screen and if Intercontroller communication ratio setting, it becomes the Ratio setting digital filter screen. In other places, this is indicated as “RS digital filter.”



After a new value is displayed on the display by using UP and DOWN keys, if no key operation is performed within 1 minute without pressing SET key, this instrument returns to the PV/SV monitor screen and the Cascade digital filter will not be changed.

- Press the SET key to store the new Cascade digital filter. The screen goes to the Cascade ratio screen. Press the Shift key, UP key, or DOWN key and set the ratio for the setting input (master MV) from the master.

Setting range: 0.001 to 9.999 (Factory set value: 1.000)

Cascade ratio  
(RS ratio)



If the External input type is Remote setting input, the Cascade ratio screen becomes the RS ratio screen and if Intercontroller communication ratio setting, it becomes the Ratio setting ratio screen. In other places, this is indicated as “RS ratio.”



After a new value is displayed on the display by using UP and DOWN keys, if no key operation is performed within 1 minute without pressing SET key, this instrument returns to the PV/SV monitor screen and the Cascade ratio will not be changed.

- Press the SET key to store the new Cascade ratio. The screen goes to the next parameter.

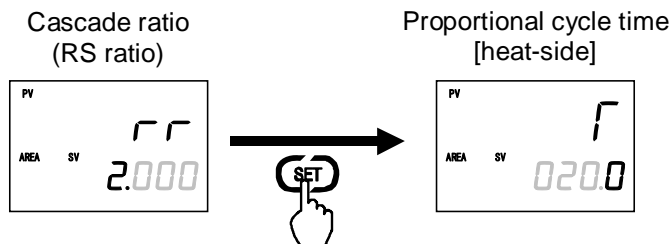

- To return the PV/SV monitor, press the Shift key while pressing the SET key.
- Set the Cascade bias, Cascade digital filter and Cascade ratio of the other slaves by the same procedures as described in steps 1 to 6 above.



For the setting procedure, refer to **5.2.2 Changing set value (SV) (P. 5-9)** or **6.3 Operating Setting (P. 6-5)**.

## ■ Operation procedures

1. Set the Device address for each controller.

 For the Device address setting, refer to **6.14.2 Common setting of the Intercontroller communication (P. 6-62)**.

2. Set the External input type for each controller.

Set “0: Remote setting (RS) input” to the master controller, and “1: Intercontroller communication cascade control” to the slave controller.

 For the External input type setting, refer to **■ Settings before operation (P. 6-83)**.

3. Set the master for the Cascade control.

Set the address (setting of the Device address) of the controller which becomes the master at the controllers which become the slaves. Setting is unnecessary for the master.

 For the Master channel setting, refer to **■ Settings before operation (P. 6-83)**.

4. Change the slave controller to remote mode. Cascade control by Intercontroller communication can be executed if the slave controllers are in the Remote mode.

Remote/Local transfer

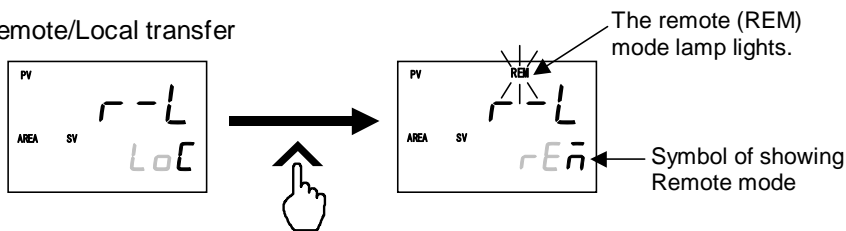

 To change from the Local mode to the Remote mode, refer to **6.8 Remote/Local Transfer (P. 6-29)**.

5. The settings above starts Cascade control by Intercontroller communication.

6. Perform Cascade bias, Cascade digital filter, and Cascade ratio adjustment which actually operating.

 For the Cascade bias, Cascade digital filter, and Cascade ratio, refer to **■ Adjustment after control starting (P. 6-85)**.

### 6.14.6 Ratio setting function

Ratio setting exercises control with the product of the Set value (SV) from the master multiplied by a fixed ratio as the slave Set value (SV)

 Since Intercontroller communication has a time lag (maximum 70 ms × number of controllers connected) in data transmission, when using it in a fast response control system, take this time lag into consideration.

[The slave set value (remote SV) is updated at each time lag.]

 The Ratio setting slave controllers cannot use remote setting input.

 The maximum number of combined master and slave controllers connectable at Intercontroller communication is 32.

Example: When using 3 controllers and setting extruders in ratio

Specify one controller as the master and use the remaining two controllers as slaves. The product of the master Set value (SV) multiplied by a fixed ratio becomes the slave Set value (SV).

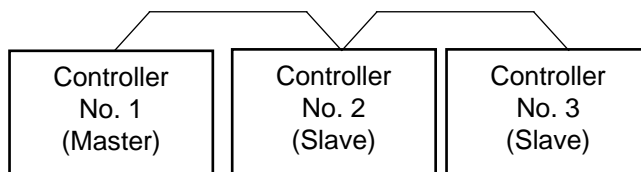

Connection status of the Intercontroller communication

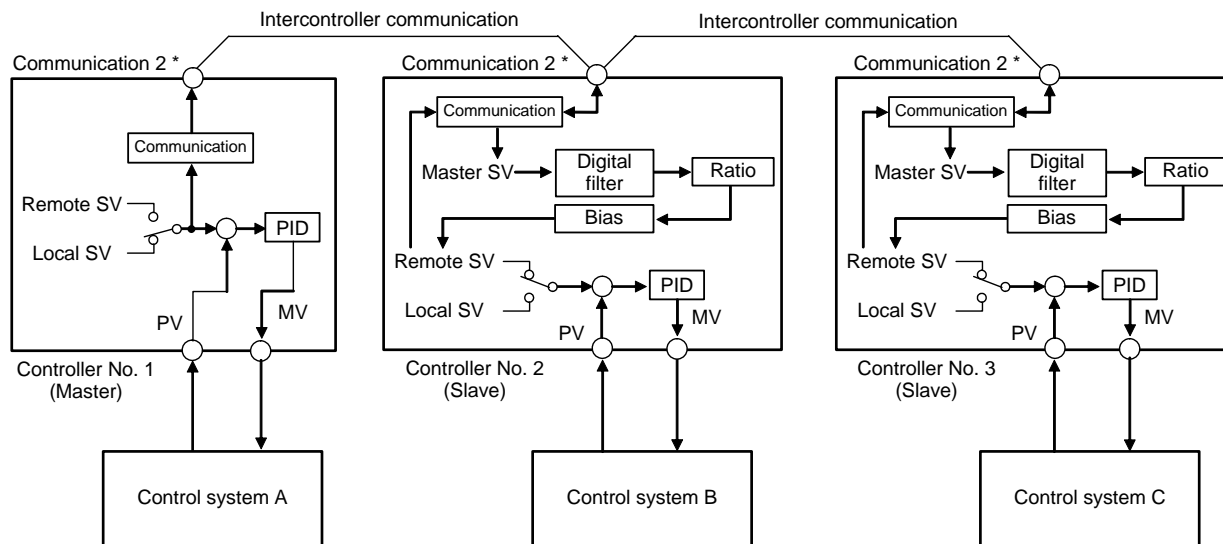

\* "Communication 1" when one-point communication is used on the FB100.

Block diagram of Ratio setting by Intercontroller communication

■ **Operation flowchart**

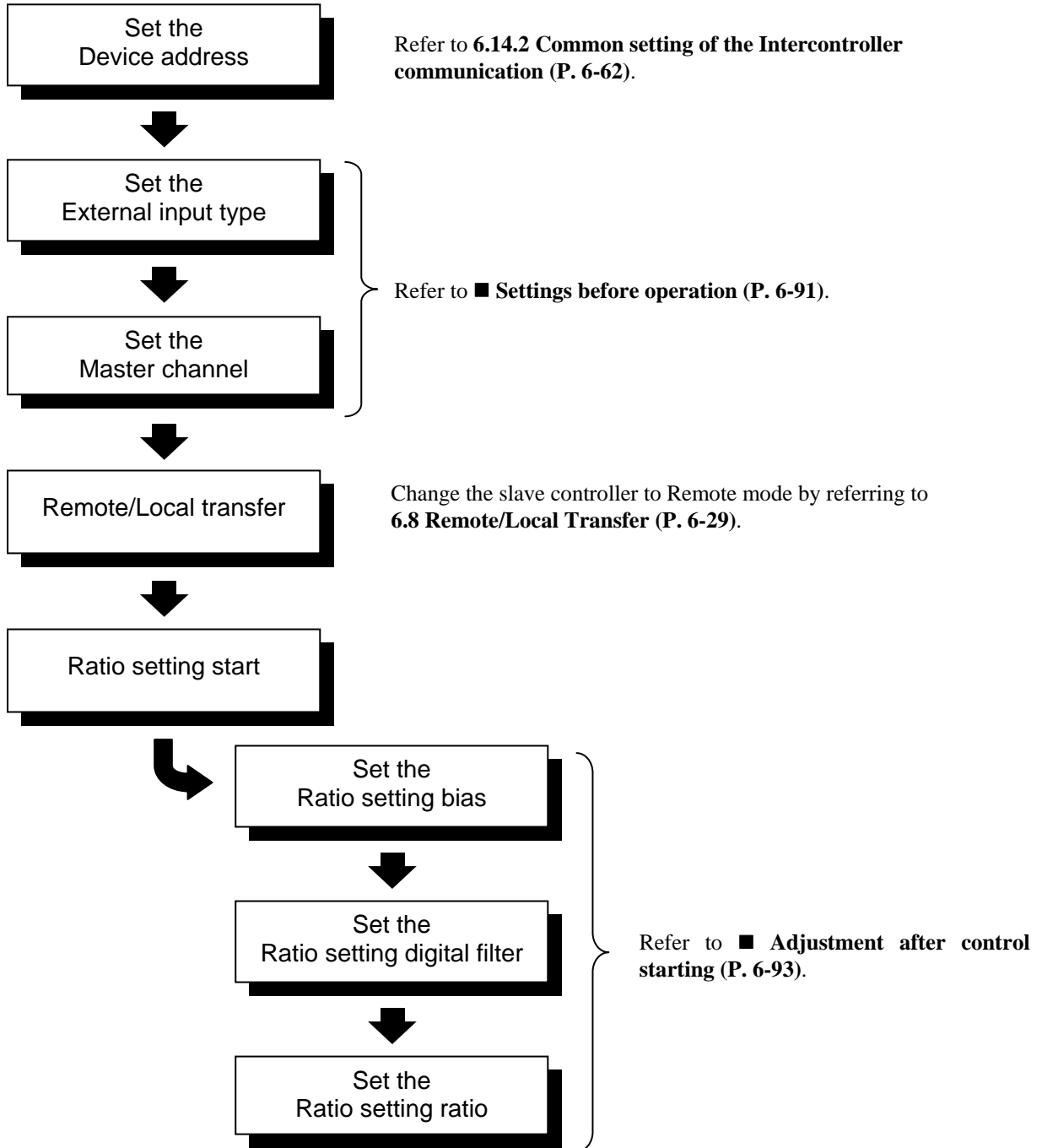

## ■ Settings before operation

When implementing the Ratio setting, the following items must be set.

- Device address [Setup setting mode]
- External input type [Engineering mode: Function block 50]
- Master channel selection [Engineering mode: Function block 50]

 For the Device address setting, refer to **6.14.2 Common setting of the Intercontroller communication (P. 6-62)**.

### ● Set the External input type and Master channel selection

Set the External input type for each controller. In addition, select the controller which is to become the Ratio setting master.

1. Change the Operation mode from RUN mode to STOP mode.

 To change from RUN mode to STOP mode, refer to **6.4 RUN/STOP Transfer (P. 6-11)**.

2. Press the Shift key while pressing the SET key for 2 seconds at PV/SV monitor screen until Engineering mode is displayed. Function block 10 screen is displayed first.

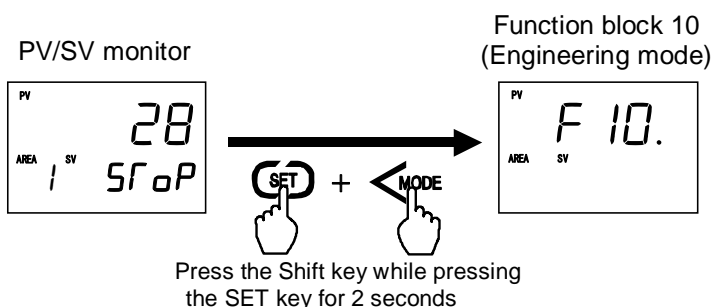

3. Press the UP key or DOWN key until Function block 50 screen is displayed.

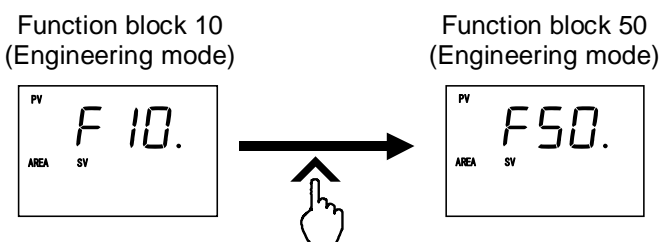

4. Press the SET key until External input type setting screen is displayed.

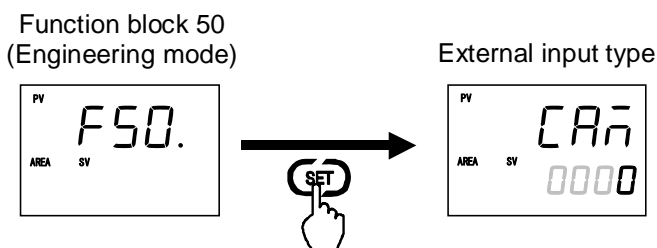

5. Select the External input type which needs to be changed by pressing the UP or DOWN key.  
Set "0" to the master controller and "2" to the slave controller.

Setting range: 0: Remote setting (RS) input

1: Intercontroller communication cascade control

2: Intercontroller communication ratio setting

(Factory set value: 0)

External input type

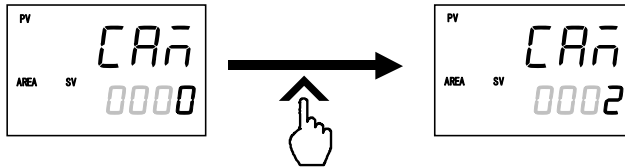

After a new value is displayed on the display by using UP and DOWN keys, if no key operation is performed within 1 minute without pressing SET key, this instrument returns to the PV/SV monitor screen and the External input type will not be changed.

6. Press the SET key to store the new External input type. The screen goes to Master channel selection screen.

External input type

Master channel selection

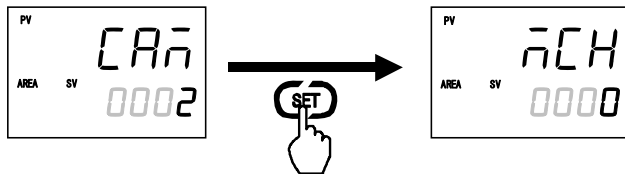

7. Press the UP key or DOWN key and set the address (value set by the Device address screen) of the controller specified the ratio setting master. Set the Master channel to only the slave controller. No setting of the master controller is required.

Setting range: 0 to 31 (Factory set value: 0)

Master channel selection

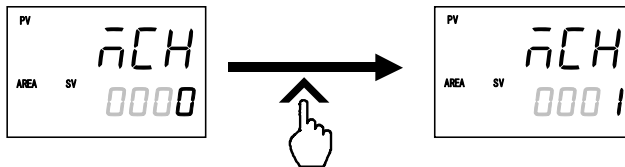

After a new value is displayed on the display by using UP and DOWN keys, if no key operation is performed within 1 minute without pressing SET key, this instrument returns to the PV/SV monitor screen and the Master channel will not be changed.

8. Press the SET key to store the new Master channel. The screen goes to the next parameter.

Master channel selection

SV tracking

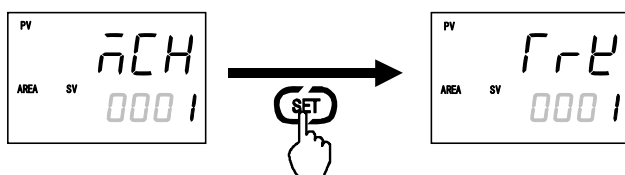





9. To return the PV/SV monitor, press the Shift key while pressing the SET key.
10. Set the External input type and Master channel selection of the other controllers by the same procedures as described in steps 1 to 9 above.

■ **Adjustment after control starting**

● **Set the Ratio setting bias, Ratio setting digital filter and Ratio setting ratio**

Set the bias, digital filter, and ratio at each controller for the setting input (master MV) from the master. Set these according to the actual operation state.

-  When the controller selected as the master was placed into the Remote mode, the RS bias, RS digital filter, and RS ratio can be set.
-  The relationship between master SV and slave SV by slave Ratio setting ratio and Ratio setting bias is shown by the example below.

Example: When the master and slave setting limiter range is 0 to 400 °C

- Ratio setting ratio (slave): 0.500, Ratio setting bias (slave): 20 °C  
Master set value (SV): 200 °C → Slave set value (SV): 120 °C
  - Ratio setting ratio (slave): 2.000, Ratio setting bias (slave): 100 °C  
Master set value (SV): 200 °C → Slave set value (SV): 400 °C \*
- \* According to the computed value, the Slave set value (SV) becomes 500 °C but since the Setting limiter range is 0 to 400 °C, the Slave set value (SV) becomes the Setting limiter high: 400 °C

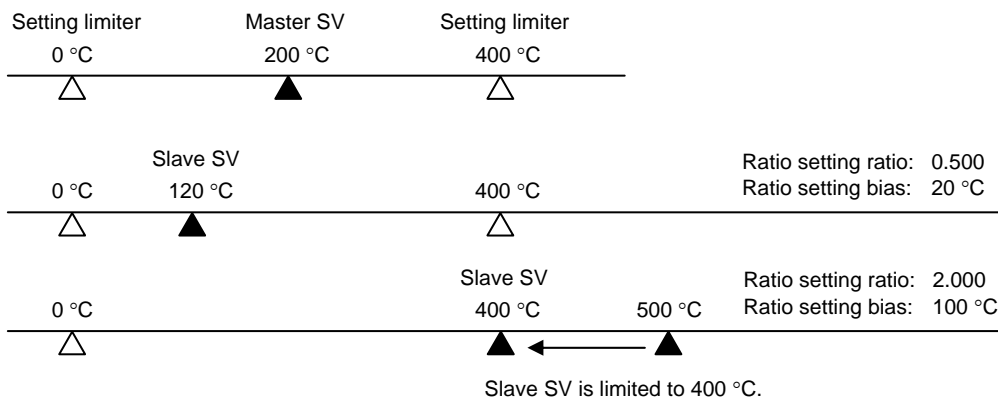

1. Press the Shift key while pressing the SET key at PV/SV monitor screen until Setup setting mode is displayed. The screen displayed first differs depending on the specification.

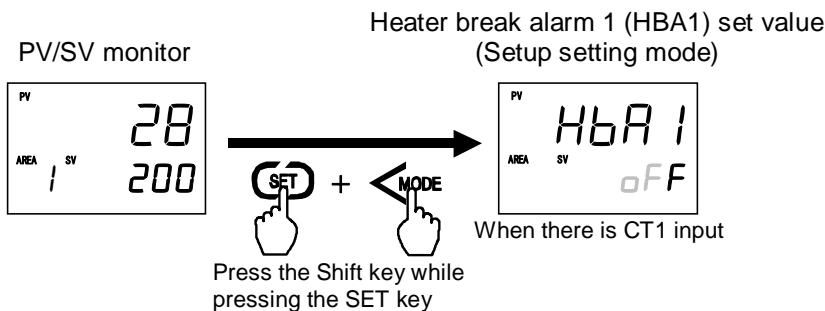

2. Press the SET key until Ratio setting bias screen is displayed.

Press the Shift key, UP key, or DOWN key and set the bias for the setting input (master SV) from the master.

Setting range: –Input span to +Input span (Factory set value: 0)

Ratio setting bias  
(RS bias)

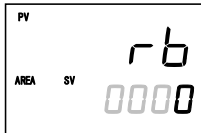

If the External input type is Remote setting input, the Ratio setting bias screen becomes the RS bias screen and if Intercontroller communication cascade control, it becomes the Cascade bias screen. In other places, this is indicated as “RS bias.”



After a new value is displayed on the display by using UP and DOWN keys, if no key operation is performed within 1 minute without pressing SET key, this instrument returns to the PV/SV monitor screen and the Ratio setting bias will not be changed.

3. Press the SET key to store the new Ratio setting bias. The screen goes to Ratio setting digital filter screen.

Press the Shift key, UP key, or DOWN key and set the digital filter for the setting input (master SV) from the master.

Setting range: 0.1 to 100.0 seconds

oFF: Unused (Factory set value: oFF)

Ratio setting digital filter  
(RS digital filter)



If the External input type is Remote setting input, the Ratio setting digital filter screen becomes the RS digital filter screen and if Intercontroller communication cascade control, it becomes the Cascade digital filter screen. In other places, this is indicated as “RS digital filter.”



After a new value is displayed on the display by using UP and DOWN keys, if no key operation is performed within 1 minute without pressing SET key, this instrument returns to the PV/SV monitor screen and the Ratio setting digital filter will not be changed.

4. Press the SET key to store the new Ratio setting digital filter. The screen goes to Ratio setting ratio screen.

Press the Shift key, UP key, or DOWN key and set the ratio for the setting input (master SV) from the master.

Setting range: 0.001 to 9.999 (Factory set value: 1.000)

Ratio setting ratio  
(RS ratio)



If the External input type is Remote setting input, the Ratio setting ratio screen becomes the RS ratio screen and if Intercontroller communication cascade control, it becomes the Cascade ratio screen. In other places, this is indicated as “RS ratio.”



After a new value is displayed on the display by using UP and DOWN keys, if no key operation is performed within 1 minute without pressing SET key, this instrument returns to the PV/SV monitor screen and the Ratio setting ratio will not be changed.

5. Press the SET key to store the new Ratio setting ratio. The screen goes to the next parameter.

Ratio setting ratio  
(RS ratio)

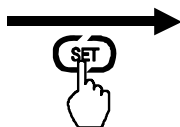

Proportional cycle time  
[heat-side]



6. To return the PV/SV monitor, press the Shift key while pressing the SET key.
7. Set the Ratio setting bias, Ratio setting digital filter and Ratio setting ratio of the other slaves by the same procedures as described in steps 1 to 6 above.



For the setting procedure, refer to **5.2.2 Changing set value (SV) (P. 5-9)** or **6.3 Operating setting (P. 6-5)**.

## ■ Operation procedures

1. Set the Device address for each controller.

☞ For the Device address setting, refer to **6.14.2 Common setting of the Intercontroller communication (P. 6-62)**.

2. Set the External input type for each controller.

Set “0: Remote setting (RS) input” to the master controller, and “2: Intercontroller communication ratio setting” to the slave controller.

☞ For the External input type setting, refer to **■ Settings before operation (P. 6-91)**.

3. Set the master for the ratio setting.

Set the address (setting of the Device address) of the controller which becomes the master at the controllers which become the slaves. Setting is unnecessary for the master.

☞ For the Master channel setting, refer to **■ Settings before operation (P. 6-91)**.

4. Change the slave controller to remote mode. Ratio setting by Intercontroller communication can be executed if the slave controllers are in the Remote mode.

Remote/Local transfer

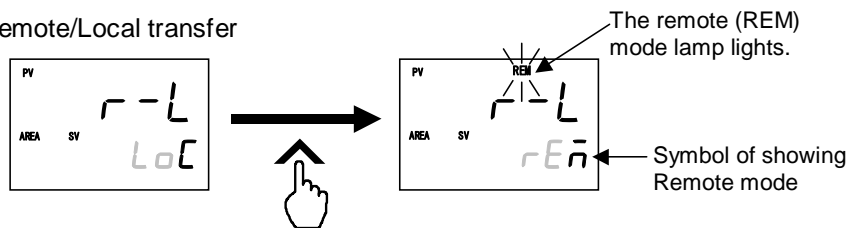

☞ To change from the Local mode to the Remote mode, refer to **6.8 Remote/Local Transfer (P. 6-29)**.

5. The settings above starts ratio setting by Intercontroller communication.
6. Perform Ratio setting bias, Ratio setting digital filter, and Ratio setting ratio adjustment which actually operating.

☞ For the Ratio setting bias, Ratio setting digital filter, and Ratio setting ratio, refer to **■ Adjustment after control starting (P. 6-93)**.

## ■ Usage example

### ● Example 1

Depending on the master channel setting, the following Master/Slave relationship can be established.

Controller No.	Device address	Set the Master channel	Master/Slave
1	0	—	Master — Slave — Slave/Master * — Slave — Slave — Slave
2	1	0	
3	2	0	
4	3	0	
5	4	2	
6	5	2	

\* Controller No. 3 becomes a controller number 1 slave and the master of controller No. 5 and No. 6.

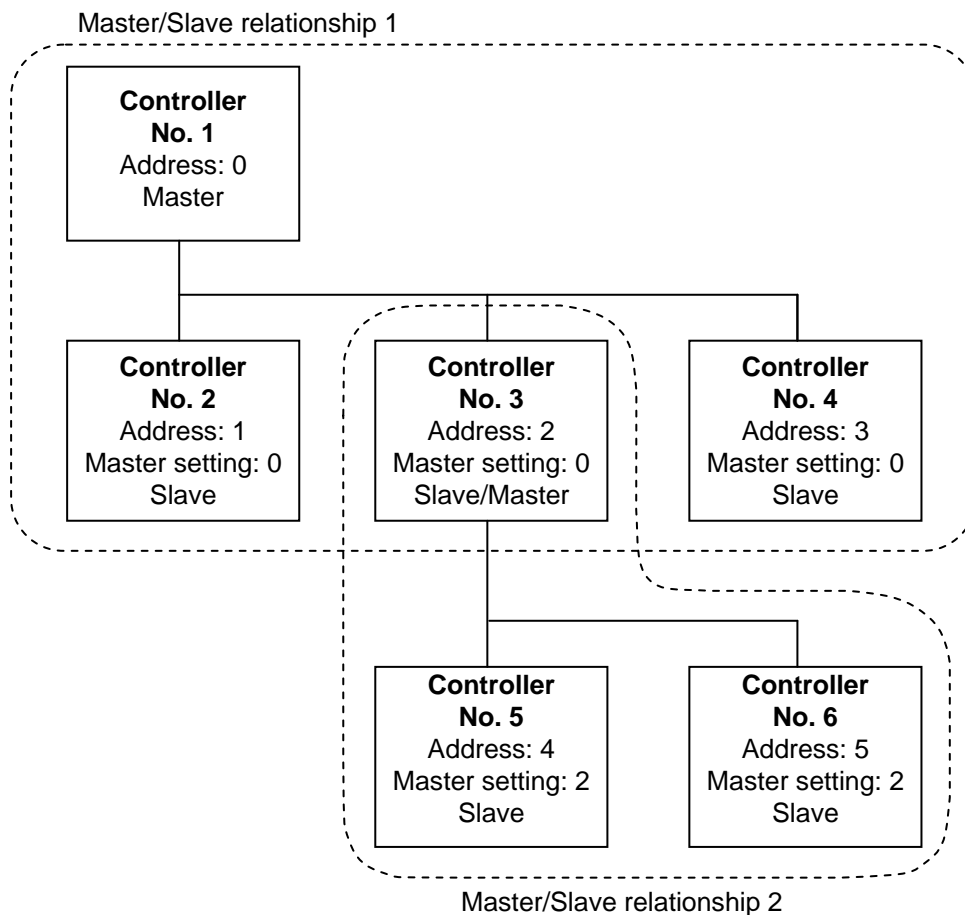

● **Example 2**

When ratio setting by Intercontroller communication by a connection like that shown below was performed, a difference in the master SV change and slave SV change is generated.

Input the program controller Set value (SV) to the ratio setting master by Intercontroller communication as Remote setting input.

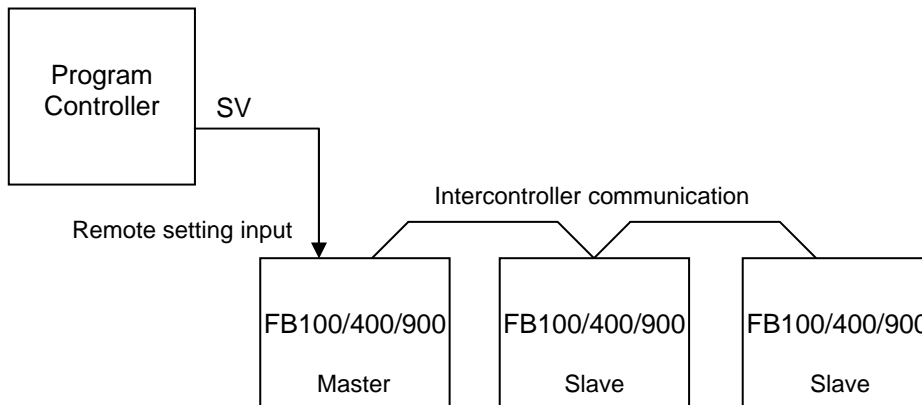

The master SV values continuously change gradually, the same as the program controller Set value (SV), but since there is a time lag due to Intercontroller communication, the slave SV changes in a stepped state.

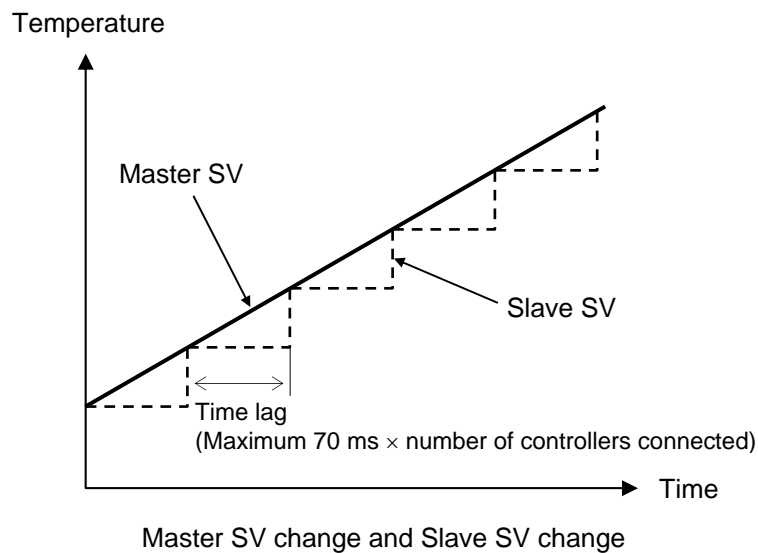

# PARAMETER DESCRIPTION



7.1 SV Setting & Monitor Mode .....	7-2
7.1.1 Display sequence (When the Direct key type is other than Monitor) ...	7-2
7.1.2 Display sequence (When the Direct key type is Monitor).....	7-3
7.1.3 Monitor and setting item.....	7-4
7.2 Operation Mode .....	7-14
7.2.1 Display sequence.....	7-14
7.2.2 Operation item.....	7-15
7.3 Parameter Setting Mode .....	7-22
7.3.1 Display sequence.....	7-23
7.3.2 Parameter setting item .....	7-24
7.4 Setup Setting Mode .....	7-37
7.4.1 Display sequence.....	7-37
7.4.2 Setup setting item .....	7-38
7.5 Engineering Mode.....	7-52
7.5.1 Display sequence.....	7-52
7.5.2 Precaution against parameter change .....	7-58
7.5.3 Engineering setting item.....	7-65

# 7.1 SV Setting & Monitor Mode

In SV setting & monitor mode, the following operations are possible.

- Change the Set value (SV)
- Change memory area
- Monitor the Measured value (PV) and the Manipulated output value (MV), etc.

The display sequence of SV setting & monitor mode display differs depending on the Direct key type (Monitor and except for Monitor). The Direct key type can be selected in Engineering mode.

## 7.1.1 Display sequence (When the Direct key type is other than Monitor)

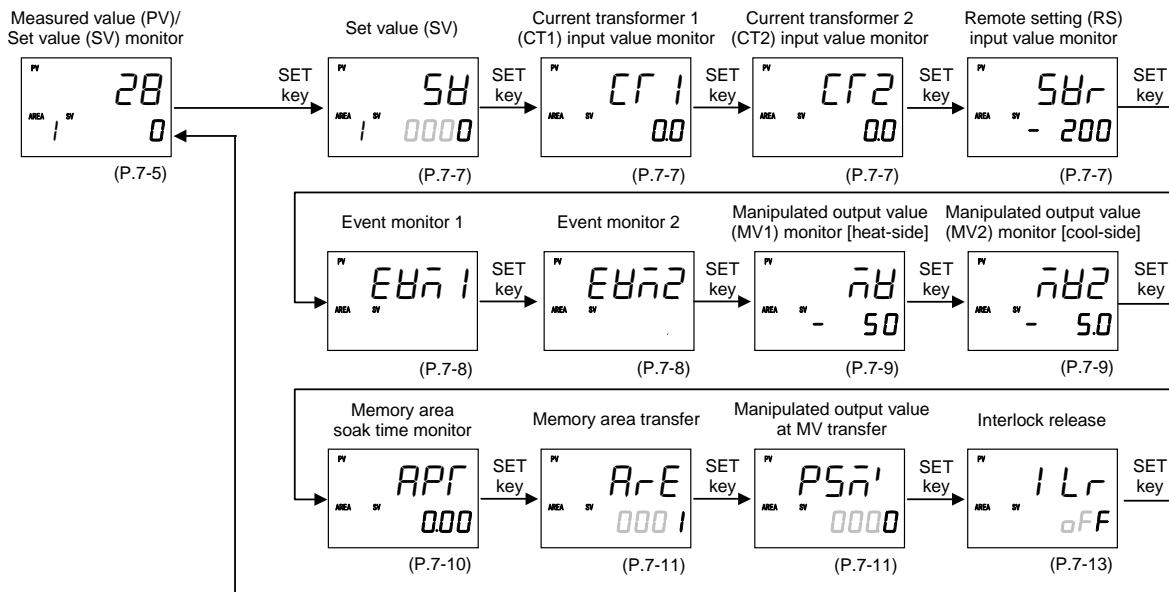

Some parameters may not be displayed when the relevant function is not set so as to be activated or no relevant specification is selected when ordering.





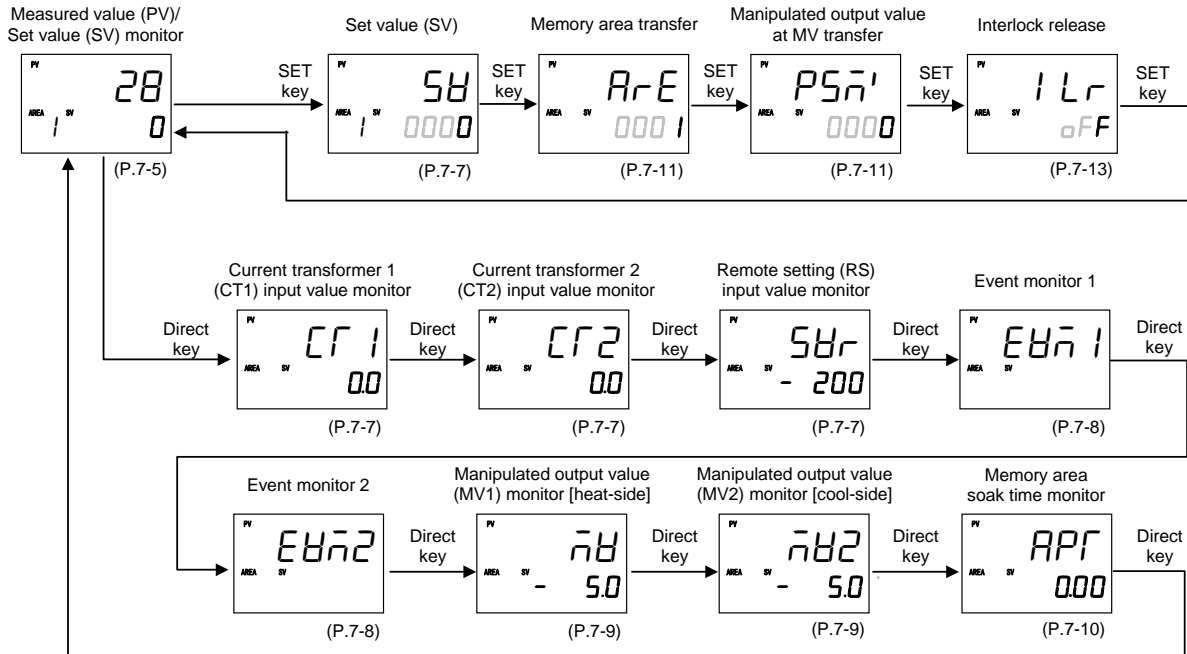





## 7.1.2 Display sequence (When the Direct key type is the Monitor)



Some parameters may not be displayed when the relevant function is not set so as to be activated or no relevant specification is selected when ordering.

### 7.1.3 Monitor and setting item

#### ■ Pictogram description

Pictogram	Name	Description
	Memory area function	Parameters which can be stored in the memory area
	Data lock function	Parameters which can be locked so that no data can be changed.
	Digital input (DI)	Parameters relating to any relevant optional for the FB100 having those optional.
	Remote setting (RS) input	
	Current transformer (CT) input	
	Feedback resistance (FBR) input	
	Communication function (Communication1 or Communication 2)	
	Transmission output (AO)	

## Measured value (PV)/Set value (SV) monitor

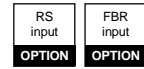

PV monitor

28

SV monitor

0

Measured value (PV) display (hereinafter called the PV display):

Measured value (PV) is displayed.

Set value (SV) display (hereinafter called the SV display):

The target value for control is displayed. The value to be displayed varies depending on the state of operation mode.

- Set value (SV)\* is displayed when the operation mode is Local mode.
- Remote setting input value (RS)\* is displayed when operation mode is Remote mode.



On each controller on the slave side while in Intercontroller communication: For Intercontroller communication ratio setting or Intercontroller communication cascade control, set the controller on the slave side to the remote mode. In this case, the displayed value is that obtained by adding digital filter, bias or ratio to the value from the controller on the master side.

- Manual manipulated output value is displayed when the operation mode is Manual mode. In addition, the Manipulated output value (MV) can be manually set. (Refer to P. 6-28)
  - In the PID control, displays the Manipulated output value (MV1) [heat-side].
  - In the Heat/Cool PID control, displays the Manipulated output value (MV1) [heat-side] or Manipulated output value (MV2) [cool-side].
  - When the control action is the Position proportioning PID control:
    - When the Feedback resistance (FBR) input is provided, Manipulated output value (MV) is displayed. In addition, when the Feedback resistance (FBR) input is not provided, nothing will appear in the SV display.

\* With the Setting change rate limiter when the set value is changed, the displayed set value changes according to the ramp-up/down rate.

Display or data range	Factory set value
Measured value (PV): Input scale low to Input scale high Varies with the setting of the Decimal point position (P. 7-73).	—
Set value (SV) or Remote setting (RS) input value: Setting limiter low to Setting limiter high Varies with the setting of the Decimal point position (P. 7-73).	—
Manipulated output value (MV1 or MV2): PID control: Output limiter low (MV1) to Output limiter high (MV1) (-5.0 to +105.0 %) Heat/Cool PID control: -Output limiter high (MV2) to +Output limiter high (MV1) (-105.0 to +105.0 %)	—



In the STOP mode, displays the “5Γ□P” character on the PV or SV display. Display position of “5Γ□P” can be set in the Engineering mode (P. 7-65).



When Heat/Cool PID control is performed, it is necessary to select Output 2 (OUT2) when ordering.

■ Display processing of Measured value (PV) monitor

The value obtained after a captured input value is processed as shown in the following corresponds to the Measured value (PV) which will be displayed on the PV monitor.

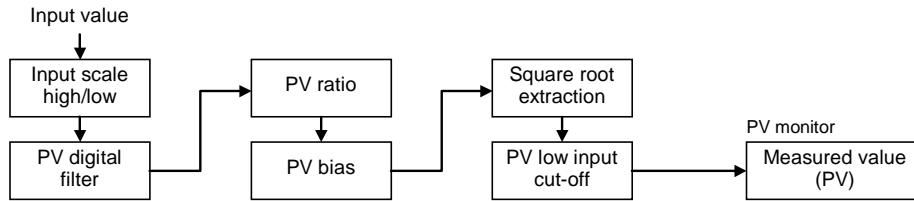

■ Display processing of Set value (SV) monitor

The value obtained after Remote setting (RS) input, Memory area set value (SV) or Local set value (SV) is processed as shown in the following corresponds to the Set value (SV) which will be displayed on the SV monitor.

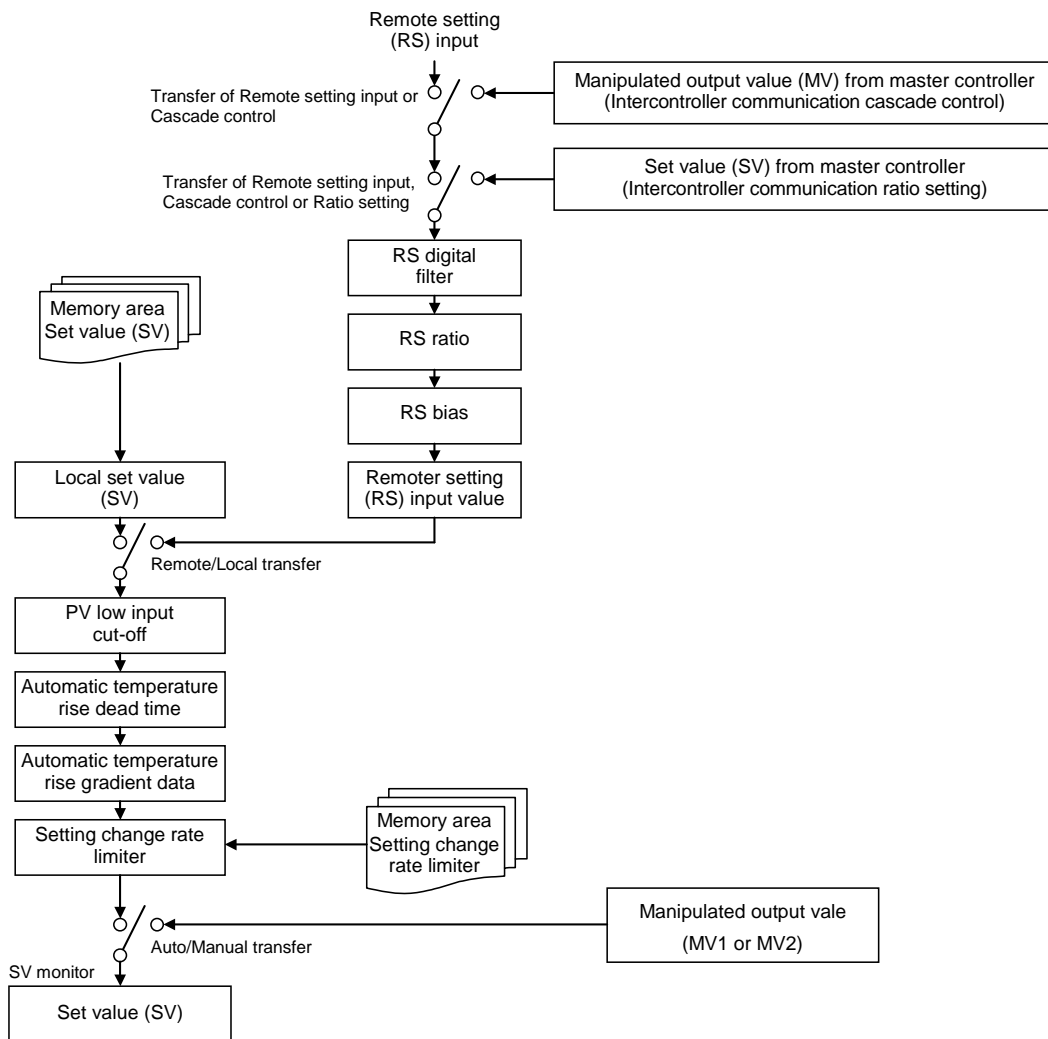

## Set value (SV) [Local set value]



SV

The target value (Local set value) for control can be set.

Data range	Factory set value
Setting limiter low to Setting limiter high Varies with the setting of the Decimal point position (P. 7-73).	0

Related parameter

Engineering mode:

- Decimal point position (P. 7-73)
- Setting limiter high, Setting limiter low (P. 7-164)

## Current transformer 1 (CT1) input value monitor Current transformer 2 (CT2) input value monitor



CT1

The current value captured by the Current transformer (CT) is displayed on the SV display.

CT2

Display range	Factory set value
When CT type is CTL-6-P-N: 0.0 to 30.0 A	—
When CT type is CTL-12-S56-10L-N: 0.0 to 100.0 A	—



This screen is displayed when the Current transformer (CT) input is provided.

## Remote setting (RS) input value monitor



SVr

In remote mode, the Remote setting (RS) input value which becomes the target of control is displayed on the SV display.

Display range	Factory set value
Setting limiter low to Setting limiter high Varies with the setting of the Decimal point position (P. 7-73).	—



This screen is displayed when the Remote setting (RS) input is provided.

Related parameters

Operation mode:

- Remote/Local transfer (P. 7-19)

Setup setting mode:

- RS bias (P. 7-45)
- RS digital filter (P. 7-45)
- RS ratio (P. 7-45)

Engineering mode:

- Decimal point position (P. 7-73)
- Setting limiter high, Setting limiter low (P. 7-164)

## Event monitor 1

In case of event occurrence, “□” is lit in the digit of the SV display. It is possible to check the type of created event depending on which digit was lit.

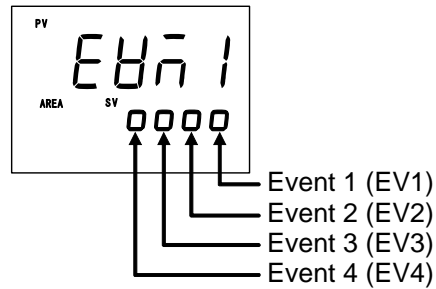

This screen is displayed when event action is selected for any from Event 1 type to Event 4 type.

### Related parameters

Engineering mode:

- Event 1 type (P. 7-88)
- Event 2 type (P. 7-97)
- Event 3 type (P. 7-101)
- Event 4 type (P. 7-105)

## Event monitor 2

CT  
input  
OPTION

In case of Heater break alarm (HBA) occurrence, “□” is lit in the digit of the SV display. It is possible to check the type of Heater break alarm (HBA) which occurred depending on which digit was lit.

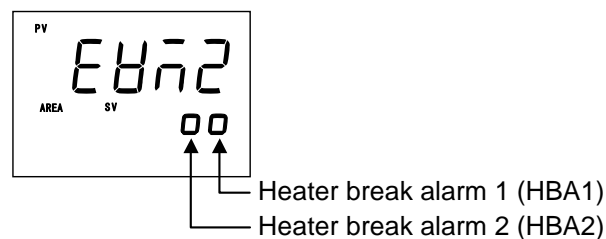

This screen is not displayed when set the CT assignment to “0: None.”

### Related parameters

Engineering mode:

- CT1 assignment (P. 7-113)
- CT2 assignment (P. 7-117)

## Manipulated output value (MV1) monitor [heat-side]

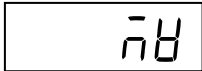

When the control action is PID control or Heat/Cool PID control:

Manipulated output value (MV1) is displayed on the SV display.

When the control action is the Position proportioning PID control:

When Feedback resistance (FBR) input (optional) is used, the SV display shows that Feedback resistance (FBR) input value.

Display details of SV display

Control action	Feedback resistance (FBR) input	Display details
PID control	FBR input is not used.	Manipulated output value (MV1) is displayed.
Heat/Cool PID control		Manipulated output value (MV1) [heat-side] is displayed.
Position proportioning PID control	Not provided	Nothing is displayed.
	Provided *	Feedback resistance (FBR) input value is displayed.

\* When there is Feedback resistance (FBR) input but it is not connected, over-scaling may result to display “□□□□” on the SV display.

Display range	Factory set value
PID control or Heat/Cool PID control: -5.0 to +105.0 %	—
When Feedback resistance (FBR) input is used in Position proportioning PID control: 0.0 to 100.0 %	—



When Feedback resistance (FBR) input is disconnected, over-scaling may result to display “□□□□” on the display.

## Manipulated output value (MV2) monitor [cool-side]

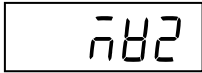

Manipulated output value (MV2) of cool-side is displayed.

Display range	Factory set value
-5.0 to +105.0 %	—

This screen is displayed when in Heat/Cool PID control.

Related parameter

Engineering mode:

- Control action (P. 7-125)

## Memory area soak time monitor

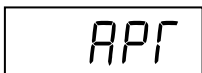

Monitors the time elapsed for memory area operation (soak time) when Ramp/Soak control by using Multi-memory area is performed.

Display example:

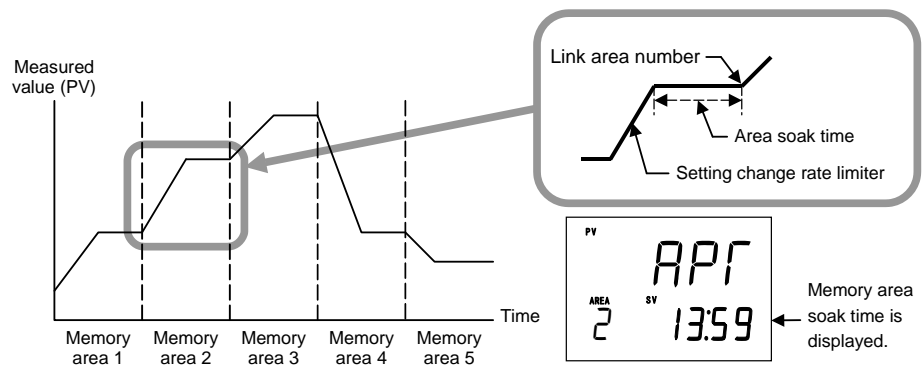

Display range	Factory set value
0 minutes 00 seconds to 199 minutes 59 seconds or 0 hours 00 minutes to 99 hours 59 minutes	—

This screen does not appear when the value of “Digital input (DI) assignment (Engineering mode)” is 6 to 12.

Related parameters

Parameter setting mode:

- Area soak time (P. 7-35)
- Link area number (P. 7-36)

Engineering mode:

- Soak time unit (P. 7-163)





## Memory area transfer

ArE

Selects the memory area (Control area) used for control.

Data range	Factory set value
1 to 8	1

When the Direct key type is Memory area transfer, pressing the Direct key can be changed to the Memory area transfer screen.

Memory area transfer screen is displayed in SV setting & monitor mode when the Direct key type is other than the Memory area transfer.

When External mode (EUF) is set in Control area Local (LOC)/ External (EXT) transfer, “dl” appears in the SV display and the setting cannot be changed.

Related parameter

Operation mode:

- Control area Local (LOC)/External (EXT) transfer (P. 7-20)

Engineering mode:

- Direct key type (P. 7-70)

## Manipulated output value at MV transfer

P5n'

This is the final Manipulated output value used under Manual control when the control mode is transferred to Auto control from Manual control.

Data range	Factory set value
PID control: Output limiter low (MV1) to Output limiter high (MV1) (-5.0 to +105.0 %)	0.0
Heat/Cool PID control: -Output limiter high (MV2) to +Output limiter high (MV1) For overlap: -105.0 to +105.0 % * * Actual output value is limited by the output limiter function.	0.0

This screen is not displayed when the MV transfer function is set to “0.”

Related parameter

Engineering mode:

- MV transfer function (P. 7-124)

Continued on the next page.

Continued from the previous page.

■ **Description of function**

This is the final Manipulated output value used under Manual control when the control mode is transferred to Auto mode from Manual mode. This final Manipulated output value is stored and that displays on the Manipulated output value at MV transfer screen.

This final Manipulated output value is used as a Manipulated output value in Manual control when control mode is transferred to Manual mode next time. (MV transfer function)

**Example 1:**

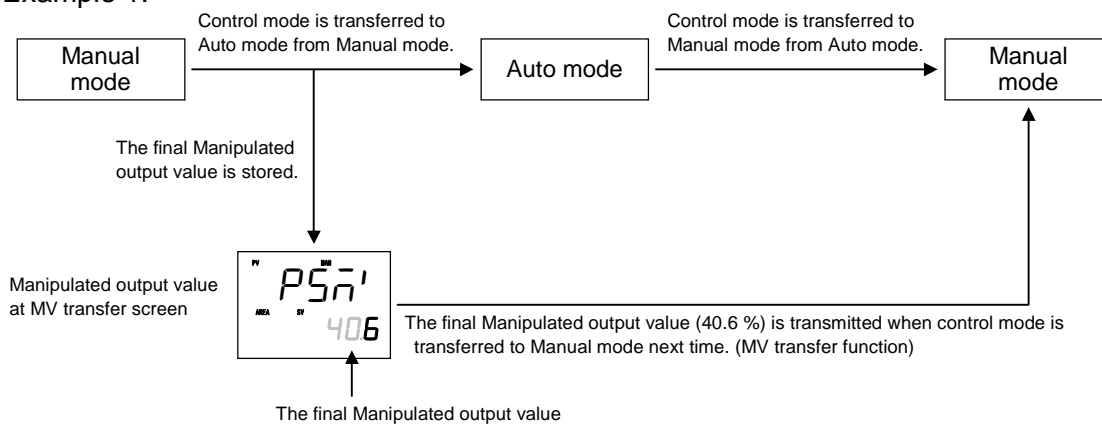

In addition, on this screen it is possible to manually change Manipulated output values (MV1 and MV2) in Auto mode. However, if they are changed in Auto mode, these manipulated output values thus changed are transferred when selected to the Manual mode next time.

**Example 2:**

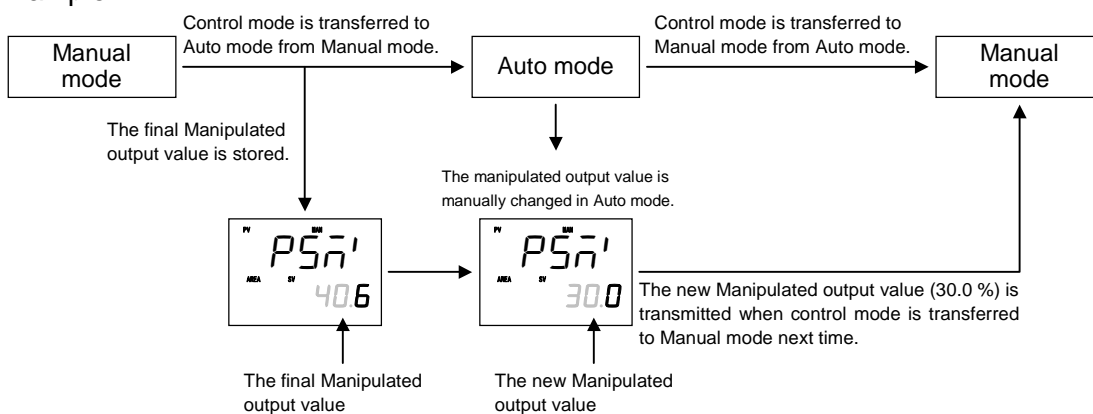

Manipulated output value can be changed by the UP, DOWN or shift keys.

## Interlock release

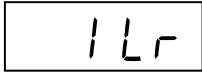

Displays the interlock status.

If the event state is interlocked, interlock can be released by pushing the DOWN key.

Data range	Factory set value
on (on): Interlock	oFF (oFF)
oFF (oFF): Interlock release	



This screen is not displayed when all of Event 1 interlock to Event 4 interlock are set to “Unused.”

### Related parameters

Engineering mode:

- Event 1 interlock (P. 7-92)
- Event 2 interlock (P. 7-99)
- Event 3 interlock (P. 7-103)
- Event 4 interlock (P. 7-108)

## 7.2 Operation Mode

The Operation mode is used to select the operation modes (PID/AT, Auto/Manual, Remote/Local or RUN/STOP) of the instrument.

In addition, the Startup tuning (ST) and Automatic temperature rise learning function can be set.

### 7.2.1 Display sequence

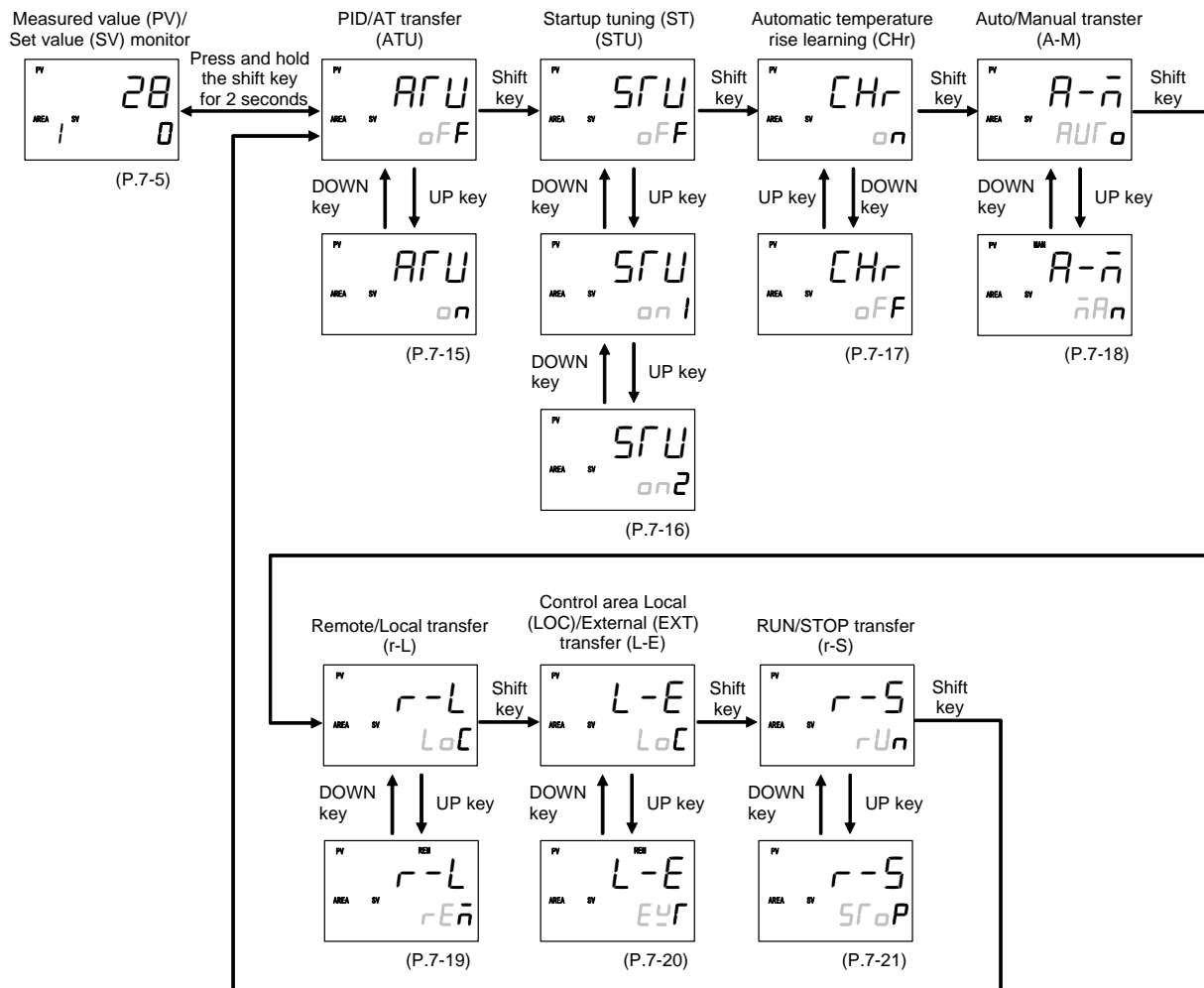

The SET key as well as the shift key enables the transfer of operation items.



Some parameters may not be displayed when the relevant function is not set so as to be activated or no relevant specification is selected when ordering.



Display returns to the SV setting & monitor mode if no key operation is performed within 1 minute.

## 7.2.2 Operation item

### PID/AT transfer

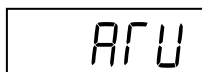

Activation or deactivation of the Autotuning (AT) function is selected.

Data range	Factory set value
on (on): Autotuning (AT)	oFF (oFF)
oFF (oFF): PID control	

 For the activating method and condition of the Autotuning (AT) function, refer to **6.5 Autotuning (AT) (P. 6-15)**.

#### Related parameters

Engineering mode:



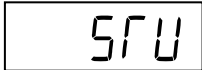

- AT bias (P. 7-140)
- AT cycles (P. 7-141)
- AT differential gap time (P. 7-142)
- Output value with AT turned on, Output value with AT turned off (P. 7-143)
- Proportional band limiter (high) [heat-side],  
Proportional band limiter (low) [heat-side] (P. 7-144)
- Integral time limiter (high) [heat-side],  
Integral time limiter (low) [heat-side] (P. 7-145)
- Derivative time limiter (high) [heat-side],  
Derivative time limiter (low) [heat-side] (P. 7-146)
- Proportional band limiter (high) [cool-side],  
Proportional band limiter (low) [cool-side] (P. 7-147)
- Integral time limiter (high) [cool-side],  
Integral time limiter (low) [cool-side] (P. 7-148)
- Derivative time limiter (high) [cool-side],  
Derivative time limiter (low) [cool-side] (P. 7-149)
- Proportional band adjusting factor [heat-side],  
Proportional band adjusting factor [cool-side] (P. 7-150)
- Integral time adjusting factor [heat-side],  
Integral time adjusting factor [cool-side] (P. 7-150)
- Derivative time adjusting factor [heat-side],  
Derivative time adjusting factor [cool-side] (P. 7-151)

## Startup tuning (ST)



Use to set the number of execution times of Startup tuning (ST).

Data range	Factory set value
on1 (on1): Execute once	oFF (oFF)
on2 (on2): Execute always	
oFF (oFF): ST unused	

-  This screen is displayed when in Position proportioning PID control.
-  When in Heat/Cool PID control, it is possible to execute the Startup tuning (ST) function only in the temperature rise direction. The PID values on the heat side are automatically computed.
-  If the optimum PID constants cannot be obtained by the Startup tuning (ST), please execute the Autotuning (AT).
-  For details of the Startup tuning (ST), refer to **6.6 Startup Tuning (ST) (P. 6-18)**.

### Related parameters

Engineering mode:

- ST start condition (P. 7-157)
- ST proportional band adjusting factor (P. 7-157)
- ST integral time adjusting factor (P. 7-158)
- ST derivative time adjusting factor (P. 7-158)

### ■ Description of function

The Startup tuning (ST) function is used to automatically compute PID constants from the temperature rise characteristic (gradient: arrival time to SV) when power is turned on or the Set value (SV) is changed. If the Startup tuning (ST) function is used for any equipment which requires a long period of time for executing the Autotuning (AT) function, no time of executing the Autotuning (AT) function becomes necessary.

Timing of activating the Startup tuning (ST) can be selected from among the following three types.

- Activate the Startup tuning (ST) function when the power is turned on; when transferred from STOP to RUN; or when the Set value (SV) is changed.
- Activate the Startup tuning (ST) function when the power is turned on; or when transferred from STOP to RUN.
- Activate the Startup tuning (ST) function when the Set value (SV) is changed.

Activate the Startup tuning (ST) function when the power is turned on; or when transferred from STOP to RUN.

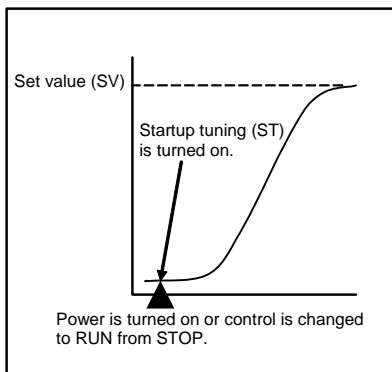

Activate the Startup tuning (ST) function when the Set value (SV) is changed.

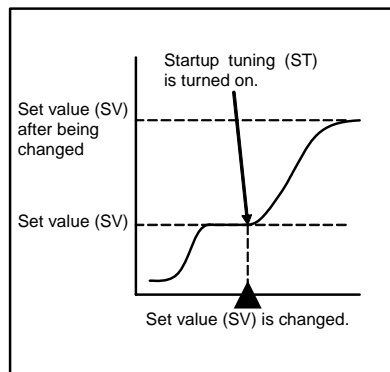

Activate the Startup tuning (ST) function when the power is turned on; when transferred from STOP to RUN; or when the Set value (SV) is changed.

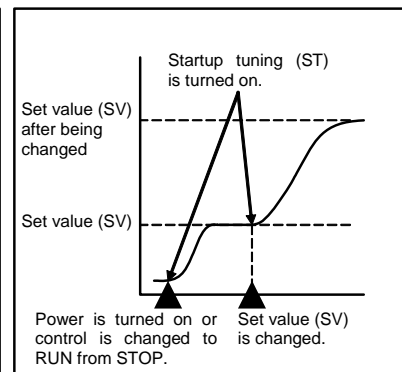

## Automatic temperature rise learning

CHr

Use to select Use/Unuse of the Automatic temperature rise learning function.

Data range	Factory set value
on (on): Learning	on (on)
oFF (oFF): Unused	



This screen is not displayed when set the Automatic temperature rise group to “0.”



When in Heat/Cool PID control, an Automatic temperature rise only in the temperature rise direction is enabled.



For details of the Automatic temperature rise learning function, refer to **6.14.4 Automatic temperature rise function (with learning function) (P. 6-72)**.

### Related parameters

Engineering mode:

- Automatic temperature rise group (P. 7-159)
- Automatic temperature rise dead time (P. 7-161)
- Automatic temperature rise gradient data (P. 7-161)

### ■ Description of function

This is the function to find Automatic temperature rise dead time and Automatic temperature rise gradient data necessary for an Automatic temperature rise. Learning starts if set to “on: Learning” and changed to control RUN to STOP. After Automatic temperature rise dead time and Automatic temperature rise gradient data are found, the learning function is deactivated.

## Auto/Manual transfer



Use to transfer the Auto mode or Manual mode.

Auto mode: Automatic control is performed.

Manual mode: The Manipulated output value (MV1 or MV2) can be manually changed. The Manipulated output value can be changed on the Measured value (PV)/Set value (SV) monitor.

Data range	Factory set value
$R_{Uf} \square$ (AUto): Auto mode	$R_{Uf} \square$ (AUto)
$\bar{m}R_m$ (MAn): Manual mode	

When the Direct key type is Auto/Manual transfer, pressing the Direct key can be changed to the Auto/Manual transfer screen.

Even when in Auto mode, it is possible to manually change the manipulated output value on the Manipulated output value at MV transfer screen.

For details of the Auto/Manual transfer, refer to **6.7 Auto/Manual transfer (P. 6-23)**.

Related parameters

Engineering mode:

- Direct key type (P. 7-70)



## Remote/Local transfer

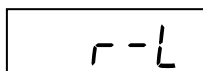
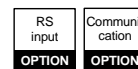

Use to transfer the Remote mode or Local mode.

Local mode: Control is performed at the Local set value (SV).

Remote mode: Control is performed with a Remote setting (RS) input value.

Data range	Factory set value
LoC (LoC): Local mode	LoC (LoC)
rEM (rEM): Remote mode	

- When the Direct key type is Remote/Local transfer, pressing the Direct key can be changed to the Remote/Local transfer screen.
- For Intercontroller communication ratio setting or Intercontroller communication cascade control, set the controller on the slave side to the Remote mode.
- This screen is displayed when the Remote setting (RS) input or Communication function is provided.
- For details of the Remote/Local transfer, refer to **6.8 Remote/Local Transfer (P. 6-29)**.
- For details of the Intercontroller communication function, refer to **6.14 Group Operation by the Intercontroller Communication (P. 6-61)**.

### Related parameters

Engineering mode:

- Direct key type (P. 7-70)
- External input type (P. 7-121)
- SV tracking (P. 7-123)

## Control area Local/External transfer

L-E
-----

When control area transfer by Digital input (DI) will be performed and memory area transfer with no memory area set input (set value: 6 to 12) is selected in Digital input (DI) assignment of Engineering mode, specify whether “Memory area transfer by Front key or Communication” or “Memory area transfer by Digital input (DI)” is enabled.

Local mode: Enable memory area transfer by Front key or Communication.

External mode: Enable memory area transfer by Digital input (DI).

Data range	Factory set value
LoC (LoC): Local mode	LoC (LoC)
EXT (EXT): External mode	

 In External mode, “*dl*” appears in the SV display of the Memory area transfer screen and key input is not possible.

 This screen appears when the value of Digital input (DI) assignment (Engineering mode) is 6 to 12.

 For transfer method of control area, refer to **6.9 Control Area Transfer (P. 6-33)**.

### Related parameters

SV setting & Monitor mode:

- Memory area transfer (P. 7-11)

Engineering mode:

- Digital input (DI) assignment (P. 7-80)

## RUN/STOP transfer

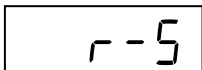

Use to transfer the RUN (control RUN) or STOP (control STOP).

Data range	Factory set value
rUn: RUN (Control RUN)	rUn
SToP: STOP (Control STOP)	

 When the Direct key type is RUN/STOP transfer, pressing the Direct key can be changed to the RUN/STOP transfer screen.

 For details of the RUN/STOP transfer, refer to **6.4 RUN/STOP Transfer (P. 6-11)**.

 If the Group RUN/STOP function is used, refer to **6.14.3 Group RUN/STOP function (P. 6-64)**.

### Related parameters

Engineering mode:

- Direct key type (P. 7-70)

# 7.3 Parameter Setting Mode

Parameters of Parameter setting mode can be stored in the memory area.

## ■ Multi-memory area function

Multi-memory area function can store up to 8 individual sets of SVs and parameters in Parameter setting mode.

One of the Areas is used for control, and the currently selected area is Control area.

If the set values are stored in divided memory areas for each work process, it is possible to collectively call up all of these set values necessary for the process simply by changing the corresponding memory area numbers.

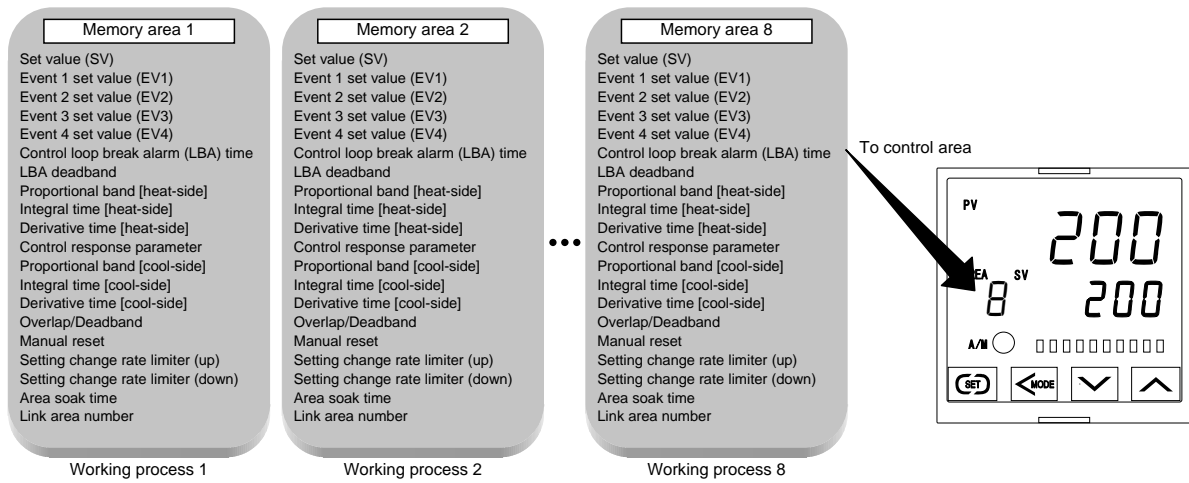

In addition, it is possible to perform Ramp/Soak control by linking each memory area. It is possible to perform Ramp/Soak control of up to 16 segments (8 steps).

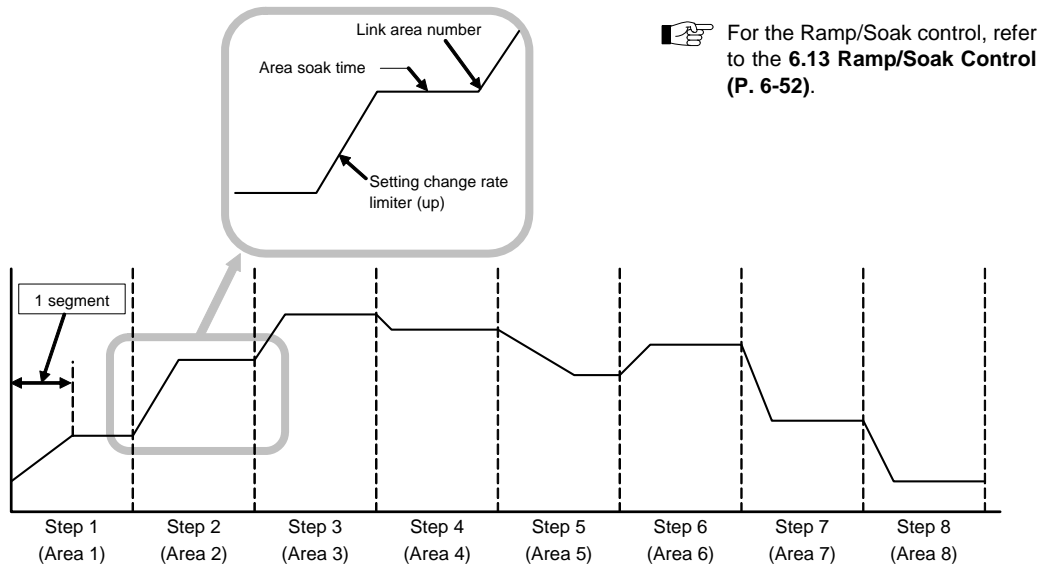

### 7.3.1 Display sequence

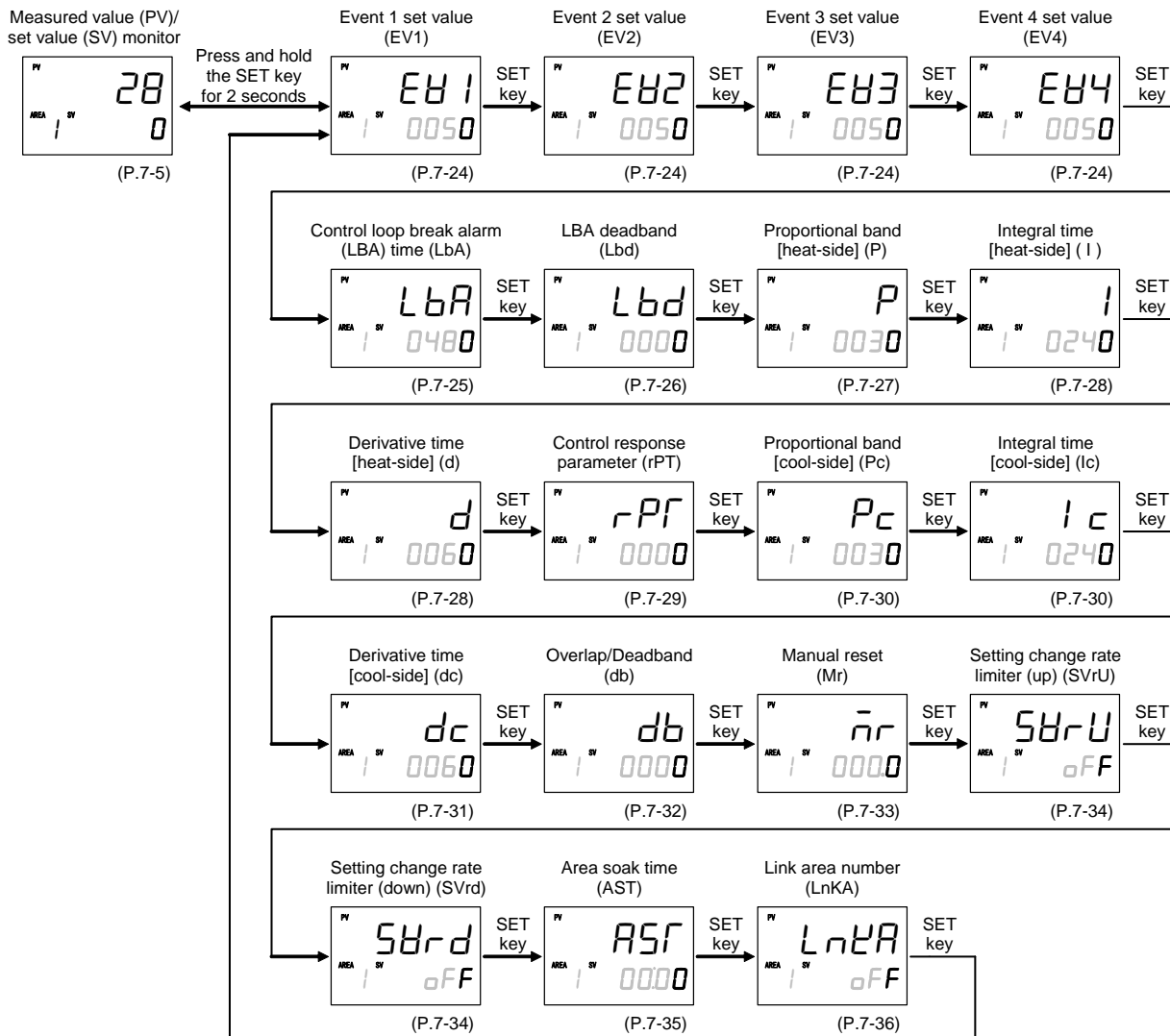

Some parameters may not be displayed when the relevant function is not set so as to be activated or no relevant specification is selected when ordering.



Display returns to the SV setting & monitor mode if no key operation is performed within 1 minute.

## 7.3.2 Parameter setting item

Event 1 set value (EV1)    Event 3 set value (EV3)  
Event 2 set value (EV2)    Event 4 set value (EV4)



EV1

EV2

EV3

EV4

EV1 through EV4 are set values of the event action.

Signals are output from the Digital outputs (DO1 to DO4) if exceeding the Event set value.

Data range	Factory set value
When the event action is the deviation*: –Input span to +Input span Varies with the setting of the Decimal point position (P. 7-73).	50
* Deviation: Deviation high, Deviation low, Deviation high/low and Band	
When the event action is the input value or set value: Input scale low to Input scale high Varies with the setting of the Decimal point position (P. 7-73).	50
When the event action is the manipulated output value (MV1 or MV2): –5.0 to +105.0 %	50

These screens are not displayed when the type of the Event 1, 2, 3 and 4 is set to “0: None.”

The Event 4 set value (EV4) screen is not displayed when the Event 4 is used as a “9: Control loop break alarm (LBA).”

For the setting method of Event set value, refer to **6.3.2 Set the event set value (alarm set value) (P. 6-7)**.

### Related parameters

Engineering mode:

- Decimal point position (P. 7-73)
- Alarm (ALM) lamp lighting condition 1 (P. 7-84)
- Event 1 type (P. 7-88)
- Event 2 type (P. 7-97)
- Event 3 type (P. 7-101)
- Event 4 type (P. 7-105)
- Event 1 hold action (P. 7-90)
- Event 2 hold action (P. 7-98)
- Event 3 hold action (P. 7-102)
- Event 4 hold action (P. 7-107)
- Event 1 interlock (P. 7-92)
- Event 2 interlock (P. 7-99)
- Event 3 interlock (P. 7-103)
- Event 4 interlock (P. 7-108)
- Event 1 differential gap (P. 7-93)
- Event 2 differential gap (P. 7-99)
- Event 3 differential gap (P. 7-103)
- Event 4 differential gap (P. 7-109)
- Event 1 delay timer (P. 7-94)
- Event 2 delay timer (P. 7-100)
- Event 3 delay timer (P. 7-104)
- Event 4 delay timer (P. 7-110)
- Force ON of Event 1 action (P. 7-96)
- Force ON of Event 2 action (P. 7-100)
- Force ON of Event 3 action (P. 7-104)
- Force ON of Event 4 action (P. 7-111)

## Control loop break alarm (LBA) time



LBA

The LBA time sets the time required for the LBA function to determine there is a loop failure. When the LBA is output (under alarm status), the LBA function still monitors the Measured value (PV) variation at an interval of the LBA time.

Data range	Factory set value
1 to 7200 seconds OFF (oFF): Unused	480

The Event 4 set value (EV4) screen is displayed when the Event 4 is used as a “9: Control loop break alarm (LBA).”

### Related parameters

Parameter setting mode:

- LBA deadband (P. 7-26)

Engineering mode:

- Event 4 type (P. 7-105)
- Event 4 interlock (P. 7-108)
- Event 4 delay timer (P. 7-110)

### ■ Description of function

The Control loop break alarm (LBA) function is used to detect a load (heater) break or a failure in the external actuator (power controller, magnet relay, etc.), or a failure in the control loop caused by an input (sensor) break. The LBA function is activated when control output reaches 0 % (low limit with output limit function) or 100 % (high limit with output limit function). LBA monitors variation of the Measured value (PV) for the length of LBA time. When the LBA time has elapsed and the PV is still within the alarm determination range, the LBA will be ON.

#### [Alarm action]

LBA determination range: TC/RTD inputs: 2 °C [°F] (fixed)  
Voltage/Current inputs: 0.2 % of input span (fixed)

#### • When the output reaches 0 % (low limit with output limit function)

For direct action: When the LBA time has passed and the PV has not risen beyond the alarm determination range, the alarm will be turned on.

For reverse action: When the LBA time has passed and the PV has not fallen below the alarm determination range, the alarm will be turned on.

#### • When the output exceeds 100 % (high limit with output limit function)

For direct action: When the LBA time has passed and the PV has not fallen below the alarm determination range, the alarm will be turned on.

For reverse action: When the LBA time has passed and the PV has not risen beyond the alarm determination range, the alarm will be turned on.



If the Autotuning function is used, the LBA time is automatically set twice as large as the Integral time. The LBA setting time will not be changed even if the Integral time is changed.



## LBA deadband

Lbd

The LBA deadband gives a neutral zone to prevent the Control loop break alarm (LBA) from malfunctioning caused by disturbance.

Data range	Factory set value
0 to Input span Varies with the setting of the Decimal point position (P. 7-73).	0

The Event 4 set value (EV4) screen is displayed when the Event 4 is used as a “9: Control loop break alarm (LBA).”

### Related parameters

Parameter setting mode:

- Control loop break alarm (LBA) time (P. 7-25)

Engineering mode:

- Decimal point position (P. 7-73)
- Event 4 type (P. 7-105)
- Event 4 interlock (P. 7-108)
- Event 4 delay timer (P. 7-110)

### ■ Description of function

The LBA may malfunction due to external disturbances. To prevent malfunctioning due to external disturbance, LBA deadband (LBD) sets a neutral zone in which LBA is not activated. When the Measured value (PV) is within the LBD area, LBA will not be activated. If the LBD setting is not correct, the LBA will not work correctly.

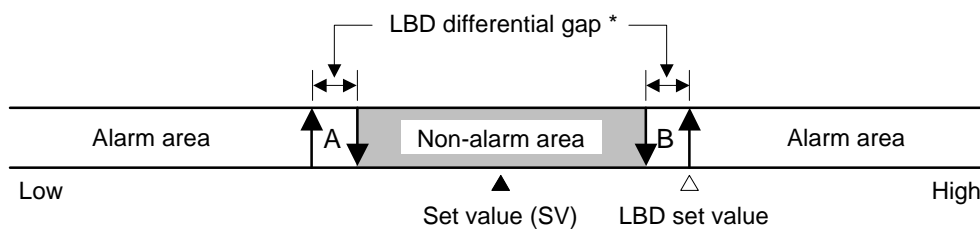

\* TC/RTD inputs: 0.8 °C [°F] (fixed) Voltage/Current inputs: 0.8 % of input span (fixed)

A: During temperature rise: Alarm area      During temperature fall: Non-alarm area  
 B: During temperature rise: Non-alarm area      During temperature fall: Alarm area



If the LBA function detects an error occurring in the control loop, but cannot specify the location, a check of the control loop in order. The LBA function does not detect a location which causes alarm status. If LBA alarm is ON, check each device or wiring of the control loop.

Continued on the next page.



Continued from the previous page.



LBA function is not operative when:

- AT function is activated.
- The controller is in STOP mode.
- The control type is Heat/Cool PID control.
- LBA function is set to “0.”
- LBA function is not assigned to Event 4 (ES4).



If the LBA time is too short or does not match the controlled object requirements, LBA may turn ON or OFF at inappropriate time or remain OFF. Change the LBA time based on the malfunction.



While the LBA is ON (under alarm status), the following conditions cancel the alarm status and LBA will be OFF:

- The Measured value (PV) rises beyond (or falls below) the LBA determination range within the LBA time.
- The Measured value (PV) enter within the LBA deadband.

## Proportional band [heat-side]

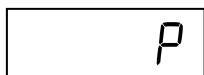

This is a Proportional band in P, PI, PD or PID control. When in Heat/Cool PID control, it becomes the Proportional band on the heat side.

Data range	Factory set value
TC/RTD inputs: 0 (0.0, 0.00) to Input span (Unit: °C [°F]) 0 (0.0, 0.00): ON/OFF action Varies with the setting of the Decimal point position (P. 7-73).	30 (30.0, 30.00)
Voltage (V)/Current (I) inputs: 0.0 to 1000.0 % of input splay 0.0: ON/OFF action	30.0

### Related parameters

Parameter setting mode:

- Overlap/Deadband (P. 7-32)

Engineering mode:

- Decimal point position (P. 7-73)
- ON/OFF action differential gap (upper),  
ON/OFF action differential gap (lower) (P. 7-130)
- Overlap/Deadband reference point (P. 7-146)



## Integral time [heat-side]



Integral action is to eliminate offset between SV and PV by proportional action. The degree of Integral action is set by time in seconds.

When in Heat/Cool PID control, it becomes the Integral time on the heat side.

Data range	Factory set value
PID control or Heat/Cool PID control: 1 to 3600 seconds or 0.1 to 1999.9 seconds oFF (oFF): PD action (Heat/Cool PID control: heat-side and cool-side are both PD action)	240
Position proportioning PID control: 1 to 3600 seconds or 0.1 to 1999.9 seconds	240

Data range varies depending on the Integral/Derivative time decimal point position (P. 7-129).

Data range	Integral/Derivative time decimal point position setting
1 to 3600 seconds or 1 to 3600 seconds	0: 1 second setting (No decimal place)
0.1 to 1999.9 seconds	1: 0.1 seconds setting (One decimal place)

Related parameter

Engineering mode:

- Integral/Derivative time decimal point position (P. 7-129)



## Derivative time [heat-side]

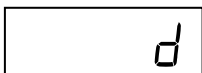

Derivative action is to prevent rippling and make control stable by monitoring output change. The degree of derivative action is set by time in seconds.

When in Heat/Cool PID control, it becomes the Derivative time on the heat side.

Data range	Factory set value
1 to 3600 seconds or 0.1 to 1999.9 seconds oFF (oFF): PI action	60

Data range varies depending on the Integral/Derivative time decimal point position (P. 7-129).

Data range	Integral/Derivative time decimal point position setting
1 to 3600 seconds	0: 1 second setting (No decimal place)
0.1 to 1999.9 seconds	1: 0.1 seconds setting (One decimal place)

Related parameters

Engineering mode:

- Integral/Derivative time decimal point position (P. 7-129)
- Derivative gain (P. 7-129)

## Control response parameter

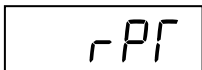

The control response for the Set value (SV) change can be selected among Slow, Medium, and Fast.

Data range	Factory set value
0: Slow	PID control, Position
1: Medium	proportioning PID control: 0
2: Fast	Heat/Cool PID control: 2

### ■ Description of function

The control response for the Set value (SV) change can be selected among Slow, Medium, and Fast. If a fast response is required, Fast is chosen. Fast may cause overshoot. If overshoot is critical, Slow is chosen.

Fast	Selected when rise time needs to be shortened (operation needs to started fast). However in this case, slight overshooting may not be avoided.
Medium	Middle between “Fast” and “Slow.” Overshooting when set to “Medium” becomes less than that when set to “Fast.”
Slow	Selected when no overshooting is allowed. Used when material may be deteriorated if the temperature becomes higher that the set value.

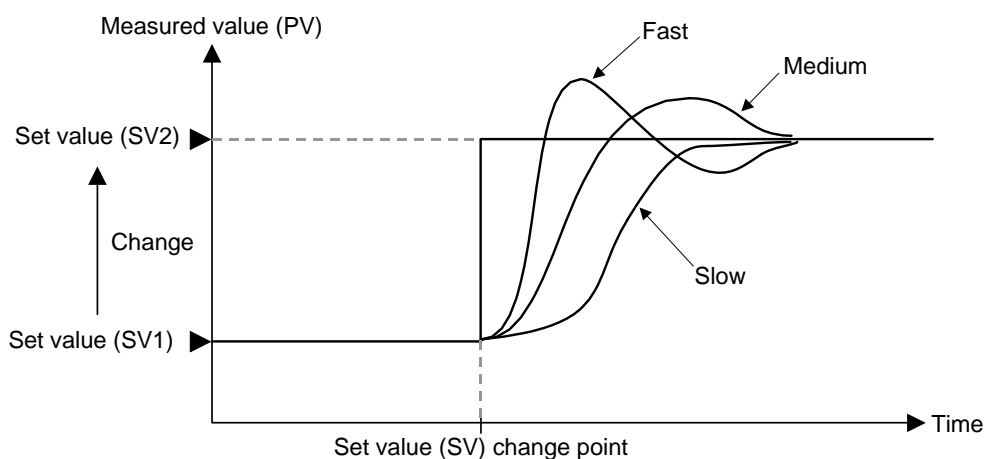

When the P or PD action is selected, this setting becomes invalid.

## Proportional band [cool-side]



$P_c$

This is a Proportional band for the cool side in Heat/Cool P, PI, PD or PID control.

Data range	Factory set value
TC/RTD inputs: 1 (0.1, 0.01) to Input span (Unit: °C [°F]) Varies with the setting of the Decimal point position (P. 7-73).	30 (30.0, 30.00)
Voltage (V)/Current (I) inputs: 0.1 to 1000.0 % of input span	30.0

This screen is displayed when in Heat/Cool PID control.

### Related parameters

Parameter setting mode:

- Overlap/Deadband (P. 7-32)

Engineering mode:

- Decimal point position (P. 7-73)
- Control action (P. 7-125)
- Overlap/Deadband reference point (P. 7-146)

## Integral time [cool-side]



$I_c$

Integral action [cool-side] is to eliminate offset between SV and PV by proportional action of cool-side. The degree of Integral action [cool-side] is set by time in seconds.

Data range	Factory set value
1 to 3600 seconds or 0.1 to 1999.9 seconds OFF (oFF): PD action (Heat/Cool PID control: heat-side and cool-side are both PD action)	240

Data range varies depending on the Integral/Derivative time decimal point position (P. 7-129).

Data range	Integral/Derivative time decimal point position setting
1 to 3600 seconds	0: 1 second setting (No decimal place)
0.1 to 1999.9 seconds	1: 0.1 seconds setting (One decimal place)

This screen is displayed when in Heat/Cool PID control.

### Related parameters

Engineering mode:

- Control action (P. 7-125)
- Integral/Derivative time decimal point position (P. 7-129)

## Derivative time [cool-side]



$dc$

Derivative action of cool-side is to prevent rippling and make control stable by monitoring output change. The degree of Derivative action [cool-side] is set by time in seconds.

Data range	Factory set value
1 to 3600 seconds or 0.1 to 1999.9 seconds oFF (oFF): PI action	60

Data range varies depending on the Integral/Derivative time decimal point position (P. 7-129).

Data range	Integral/Derivative time decimal point position setting
1 to 3600 seconds	0: 1 second setting (No decimal place)
0.1 to 1999.9 seconds	1: 0.1 seconds setting (One decimal place)

This screen is displayed when in Heat/Cool PID control.

### Related parameters

Engineering mode:

- Control action (P. 7-125)
- Integral/Derivative time decimal point position (P. 7-129)
- Derivative gain (P. 7-129)



## Overlap/Deadband

db

This is the overlapped range of Proportional bands (on the heat and cool sides) or the deadband range when Heat/Cool PID control is performed.

Data range	Factory set value
TC/RTD inputs: –Input span to +Input span (Unit: °C [°F]) Varies with the setting of the Decimal point position (P. 7-73).	0
Voltage (V)/Current (I) inputs: –100.0 to +100.0 % of Input span	0.0

Minus (–) setting results is Overlap. However, the overlapping range is limited to the Proportional band [heat-side] set range or the Proportional band [cool-side] set range, whichever is smaller.

This screen is displayed when in Heat/Cool PID control.

### Related parameters

Parameter setting mode:

- Proportional band [heat-side] (P. 7-27)
- Proportional band [cool-side] (P. 7-30)

Engineering mode:

- Decimal point position (P. 7-73)
- Control action (P. 7-125)
- Overlap/Deadband reference point (P. 7-146)

### ■ Description of function

**Overlap (OL):** Range in which the Proportional band [heat-side] and the Proportional band [cool-side] are overlapped. If a Measured value (PV) is within the overlapped range, Manipulated output values (MV1 and MV2) may be simultaneously output.

**Deadband (DB):** This is a control dead zone existing between the Proportional band [heat-side] and the Proportional band [cool-side]. If a Measured value (PV) is within the deadband range, neither the Manipulated output value (MV1) nor the Manipulated output value (MV2) is output.

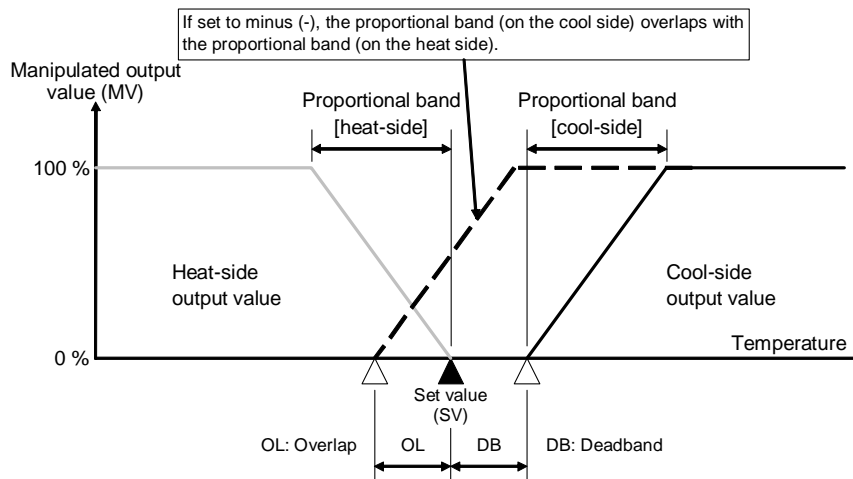

The diagram is an example when setting 0.0 to the Overlap/Deadband reference point. For Overlap/Deadband reference point, refer to P. 7-146.

## Manual reset

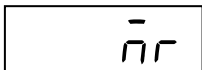

In order to eliminate the offset occurring in Proportional (P) control, the Manipulated output value is manually corrected.

- When the Manual reset is set to the plus (+) side:  
The Manipulated output value under the stable condition increases by the Manual reset value.
- When the Manual reset is set to the minus (–) side:  
The Manipulated output value under the stable condition decreases by the Manual reset value.

Data range	Factory set value
–100.0 to +100.0 %	0.0



This screen is displayed when the Integral time [heat-side or cool-side] is turned off.

### Related parameters

Parameter setting mode:

- Integral time [heat-side] (P. 7-28)
- Integral time [cool-side] (P. 7-30)

### ■ Description of function

This is the function used to manually correct the offset when in Proportional (P) control or PD control. Offset means the deviation of the actual when the Manipulated output value becomes stabilized (stable state). If the Manual reset value varies, the Manipulated output value also changes.

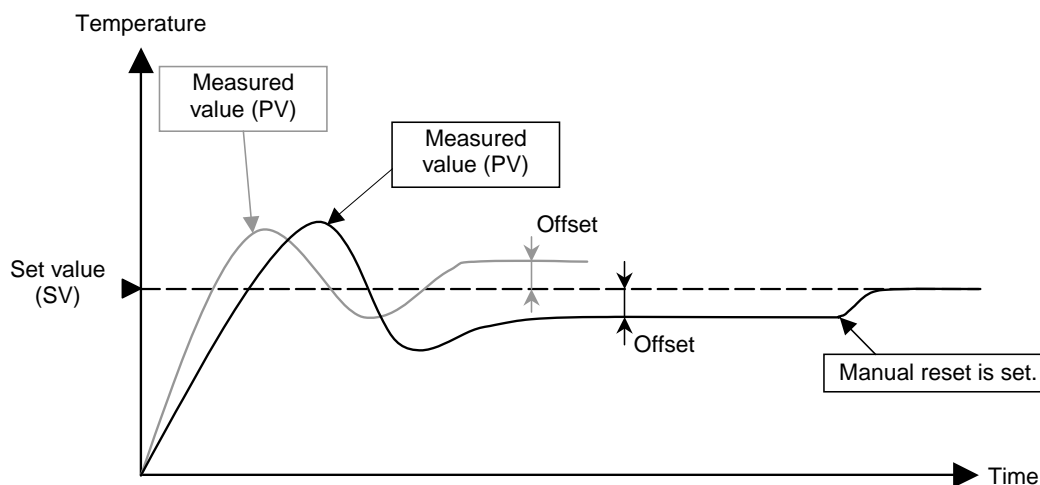

## Setting change rate limiter (up)

## Setting change rate limiter (down)



SVrU

SVrd

This function is to allow the Set value (SV) to be automatically changed at specific rates when a new Set value (SV).

SVrU is used when the SV is changed to a higher SV.

SVrd is used when the SV is changed to a lower SV.

Data range	Factory set value
1 (0.1, 0.01) to Input span/unit time oFF (oFF): Unused Varies with the setting of the Decimal point position (P. 7-73).	oFF (oFF)

The unit time of the Setting change rate limiter can be change in the range of 1 to 3600 seconds. The unit time is set on the setting change rate limiter unit time (P. 7-163).

### Related parameter

Engineering mode:

- Decimal point position (P. 7-73)
- Setting change rate limiter unit time (P. 7-163)

### ■ Description of function

This function is to allow the Set value (SV) to be automatically changed at specific rates when a new Set value (SV). SVrU is used when the SV is changed to a higher SV. SVrd is used when the SV is changed to a lower SV.

[Application examples of Setting change rate limiter]

#### • Increasing the SV to a higher value

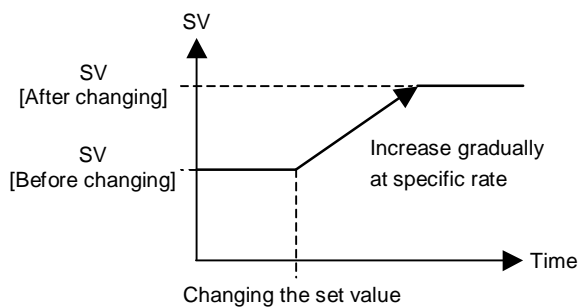

#### • Decreasing the SV to a lower value

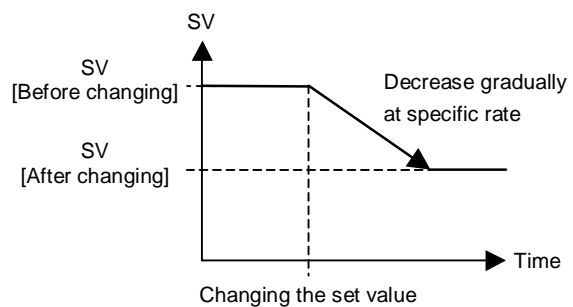

When the Setting change rate limiter is used, the SV will also ramp up or ramp down by the function at power-on and operation mode change from STOP to RUN.

If the Autotuning (AT) function is activated while the SV is ramping up or ramping down by the Setting change rate limiter, AT will starts after the SV finishes ramp-up or ramp-down by the limiter, and the controller is in PID control mode until AT starts.

When the value of Setting change rate limiter is changed during normal operation, the ramp-up or ramp-down rate will be changed unless the SV already has finished ramp-up or ramp-down by the function.

If the rate of Setting change limiter is set to any value other than “OFF (Unused),” the event re-hold action to be taken by a Set value (SV) change becomes invalid.



## Area soak time



ASr

This is the time required until transferred to the link area number when performing Ramp/Soak control.

Data range	Factory set value
0 minutes 00 seconds to 199 minutes 59 seconds 0 hours 00 minutes to 99 hours 59 minutes	0:00

This screen does not appear when the value of Digital input (DI) assignment (Engineering mode) is 6 to 12.

Data range is selected on the soak time unit (P. 7-163).

### Related parameter

Parameter setting mode:

- Link area number (P. 7-36)

Engineering mode:

- Soak time unit (P. 7-163)

### ■ Description of function

Area soak time is used for Ramp/Soak control function in conjunction with Link area number and Setting change rate limiter (up/down).

[Application examples of Area soak time]

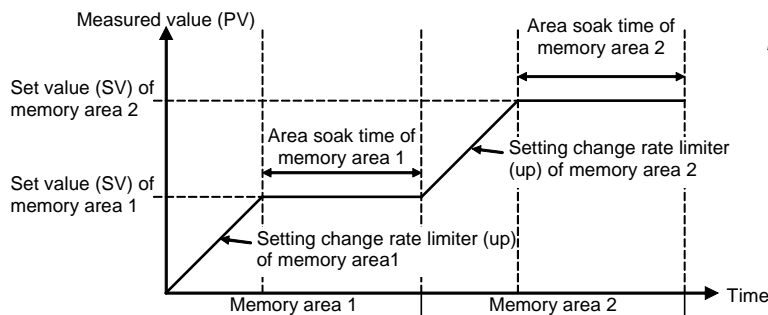

The Area soak time for the memory area linked last becomes invalid to continue the state of the Set value (SV) reached.

Time required while the Setting change rate limiter is being operated is not included in the Area soak time.

The Area soak time can be changed during normal operation with Ramp/Soak control function, but read the following example carefully how the time change affects Ramp/Soak control time. For example, the memory area which has 5-minute soak time is executed. When 3 minutes passed, the Area soak time is changed from 5 minutes to 10 minutes. The remaining time of the currently executed memory area is computed as follows. (The new soak time 10 minutes) – (lapsed time 3 minutes) = (remaining time 7 minutes) The old soak time does not have any effect on remaining time.

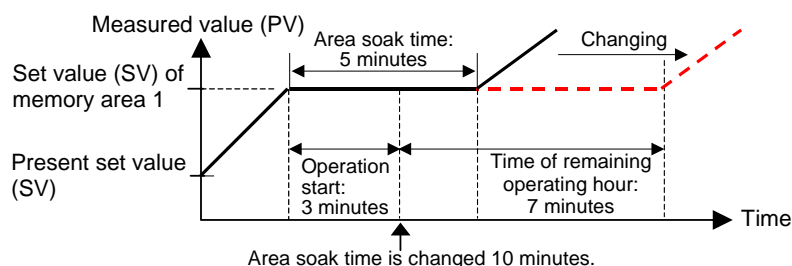



## Link area number

LnEA

Memory area numbers for linking the corresponding memory areas are set when Ramp/Soak control is performed.

Data range	Factory set value
1 to 8 oFF (oFF): No link	oFF (oFF)

This screen does not appear when the value of Digital input (DI) assignment (Engineering mode) is 6 to 12.

### Related parameter

Setup setting mode:

- Area soak time (P. 7-35)

Engineering mode:

- Soak time unit (P. 7-163)

### ■ Description of function

Link area number is used for Ramp/Soak control function in conjunction with Area soak time and Setting change rate limiter (up/down).

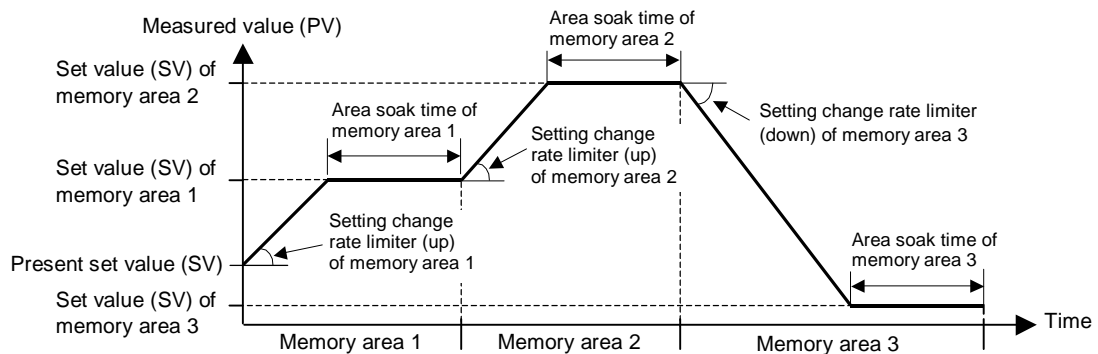

The Area soak time for the memory area linked last becomes invalid to continue the state of the Set value (SV) reached.

## 7.4 Setup Setting Mode

In Setup setting mode, the following operations are possible.

- Change other operation/control related parameters
- Change communication parameters
- Change Data lock level

### 7.4.1 Display sequence

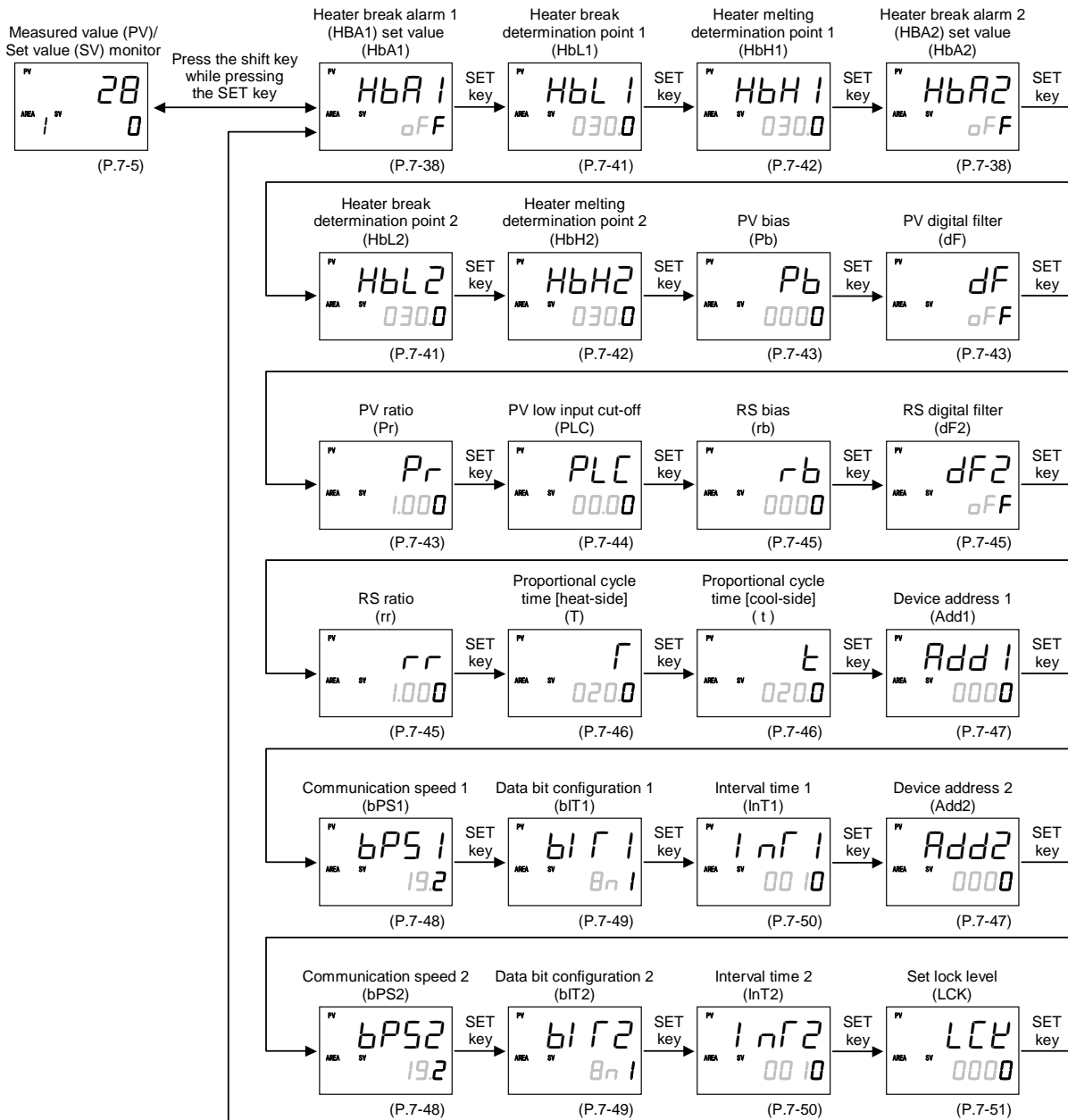

Some parameters may not be displayed when the relevant function is not set so as to be activated or no relevant specification is selected when ordering.



Display returns to the SV setting & monitor mode if no key operation is performed within 1 minute.

## 7.4.2 Setup setting item

### Heater break alarm 1 (HBA1) set value

### Heater break alarm 2 (HBA2) set value

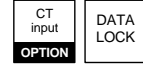

HBA1

HBA2

HBA1 and HBA2 are to set the set values for the Heater break alarm (HBA) function.

Data range	Factory set value
When the CT type is CTL-6-P-N: 0.1 to 30.0 A oFF (oFF): Not used However, the numeric value can be changed up to 100.0.	oFF (oFF)
When the CT type is CTL-12-S56-10L-N: 0.1 to 100.0 A oFF (oFF): Not used	oFF (oFF)

**If either Output 2 (OUT2) as an optional or digital output is not selected, no Heater break alarm is output.**

These screens are not displayed when the CT assignment is set to “0: None.”

#### Related parameters

Setup setting mode:

- Heater break determination point 1, Heater break determination point 2 (P. 7-41)
- Heater melting determination point 1, Heater melting determination point 2 (P. 7-42)

Engineering mode:

- Alarm (ALM) lamp lighting condition 2 (P. 7-84)
- Output status at STOP mode (P. 7-85)
- CT1 ratio (P. 7-112)
- CT2 ratio (P. 7-116)
- CT1 assignment (P. 7-113)
- CT2 assignment (P. 7-117)
- Heater break alarm 1 (HBA1) type (P. 7-113)
- Heater break alarm 2 (HBA2) type (P. 7-118)
- Number of heater break alarm 1 (HBA1) delay times (P.7-115)
- Number of heater break alarm 2 (HBA2) delay times (P. 7-118)

### ■ For the setting of the heater break alarm

The HBA function detects a fault in the heating circuit by monitoring the current flowing through the load by a dedicated Current transformer (CT). Up to two Heater break alarms are available with the controller. CT input 1 is for HBA1, and CT input 2 for HBA2. CT input can be assigned to one output from OUT1 or OUT2. To use HBA for a three-phase load, both CT inputs can be assigned to the same output.

Continued on the next page.

Continued from the previous page.

Two types of Heater break alarms, type A and type B, are available. An appropriate type should be selected depending on the application. (Please refer to “Heater break alarm function” below.)

These parameters, HBA set values (HbA1 and HbA2) are used for both types. However, each type has different function and care must be used to set an appropriate set value.

For type A HBA,

- Set the set value to approximately 85% of the maximum reading of the CT input.
- Set the set value to a slightly smaller value to prevent a false alarm if the power supply may become unstable.
- When more than one heater is connected in parallel, it may be necessary to increase the HBA set value to detect a single heater failure.

For type B HBA,

Set the set value to the maximum CT input value. This will be the current when the control is at 100 % control output. The set value is used to compute the width of a non-alarm range.

## ■ Description of function

### < Heater break alarm (HBA) type A >

Heater break alarm (HBA) type A can be used with time-proportional control output (Relay contact, Voltage pulse, Triac or Open-collector output). The HBA function monitors the current flowing through the load by a dedicated Current transformer (CT), compares the measured value with the HBA set values, and detects a fault in the heating circuit.

Low or no current flow (Heater break, malfunction of the control device, etc.):

When the control output is ON and the CT input value is equal to or less than the Heater break determination point for the preset number of consecutive sampling cycles, an alarm is activated.

Over current or short-circuit:

When the control output is OFF and the CT input value is equal to or greater than the Heater break determination point for the preset number of consecutive sampling cycles, an alarm is activated.

### < Heater break alarm (HBA) type B >

Heater break alarm (HBA) type B can be used with continuous control output (Voltage/Current continuous output). The HBA function assumes that the heater current value is proportional\* to the control output value of the controller, otherwise viewed as the Manipulated output value (MV), and compare it with the CT input value to detect a fault in the heating or cooling circuit.

\* It is assumed that the current value flowing through the load is at maximum when the control output from the controller is 100 %, and the minimum current value flowing through the load is zero (0) when the control output from the controller is 0 %.

Continued on the next page.

Continued from the previous page.

Low or no current flow (Heater break, malfunction of the control device, etc.)

The alarm determination point (Low) is computed as follows:

$$[\text{Non-alarm range (Low) width}] = (\text{HbL1 or HbL2}) \times (\text{HbA1 or HbA2})$$

$$[\text{Alarm determination point (Low)}] = [(\text{HbA1 or HbA2}) \times (\text{MV1 or MV2})] - [\text{Non-alarm range (Low) width}]$$

When the CT input value is equal to or less than the Heater break determination point for the preset number of consecutive sampling cycles, an alarm status is produced.

Over current or short-circuit

The alarm determination point (High) is computed as follows:

$$[\text{Non-alarm range (High) width}] = (\text{HbH1 or HbH2}) \times (\text{HbA1 or HbA2})$$

$$[\text{Alarm determination point (High)}] = [(\text{HbA1 or HbA2}) \times (\text{MV1 or MV2})] + [\text{Non-alarm range (High) width}]$$

When the CT input value is equal to or greater than the Heater melting determination point for the preset number of consecutive sampling cycles, an alarm status is produced.

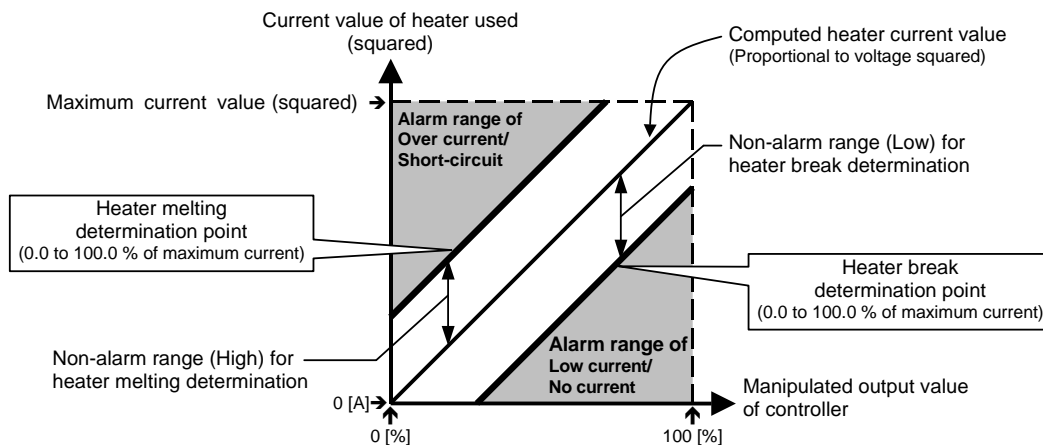

**The current factory set values of HbLs and HbHs are set to 30.0 %. If any of the following conditions exists, set them to a slightly larger value to prevent a false alarm.**

- **Heater current values is not proportional to the control output in phase control.**
- **There is difference on control output accuracy between the controller and the operating unit (SCR power controller).**
- **There is a delay on control output between the controller and the operating unit (SCR power controller).**



Factory set value of Heater break alarm (HBA) varies with the control output type of CT assignment.

- Factory set value (CT assignment: OUT1) of Heater break alarm 1 (HBA1) type:
  - OUT1 output type: Time-proportional control output \*: Type A
  - Continuous control output \*: Type B
- Factory set value (CT assignment: None) of Heater break alarm 2 (HBA2) type: Type A

\* Time-proportional control output: Relay contact, Voltage pulse, Triac or Open-collector output  
 Continuous control output: Voltage/Current continuous output

## Heater break determination point 1

## Heater break determination point 2



HbL 1

HbL 2

Set the Heater break determination point for the Heater break alarm (HBA) type B.

Data range	Factory set value
Heater break determination point 1: 0.1 to 100.0 % of Heater break alarm 1 (HBA1) set value OFF (oFF): Heater break determination is invalid	30.0
Heater break determination point 2: 0.1 to 100.0 % of Heater break alarm 2 (HBA2) set value OFF (oFF): Heater break determination is invalid	30.0

The Heater break determination point 1 or 2 screen is not displayed when CT assignment is set to “0: None.”

The Heater break determination point 1 or 2 screen is displayed when the Heater break alarm type is type B.

### Related parameters

Setup setting mode:

- Heater break alarm 1 (HBA1) set value,  
Heater break alarm 2 (HBA2) set value (P. 7-38)
- Heater melting determination point 1,  
Heater melting determination point 2 (P. 7-42)

Engineering mode:

- CT1 assignment (P. 7-113)
- CT2 assignment (P. 7-117)
- Heater break alarm 1 (HBA1) type (P. 7-113)
- Heater break alarm 2 (HBA2) type (P. 7-118)
- Number of heater break alarm 1 (HBA1) delay times (P. 7-115)
- Number of heater break alarm 2 (HBA2) delay times (P. 7-118)

For the function description, refer to the **Heater break alarm 1 (HBA1) set value/Heater break alarm 2 (HBA2) set value (P. 7-38)**.

## Heater melting determination point 1

## Heater melting determination point 2



HbH1

HbH2

Set the Heater melting determination point for the Heater break alarm (HBA) type B.

Data range	Factory set value
Heater melting determination point 1: 0.1 to 100.0 % of Heater break alarm 1 (HBA1) set value oFF (oFF): Heater melting determination is invalid	30.0
Heater melting determination point 2: 0.1 to 100.0 % of Heater break alarm 2 (HBA2) set value oFF (oFF): Heater melting determination is invalid	30.0

The Heater melting determination point 1 or 2 screen is not displayed when CT assignment is set to “0: None.”

The Heater melting determination point 1 or 2 screen is displayed when the Heater break alarm type is type B.

### Related parameters

Setup setting mode:

- Heater break alarm 1 (HBA1) set value,  
Heater break alarm 2 (HBA2) set value (P. 7-38)
- Heater break determination point 1,  
Heater break determination point 2 (P. 7-41)

Engineering mode:

- CT1 assignment (P. 7-113)
- CT2 assignment (P. 7-117)
- Heater break alarm 1 (HBA1) type (P. 7-113)
- Heater break alarm 2 (HBA2) type (P. 7-118)
- Number of heater break alarm 1 (HBA1) delay times (P. 7-115)
- Number of heater break alarm 2 (HBA2) delay times (P. 7-118)

For the function description, refer to the **Heater break alarm 1 (HBA1) set value/Heater break alarm 2 (HBA2) set value (P. 7-38)**.



## PV bias

DATA  
LOCK

Pb

PV bias adds bias to the Measured value (PV). The PV bias is used to compensate the individual variations of the sensors or correct the difference between the Measured value (PV) of other instruments.

Data range	Factory set value
–Input span to +Input span Varies with the setting of the Decimal point position (P. 7-73).	0

### Related parameters

Engineering mode:

- Decimal point position (P. 7-73)

## PV digital filter

DATA  
LOCK

dF

This item is the time of the first-order lag filter to eliminate noise against the measured input.

Data range	Factory set value
0.1 to 100.0 seconds oFF: Unused	oFF

## PV ratio

DATA  
LOCK

Pr

PV ratio is a multiplier to be applied to the Measured value (PV). The PV ratio is used to compensate the individual variations of the sensors or correct the difference between the Measured value (PV) of other instruments.

Data range	Factory set value
0.500 to 1.500	1.000

DATA  
LOCK

## PV low input cut-off

PLC

PV low input cut-off is used with Square root extraction function. The Measured value less than the PV low input cut-off is ignored to prevent control disturbance caused by input variation at Low measured value range.

Data range	Factory set value
0.00 to 25.00 % of input span	0.00



This screen is displayed when the Square root extraction is set to "1: Used."

### Related parameter

Engineering mode:

- Square root extraction (P. 7-77)

### ■ Description of function

When input signal square root extraction is used for in flow control, etc., the Square root extraction result varies widely at the Low measured value range. The Measured value less than the PV low input cut-off is ignored to compute control output in order to prevent control disturbance caused by input variation at Low measured value range.

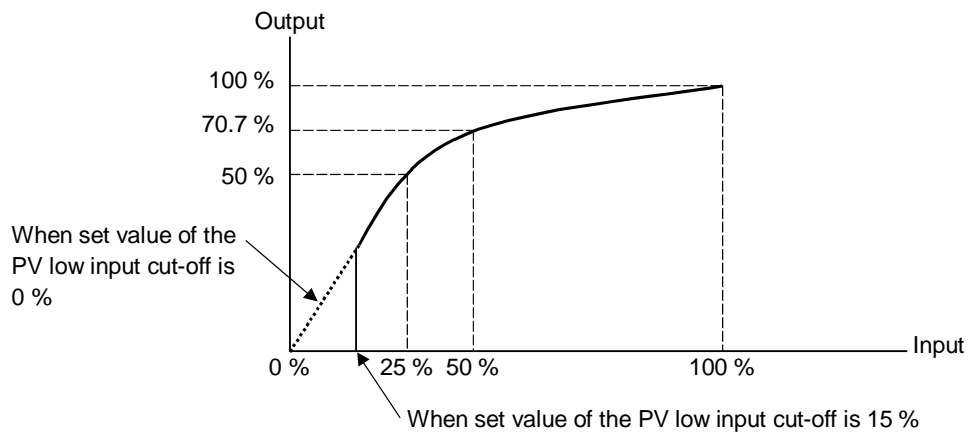



## RS bias



rb

RS bias adds bias to the Remote setting (RS) input value.

Data range	Factory set value
-Input span to +Input span Varies with the setting of the Decimal point position (P. 7-73).	0

-  If the Intercontroller communication control, the RS bias is used as a cascade bias.
-  If the Intercontroller communication control, the RS bias is used as a ratio setting bias.
-  The RS bias screen is displayed when the Remote setting (RS) input or Communication function is provided.

### Related parameters

Engineering mode:

- Decimal point position (P. 7-73)



## RS digital filter



df2

This item is the time of the first-order lag filter to eliminate noise against the remote setting input.

Data range	Factory set value
0.1 to 100.0 seconds oFF: Unused	oFF

-  If the Intercontroller communication control, the RS digital filter is used as a cascade digital filter.
-  If the Intercontroller communication control, the RS digital filter is used as a ratio setting digital filter.
-  The RS digital filter screen is displayed when the Remote setting (RS) input or Communication function is provided.



## RS ratio



rr

RS ratio is a multiplier to be applied to the Remote setting (RS) input value.

Data range	Factory set value
0.001 to 9.999	1.000

-  If the Intercontroller communication control, the RS ratio is used as a cascade ratio.
-  If the Intercontroller communication control, the RS ratio is used as a ratio setting ratio.
-  The RS ratio screen is displayed when the Remote setting (RS) input or Communication function is provided.

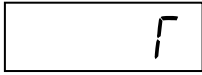
DATA  
LOCK**Proportional cycle time [heat-side]**

Proportional cycle time is to set control cycle time for time based control output such as voltage pulse for SSR, triac, relay and open-collector output.

When in Heat/Cool PID control, it becomes the Proportional cycle time on the heat-side.

Data range	Factory set value
0.1 to 100.0 seconds	Relay contact output (M): 20.0
	Voltage pulse output (V), Triac output (T) and Open-collector output (D): 2.0



This screen is not displayed when the output 1 (OUT1) is Voltage/Current output.

DATA  
LOCK**Proportional cycle time [cool-side]**

This is a Proportional cycle time of cool-side in the Heat/Cool PID control.

Proportional cycle time [cool-side] is to set control cycle time for time based control output such as Voltage pulse for SSR, Triac, Relay contact and Open-collector output.

Data range	Factory set value
0.1 to 100.0 seconds	Relay contact output (M): 20.0
	Voltage pulse output (V), Triac output (T) and Open-collector output (D): 2.0



This screen is displayed when in Heat/Cool PID control.



This screen is not displayed when the output 2 (OUT2) is Voltage/Current output.

## Device address 1

## Device address 2



Add 1







Add 2

Device address 1: Device address 1 is used to set the slave address of the controller for Communication 1 function.

Device address 2: Device address 2 is used to set the slave address of the controller for Communication 2 function.

Device address 2 is also used for the address setting when the Intercontroller communication function is used.

Data range	Factory set value
0 to 99	0

-  **Do not use the same device address for more than one controller in multi-drop connection. Each controller must have a unique address in multi-drop connection.**
-  **When using the Intercontroller communication function, set Device address 2 to any number in the range of 0 to 31. In addition, always set the address of each controller to the number in succession starting from 0.**
-  **In Modbus communication, two-way communication is not possible when the address is 0.**
-  The Device address 1 screen is displayed when the Communication 1 (optional function E, F, G, H or J) is provided.  
The Device address 2 screen is displayed when the Communication 2 (optional function G) is provided.
-  In optional functions E, F, H, and J, Device address 1 is also used for the address setting when the Intercontroller communication function is used.  
In optional function G, Device address 2 is also used for the address setting when the Intercontroller communication function is used.
-  For details of the Intercontroller communication function, refer to **6.14 Group Operation by the Intercontroller Communication (P. 6-61)**.
-  For details of the Communication function, refer to separate **FB100/FB400/FB900 Communication Instruction Manual (IMR01W04-E□)**.

## Communication speed 1

## Communication speed 2



bPS1

bPS2

Communication speed 1: Communication speed 1 is to set communication speed for Communication 1 function.

Communication speed 2: Communication speed 2 is to set communication speed for Communication 2 function.

Data range	Factory set value
2.4: 2400 bps	19.2
4.8: 4800 bps	
9.6: 9600 bps	
19.2: 19200 bps	
38.4: 38400 bps	

The Communication speed 1 screen is displayed when the Communication 1 (optional function E, F, G, H or J) is provided. The Communication speed 2 screen is displayed when the Communication 2 (optional function G) is provided.

When Intercontroller communication (P. 7-162) is selected for the protocol of communication 1, the Communication speed 1 screen does not appear. When Intercontroller communication (P. 7-162) is selected for the protocol of communication 2, the Communication speed 2 screen does not appear.

For details of the Communication function, refer to the separate **FB100/FB400/FB900 Communication Instruction Manual (IMR01W04-E□)**.

## Data bit configuration 1

## Data bit configuration 2



bit 1

bit 2

Data bit configuration 1:

This item is Data bit configuration of Communication 1 function.

Data bit configuration 2:

This item is Data bit configuration of Communication 2 function.

Set value	Data bit configuration			Modbus Communication	RKC Communication
	Data	Stop	Parity		
8n1	8	1	Without	Selectable	Selectable
8n2	8	2	Without		
8E1	8	1	Even		
8E2	8	2	Even		
8o1	8	1	Odd		
8o2	8	2	Odd		
7n1	7	1	Without	Invalid	
7n2	7	2	Without		
7E1	7	1	Even		
7E2	7	2	Even		
7o1	7	1	Odd		
7o2	7	2	Odd		

Factory set value: 8n1 (Data bit: 8, Stop bit: 1, Parity bit: Without)



The Data bit configuration 1 screen is displayed when the Communication 1 (optional function E, F, G, H or J) is provided.

The Data bit configuration 2 screen is displayed when the Communication 2 (optional function G) is provided.



When Intercontroller communication (P. 7-162) is selected for the protocol of communication 1, the Data bit configuration 1 screen does not appear.

When Intercontroller communication (P. 7-162) is selected for the protocol of communication 2, the Data bit configuration 2 screen does not appear.



For details of the Communication function, refer to the separate **FB100/FB400/FB900 Communication Instruction Manual (IMR01W04-E□)**.

## Interval time 1

## Interval time 2



Interval time 1: This item is Interval time of Communication 1 function.

Interval time 2: This item is Interval time of Communication 2 function.

Data range	Factory set value
0 to 250 ms	10

- The Interval time 1 screen is displayed when the Communication 1 (optional function E, F, G, H or J) is provided.  
The Interval time 2 screen is displayed when the Communication 2 (optional function G) is provided.
- When Intercontroller communication (P. 7-162) is selected for the protocol of communication 1, the Interval time 1 screen does not appear.  
When Intercontroller communication (P. 7-162) is selected for the protocol of communication 2, the Interval time 2 screen does not appear.
- For details of the Communication function, refer to the separate **FB100/FB400/FB900 Communication Instruction Manual (IMR01W04-E□)**.



## Set lock level



The Set lock level restricts parameter setting changes by key operation (Set data lock function).

This function prevents the operation from making errors during operation.

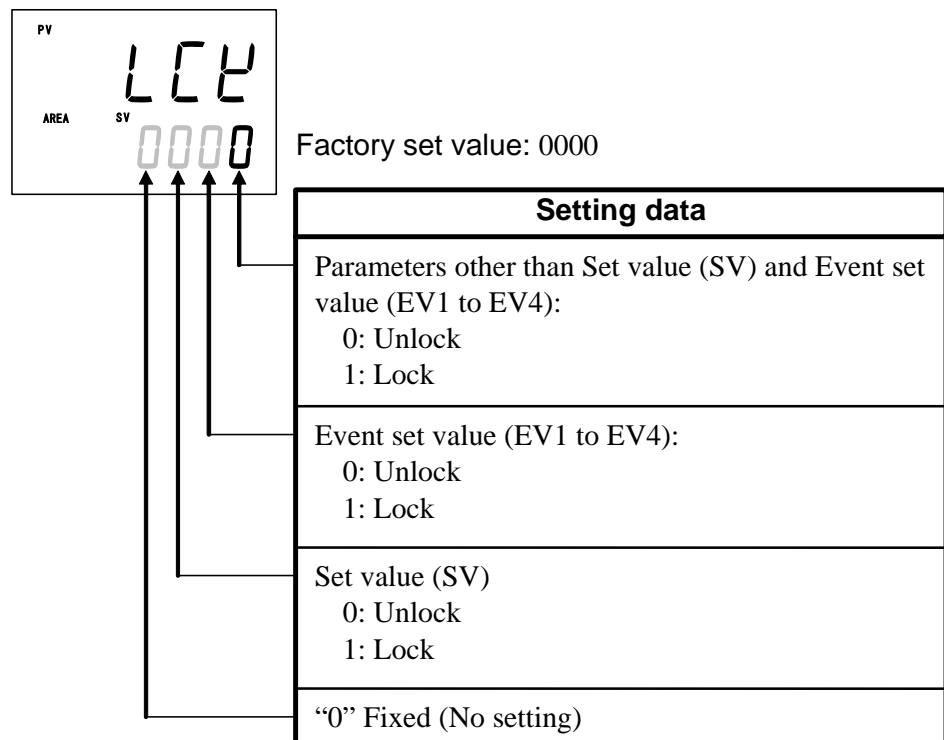

In the Set lock level, data lock is not possible for following parameters.

- Memory area selection (SV setting & monitor mode),
- Parameter of Function block number F10 to F91 (Engineering mode)

Set lock level can be changed in both RUN and STOP mode.



Parameters protected by Data lock function are still displayed for monitoring.

# 7.5 Engineering Mode

The content relating to the specification of this product is set. Set it so as to meet the customer's requirements. For details of the parameter, refer to the **7.5.3 Engineering setting item (P. 7-65)**.

WARNING

Parameters in the Engineering mode should be set according to the application before setting any parameter related to operation. Once the parameters in the Engineering mode are set correctly, no further changes need to be made to parameters for the same application under normal conditions. If they are changed unnecessarily, it may result in malfunction or failure of the instrument. RKC will not bear any responsibility for malfunction or failure as a result of improper changes in the Engineering mode.

-  **Parameters in Engineering mode are settable only when the controller is in STOP mode. However, only checking can be made even in the RUN state.**
-  All parameters of the Engineering mode are displayed regardless of the instrument specification.

## 7.5.1 Display Sequence

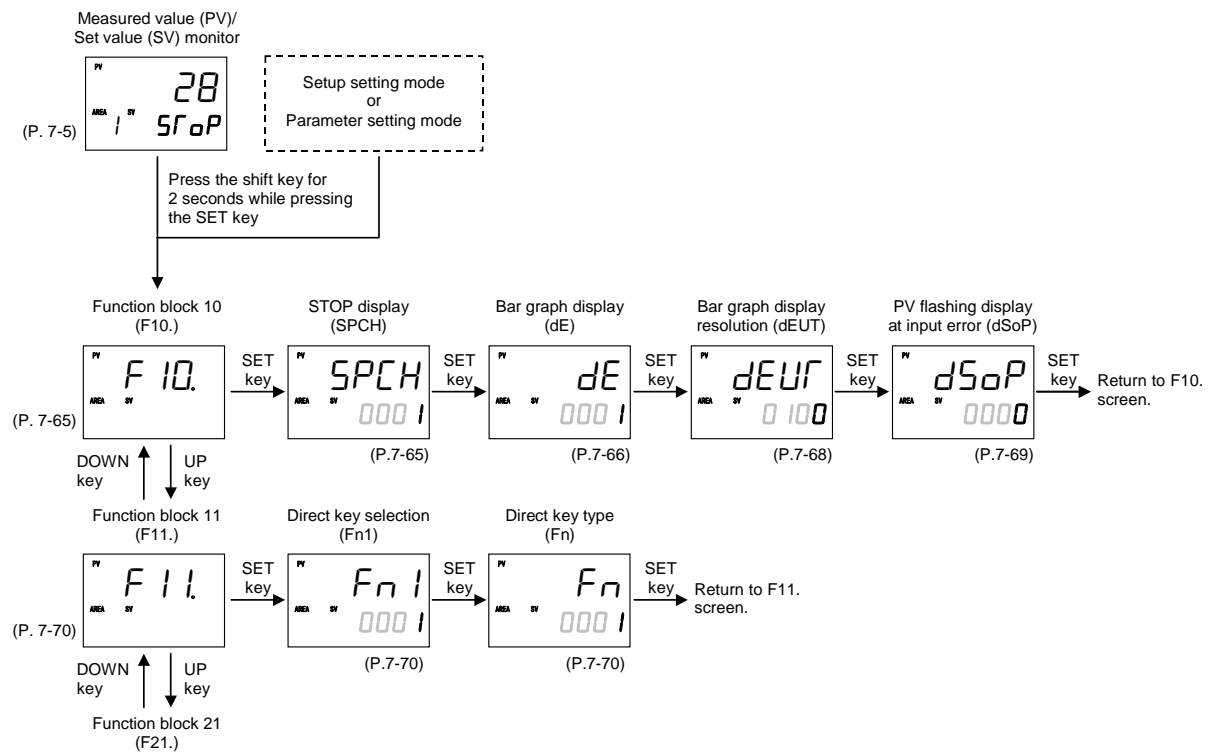

Continued on the next page.

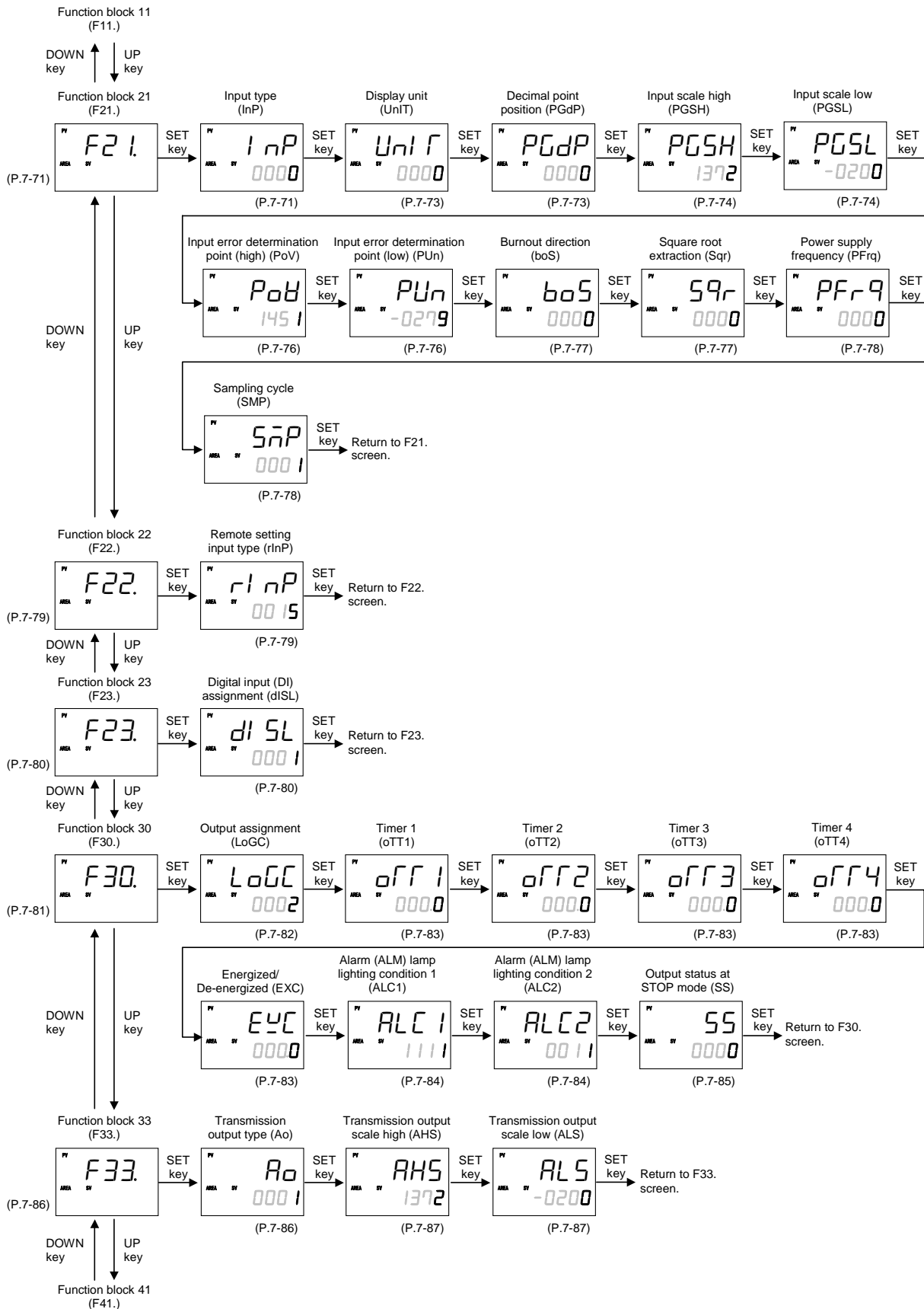

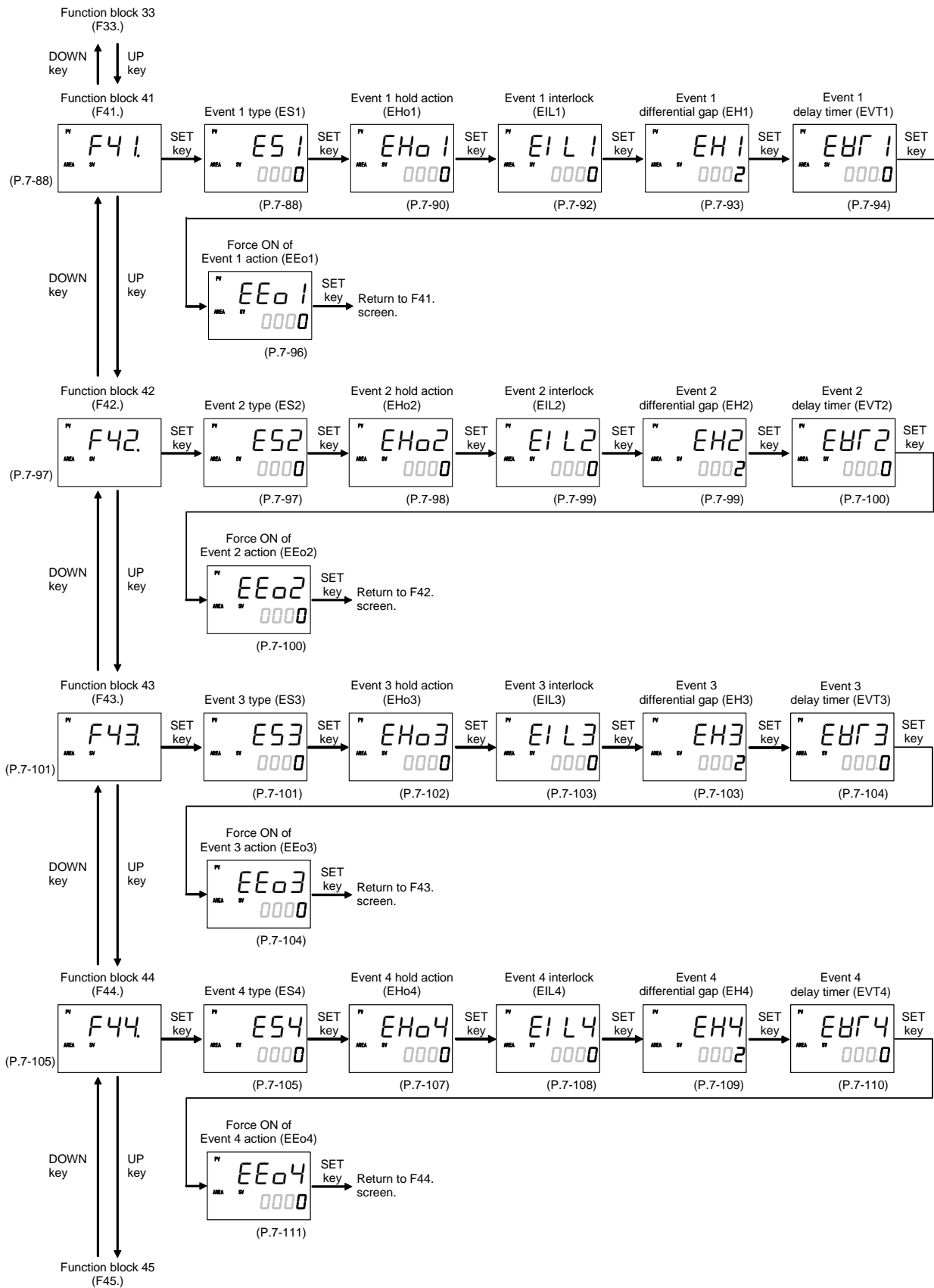

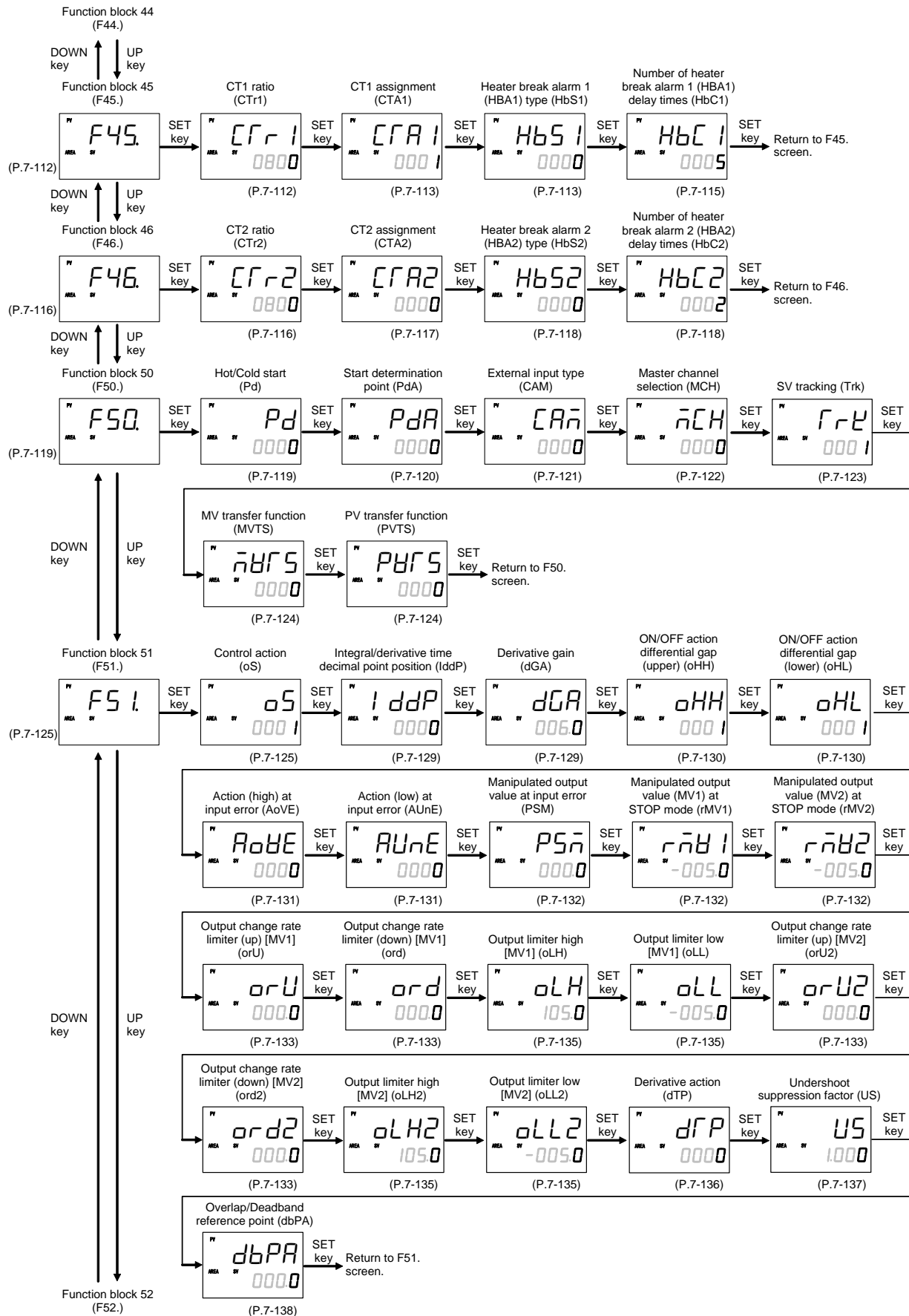

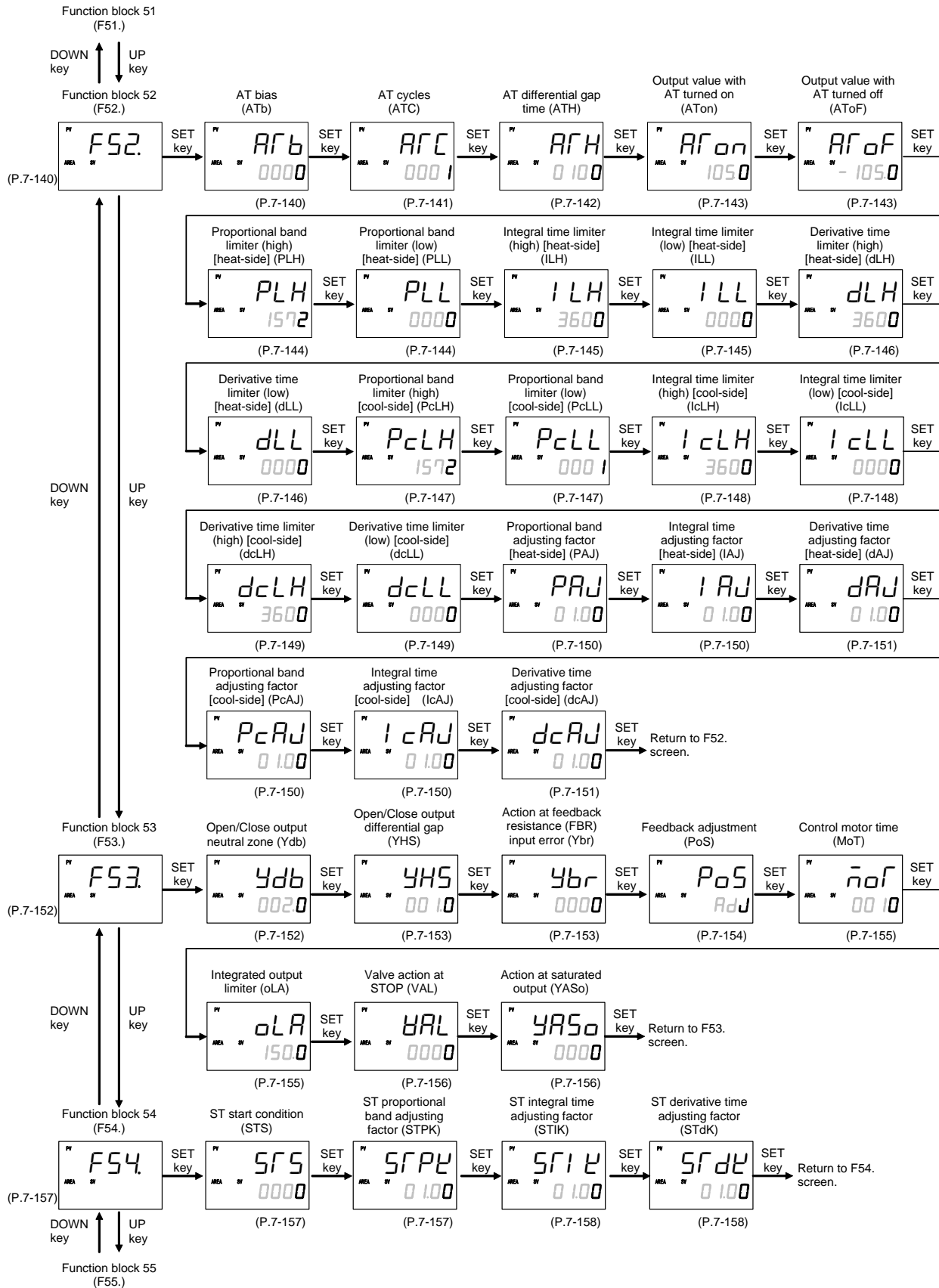

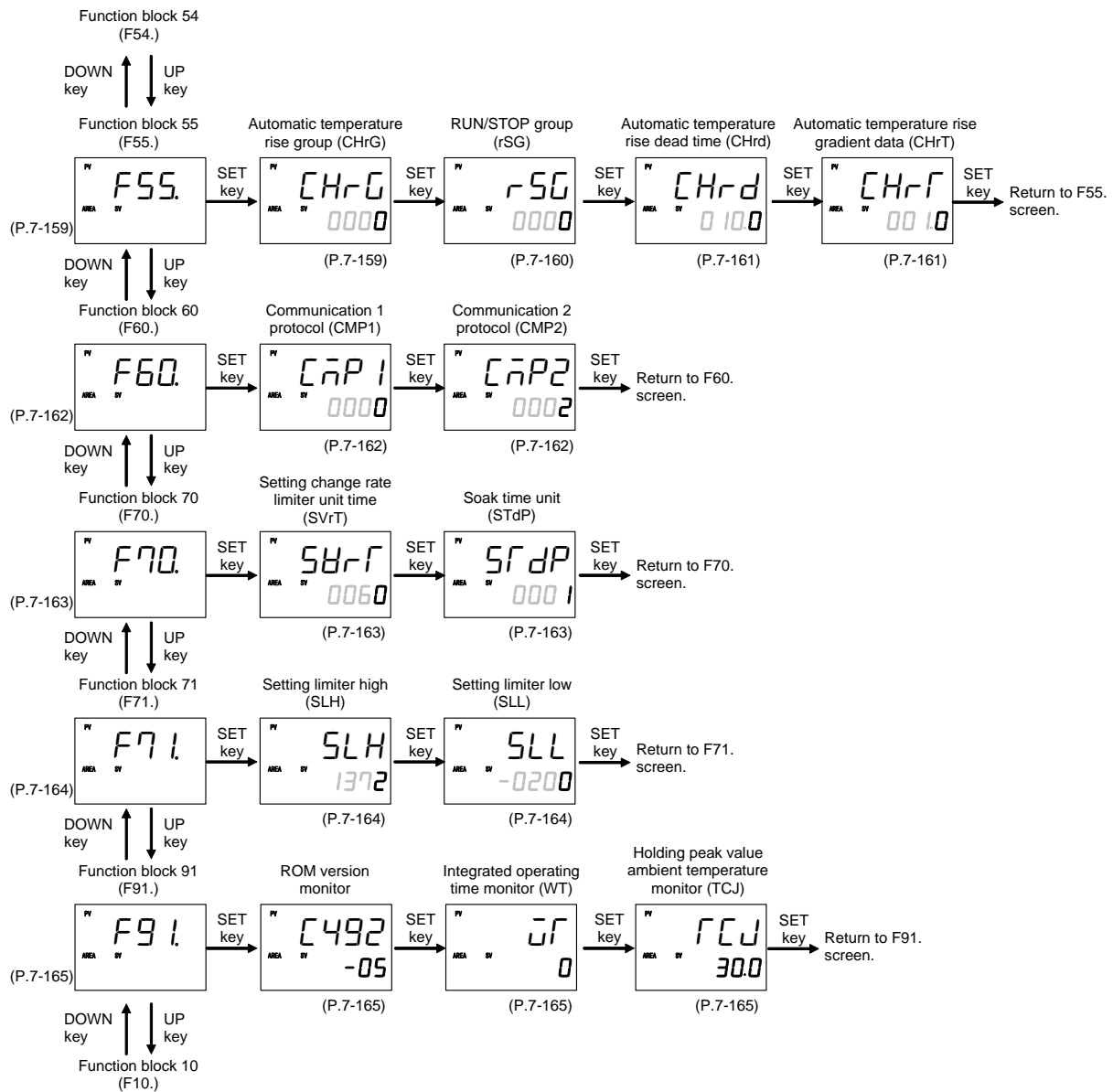

Display returns to the SV setting & monitor mode if no key operation is performed within 1 minute (except during the Feedback adjustment).



To return to the SV setting & monitor mode, press the shift key while pressing the SET key.

## 7.5.2 Precaution against parameter change

If any of the following parameters is changed, the set values of relevant parameters are initialized or is automatically converted according to the new setting. It may result in malfunction or failure of the instrument.

- **Input type (InP) or Display unit (UnIT)**
- **Transmission output type (Ao)**
- **Event 1 type (ES1), Event 2 type (ES2), Event 3 type (ES3) or Event 4 type (ES4)**
- **Control action (oS)**
- **Decimal point position (PGdP)**
- **Integral/Derivative time decimal point position (IddP)**
- **CT1 assignment (CTA1) or CT2 assignment (CTA2)**



**Before changing any parameter setting on the above list, always record all parameter settings in SV setting & monitor mode, Setup setting mode, Parameter setting mode and Engineering mode. And after the change, always check all parameter settings in SV setting & monitor mode, Setup setting mode, Parameter setting mode and Engineering mode by comparing them with the record taken before the change.**

- When any one of the following parameters' settings are changed,

- **Input type (InP)**
- **Display unit (UnIT)**

all parameter settings shown in the table below will be changed to Factory default values according to the new setting. They must be changed according to the application.

Mode	Description	Default value
Engineering mode	Decimal point position	TC/RTD inputs: 0 Voltage (V)/Current (I) inputs: 1
	Input scale high	TC/RTD inputs: Maximum value of the selected input range Voltage (V)/Current (I) inputs: 100.0
	Input scale low	TC/RTD inputs: Minimum value of the selected input range Voltage (V)/Current (I) inputs: 0.0
	Input error determination point (high)	TC/RTD inputs: Input scale high + (5 % of input span) Voltage (V)/Current (I) inputs: +105.0
	Input error determination point (low)	TC/RTD inputs: Input scale low – (5 % of input span) Voltage (V)/Current (I) inputs: –5.0
	Burnout direction	0: Upscale
	Transmission output scale high	PV, Set value (SV) monitor, Set value (SV) or RS input value: Input scale high Manipulated output value (MV1 or MV2): 100.0 % Deviation: +Input span
	Transmission output scale low	PV, Set value (SV) monitor, Set value (SV) or RS input value: Input scale low Manipulated output value (MV1 or MV2): 0.0 % Deviation: –Input span
	Event 1 hold action	0 (Without hold action)
	Event 2 hold action	
	Event 3 hold action	
	Event 4 hold action	
	Event 1 interlock	0 (Unused)
	Event 2 interlock	
Event 3 interlock		
Event 4 interlock		

Continued on the next page.



Continued from the previous page.

Mode	Description	Default value
Engineering mode	Event 1 differential gap	TC/RTD inputs: 2 °C [°F]
	Event 2 differential gap	Voltage (V)/Current (I) inputs: 0.2 % of input span
	Event 3 differential gap	Manipulated output value: 0.2 %
	Event 4 differential gap	
	Event 1 delay timer	0.0 seconds
	Event 2 delay timer	
	Event 3 delay timer	
	Event 4 delay timer	
	Force ON of Event 1 action	0000
	Force ON of Event 2 action	
	Force ON of Event 3 action	
	Force ON of Event 4 action	
	Start determination point	3 % of input span
	ON/OFF action differential gap (upper)	TC/RTD inputs: 1 °C [°F]
	ON/OFF action differential gap (lower)	Voltage (V)/Current (I) inputs: 0.1 % of input span
	AT bias	0
	Proportional band limiter (high) [heat-side]	TC/RTD inputs: Input span Voltage (V)/Current (I) inputs: 1000.0 %
	Proportional band limiter (low) [heat-side]	TC/RTD inputs: 0 °C [°F] Voltage (V)/Current (I) inputs: 0.0 %
	Integral time limiter (high) [heat-side]	1 second setting (No decimal place): 3600 seconds 0.1 seconds setting (One decimal place): 1999.9 seconds
	Integral time limiter (low) [heat-side]	1 second setting (No decimal place): 0 seconds 0.1 seconds setting (One decimal place): 0.0 seconds
	Derivative time limiter (high) [heat-side]	1 second setting (No decimal place): 3600 seconds 0.1 seconds setting (One decimal place): 1999.9 seconds
	Derivative time limiter (low) [heat-side]	1 second setting (No decimal place): 0 seconds 0.1 seconds setting (One decimal place): 0.0 seconds
	Proportional band limiter (high) [cool-side]	TC/RTD inputs: Input span Voltage (V)/Current (I) inputs: 1000.0 %
	Proportional band limiter (low) [cool-side]	TC/RTD inputs: 1 °C [°F] Voltage (V)/Current (I) inputs: 0.1 %
	Integral time limiter (high) [cool-side]	1 second setting (No decimal place): 3600 seconds 0.1 seconds setting (One decimal place): 1999.9 seconds
	Integral time limiter (low) [cool-side]	1 second setting (No decimal place): 0 seconds 0.1 seconds setting (One decimal place): 0.0 seconds
	Derivative time limiter (high) [cool-side]	1 second setting (No decimal place): 3600 seconds 0.1 seconds setting (One decimal place): 1999.9 seconds
	Derivative time limiter (low) [cool-side]	1 second setting (No decimal place): 0 seconds 0.1 seconds setting (One decimal place): 0.0 seconds
	Setting limiter high	Input scale high
	Setting limiter low	Input scale low
Setup setting mode	PV bias	0
	PV ratio	1.000
Parameter setting mode	Event 1 set value (EV1)	50 °C [°F]
	Event 2 set value (EV2)	
	Event 3 set value (EV3)	
	Event 4 set value (EV4)	

Continued on the next page.

Continued from the previous page.

Mode	Description	Default value
Parameter setting mode	Control loop break alarm (LBA) time	480 seconds
	LBA deadband	0
	Proportional band [heat-side]	TC/RTD inputs: 30 °C [°F] Voltage (V)/Current (I) inputs: 30.0
	Integral time [heat-side]	240 seconds
	Derivative time [heat-side]	60 seconds
	Control response parameter	PID control, Position proportioning PID control: 0 (Slow) Heat/Cool PID control: 2 (Fast)
	Proportional band [cool-side]	TC/RTD inputs: 30 °C [°F] Voltage (V)/Current (I) inputs: 30.0
	Integral time [cool-side]	240 seconds
	Derivative time [cool-side]	60 seconds
	Overlap/Deadband	TC/RTD inputs: 0 °C [°F] Voltage (V)/Current (I) inputs: 0.0 %
	Setting change rate limiter (up)	oFF: Unused
	Setting change rate limiter (down)	oFF: Unused
SV setting & Monitor mode	Set value (SV)	TC/RTD inputs: 0 °C [°F] Voltage (V)/Current (I) inputs: 0.0 %

■ When the following parameter setting is changed,

- **Transmission output type (Ao)**

all parameter settings shown in the table below will be changed to Factory default values according to the new setting. They must be changed according to the application.

Mode	Description	Default value
Engineering mode	Transmission output scale high	PV, Set value (SV) monitor, Set value (SV) or RS input value: Input scale high Manipulated output value (MV1 or MV2): 100.0 % Deviation: +Input span
	Transmission output scale low	PV, Set value (SV) monitor, Set value (SV) or RS input value: Input scale low Manipulated output value (MV1 or MV2): 0.0 % Deviation: -Input span

■ When any one of the following parameters' setting are changed,

- **Event 1 type (ES1)**                      - **Event 3 type (ES3)**

- **Event 2 type (ES2)**                      - **Event 4 type (ES4)**

all parameter settings shown in the table below will be changed to Factory default values according to the new setting. They must be changed according to the application.

Mode	Description	Default value
Engineering mode	Event 1 hold action	0 (Without hold action)
	Event 2 hold action	
	Event 3 hold action	
	Event 4 hold action	

Continued on the next page.

Mode	Description	Default value
Engineering mode	Event 1 interlock	0 (Unused)
	Event 2 interlock	
	Event 3 interlock	
	Event 4 interlock	
	Event 1 differential gap	TC/RTD inputs: 2 °C [°F] Voltage (V)/Current (I) inputs: 0.2 % of input span Manipulated output value: 0.2 %
	Event 2 differential gap	
	Event 3 differential gap	
	Event 4 differential gap	
	Event 1 delay timer	0.0 seconds
	Event 2 delay timer	
	Event 3 delay timer	
	Event 4 delay timer	
	Force ON of Event 1 action	0000
	Force ON of Event 2 action	
Force ON of Event 3 action		
Force ON of Event 4 action		
Parameter setting mode	Event 1 set value (EV1)	50 °C [°F]
	Event 2 set value (EV2)	
	Event 3 set value (EV3)	
	Event 4 set value (EV4)	
	Control loop break alarm (LBA) time	480 seconds
	LBA deadband	0

■ When the following parameter setting is changed,

- **Control action (oS)**

all parameter settings shown in the table below will be changed to Factory default values according to the new setting. They must be changed according to the application.

Mode	Description	Default value
Engineering mode	Undershoot suppression factor	PID control (direct action): 1.000
		PID control (reverse action): 1.000
		Heat/Cool PID control [water cooling]: 0.100
		Heat/Cool PID control [air cooling]: 0.250
		Heat/Cool PID control [Cooling gain linear type]: 1.000
		Position proportioning PID control (reverse action): 1.000
		Position proportioning PID control (direct action): 1.000
Parameter setting mode	Control response parameter	PID control, Position proportioning PID control: 0 (Slow) Heat/Cool PID control: 2 (Fast)

- When the following parameter setting is changed,

- **Decimal point position (PGdP)**

all parameter settings shown in the table below will be automatically converted into the a values to match the new decimal point position as long as the converted values are in the acceptable range of each parameter. They must be check and changed if necessary according to the application.

Mode	Description
Engineering mode	Input scale high
	Input scale low
	Input error determination point (high)
	Input error determination point (low)
	Transmission output scale high <sup>1</sup>
	Transmission output scale low <sup>1</sup>
	Event 1 differential gap <sup>2</sup>
	Event 2 differential gap <sup>2</sup>
	Event 3 differential gap <sup>2</sup>
	Event 4 differential gap <sup>2</sup>
	Start determination point
	ON/OFF action differential gap (upper) <sup>3</sup>
	ON/OFF action differential gap (lower) <sup>3</sup>
	AT bias
	Proportional band limiter (high) [heat-side] <sup>3</sup>
	Proportional band limiter (low) [heat-side] <sup>3</sup>
	Proportional band limiter (high) [cool-side] <sup>3</sup>
	Proportional band limiter (low) [cool-side] <sup>3</sup>
	Setting limiter high
	Setting limiter low
Setup setting mode	PV bias
	RS bias
Parameter setting mode	Event 1 set value (EV1) <sup>2</sup>
	Event 2 set value (EV2) <sup>2</sup>
	Event 3 set value (EV3) <sup>2</sup>
	Event 4 set value (EV4) <sup>2</sup>
	LBA deadband
	Proportional band [heat-side] <sup>3</sup>
	Proportional band [cool-side] <sup>3</sup>
	Overlap/Deadband <sup>3</sup>
	Setting change rate limiter (up)
	Setting change rate limiter (down)
	SV setting & Monitor mode
Set value (SV) monitor	
Set value (SV)	
Remote setting (RS) input value	

<sup>1</sup> Only for Measured value (PV), Set value (SV) monitor, Set value (SV) or Remote setting (RS) input value

<sup>2</sup> Only for deviation, input value or set value

<sup>3</sup> Only for thermocouple (TC) or RTD inputs

### Precaution and Example of automatic conversion

- Decimal point position moves in accordance with the setting change.

**Example: When the setting of the Decimal point position is changed from 0 (no decimal place) to 1 (one decimal place) with Input scale high (PGSH) set to 800 °C:**

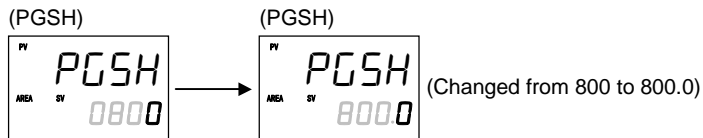

The display will change from 800 to 800.0.

- If the position of the decimal point is set to any digit exceeding the input range, limited the maximum or minimum value of each input type.

**Example: When RTD input is selected for Input type (InP), and Input scale low (PGSL) is -200 °C, the Decimal point position is changed from 1 to 2:**

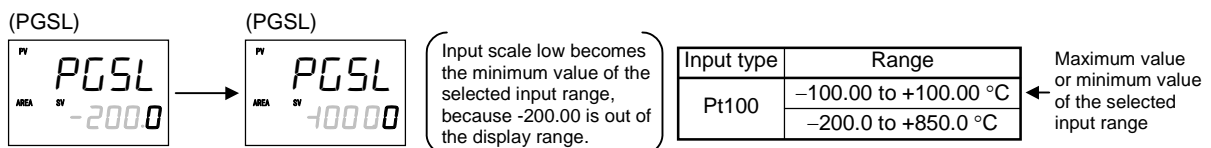

- When a number of decimal places for the set value is reduced due to the decimal point change, the set value is rounded off to the first decimal place and will be displayed without any decimal place.

**Example: When the Decimal point position is changed from 1 (one decimal place) to 0 (no decimal place) and Input scale high (PGSH) is 849.9:**

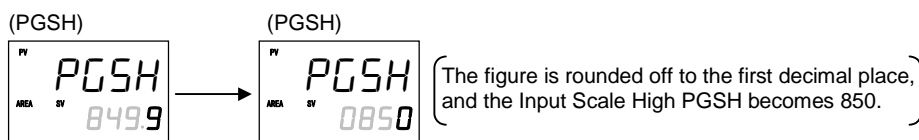

- When the following parameter setting is changed,

- **Integral/Derivative time decimal point position (IddP)**

all parameter settings shown in the table below will be automatically converted into the a values to match the new decimal point position as long as the converted values are in the acceptable range of each parameter. They must be check and changed if necessary according to the application.

Mode	Description
Engineering mode	Integral time limiter (high) [heat-side]
	Integral time limiter (low) [heat-side]
	Derivative time limiter (high) [heat-side]
	Derivative time limiter (low) [heat-side]
	Integral time limiter (high) [cool-side]
	Integral time limiter (low) [cool-side]
	Derivative time limiter (high) [cool-side]
	Derivative time limiter (low) [cool-side]
Parameter setting mode	Integral time [heat-side]
	Derivative time [heat-side]
	Integral time [cool-side]
	Derivative time [cool-side]

## 7.5.3 Engineering setting item

### Function block 10 (F10.)

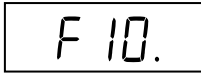

This is the first parameter symbol of Function block 10 (F10.).

F10.

### STOP display







STOP message for control STOP mode can be displayed either on the upper display or the lower display.

SPCH is to select the display to show the STOP message.

Data range	Factory set value
0: Displays on the Measured value (PV) unit	1
1: Displays on the Set value (SV) unit	

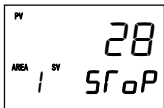
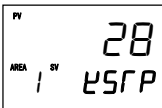
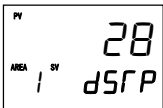
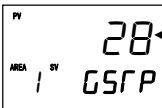
#### ■ Description of function

There are four different characters for STOP mode depending on how to be transferred from RUN to STOP.

	(SToP)	(KSTP)	(dSTP)	(GSTP)	
The SToP is displayed on the SV display.					When the control was stopped, the measured value (PV) can be checked.
	(SToP)	(KSTP)	(dSTP)	(GSTP)	
The SToP is displayed on the PV display.					When the control was stopped, the set value (SV) can be checked.



For the differences in the STOP (control stop) state, refer to **6.14.3 Group RUN/STOP function (P. 6-64)**.

F10.

**Bar graph display**

CT input
OPTION



Use to select the contents of the bar graph display.

Data range	Factory set value
0: No display	1
1: Manipulated output value (MV)	
2: Measured value (PV)	
3: Set value (SV) monitor	
4: Deviation value	
5: Current transformer 1 (CT1) input value	
6: Current transformer 2 (CT2) input value	

Number of display dots

10 dots

Related parameter

Engineering mode:

- Bar graph display resolution (P. 7-68)

**■ Description of function**

Bar graph display explanation:

(1) Manipulated output value (MV)

Displays the Manipulated output value (MV). When Manipulated output value (MV) is at 0 % or less, the left-end dot of the bar-graph flashes. When MV exceeds 100 %, the right-end dot flashes.

[Display example]      0%                      50%                      100%



When the control action is the Heat/Cool PID control:

When both of 'OUT1' and 'OUT2' are lit (when overlapped), the bar graph displays the Manipulated output value (MV1) [heat-side].



When the control action is the Position proportioning PID control:

[With FBR input]

Displays the FBR input value (0.0 to 100.0 %).

[Without FBR input]

Cannot be used as a bar graph. The bar graph displays the over-scaled state (an output of more than 100 %).

[Display example]      0%                      50%                      100%

the left-end dot of the bar-graph flashes.

In this case, it is recommended to be set to "0: No display."



**(2) Measured value (PV)**

Displays the Measured value (PV). Scaling is available within the input range.

[Display example]      0                      50                      100  

**(3) Set value (SV) monitor**

Displays the Set value (SV). Scaling is available within the input range.

Displays the remote set value when the Operation mode is remote mode.

[Display example]      0 °C                      50 °C                      100 °C  

**(4) Deviation value**

Displays the deviation between the Measured value (PV) and the Set value (SV).

When the Deviation display is selected, the dots at both ends of bar-graph light.

A display resolution per dot is settable from 1 to 100.

The display resolution can be set in the Bar graph display resolution (dEUT). (Refer to P. 7-68)

[Display example]      -                      0                      +  

**(5) Current transformer 1 (CT1) input value or Current transformer 2 (CT2) input value**

Displays the input value (current value) of CT1 or CT2.

A display resolution per dot is settable from 1 to 100.

The display resolution can be set in the Bar graph display resolution (dEUT). (Refer to P. 7-68)

[Display example]      0.0 A                      15.0 A                      30.0 A  

F10.

**Bar graph display resolution**

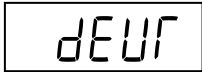

Use to set the bar graph display resolution for the deviation, Current transformer 1 (CT1) or Current transformer 2 (CT2) display. Set several digits per 1 dot of the bar graph.

Data range	Factory set value
1 to 100 digit/dot	100

Related parameter

Engineering mode:

- Bar graph display (P. 7-66)

■ **Display resolution setting example of deviation value**

Condition: Bar graph display resolution setting: 10 digit/dot

- When the input range is the 1 °C [°F] unit

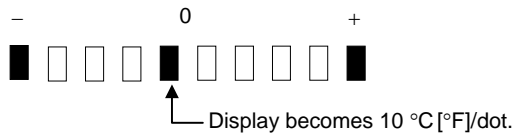

- When the input range is the 0.1 °C [°F] unit

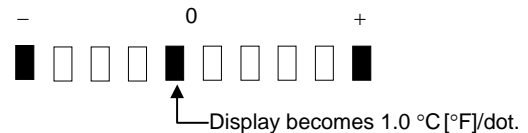

■ **Display resolution setting example of CT1**

Condition: Current transformer type: CTL-6-P-N (0.0 to 30.0 A)

Bar graph display resolution setting: 100 digit/dot

Bar graph display range becomes 0.0 to 30.0 A.

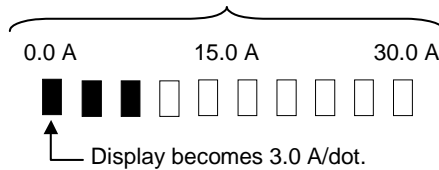

Display resolution and Bar graph display range

Current transformer type	Bar graph resolution setting		
	1 digit/dot	10 digit/dot	100 digit/dot
CTL-6-P-N (0.0 to 30.0 A)	Per 1 dot: 0.03 A/dot ----- Bar graph display range: 0.0 to 0.3 A	Per 1 dot: 0.3 A/dot ----- Bar graph display range: 0.0 to 3.0 A	Per 1 dot: 3.0 A/dot ----- Bar graph display range: 0.0 to 30.0 A
CTL-12-S56-10L-N (0.0 to 100.0 A)	Per 1 dot: 0.1 A/dot ----- Bar graph display range: 0.0 to 1.0 A	Per 1 dot: 1.0 A/dot ----- Bar graph display range: 0.0 to 10.0 A	Per 1 dot: 10.0 A/dot ----- Bar graph display range: 0.0 to 100.0 A

F10.

## PV flashing display at input error

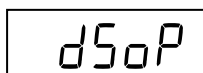

It can be so set that the PV display does not flash if not required. The Measured value (PV) of this instrument flashes in the range of an “5 % of input span” if exceeding the input range.

Data range	Factory set value
0: Flashing display	0
1: Non-flashing display	

### ■ Example: When set to non-flashing display in the range of $-200.0$ to $+800.0$ °C

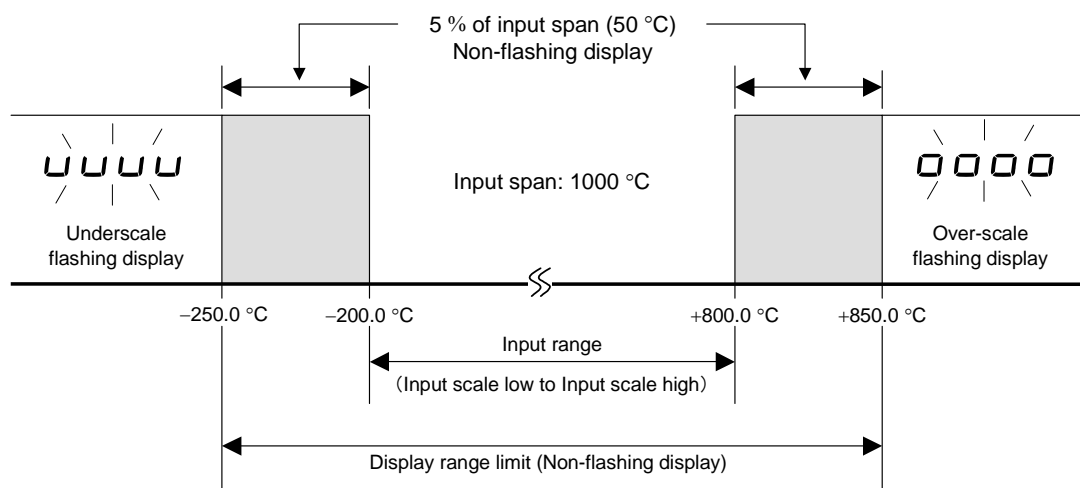

However, if the Input error determination point (low) or the Input error determination point (high) is set within the input range, up to  $\pm 5$  % of input span from the Input error determination point (low) or (high) becomes the PV flashing display range.

---

## Function block 11 (F11.)

---

F11.
------

This is the first parameter symbol of Function block 11 (F11.)

F11.

### Direct key selection

---

Fn1
-----

Use to select Use/Unuse of Direct key.

Data range	Factory set value
0: Unused	1
1: Used	

Related parameter

Engineering mode:

- Direct key type (P. 7-70)

F11.

### Direct key type

---

Fn
----

Use to select the type of Direct key.

Data range	Factory set value
1: Auto/Manual transfer 2: Monitor 3: Memory are transfer 4: Remote/Local transfer 5: RUN/STOP transfer	1

Related parameter

Engineering mode:

- Direct key selection (P. 7-70)

## Function block 21 (F21.)



This is the first parameter symbol of Function block 21 (F21.).

F21.

### Input type

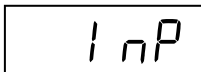

Data range: 0 to 26 (refer to the following table)



**A measured input is a universal input but requires hardware selection (of a Voltage (low) or (high) input group). The input select switch enables hardware selection. (Refer to next page.)**

Data range	Hardware	Factory set value
0: TC input K 1: TC input J 2: TC input R 3: TC input S 4: TC input B 5: TC input E 6: TC input N 7: TC input T 8: TC input W5Re/W26Re 9: TC input PLII 10: TC input U 11: TC input L 12: RTD input Pt100 13: RTD input JPt100 14: Current input 0 to 20 mA DC 15: Current input 4 to 20 mA DC 19: Voltage (low) input 0 to 1 V DC 20: Voltage (low) input 0 to 100 mV DC 21: Voltage (low) input 0 to 10 mV DC 25: Voltage (low) input $\pm 100$ mV DC 26: Voltage (low) input $\pm 10$ mV DC	Voltage (low) input group	If no input range code is specified: 0  If the input type is specified by the model and suffix code when ordering, that input type becomes the factory set value.
16: Voltage (high) input 0 to 10 V DC 17: Voltage (high) input 0 to 5 V DC 18: Voltage (high) input 1 to 5 V DC 24: Voltage (high) input $\pm 1$ V DC	Voltage (high) input group	



**Do not set to any number (including 22 and 23) which is not described in the input range table above. This may cause malfunctioning.**

Continued on the next page.

Continued from the previous page.



As the Decimal point position, Input scale high and Input scale low are initialized if the input type is changed, it is necessary to conduct the re-setting. A value of “3 % of input span” is automatically set at the Start determination point.

For the parameters which will be initialized if the input type is changed, refer to **7.5.2 Precaution against parameter change (P. 7-58)**.

#### Related parameters

Engineering mode:

- Display unit (P. 7-73)
- Decimal point position (P. 7-73)
- Input scale high, Input scale low (P. 7-74)

#### ■ Hardware selection

The Voltage (low) or (high) input group is selected by the input select switch (for Measured input) at the side of the instrument. Turn the Measured input switch by a small screwdriver.

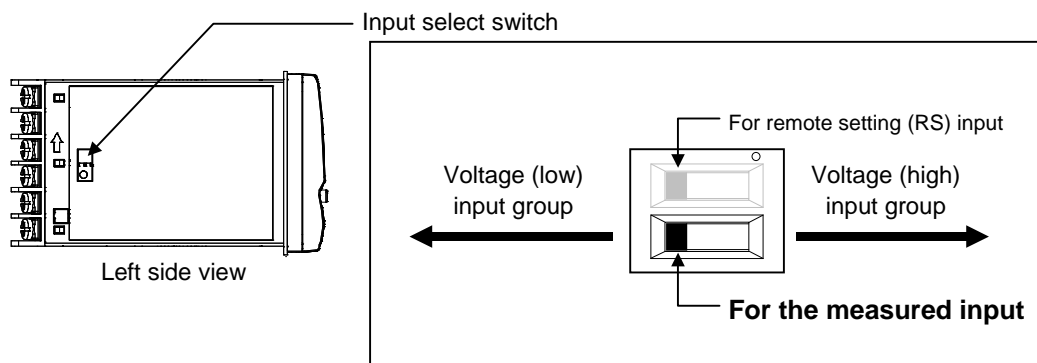

F21.

**Display unit**

Unit

Use to select the temperature unit for Thermocouple (TC) and RTD inputs.

Data range	Factory set value
0: °C 1: °F	If no input range code is specified: 0  If the Display unit type is specified by the model and suffix code when ordering, that Display unit becomes the factory set value.



The invalidity in case of the Voltage/Current inputs.

F21.

**Decimal point position**

PCDP

Use to select the Decimal point position of the input range.

Data range	Factory set value
0: No decimal place 1: One decimal place 2: Two decimal places 3: Three decimal places 4: Four decimal places  TC input:   K, J, E:   Only 0 or 1 can be set. T, U, L:   Only 1 can be set. Other than the above: Only 0 can be set. RTD input:               From 0 to 2 can be set. Voltage (V)/Current (I) inputs: From 0 to 4 can be set.	If no input range code is specified: 0  If the Decimal point position is specified by the model and suffix code when ordering, that Decimal point position becomes the factory set value.

**Related parameters**

Engineering mode:

- Input type (P. 7-71)
- Input scale high, Input scale low (P. 7-74)

F21.

**Input scale high****Input scale low**

PUSH

PSL

Use to set the high limit and low limit of the input scale range.

Data range	Factory set value
Input scale high TC/RTD inputs: Input scale low to Maximum value of the selected input range Varies with the setting of the Decimal point position (P. 7-73).	Maximum value of the selected input range
Voltage (V)/Current (I) inputs: -19999 to +19999 Varies with the setting of the Decimal point position (P. 7-73).	100.0
Input scale low TC/RTD inputs: Minimum value of the selected input range to Input scale high Varies with the setting of the Decimal point position (P. 7-73).	Minimum value of the selected input range
Voltage (V)/Current (I) inputs: -19999 to +19999 Varies with the setting of the Decimal point position (P. 7-73).	0.0



When a Voltage (V)/Current (I) input type is selected, the input scale high limit can be set lower than the input scale low limit.  
(Input scale high limit < Input scale low limit)

**Related parameters**

Engineering mode:

- Input type (P. 7-71)
- Decimal point position (P. 7-73)

**■ Description of function**

The input range can be changed for temperature input (TC/RTD).

For Voltage (V)/Current (I) input, display scaling can be made in the range of -19999 to +19999.

Example (temperature input): When the range of -200.0 to +800.0 °C for Thermocouple Type K is changed to 0.0 to 400.0 °C

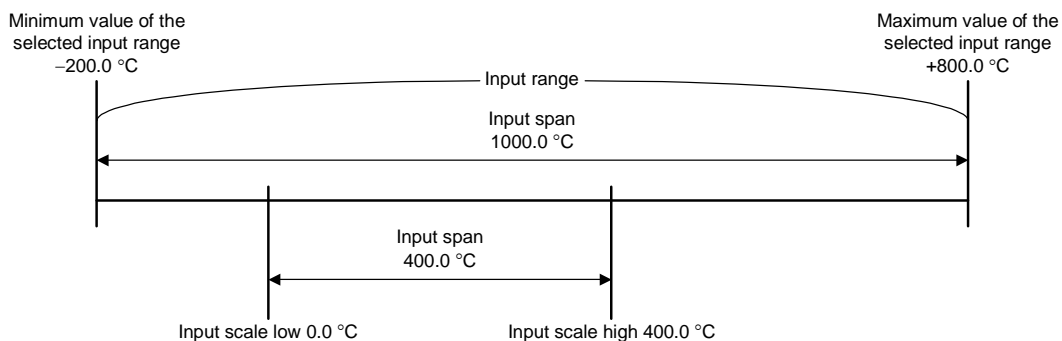

**When the scale for temperature input is changed, it is recommended to be changed within the input range. If any value exceeding the input range is set, input resolution may vary.**



If the Input scale high or low limit is changed, a value of “3 % of input span” is automatically set at the Start determination point.



Example [Voltage (V)/Current (I) inputs]:

When the input scale is changed to “0.0 to 50.0” from “0.0 to 100.0” at a voltage input of 1 to 5 V DC

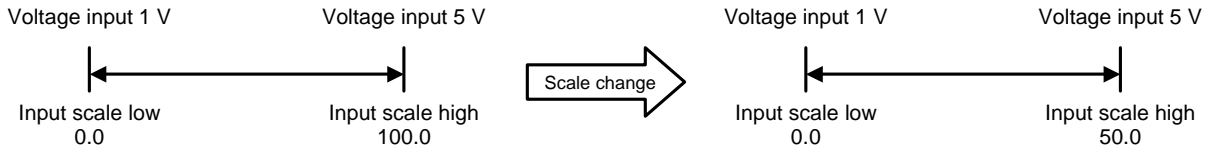

Table 1: Input range table

Input type		Data range		Hardware	
TC input	K	-200.0 to +400.0 °C	-328.0 to +400.0 °F	Voltage (low) input group	
		-200.0 to +800.0 °C	-250.0 to +800.0 °F		
		-200 to +1372 °C	-328 to +2502 °F		
	J	0.0 to 400.0 °C	-200.0 to +700.0 °F		
		-200.0 to +400.0 °C	-328.0 to +1200 °F		
		-200.0 to +800.0 °C	-328 to +2192 °F		
			-200 to +1200 °C		
	T	-200.0 to +400.0 °C	-328.0 to +752.0 °F		
	S	-50 to +1768 °C	-58 to +3214 °F		
	R	-50 to +1768 °C	-58 to +3214 °F		
	E	-200.0 to +700.0 °C	-328.0 to +1292.0 °F		
		-200 to +1000 °C	-328 to +1832 °F		
	B	0 to 1800 °C	0 to 3272 °F		
N	0 to 1300 °C	0 to 2372 °F			
PLII	0 to 1390 °C	0 to 2534 °F			
W5Re/W26Re	0 to 2300 °C	0 to 4200 °F			
U	0.0 to 600.0 °C	32.0 to 1112.0 °F			
L	0.0 to 900.0 °C	32.0 to 1652.0 °F			
RTD input	Pt100	-100.00 to +100.00 °C	-199.99 to +199.99 °F		
		-200.0 to +850.0 °C	-328.0 to +1562.0 °F		
	JPt100	-100.00 to +100.00 °C	-199.99 to +199.99 °F		
		-200.0 to +640.0 °C	-328.0 to +1184.0 °F		
Current input	0 to 20 mA DC 4 to 20 mA DC	Programmable range -19999 to +19999 (The decimal point position of the input range is selectable.)		Voltage (high) input group	
Voltage (low) input	0 to 1 V DC				
	0 to 100 mV DC				
	0 to 10 mV DC				
	±100 mV DC ±10 mV DC				
Voltage (high) input	0 to 10 V DC				
	0 to 5 V DC				
	1 to 5 V DC				
	±1 V DC				

F21.

**Input error determination point (high)**

**Input error determination point (low)**

PoH

PUn

If the Measured value (PV) is above the Input error determination point (high) or below the Input error determination point (low), Action (high) at input error or Action (low) at input error will be taken.

Data range	Factory set value
Input error determination point (high) Input scale low – (5 % of input span) to Input scale high + (5 % of input span) Varies with the setting of the Decimal point position (P. 7-73).	TC/RTD inputs: Input scale high + (5 % of input span) Voltage (V)/Current (I) inputs: 105.0
Input error determination point (low) Input scale low – (5 % of input span) to Input scale high + (5 % of input span) Varies with the setting of the Decimal point position (P. 7-73).	TC/RTD inputs: Input scale low – (5 % of input span) Voltage (V)/Current (I) inputs: –5.0

**Related parameters**

Engineering mode:

- Decimal point position (P. 7-73)
- Action (high) at input error, Action (low) at input error (P. 7-131)
- Manipulated output value at input error (P. 7-132)

**■ Example: When the input scale range is –200 to +1372 °C**

Input span: 1572  
 5 % of input span: 79 (78.6 was rounded off)  
 Setting range: –279 to +1451 °C

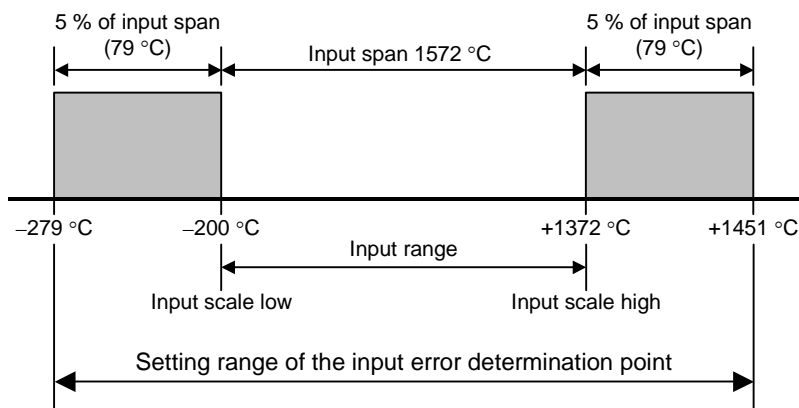

F21.

**Burnout direction**

Use to select Burnout direction in input break. When input break is detected by the controller, the measured value go either Upscale or Downscale according to the Burnout direction setting.

Data range	Factory set value
0: Upscale 1: Downscale	0



The Burnout direction setting are effective only for Thermocouple input and Voltage (low) input.



For the following types of input, the action when an input break occurs is fixed, regardless of the Burnout direction setting.

RTD input: Upscale

Voltage (high) input: Downscale (display of about 0 V)

Current input: Downscale (display of about 0 mA)

F21.

**Square root extraction**

Use to select Use/Unuse of the Square root extraction for the measured value.

Data range	Factory set value
0: Unused 1: Used	0

Related parameter

Setup setting mode:

- PV low input cut-off (P. 7-44)

**■ Description of function**

The controller can receive the input signal directly from a differential pressure type flow transmitter by using Square root extraction function without using a square root extractor.

F21.

**Power supply frequency**

PF-9

Use to select the Power supply frequency of the controller suited to the application. If the display on the screen flickers, set the value to the same value as the power frequency used.

Data range	Factory set value
0: 50 Hz 1: 60 Hz	0



No power frequency can be changed while it can be normally measured with the Current transformer (CT) input provided.

F21.

**Sampling cycle**

SAP

This is a sampling time when measured input is captured.

Data range	Factory set value
0: 50 ms 1: 100 ms 2: 250 ms	1

## Function block 22 (F22.)

F22.

This is the first parameter symbol of Function block 22 (F22.).

F22.

### Remote setting input type

RS  
input  
OPTION

r1 nP

Data range: 14 to 21 (refer to the following table)



**Remote setting (RS) input requires hardware selection (of a Voltage (low) or (high) input group). The input select switch enables hardware selection.**

Data range	Hardware	Factory set value
14: Current input 0 to 20 mA DC 15: Current input 4 to 20 mA DC	Voltage (low) input group	If no Remote setting input type is specified: 15  If the Remote setting input type is specified by model and suffix code when ordering, that Remote setting input type becomes the factory set value.
16: Voltage input 0 to 10 V DC 17: Voltage input 0 to 5 V DC 18: Voltage input 1 to 5 V DC	Voltage (high) input group	
19: Voltage input 0 to 1 V DC 20: Voltage input 0 to 100 mV DC 21: Voltage input 0 to 10 mV DC	Voltage (low) input group	

#### ■ Hardware selection

The Voltage (low) or (high) input group is selected by the input select switch (for Remote setting (RS) input) at the side of the instrument. Turn the Remote setting (RS) input switch by a small screwdriver.

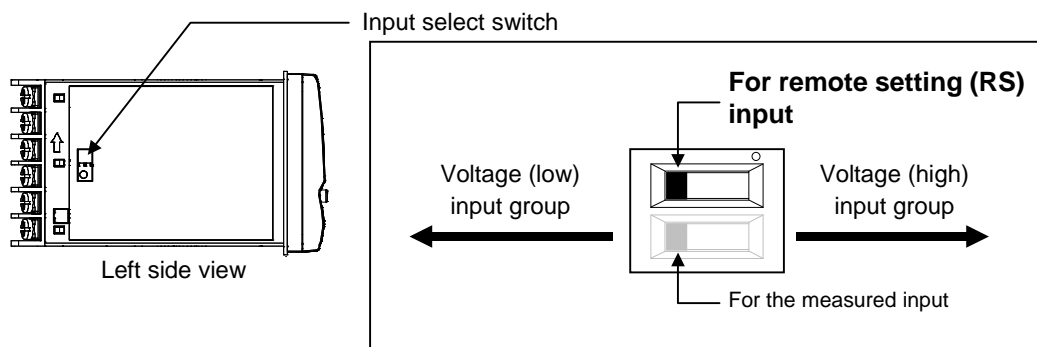

## Function block 23 (F23.)

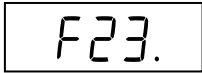

This is the first parameter symbol of Function block 23 (F23.).

F23.

### Digital input (DI) assignment

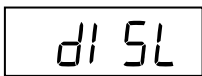
Use to assign the function (Memory area transfer, RUN/STOP transfer, Auto/Manual transfer, Remote/Local transfer or Interlock release) for the Digital inputs (DI 1 to DI 5).

Data range	Factory set value
1 to 26 (For details, refer to the table 1 of next page.)	1  If a Digital input (DI) assignment is specified when the order is placed, the factory set value will be the specified value.

#### Related parameters

SV setting & monitor mode:

- Memory area soak time monitor (P. 7-10)
- Memory area transfer (P. 7-11)

Operation mode:

- Control area Local (LOC)/External (EXT) transfer (P. 7-20)

Parameter setting mode:

- Area soak time (P. 7-35)
- Link area number (P. 7-36)



For Digital input (DI) transfer, refer to following page.

- Memory area number transfer: Refer to **6.9 Control Area Transfer (P. 6-33)**.
- RUN/STOP transfer: Refer to **6.4 RUN/STOP Transfer (P. 6-11)**.
- Remote/Local transfer: Refer to **6.8 Remote/Local Transfer (P. 6-29)**.
- Auto/Manual transfer: Refer to **6.7 Auto/Manual Transfer (P. 6-23)**.
- Interlock release: Refer to **6.10 Interlock Release (P. 6-39)**.

Table 1 Digital input (DI) assignment

Set value	Digital input 1 DI1	Digital input 2 DI2	Digital input 3 DI3	Digital input 4 DI4	Digital input 5 DI5	Selectable optional function
1	Unused	Unused	Unused	Unused	Unused	—
2	Memory area number transfer (1 to 8)			Memory area set	RUN/STOP	A
3	Memory area number transfer (1 to 8)			Memory area set	Unused	
4	Memory area number transfer (1 to 8)			Memory area set	Auto/Manual	
5	Memory area number transfer (1 to 8)			Memory area set	Interlock release	
6	Memory area number transfer (1 to 8)			RUN/STOP	Unused	
7	Memory area number transfer (1 to 8)			RUN/STOP	Auto/Manual	
8	Memory area number transfer (1 to 8)			RUN/STOP	Interlock release	
9	Memory area number transfer (1 to 8)			Unused	Auto/Manual	
10	Memory area number transfer (1 to 8)			Unused	Interlock release	
11	Memory area number transfer (1 to 8)			Auto/Manual	Interlock release	
12	Memory area number transfer (1 to 8)					
13	RUN/STOP	Remote/Local *	Auto/Manual			
14	RUN/STOP	Remote/Local *	Interlock release			
15	RUN/STOP	Auto/Manual	Interlock release			
16	Remote/Local *	Auto/Manual	Interlock release			A, B, C, D, E
17	RUN/STOP	Remote/Local *				
18	RUN/STOP	Auto/Manual				
19	RUN/STOP	Interlock release				
20	Remote/Local *	Auto/Manual				
21	Remote/Local *	Interlock release				
22	Auto/Manual	Interlock release			A, B, C, D, E, F, J, 3, 4, 5, 6, 7, 8	
23	RUN/STOP					
24	Remote/Local *					
25	Auto/Manual					
26	Interlock release					

RUN/STOP: RUN/STOP transfer    Auto/Manual: Auto/Manual transfer    Remote/Local: Remote/Local transfer

Memory area set: When the contact changes from open to closed, transfer to the memory area specified in DI1 to DI3 takes place.

\* For Remote setting input and optional functions without Communication (A, C, D), Remote/Local transfer is not valid.

## Function block 30 (F30.)

**F30.**

This is the first parameter symbol of Function block 30 (F30.).

**F30.**

**Output assignment**

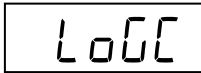

This is used to assign the Output function (Control output, Event output, etc.) for the Output (OUT1 and OUT2) and the Digital output (DO1, DO2).

Data range	Factory set value
1 to 15 (For details, refer to table 1.)	1 If an Output assignment is specified when the order is placed, the factory set value will be the specified value.





**Related parameters**

Engineering mode:

- Energized/De-energized (P. 7-83)
- Alarm (ALM) lamp lighting condition 1 (P. 7-84)
- Alarm (ALM) lamp lighting condition 2 (P. 7-84)
- Event 1 type (P. 7-88)
- Event 2 type (P. 7-97)
- CT1 assignment (P. 7-113)
- CT2 assignment (P. 7-117)
- Event 3 type (P. 7-101)
- Event 4 type (P. 7-105)

Table 1: Output assignment

Set value	Output 1 (OUT1)	Output 2 (OUT2)	Digital output 1 (DO1)	Digital output 2 (DO2)
1	Control output 1	Control output 2	Event 1 output (EV1)	Event 2 output (EV2)
2	Control output 1	Control output 2	Event 1 output (EV1)	Event 4 output (EV4)
3	Control output 1	Control output 2	Event 1 output (EV1)	Heater break alarm (HBA) output
4	Control output 1	Control output 2	Event 1 output (EV1)	FAIL output (de-energized)
5	Control output 1	Control output 2	Event 4 output (EV4)	Heater break alarm (HBA) output
6	Control output 1	Control output 2	Event 4 output (EV4)	FAIL output (de-energized)
7	Control output 1	Control output 2	Heater break alarm (HBA) output	FAIL output (de-energized)
8	Control output 1	Heater break alarm (HBA) output	Event 1 output (EV1)	Event 2 output (EV2)
9	Control output 1	Heater break alarm (HBA) output	Event 1 output (EV1)	Event 4 output (EV4)
10	Control output 1	Heater break alarm (HBA) output	Event 1 output (EV1)	FAIL output (de-energized)
11	Control output 1	Heater break alarm (HBA) output	Event 4 output (EV4)	FAIL output (de-energized)
12	Control output 1	FAIL output (de-energized)	Event 1 output (EV1)	Event 2 output (EV2)
13	Control output 1	FAIL output (de-energized)	Event 1 output (EV1)	Event 4 output (EV4)
14	Control output 1	Event 1 output (EV1)	Event 2 output (EV2)	Event 3 output (EV3)
15	Control output 1	Event 4 output (EV4)	Event 1 output (EV1)	Event 2 output (EV2)

-  For Position proportioning PID control, regardless of the above selection, OUT1 becomes the open-side output, and OUT2 becomes the close-side output.
-  Heater break alarm (HBA) output becomes *OR* output when two Current transformer (CT) inputs are available.
-  With the exception of FAIL, Energized/De-energized switching is possible. The FAIL output is De-energized only; it cannot be changed to Energized. (Factory setting: Energized)
-  To use for Heat/Cool PID control, select a set value from 1 to 7.
-  Outputs and Event functions not specified in the model code is not valid if specified.



F30.

## Timer 1    Timer 3 Timer 2    Timer 4

off1

off2

off3

off4

The customization tool is required for using the Timer 1 to 4 function.  
As this function cannot be used at present, do not change it.

Data range	Factory set value
0.0 to 600.0 seconds	0.0

F30.

## Energized/De-energized

EYC

Use to select the Energized or De-energized for the Digital output (DO1 and DO2).  
However, the FAIL alarm is fixed to De-energized.  
(When at FAIL alarm occurrence: Contact opened)

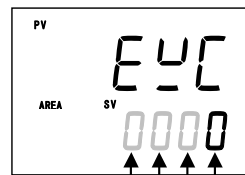

Factory set value: 0000 (energized)

DO1: 0: Energized    1: De-energized

DO2: 0: Energized    1: De-energized

"0" fixed (No setting)

"0" fixed (No setting)

### Related parameters

Engineering mode:

- Output assignment (P. 7-82)
- Event 1 type (P. 7-88)
- Event 2 type (P. 7-97)
- Event 3 type (P. 7-101)
- Event 4 type (P. 7-105)

### ■ Description of function

Energized: Relay contact is closed under the event or alarm status.

De-energized: Relay contact opens under the event or alarm status.

Diagram for explaining operation (At power-ON)

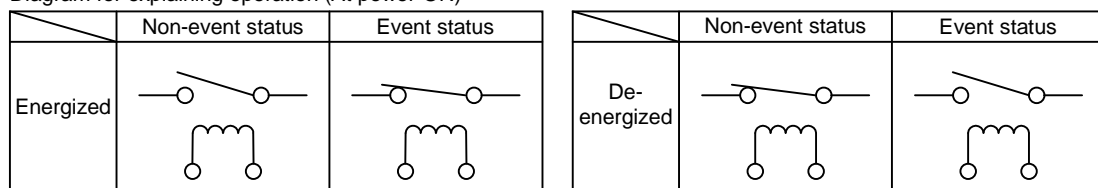

F30.

**Alarm (ALM) lamp lighting condition 1****Alarm (ALM) lamp lighting condition 2**

ALC 1

ALC 2

Use to set an alarm (ALM) lamp lighting conditions to Event 1 to Event 4, HBA1 and HBA2.

The alarm lamp is lit through the *OR* operation of Event 1 to Event 4, HBA1 and HBA2 each of which is set to “1: ALM lamp is lit.”

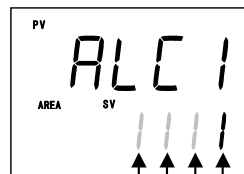

Factory set value: 1111 (ALM lamp is lit)

Event 1 (EV1):	0: ALM lamp is not lit	1: ALM lamp is lit
Event 2 (EV2):	0: ALM lamp is not lit	1: ALM lamp is lit
Event 3 (EV3):	0: ALM lamp is not lit	1: ALM lamp is lit
Event 4 (EV4):	0: ALM lamp is not lit	1: ALM lamp is lit

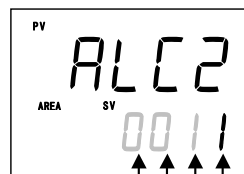

Factory set value: 0011 (ALM lamp is lit)

Heater break alarm 1 (HBA1):	0: ALM lamp is not lit	1: ALM lamp is lit
Heater break alarm 2 (HBA2):	0: ALM lamp is not lit	1: ALM lamp is lit
“0” fixed (No setting)		
“0” fixed (No setting)		

**Related parameters****Engineering mode:**

- Output assignment (P. 7-82)
- Event 1 type (P. 7-88)
- Event 2 type (P. 7-97)
- Event 3 type (P. 7-101)
- Event 4 type (P. 7-105)
- CT1 assignment (P. 7-113)
- CT2 assignment (P. 7-117)

F30.

## Output status at STOP mode

55

It is selected whether or not Event output, Heater break alarm output or Transmission output is continued or turned off when the controller is set to STOP (control stop).

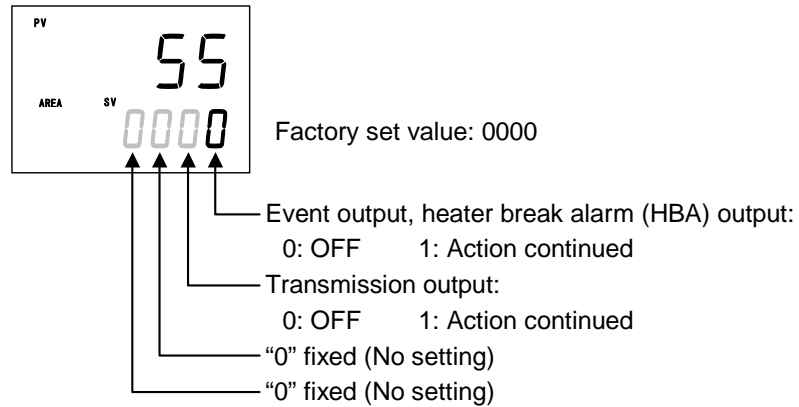

### Related parameters

#### Engineering mode:

- Output assignment (P. 7-82)
- Transmission output type (P. 7-86)
- Event 1 type (P. 7-88)
- Event 2 type (P. 7-97)
- Event 3 type (P. 7-101)
- Event 4 type (P. 7-105)
- CT1 assignment (P. 7-113)
- CT2 assignment (P. 7-117)

## Function block 33 (F33.)

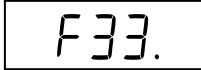

This is the first parameter symbol of Function block 33 (F33.).

**F33.**

### Transmission output type

AO  
OPTION

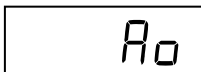

Use to select the transmission output type.

Data range	Factory set value
0: None	1
1: Measured value (PV)	
2: Set value (SV) monitor	
3: Deviation value	
4: Manipulated output value (MV1) [heat-side] *	
5: Manipulated output value (MV2) [cool-side]	
6: Set value (SV)	
7: Remote setting (RS) input value	

\* For Position proportioning PID control: Feedback resistance input value

#### Related parameters

Engineering mode:

- Output status at STOP mode (P. 7-85)
- Transmission output scale high (P. 7-87)
- Transmission output scale low (P. 7-87)

### ■ Description of function

The Transmission output (analog output) is the function of outputting the state of Measured value (PV), Set value (SV), Deviation value, Manipulated output value or Remote setting (RS) input value as a Voltage or Current signal. It is possible to record the state of Measured value (PV) or Set value (SV) when connected to a recorder.

Output types of transmission output:

Voltage output	0 to 1 V DC, 0 to 5 V DC, 0 to 10 V DC, 1 to 5 V DC
Current output	0 to 20 mA DC, 4 to 20 mA DC

F33.

## Transmission output scale high

## Transmission output scale low

AO
OPTION

AHS

ALS

Use to set a scale high limit value or low limit value of the Transmission output.

Data range	Factory set value
When the transmission type is the Measured value (PV), Set value (SV) monitor, Set value (SV) or Remote setting (RS) input value: Input scale low to Input scale high Varies with the setting of the Decimal point position (P. 7-73).	Transmission output scale high: Input scale high  Transmission output scale low: Input scale low
When the transmission type is the deviation value: -Input span to +Input span	
When the transmission type is the Manipulated output value (MV1) or Manipulated output value (MV2): -5.0 to +105.0 %	

 The Decimal point position is the same as Decimal point position (PGdP) of the input.

### Related parameters

Engineering mode:

- Decimal point position (P. 7-73)
- Output status at STOP mode (P. 7-85)
- Transmission output type (P. 7-86)

### ■ Description of function

This is the function of scaling the output range for the content of transmission selected by the Transmission output type (Ao).

Example: If scaling is made under the following conditions

Output signal type: Current output 4 to 20 mA DC  
 Transmission output type (Ao): Measured value (PV)  
 Transmission output scale high (AHS): +1372 °C  
 Transmission output scale low (ALS): -200 °C

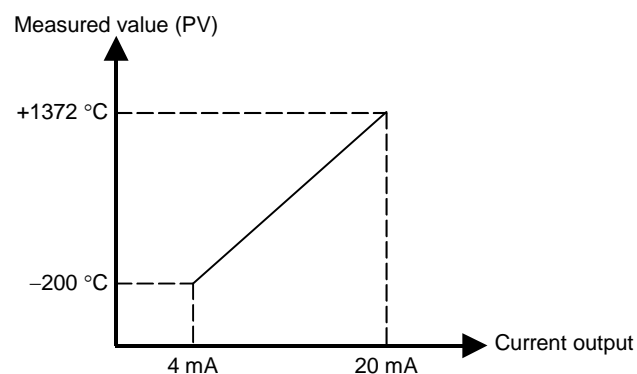

## Function block 41 (F41.)

F41.

This is the first parameter symbol of Function block 41 (F41.).

**F41.**

### Event 1 type

E51

Use to select a action type of the Event 1.

Data range	Factory set value	
0: None	0	
Deviation action: 1: Deviation high <sup>1</sup> 2: Deviation low <sup>1</sup> 3: Deviation high/low <sup>1</sup> 4: Band <sup>1</sup>	If the event type is specified by the model and suffix code when ordering, that event type becomes the factory set value.	
Input value action: 5: Process high <sup>1</sup> 6: Process low <sup>1</sup>		
Set value action: 7: Set value (SV) high 8: Set value (SV) low		
Manipulated output value action: 10: Manipulated output value (MV1) high [heat-side] <sup>1,2</sup> 11: Manipulated output value (MV1) low [heat-side] <sup>1,2</sup> 12: Manipulated output value (MV2) high [cool-side] <sup>1</sup> 13: Manipulated output value (MV2) low [cool-side] <sup>1</sup>		
9: Unused		
Do not set to "9: Unused" for Event 1.		

<sup>1</sup> Event hold action is available.

<sup>2</sup> The Manipulated output value (MV) corresponds to the Feedback resistance (FBR) input value when Feedback resistance (FBR) input is used.

#### Related parameters

Parameter setting mode:

- Event 1 set value (P. 7-24)

Continued on the next page.

Continued from the previous page.

Engineering mode:

- Output assignment (P. 7-82)
- Energized/De-energized (P. 7-83)
- Alarm (ALM) lamp lighting condition 1 (P. 7-84)
- Output status at STOP mode (P. 7-85)
- Event 1 hold action (P. 7-90)
- Event 1 interlock (P. 7-92)
- Event 1 differential gap (P. 7-93)
- Event 1 delay timer (P. 7-94)
- Force ON of Event 1 action (P. 7-96)

## ■ Description of function

Diagrams of the event action type are shown in the following.

ON: Event action turned on

OFF: Event action turned off

(▲ : Set value (SV)   Δ : Event set value   ☆ : Event differential gap)

### Deviation action:

If the Deviation (PV – SV) reaches the Event set value, Event ON occurs.

1: Deviation high (using SV monitor value)

(Event set value is greater than 0.)

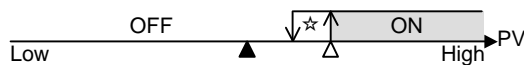

(Event set value is less than 0.)



2: Deviation low (using SV monitor value)

(Event set value is greater than 0.)



(Event set value is less than 0.)

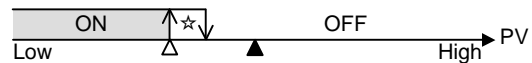

3: Deviation high/low (using SV monitor value)



4: Band (using SV monitor value)



### Input value action:

When the Measured value (PV) reaches the Event set value, Event ON occurs.

5: Process high

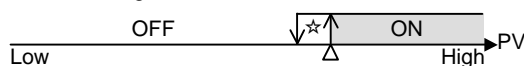

6: Process low

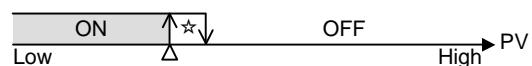

### Set value action:

When the Set value (SV) reaches the Event set value, Event ON occurs.

7: SV high:

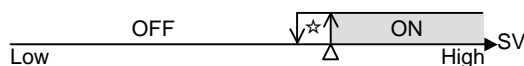

8: SV low:

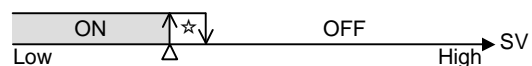

### Manipulated output value action:

When the Manipulated output value (MV) reaches the Event set value, Event ON occurs.

10: MV high [heat-side]

12: MV high [cool-side]

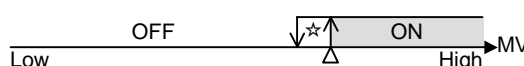

11: MV low [heat-side]

13: MV low [cool-side]

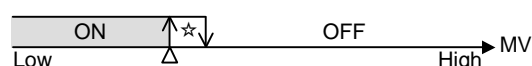

F41.

**Event 1 hold action**

EHo1

Use to set an Event hold action for the Event 1.

Data range	Factory set value
0: OFF	0
1: Hold action ON (Only Hold action) <ul style="list-style-type: none"> <li>• Validate the Hold action when the power is turned on.</li> <li>• Validate the Hold action when transferred from STOP (control STOP) to RUN (control RUN).</li> </ul>	If the event type is specified by the model and suffix code when ordering, the factory set value of Event 1 hold action differs depending on that event type.
2: Re-hold action ON (Hold and Re-hold actions) <ul style="list-style-type: none"> <li>• Validate the Hold action when the power is turned on.</li> <li>• Validate the Hold action when transferred from STOP (control STOP) to RUN (control RUN).</li> <li>• Validate the Re-hold action when the Set value (SV) is changed.</li> </ul> However, if the rate of setting change limiter is set to any function other than "OFF (Unused)" or in the Remote mode, the Re-hold action becomes invalid.	



**When high alarm with Hold/Re-hold action is used for Event function, alarm does not turn on while Hold action is in operation. Use in combination with a high alarm without Hold action in order to prevent overheating which may occur by failure of control devices, such as welding of relays.**

**Related parameters**

Parameter setting mode:

- Event 1 set value (P. 7-24)

Engineering mode:

- Energized/De-energized (P. 7-83)
- Alarm (ALM) lamp lighting condition 1 (P. 7-84)
- Output status at STOP mode (P. 7-85)
- Event 1 type (P. 7-88)
- Event 1 interlock (P. 7-92)
- Event 1 differential gap (P. 7-93)
- Event 1 delay timer (P. 7-94)
- Force ON of Event 1 action (P. 7-96)

**■ Description of function****(1) Hold action**

When Hold action is ON, the event action is suppressed at start-up or STOP to RUN until the Measured value has entered the non-event range.



[With hold action]

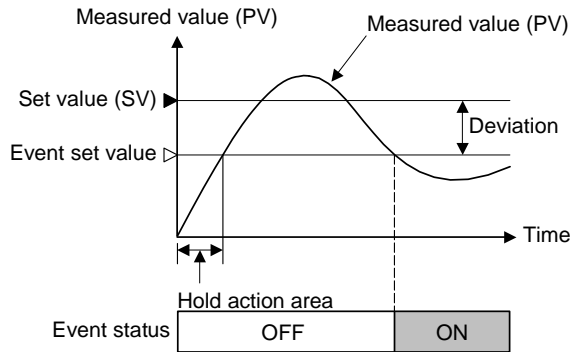

[Without hold action]

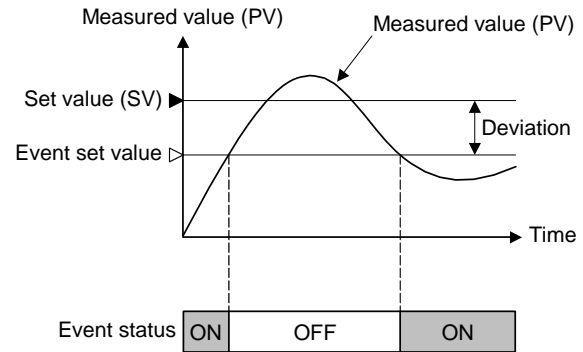

## (2) Re-hold action

When Re-hold action is ON, the event action is also suppressed at the control set value change until the Measured value has entered the non-event range.

Action condition	1: Hold action ON (Only Hold action)	2: Re-hold action ON (Hold and Re-hold actions)
When the power is turned on	Hold action	Hold action
When transferred from STOP (control STOP) to RUN (control RUN)	Hold action	Hold action
When the Set value (SV) is changed	Without Hold and Re-hold actions	Re-hold action



**The Re-hold action is invalid for any of the following. However, the Hold action is valid.**

- When Setting change rate limiter other than “OFF (Unused)” are set
- When Remote/Local transfer is the remote mode

[Example] When Event 1 type is the deviation low:

When Re-hold action is OFF and event output type is deviation, the event output is produced due to the Set value change. The Re-hold action suppresses the alarm output until the Measured value has entered the non-event range again.

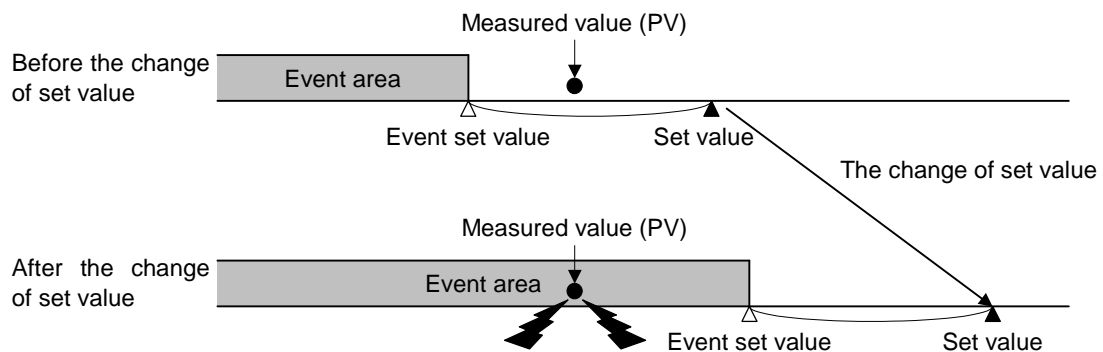

F41.

## Event 1 interlock

E1L1

Use to select the Interlock function for the Event 1.

Data range	Factory set value
0: Unused 1: Used	0

### Related parameters

Parameter setting mode:

- Event 1 set value (P. 7-24)

Engineering mode:

- Energized/De-energized (P. 7-83)
- Alarm (ALM) lamp lighting condition 1 (P. 7-84)
- Output status at STOP mode (P. 7-85)
- Event 1 type (P. 7-88)
- Event 1 hold action (P. 7-90)
- Event 1 differential gap (P. 7-93)
- Event 1 delay timer (P. 7-94)
- Force ON of Event 1 action (P. 7-96)

### ■ Description of function

The Event interlock function is used to hold the event state even if the Measured value (PV) is out of the event area after its entry into the area once.

[Example] When the Event interlock function is used for deviation high

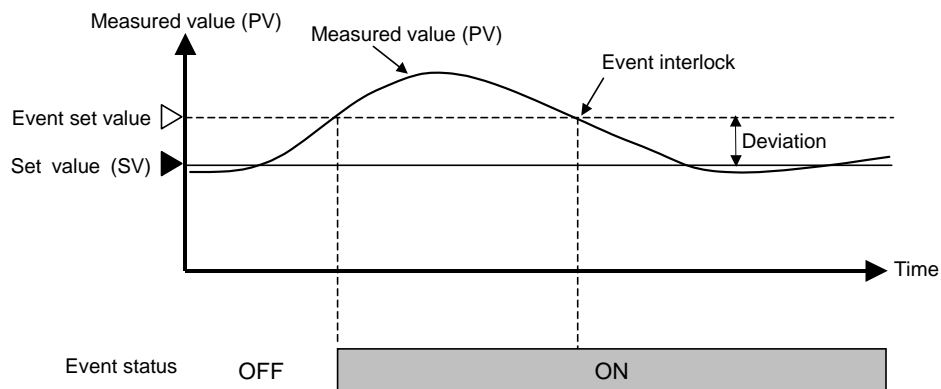

[Without Event hold action]

F41.

## Event 1 differential gap

EH1

Use to set a Differential gap of the Event 1.

Data range	Factory set value
When Event 1 type is deviation, input value or set value actions: 0 to Input span Varies with the setting of the Decimal point position (P. 7-73).	2
When Event 1 type is Manipulated output value action: 0.0 to 110.0 %	If the event type is specified by the model and suffix code when ordering, the factory set value of Event 1 differential gap differs depending on that event type.

### Related parameters

Parameter setting mode:

- Event 1 set value (P. 7-24)

Engineering mode:

- Decimal point position (P. 7-73)
- Energized/De-energized (P. 7-83)
- Alarm (ALM) lamp lighting condition 1 (P. 7-84)
- Output status at STOP mode (P. 7-85)
- Event 1 type (P. 7-88)
- Event 1 hold action (P. 7-90)
- Event 1 interlock (P. 7-92)
- Event 1 delay timer (P. 7-94)
- Force ON of Event 1 action (P. 7-96)

### ■ Description of function

It prevents chattering of event output due to the measured value fluctuation around the Event set value.

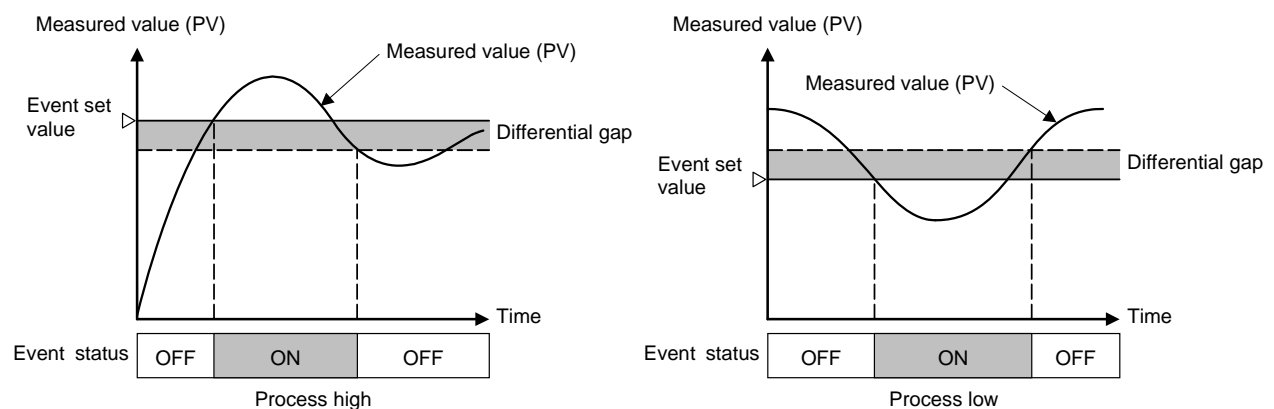

F41.

## Event 1 delay timer



Event 1 delay timer is to set an output delay time for event outputs.

Data range	Factory set value
0.0 to 600.0 seconds	0.0

### Related parameters

Parameter setting mode:

- Event 1 set value (P. 7-24)

Engineering mode:

- Energized/De-energized (P. 7-83)
- Alarm (ALM) lamp lighting condition 1 (P. 7-84)
- Output status at STOP mode (P. 7-85)
- Event 1 type (P. 7-88)
- Event 1 hold action (P. 7-90)
- Event 1 interlock (P. 7-92)
- Event 1 differential gap (P. 7-93)
- Force ON of Event 1 action (P. 7-96)

### ■ Description of function

When an event condition becomes ON status, the output is suppressed until the Delay timer set time elapses. After the time is up, if the event output is still ON status, the output will be produced.

Example: When the setting of Event 1 delay timer is 50.0 seconds

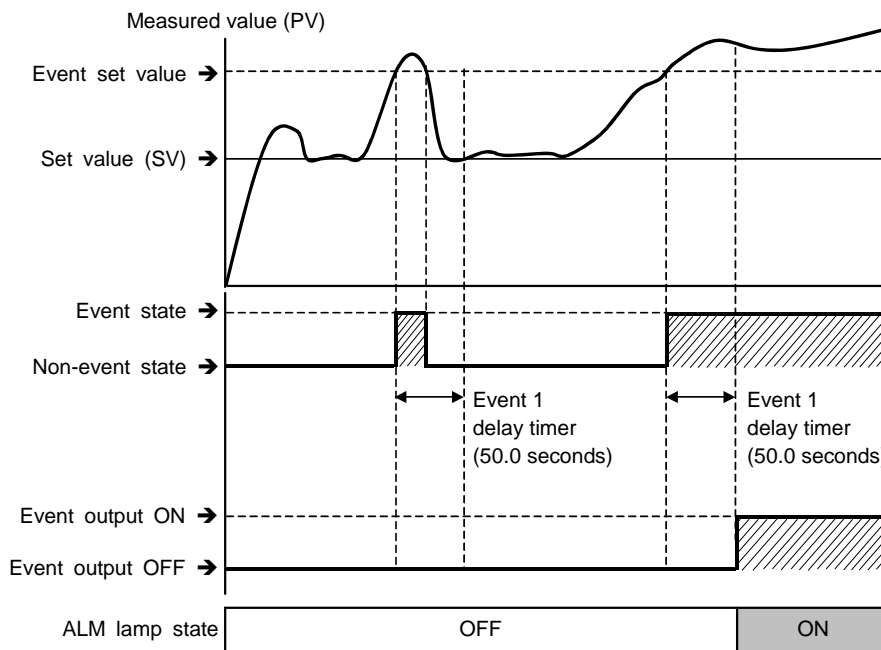

Continued on the next page.

---

Continued from the previous page.



The Event delay timer is also activated for the following cases.

- When set to the event state simultaneously with power turned on
- When set to the event state simultaneously with control changed to RUN (control start) from STOP (control stop).



In the event wait state, no event output is turned on even after the Event delay timer preset time has elapsed.



The Event delay timer is reset for the following cases.

- When power failure occurs while the Event delay timer is being activated
- When control is changed to STOP (control stop) from RUN (control start) while the Event delay timer is being activated

F41.

**Force ON of Event 1 action**

EEo1

Select the operation state that is output (force ON) as the event action.

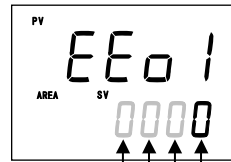

Factory set value: 0000

- Event output turned on at input error occurrence  
0: Invalid      1: Valid
- Event output turned on in manual mode  
0: Invalid      1: Valid
- Event output turned on during the autotuning (AT) function is being executed  
0: Invalid      1: Valid
- Event output turned on during the setting change rate limiter is being operated  
0: Invalid      1: Valid

**Related parameters**

Engineering mode:

- Input error determination point (high),  
Input error determination point (low) (P. 7-76)

**■ Description of function**

Event action at input error:

Example: Input range: 0 to 400 °C  
 Input error determination point (high): 300 °C  
 Input error determination point (low): 50 °C

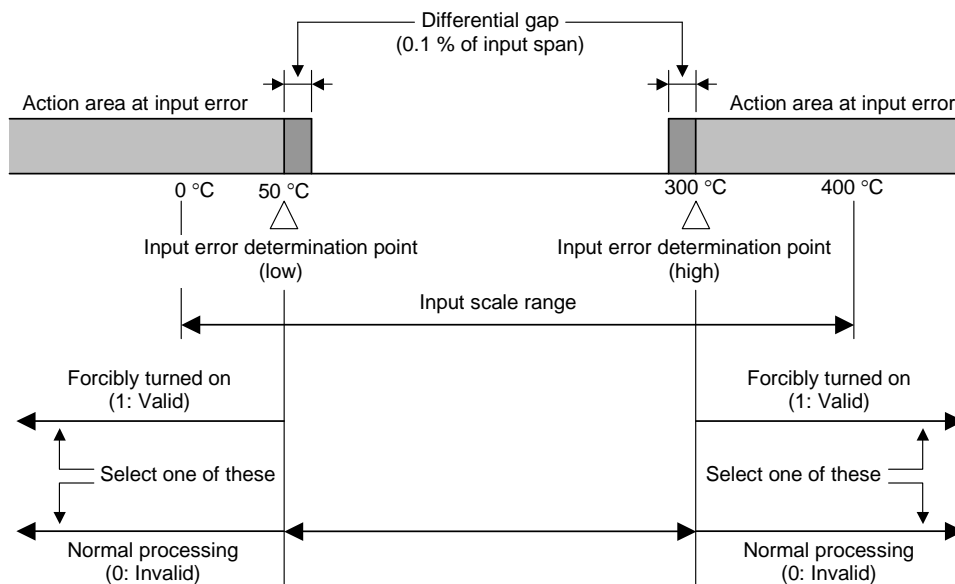

“0: Invalid”: The event output is produced depending on the selected event action status.  
 “1: Valid”: The event output is forcibly turned on regardless of the event action status.

## Function block 42 (F42.)

F42.

This is the first parameter symbol of Function block 42 (F42.).

**F42.**

### Event 2 type

E52

Use to select a action type of the Event 2.

Data range	Factory set value
0: None	0
Deviation action: 1: Deviation high <sup>1</sup> 3: Deviation high/low <sup>1</sup> 2: Deviation low <sup>1</sup> 4: Band <sup>1</sup>	If the event type is specified by the model and suffix code when ordering, that event type becomes the factory set value.
Input value action: 5: Process high <sup>1</sup> 6: Process low <sup>1</sup>	
Set value action: 7: Set value (SV) high                  8: Set value (SV) low	
Manipulated output value action: 10: Manipulated output value (MV1) high [heat-side] <sup>1,2</sup> 11: Manipulated output value (MV1) low [heat-side] <sup>1,2</sup> 12: Manipulated output value (MV2) high [cool-side] <sup>1</sup> 13: Manipulated output value (MV2) low [cool-side] <sup>1</sup>	
9: Unused	
Do not set to "9: Unused" for Event 2.	

<sup>1</sup> Event hold action is available.

<sup>2</sup> The Manipulated output value (MV) corresponds to the Feedback resistance (FBR) input value when Feedback resistance (FBR) input is used.

#### Related parameters

Parameter setting mode:

- Event 2 set value (P. 7-24)

Engineering mode

- Output assignment (P. 7-82)
- Energized/De-energized (P. 7-83)
- Alarm (ALM) lamp lighting condition 1 (P. 7-84)
- Output status at STOP mode (P. 7-85)
- Event 2 hold action (P. 7-98)
- Event 2 interlock (P. 7-99)
- Event 2 differential gap (P. 7-99)
- Event 2 delay timer (P. 7-100)
- Force ON of Event 2 action (P. 7-100)

#### ■ Description of function

For function description, refer to **Event 1 type (P. 7-88)**.

F42.

**Event 2 hold action**

EHo2

Use to set an Event hold action for the Event 2.

Data range	Factory set value
0: OFF 1: Hold action ON (Only Hold action) <ul style="list-style-type: none"> <li>• Validate the Hold action when the power is turned on.</li> <li>• Validate the Hold action when transferred from STOP (control STOP) to RUN (control RUN).</li> </ul> 2: Re-hold action ON (Hold and Re-hold actions) <ul style="list-style-type: none"> <li>• Validate the Hold action when the power is turned on.</li> <li>• Validate the Hold action when transferred from STOP (control STOP) to RUN (control RUN).</li> <li>• Validate the Re-hold action when the Set value (SV) is changed.</li> </ul> However, if the rate of setting change limiter is set to any function other than "OFF (Unused)" or in the Remote mode, the Re-hold action becomes invalid.	0  If the event type is specified by the model and suffix code when ordering, the factory set value of Event 2 hold action differs depending on that event type.



**When high alarm with Hold/Re-hold action is used for Event function, alarm does not turn on while Hold action is in operation. Use in combination with a high alarm without Hold action in order to prevent overheating which may occur by failure of control devices, such as welding of relays.**

**Related parameters**

Parameter setting mode:

- Event 2 set value (P. 7-24)

Engineering mode

- Energized/De-energized (P. 7-83)
- Alarm (ALM) lamp lighting condition 1 (P. 7-84)
- Output status at STOP mode (P. 7-85)
- Event 2 type (P. 7-97)
- Event 2 interlock (P. 7-99)
- Event 2 differential gap (P. 7-99)
- Event 2 delay timer (P. 7-100)
- Force ON of Event 2 action (P. 7-100)

**■ Description of function**For function description, refer to **Event 1 hold action (P. 7-90)**.



F42.

## Event 2 interlock

E1L2

Use to select the Interlock function for the Event 2.

Data range		Factory set value
0: Unused	1: Used	0

### Related parameters

Parameter setting mode:

- Event 2 set value (P. 7-24)

Engineering mode

- Energized/De-energized (P. 7-83)
- Alarm (ALM) lamp lighting condition 1 (P. 7-84)
- Output status at STOP mode (P. 7-85)
- Event 2 type (P. 7-97)
- Event 2 differential gap (P. 7-99)
- Force ON of Event 2 action (P. 7-100)
- Event 2 hold action (P. 7-98)
- Event 2 delay timer (P. 7-100)

### ■ Description of function

For function description, refer to **Event 1 interlock (P. 7-92)**.

F42.

## Event 2 differential gap

EH2

Use to set a Differential gap of the Event 2.

Data range	Factory set value
When Event 2 type is deviation, input value or set value actions: 0 to Input span  Varies with the setting of the Decimal point position (P. 7-73).	2
When Event 2 type is Manipulated output value action: 0.0 to 110.0 %	If the event type is specified by the model and suffix code when ordering, the factory set value of Event 2 differential gap differs depending on that event type.

### Related parameters

Parameter setting mode:

- Event 2 set value (P. 7-24)

Engineering mode:

- Decimal point position (P. 7-73)
- Alarm (ALM) lamp lighting condition 1 (P. 7-84)
- Event 2 type (P. 7-97)
- Event 2 hold action (P. 7-98)
- Event 2 delay timer (P. 7-100)
- Energized/De-energized (P. 7-83)
- Output status at STOP mode (P. 7-85)
- Event 2 interlock (P. 7-99)
- Force ON of Event 2 action (P. 7-100)

### ■ Description of function

For function description, refer to **Event 1 differential gap (P. 7-93)**.

F42.

## Event 2 delay timer



Event 2 delay timer is to set an output delay time for event outputs.

Data range	Factory set value
0.0 to 600.0 seconds	0.0

Related parameters

Parameter setting mode:

- Event 2 set value (P. 7-24)

Engineering mode

- Energized/De-energized (P. 7-83)
- Alarm (ALM) lamp lighting condition 1 (P. 7-84)
- Event 2 type (P. 7-97)
- Event 2 hold action (P. 7-98)
- Event 2 differential gap (P. 7-99)
- Output status at STOP mode (P. 7-85)
- Event 2 interlock (P. 7-99)
- Force ON of Event 2 action (P. 7-100)

### ■ Description of function

For function description, refer to **Event 1 delay timer (P. 7-94)**.

F42.

## Force ON of Event 2 action

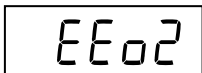

Select the operation state that is output (force ON) as the event action.

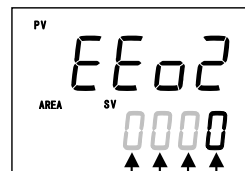

Factory set value: 0000

- Event output turned on at input error occurrence  
0: Invalid      1: Valid
- Event output turned on in manual mode  
0: Invalid      1: Valid
- Event output turned on during the autotuning (AT) function is being executed  
0: Invalid      1: Valid
- Event output turned on during the setting change rate limiter is being operated  
0: Invalid      1: Valid

Related parameters

Engineering mode:

- Input error determination point (high),  
Input error determination point (low) (P. 7-76)

### ■ Description of function

For function description, refer to **Force ON of Event 1 action (P. 7-96)**.

## Function block 43 (F43.)

F43.

This is the first parameter symbol of Function block 43 (F43.).

F43.

### Event 3 type

E53

Use to select a action type of the Event 3.

Data range	Factory set value
0: None	0
Deviation action: 1: Deviation high <sup>1</sup> 3: Deviation high/low <sup>1</sup> 2: Deviation low <sup>1</sup> 4: Band <sup>1</sup>	If the event type is specified by the model and suffix code when ordering, that event type becomes the factory set value.
Input value action: 5: Process high <sup>1</sup> 6: Process low <sup>1</sup>	
Set value action: 7: Set value (SV) high                  8: Set value (SV) low	
Manipulated output value action: 10: Manipulated output value (MV1) high [heat-side] <sup>1,2</sup> 11: Manipulated output value (MV1) low [heat-side] <sup>1,2</sup> 12: Manipulated output value (MV2) high [cool-side] <sup>1</sup> 13: Manipulated output value (MV2) low [cool-side] <sup>1</sup>	
9: Unused	
Do not set to "9: Unused" for Event 3.	

<sup>1</sup> Event hold action is available.

<sup>2</sup> The Manipulated output value (MV) corresponds to the Feedback resistance (FBR) input value when Feedback resistance (FBR) input is used.

#### Related parameters

Parameter setting mode:

- Event 3 set value (P. 7-24)

Engineering mode:

- Output assignment (P. 7-82)
- Energized/De-energized (P. 7-83)
- Alarm (ALM) lamp lighting condition 1 (P. 7-84)
- Output status at STOP mode (P. 7-85)
- Event 3 hold action (P. 7-102)
- Event 3 interlock (P. 7-103)
- Event 3 differential gap (P. 7-103)
- Event 3 delay timer (P. 7-104)
- Force ON of Event 3 action (P. 7-104)

#### ■ Description of function

For function description, refer to **Event 1 type (P. 7-88)**.

F43.

**Event 3 hold action**

EH03

Use to set an Event hold action for the Event 3.

Data range	Factory set value
0: OFF 1: Hold action ON (Only Hold action) <ul style="list-style-type: none"> <li>• Validate the Hold action when the power is turned on.</li> <li>• Validate the Hold action when transferred from STOP (control STOP) to RUN (control RUN).</li> </ul> 2: Re-hold action ON (Hold and Re-hold actions) <ul style="list-style-type: none"> <li>• Validate the Hold action when the power is turned on.</li> <li>• Validate the Hold action when transferred from STOP (control STOP) to RUN (control RUN).</li> <li>• Validate the Re-hold action when the Set value (SV) is changed.</li> </ul> However, if the rate of setting change limiter is set to any function other than “OFF (Unused)” or in the Remote mode, the Re-hold action becomes invalid.	0  If the event type is specified by the model and suffix code when ordering, the factory set value of Event 3 hold action differs depending on that event type.



**When high alarm with Hold/Re-hold action is used for Event function, alarm does not turn on while Hold action is in operation. Use in combination with a high alarm without Hold action in order to prevent overheating which may occur by failure of control devices, such as welding of relays.**

**Related parameters**

Parameter setting mode:

- Event 3 set value (P. 7-24)

Engineering mode:

- Energized/De-energized (P. 7-83)
- Alarm (ALM) lamp lighting condition 1 (P. 7-84)
- Output status at STOP mode (P. 7-85)
- Event 3 type (P. 7-101)
- Event 3 interlock (P. 7-103)
- Event 3 differential gap (P. 7-103)
- Event 3 delay timer (P. 7-104)
- Force ON of Event 3 action (P. 7-104)

**■ Description of function**For function description, refer to **Event 1 hold action (P. 7-90)**.

F43.

## Event 3 interlock

E1L3

Use to select the Interlock function for the Event 3.

Data range		Factory set value
0: Unused	1: Used	0

### Related parameters

Parameter setting mode:

- Event 3 set value (P. 7-24)

Engineering mode:

- Energized/De-energized (P. 7-83)
- Alarm (ALM) lamp lighting condition 1 (P. 7-84)
- Output status at STOP mode (P. 7-85)
- Event 3 type (P. 7-101)
- Event 3 differential gap (P. 7-103)
- Force ON of Event 3 action (P. 7-104)
- Event 3 hold action (P. 7-102)
- Event 3 delay timer (P. 7-104)

### ■ Description of function

For function description, refer to **Event 1 interlock (P. 7-92)**.

F43.

## Event 3 differential gap

EH3

Use to set a Differential gap of the Event 3.

Data range	Factory set value
When Event 3 type is deviation, input value or set value actions: 0 to Input span Varies with the setting of the Decimal point position (P. 7-73).	2
When Event 3 type is Manipulated output value action: 0.0 to 110.0 %	If the event type is specified by the model and suffix code when ordering, the factory set value of Event 3 differential gap differs depending on that event type.

### Related parameters

Parameter setting mode:

- Event 3 set value (P. 7-24)

Engineering mode:

- Decimal point position (P. 7-73)
- Alarm (ALM) lamp lighting condition 1 (P. 7-84)
- Event 3 type (P. 7-101)
- Event 3 hold action (P. 7-102)
- Event 3 delay timer (P. 7-104)
- Energized/De-energized (P. 7-83)
- Output status at STOP mode (P. 7-85)
- Event 3 interlock (P. 7-103)
- Force ON of Event 3 action (P. 7-104)

### ■ Description of function

For function description, refer to **Event 1 differential gap (P. 7-93)**.

F43.

### Event 3 delay timer



Event 3 delay timer is to set an output delay time for event outputs.

Data range	Factory set value
0.0 to 600.0 seconds	0.0

Related parameters

Parameter setting mode:

- Event 3 set value (P. 7-24)

Engineering mode:

- Energized/De-energized (P. 7-83)
- Alarm (ALM) lamp lighting condition 1 (P. 7-84)
- Event 3 type (P. 7-101)
- Event 3 hold action (P. 7-102)
- Event 3 differential gap (P. 7-103)
- Output status at STOP mode (P. 7-85)
- Event 3 interlock (P. 7-103)
- Force ON of Event 3 action (P. 7-104)

#### ■ Description of function

For function description, refer to **Event 1 delay timer (P. 7-94)**.

F43.

### Force ON of Event 3 action



Select the operation state that is output (force ON) as the event action.

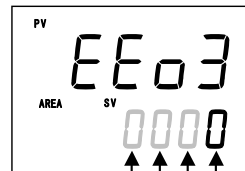

Factory set value: 0000

- Event output turned on at input error occurrence  
0: Invalid      1: Valid
- Event output turned on in manual mode  
0: Invalid      1: Valid
- Event output turned on during the autotuning (AT) function is being executed  
0: Invalid      1: Valid
- Event output turned on during the setting change rate limiter is being operated  
0: Invalid      1: Valid

Related parameters

Engineering mode

- Input error determination point (high),  
Input error determination point (low) (P. 7-76)

#### ■ Description of function

For function description, refer to **Force ON of Event 1 action (P. 7-96)**.

---

## Function block 44 (F44.)

---

F44.

This is the first parameter symbol of Function block 44 (F44.).

**F44.**

### Event 4 type

---

E54

Use to select a action type of the Event 4.

Data range	Factory set value
0: None	0
Deviation action: 1: Deviation high <sup>1</sup> 2: Deviation low <sup>1</sup> 3: Deviation high/low <sup>1</sup> 4: Band <sup>1</sup>	If the event type is specified by the model and suffix code when ordering, that event type becomes the factory set value.
Input value action: 5: Process high <sup>1</sup> 6: Process low <sup>1</sup>	
Set value action: 7: Set value (SV) high 8: Set value (SV) low	
Alarm action: 9: Control loop break alarm (LBA)	
Manipulated output value action: 10: Manipulated output value (MV1) high [heat-side] <sup>1,2</sup> 11: Manipulated output value (MV1) low [heat-side] <sup>1,2</sup> 12: Manipulated output value (MV2) high [cool-side] <sup>1</sup> 13: Manipulated output value (MV2) low [cool-side] <sup>1</sup>	

<sup>1</sup> Event hold action is available.

<sup>2</sup> The Manipulated output value (MV) corresponds to the Feedback resistance (FBR) input value when Feedback resistance (FBR) input is used.

#### Related parameters

Parameter setting mode:

- Event 4 set value (P. 7-24)
- Control loop break alarm (LBA) time (P. 7-25)
- LBA deadband (P. 7-26)

Continued on the next page.

Continued from the previous page.

Engineering mode:

- Output assignment (P. 7-82)
- Energized/De-energized (P. 7-83)
- Alarm (ALM) lamp lighting condition 1 (P. 7-84)
- Output status at STOP mode (P. 7-85)
- Event 4 hold action (P. 7-107)
- Event 4 interlock (P. 7-108)
- Event 4 differential gap (P. 7-109)
- Event 4 delay timer (P. 7-110)
- Force ON of Event 4 action (P. 7-111)

## ■ Description of function

For a description of functions other than the Control loop break alarm (LBA) function, to Event 1 type.

### Control loop break alarm (LBA)

The Control loop break alarm (LBA) function is used to detect a load (heater) break or a failure in the external actuator (magnet relay, etc.), or a failure in the control loop caused by an input (sensor) break. The LBA function is activated when control output reaches 0 % (low limit with output limit function) or 100 % (high limit with output limit function). LBA monitors variation of the Measured value (PV) for the length of LBA time. When the LBA time has elapsed and the PV is still within the alarm determination range, the LBA will be ON.

The LBA function produces the alarm when any of the following conditions occurs.

LBA determination range: TC/RTD inputs: 2 °C [°F] (fixed)  
Voltage/Current inputs: 0.2 % of input span (fixed)

#### • When the control output reaches 0 % (low limit with output limit function)

For direct action: When the LBA time has passed and the PV has not risen beyond the alarm determination range, the alarm will be turned on.

For reverse action: When the LBA time has passed and the PV has not fallen below the alarm determination range, the alarm will be turned on.

#### • When the output exceeds 100 % (low limit with output high function)

For direct action: When the LBA time has passed and the PV has not fallen below the alarm determination range, the alarm will be turned on.

For reverse action: When the LBA time has passed and the PV has not risen beyond the alarm determination range, the alarm will be turned on.



If the Autotuning function is used, the LBA time is automatically set twice as large as the Integral time. The LBA setting time will not be changed even if the Integral time is changed.



LBA function is not operative when:

- AT function is activated
- The controller is in STOP mode
- The control type is Heat/Cool PID control
- LBA function is set to "0."
- LBA function is not assigned to Event 4 (ES4).



The LBA function does not detect a location which causes alarm status. If LBA alarm is ON, check each device or wiring of the control loop.



While the LBA is ON (under alarm status), the following conditions cancel the alarm status and LBA will be OFF:

- The Measured value (PV) rises beyond (or falls below) the LBA determination range within the LBA setting time.
- The Measured value (PV) enters within the LBA deadband.



F44.

## Event 4 hold action

EH04
------

Use to set an Event hold action for the Event 4.

Data range	Factory set value
0: OFF 1: Hold action ON (Only Hold action) <ul style="list-style-type: none"> <li>• Validate the Hold action when the power is turned on.</li> <li>• Validate the Hold action when transferred from STOP (control STOP) to RUN (control RUN).</li> </ul> 2: Re-hold action ON (Hold and Re-hold actions) <ul style="list-style-type: none"> <li>• Validate the Hold action when the power is turned on.</li> <li>• Validate the Hold action when transferred from STOP (control STOP) to RUN (control RUN).</li> <li>• Validate the Re-hold action when the Set value (SV) is changed.</li> </ul> However, if the rate of setting change limiter is set to any function other than “OFF (Unused)” or in the Remote mode, the Re-hold action becomes invalid.	0  If the event type is specified by the model and suffix code when ordering, the factory set value of Event 4 hold action differs depending on that event type.



**When high alarm with Hold/Re-hold action is used for Event function, alarm does not turn on while Hold action is in operation. Use in combination with a high alarm without Hold action in order to prevent overheating which may occur by failure of control devices, such as welding of relays.**

### Related parameters

Parameter setting mode:

- Event 4 set value (P. 7-24)

Engineering mode:

- Energized/De-energized (P. 7-83)
- Alarm (ALM) lamp lighting condition 1 (P. 7-84)
- Output status at STOP mode (P. 7-85)
- Event 4 type (P. 7-105)
- Event 4 interlock (P. 7-108)
- Event 4 differential gap (P. 7-109)
- Event 4 delay timer (P. 7-110)
- Force ON of Event 4 action (P. 7-111)

### ■ Description of function

For function description, refer to **Event 1 hold action (P. 7-90)**.

F44.

## Event 4 interlock

Use to select the Interlock function for the Event 4.

Data range	Factory set value
0: Unused 1: Used	0

### Related parameters

Parameter setting mode:

- Event 4 set value (P. 7-24)
- Control loop break alarm (LBA) time (P. 7-25)
- LBA deadband (P. 7-26)

Engineering mode:

- Energized/De-energized (P. 7-83)
- Alarm (ALM) lamp lighting condition 1 (P. 7-84)
- Output status at STOP mode (P. 7-85)
- Event 4 type (P. 7-105)
- Event 4 hold action (P. 7-107)
- Event 4 differential gap (P. 7-109)
- Event 4 delay timer (P. 7-110)
- Force ON of Event 4 action (P. 7-111)

### ■ Description of function

For function description, refer to **Event 1 interlock (P. 7-92)**.

F44.

## Event 4 differential gap

EH4

Use to set a Differential gap of the Event 4.

Data range	Factory set value
When Event 4 type is deviation, input value or set value actions: 0 to Input span Varies with the setting of the Decimal point position (P. 7-73).	2
When Event 4 type is Manipulated output value action: 0.0 to 110.0 %	If the event type is specified by the model and suffix code when ordering, the factory set value of Event 4 differential gap differs depending on that event type.



For the Control loop break alarm (LBA), invalidated even if a differential gap is set.

### Related parameters

#### Parameter setting mode

- Event 4 set value (P. 7-24)

#### Engineering mode:

- Decimal point position (P. 7-73)
- Energized/De-energized (P. 7-83)
- Alarm (ALM) lamp lighting condition 1 (P. 7-84)
- Output status at STOP mode (P. 7-85)
- Event 4 type (P. 7-105)
- Event 4 hold action (P. 7-107)
- Event 4 interlock (P. 7-108)
- Event 4 delay timer (P. 7-110)
- Force ON of Event 4 action (P. 7-111)

### ■ Description of function

For function description, refer to **Event 1 differential gap (P. 7-93)**.

F44.

**Event 4 delay timer**

E4T4

Event 4 delay timer is to set an output delay time for event outputs.

Data range	Factory set value
0.0 to 600.0 seconds	0.0

**Related parameters**

Parameter setting mode:

- Event 4 set value (P. 7-24)
- Control loop break alarm (LBA) time (P. 7-25)
- LBA deadband (P. 7-26)

Engineering mode:

- Energized/De-energized (P. 7-83)
- Alarm (ALM) lamp lighting condition 1 (P. 7-84)
- Output status at STOP mode (P. 7-85)
- Event 4 type (P. 7-105)
- Event 4 hold action (P. 7-107)
- Event 4 interlock (P. 7-108)
- Event 4 differential gap (P. 7-109)
- Force ON of Event 4 action (P. 7-111)

**■ Description of function**For function description, refer to **Event 1 delay timer (P. 7-94)**.

F44.

## Force ON of Event 4 action

Select the operation state that is output (force ON) as the event action.

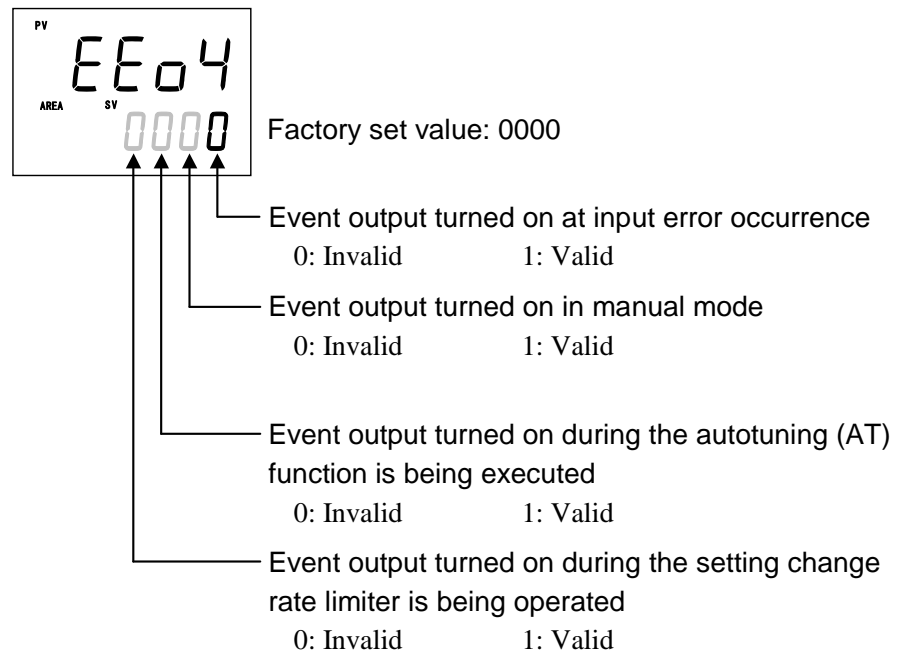

For the Control loop break alarm (LBA), invalidated even if the Force ON of Event 4 action is set.

### Related parameters

Engineering mode:

- Input error determination point (high),  
Input error determination point (low) (P. 7-76)

### ■ Description of function

For function description, refer to **Force ON of Event 1 action (P. 7-96)**.

## Function block 45 (F45.)

F45.

This is the first parameter symbol of Function block 45 (F45.).

The settings of parameters in this group become valid on the controller with the CT input (optional) function.

In addition, in order to output the Heater break alarm it is necessary to specify Output 2 (OUT2) or Digital output (optional).

### F45. CT1 ratio

CT  
input  
OPTION

CT1

Use to set the number of turns in the Current transformer which is used to monitor the current flowing through the load. There are two types of dedicated Current transformers.

The set value differs depending on the Current transformer (CT) type.

Data range	Factory set value
0 to 9999	If the Current transformer (CT) type is not specified when the order is placed: 800
Set the appropriate values below for each Current transformer type. CTL-6-P-N: 800 CTL-12-S56-10L-N: 1000	If CTL-6-P-N is specified for the Current transformer (CT) type: 800  If CTL-12-S56-10L-N is specified for the Current transformer (CT) type: 1000

#### Related parameters

Setup setting mode:

- Heater break alarm 1 (HBA1) set value (P. 7-38)
- Heater break determination point 1 (P. 7-41)
- Heater melting determination point 1 (P. 7-42)

Engineering mode:

- CT1 assignment (P. 7-113)
- Heater break alarm 1 (HBA1) type (P. 7-113)

F45.

**CT1 assignment**

CTA1

Use to assign the Current transformer (CT) input to an output from OUT1 or OUT2.

The CT input 1 is tied to HBA1, and the CT input 2 tied to HBA2, so when CT1 is assigned to OUT1, HBA1 is also automatically assigned to OUT1.

Data range	Factory set value
0: None (Heater break alarm function OFF)	1
1: OUT1	
2: OUT2	
3 to 4: Do not set this one	



To use HBA for a three-phase load, both CT inputs can be assigned to the same output.

**Related parameters****Setup setting mode:**

- Heater break alarm 1 (HBA1) set value (P. 7-38)
- Heater break determination point 1 (P. 7-41)
- Heater melting determination point 1 (P. 7-42)

**Engineering mode:**

- Output assignment (P. 7-82)
- CT1 ratio (P. 7-112)
- Heater break alarm 1 (HBA1) type (P. 7-113)

F45.

**Heater break alarm 1 (HBA1) type**

Hb51

Use to select the Heater break alarm 1 (HBA1) type.

Data range	Factory set value
0: Heater break alarm 1 (HBA1) type A The type A corresponds to the time-proportional control output.	Varies with the type of control output (OUT1) being specified at ordering. Relay, Voltage pulse, Triac, or Open-collector output: 0
1: Heater break alarm 1 (HBA1) type B The type B corresponds to the continuous control output.	Voltage/Current continuous output: 1

**Related parameters****Setup setting mode:**

- Heater break alarm 1 (HBA1) set value (P. 7-38)
- Heater break determination point 1 (P. 7-41)
- Heater melting determination point 1 (P. 7-42)

Engineering mode:

- Output assignment (P. 7-82)
- CT1 ratio (P. 7-112)
- CT1 assignment (P. 7-113)
- Number of heater break alarm 1 (HBA1) delay times (P. 7-115)

## ■ Description of function

### Heater break alarm (HBA) type A:

Heater break alarm (HBA) type A can be used with time-proportional control output (Relay, Voltage pulse, Triac or Open-collector output).

The HBA function monitors the current flowing through the load by a dedicated current transformer (CT), compares the measured value with the HBA set values, and detects a fault in the heating circuit.

### Heater break alarm (HBA) type B:

Heater break alarm (HBA) type B can be used with continuous control output (Voltage/Current continuous output).

The HBA function assumes that the heater current value is proportional\* to the control output value of the controller, otherwise viewed as the Manipulated variable (MV), and compare it with the CT input value to detect a fault in the heating or cooling circuit. However, in the case of time-proportional control output, an alarm status is only detected when the output device is melting.

\* It is assumed that the current value flowing through the load is at maximum when the control output from the controller is 100 %, and the minimum current value flowing through the load is zero (0) when the control output from the controller is 0 %.



When changing the value of CT assignment, the type of Heater break alarm (HBA) automatically changes.

CT assignment	HBA Type
1: OUT1	Type A (for time-proportional control output) or Type B (for continuous control output)
2: OUT2	Type B (for continuous control output)
0: None	Type A

Example: OUT1: Relay contact output, OUT2: Voltage/Current continuous output

When changing the value of CT assignment from OUT1 to OUT2, the type of Heater break alarm (HBA) automatically changes from Type A to B.



F45.

## Number of heater break alarm 1 (HBA1) delay times

 CT  
input  
OPTION

To prevent producing a false alarm, the alarm function waits to produce an alarm status until the measured CT input value is in an alarm range for the preset number of consecutive sampling cycles (Sampling cycle of CT input × 5).

Data range	Factory set value
0 to 255	5

### Related parameters

Setup setting mode:

- Heater break alarm 1 (HBA1) set value (P. 7-38)
- Heater break determination point 1 (P. 7-41)
- Heater melting determination point 1 (P. 7-42)

Engineering mode:

- Output assignment (P. 7-82)
- CT1 ratio (P. 7-112)
- CT1 assignment (P. 7-113)
- Heater break alarm 1 (HBA1) type (P. 7-113)

### ■ Description of function

Heater break alarm (HBA) delay time = Number of delay times × Sampling time \*

\* Twice of the measured input sampling cycle

Example:

Sampling time: 200 ms (Twice of the measured input sampling cycle [100ms])

Number of delay times: 5 times (factory set value)

HBA delay time = 5 times × 200 ms = 1000 ms = 1.0 seconds

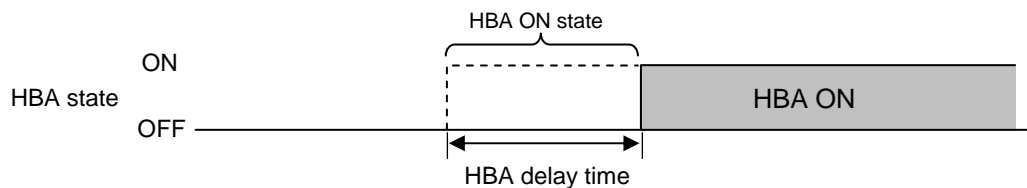

## Function block 46 (F46.)

F46.

This is the first parameter symbol of Function block 46 (F46.).

The settings of parameters in this group become valid on the controller with the CT input (optional) function.

In addition, in order to output the Heater break alarm it is necessary to specify Output 2 (OUT2) or Digital output (optional).

F46.

### CT2 ratio

CT  
input  
OPTION

CT2

Use to set the number of turns in the Current transformer which is used to monitor the current flowing through the load. There are two types of dedicated Current transformers.

The set value differs depending on the Current transformer (CT) type.

Data range	Factory set value
0 to 9999	If the Current transformer (CT) type is not specified when the order is placed: 800
Set the appropriate values below for each Current transformer type.	
CTL-6-P-N: 800	If CTL-6-P-N is specified for the Current transformer (CT) type: 800
CTL-12-S56-10L-N: 1000	If CTL-12-S56-10L-N is specified for the Current transformer (CT) type: 1000

#### Related parameters

Setup setting mode:

- Heater break alarm 2 (HBA2) set value (P. 7-38)
- Heater break determination point 2 (P. 7-41)
- Heater melting determination point 2 (P. 7-42)

Engineering mode:

- CT2 assignment (P. 7-117)
- Heater break alarm 2 (HBA2) type (P. 7-118)

F46.

**CT2 assignment**

Use to assign the Current transformer (CT) input to an output from OUT1 or OUT2.

The CT input 1 is tied to HBA1, and the CT input 2 tied to HBA2, so when CT2 is assigned to OUT2, HBA2 is also automatically assigned to OUT2.

Data range	Factory set value
0: None (Heater break alarm function OFF)	0
1: OUT1	
2: OUT2	
3 to 4: Do not set this one	



To use HBA for a three-phase load, both CT inputs can be assigned to the same output.

**Related parameters**

Setup setting mode:

- Heater break alarm 2 (HBA2) set value (P. 7-38)
- Heater break determination point 2 (P. 7-41)
- Heater melting determination point 2 (P. 7-42)

Engineering mode:

- Output assignment (P. 7-82)
- CT2 ratio (P. 7-116)
- Heater break alarm 2 (HBA2) type (P. 7-118)

F46.

**Heater break alarm 2 (HBA2) type**CT  
input  
OPTION

Hb52

Use to select the Heater break alarm 2 (HBA2) type.

Data range	Factory set value
0: Heater break alarm 2 (HBA2) type A The type A corresponds to the time- proportional control output.	0
1: Heater break alarm 2 (HBA2) type B The type B corresponds to the continuous control output.	

**Related parameters**

Setup setting mode:

- Heater break alarm 2 (HBA2) set value (P. 7-38)
- Heater break determination point 2 (P. 7-41)
- Heater melting determination point 2 (P. 7-42)

Engineering mode:

- Output assignment (P. 7-82)
- CT2 ratio (P. 7-116)
- CT2 assignment (P. 7-117)
- Number of heater break alarm 2 (HBA2) delay times (P. 7-118)

**■ Description of function**For function description, refer to **Heater break alarm 1 (HBA1) type (P. 7-113)**.

F46.

**Number of heater break alarm 2 (HBA2) delay times**CT  
input  
OPTION

HbC2

To prevent producing a false alarm, the alarm function waits to produce an alarm status until the measured CT input value is in an alarm range for the preset number of consecutive sampling cycles (Sampling cycle of CT input × 5).

Data range	Factory set value
0 to 255	5

**Related parameters**

Setup setting mode:

- Heater break alarm 2 (HBA2) set value (P. 7-38)
- Heater break determination point 2 (P. 7-41)
- Heater melting determination point 2 (P. 7-42)

Engineering mode:

- Output assignment (P. 7-82)
- CT2 assignment (P. 7-117)
- CT2 ratio (P. 7-116)
- Heater break alarm 2 (HBA2) type (P. 7-118)

**■ Description of function**For function description, refer to **Number of heater break alarm 1 (HBA1) delay times (P. 7-115)**.

## Function block 50 (F50.)



This is the first parameter symbol of Function block 50 (F50.).

F50.

### Hot/Cold start



Use to select the start mode at power recovery.

Data range	Factory set value
0: Hot start 1    2: Cold start 1: Hot start 2    3: STOP start	0

#### Related parameters

Operation mode:

- Auto/Manual transfer (P. 7-18)

Engineering mode:

- Start determination point (P. 7-120)
- Manipulated output value (MV1) at STOP mode,  
Manipulated output value (MV2) at STOP mode (P. 7-132)
- Output limiter low (MV1), Output limiter low (MV2) (P. 7-135)
- Valve action at STOP (P. 7-156)

### ■ Description of function

The operation of this instrument is not affected by a power failure of 20 ms or less. The control start mode at power recovery after more than 20 ms power failure can be selected as follows.

Action when power failure recovers	Operation mode when power failure recovers	Output value when power failure recovers	
Hot start 1	Same as that before power failure	Near the output value before power failure occurs.	
Hot start 2	Same as that before power failure	Auto mode	Value as a result of control computation <sup>2</sup>
		Manual mode	Output limiter low <sup>3</sup>
Cold start	Manual	Output limiter low <sup>3</sup>	
STOP start	Started in the control stop (STOP) state regardless of the RUN mode before power failure. <sup>1</sup>	Manipulated output value at STOP mode <sup>3</sup>	

Factory set value: Hot start 1

<sup>1</sup> If changed to RUN from STOP by RUN/STOP transfer after start, set to the operation mode before power failure occurs.

<sup>2</sup> The result of control computation varies with the control response parameter.

<sup>3</sup> If there is no Feedback resistance (FBR) input in Position proportioning PID control, the following results.

- Hot start 2 (Manual mode): No output (no control motor is driven)
- Cold start: No output (no control motor is driven)
- STOP start: In accordance with the setting of valve action at STOP

Continued on the next page.

Continued from the previous page.



If the Startup tuning (ST) function is executed or an automatic temperature rise is made just when the power is turned on or selection is made from STOP to RUN as one of the startup conditions, control starts at Hot start 2 even if set to Hot start 1 (factory set value).

F50.

## Start determination point

PdA

Determination point always set to Hot start 1 when recovered from power failure.

Data range	Factory set value
0 to Input span (The unit is the same as input value.) (0: Operation starts from any start state selected by Hot/Cold start.) Varies with the setting of the Decimal point position (P. 7-73).	3 % of input span

### Related parameter

Engineering mode:

- Decimal point position (P. 7-73)
- Hot/Cold start (P. 7-119)

### ■ Description of function

- The start state is determined according to the Measured value (PV) level [deviation from set value] at power recovery.
- When a Measured value (PV) is between the determination points on the + (plus) and – (minus) sides, always started from Hot start 1 when recovered.
- When a Measured value (PV) is out of the determination points or the Start determination point is set at “0,” operation starts from any start state selected by Hot/Cold start.

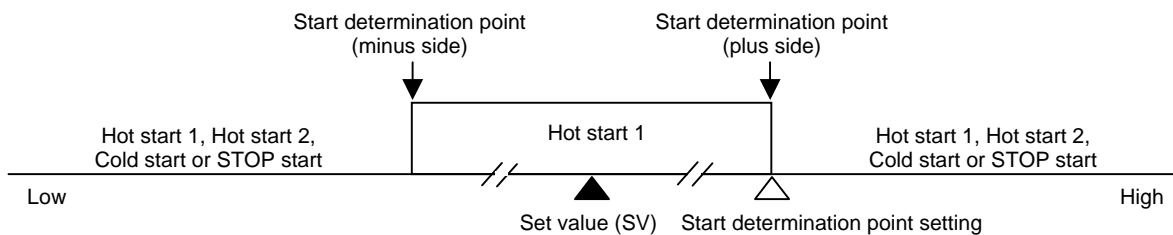

F50.

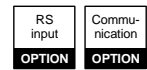
**External input type**

CA $\bar{n}$
--------------

Use to select the type of external input.

Data range	Factory set value
0: Remote setting (RS) input 1: Intercontroller communication cascade control 2: Intercontroller communication ratio setting	0

 Intercontroller communication cascade control or Intercontroller communication ratio setting can be performed when the port of Communication 2 is ready to be used and also the Communication 2 protocol (CMP2) is set to “2: Intercontroller communication.”

 When cascade control or ratio setting is performed, the master controller is set to “0: Remote setting (RS) input.”  
Set each slave controller to “1: Intercontroller communication cascade control” or “2: Intercontroller communication ratio setting.”

 For the Remote setting (RS) input, refer to **6.8 Remote/Local Transfer (P. 6-29)**.

 For the cascade control, refer to **6.14.5 Cascade control function (P. 6-81)**.

 For the ratio setting, refer to **6.14.6 Ratio setting function (P. 6-89)**.

**Related parameters**

Operation mode:

- Remote/Local transfer (P. 7-19)

Engineering mode:

- Master channel selection (P. 7-122)
- Communication 1 protocol, Communication 2 protocol (P. 7-162)

F50.



## Master channel selection

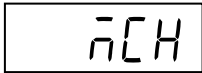

Set the master controller address set by Device address2 (Add2) to Master channel selection (MCH) of each slave controller.

This setting is necessary for the slave controller to identify the master controller when Intercontroller cascade control or Intercontroller ratio setting is performed.

Data range	Factory set value
0 to 31	0

This setting is valid when the master channel selection is set to “1: Intercontroller communication cascade control” or “2: Intercontroller communication ratio setting.”

### Related parameters

Setup setting mode:

- Device address 2 (P. 7-47)

Engineering mode:

- External input type (P. 7-121)

Application: When used in the following condition

Intercontroller communication: Cascade control or ratio setting

Address 0: Master controller

Address 1 and Address 2: Slave controllers

Cascade control or Ratio setting via Intercontroller communication

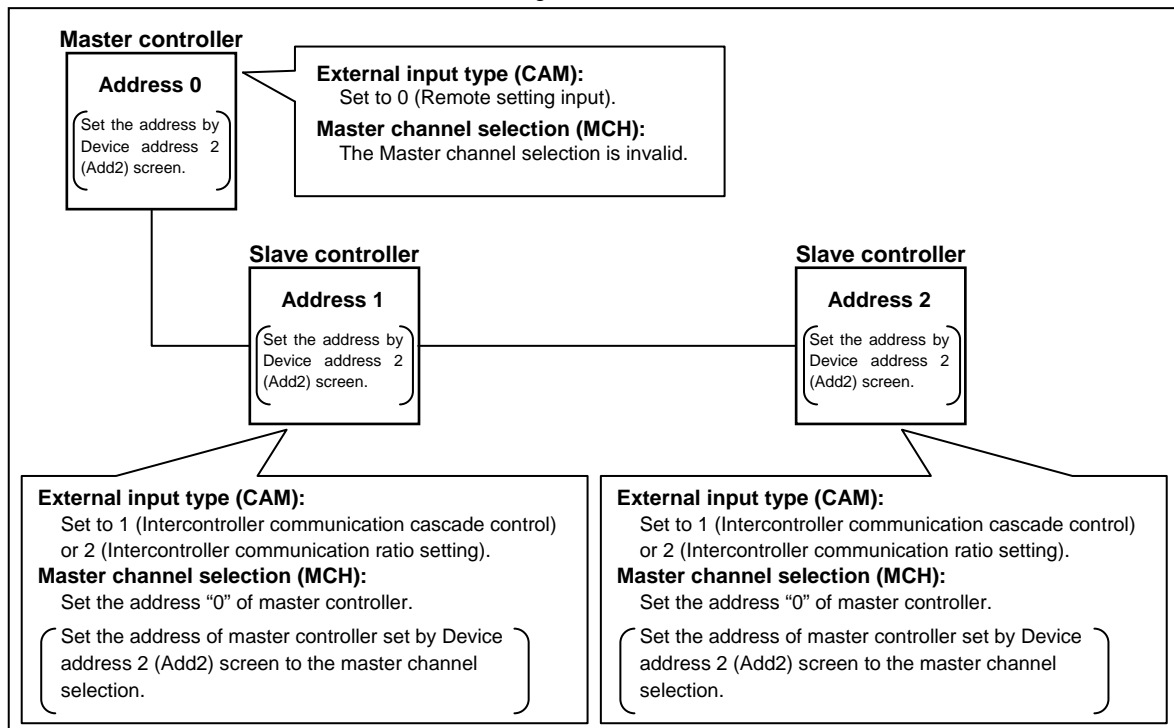



F50.

## SV tracking

RS  
input  
OPTION

r r t

To select Use/Unuse of SV tracking.

Data range	Factory set value
0: Unused 1: Used	1

Related parameter

Operation mode:

- Remote/Local transfer (P. 7-19)

### ■ Description of function

With SV tracking function, when Remote/Local mode is transferred from Remote to Local, the set value used in Remote mode before the mode transfer will be kept using in Local mode to prevent rapid set value change.

Operation mode:	Local	→	Remote	→	Local
Set value used	Local set value		Remote set value		Local set value
SV tracking used	Local set value ≠ Remote set value		Local set value ≠ Remote set value		Local set value = Remote set value
SV tracking unused	Local set value ≠ Remote set value		Local set value ≠ Remote set value		Local set value ≠ Remote set value

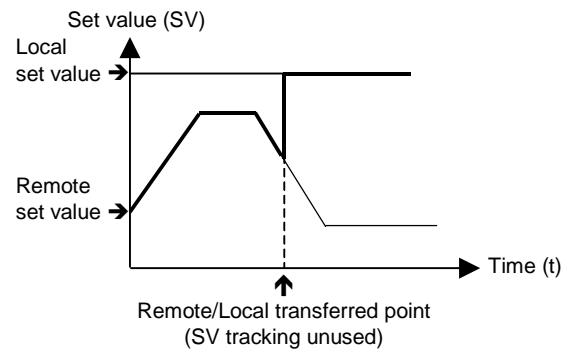
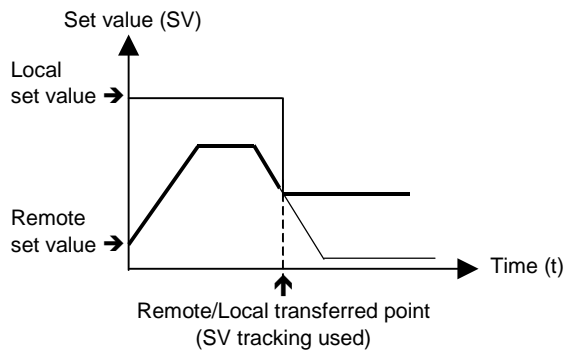

F50.

**MV transfer function**

The Manipulated output value used for manual control is selected when the Operation mode is changed to the Manual mode from the Auto mode.

Data range	Factory set value
0: Manipulated output value (MV1 or MV2) in Auto mode is used. [Balanceless/Bumpless function]	0 (Balanceless/Bumpless function)
1: When selected by Digital input (DI): Manipulated output value (MV1 or MV2) in previous Manual mode is used. [MV transfer function] When selected by front key: Manipulated output value (MV1 or MV2) in Auto mode is used. [Balanceless/Bumpless function]	
2: Manipulated output value (MV1 or MV2) in previous Manual mode is used. [MV transfer function]	

**Related parameters**

SV setting & monitor mode:

- Manipulated output value at MV transfer (P. 7-11)

Operation mode:

- Auto/Manual transfer (P. 7-18)

For the Balanceless/bumpless function, refer to **6.7 Auto/Manual Transfer (P. 6-23)**.

F50.

**PV transfer function**

It is selected whether or not Measured value (PV) with the operation mode transferred to Auto mode from Manual mode is used as Set value (SV).

It is possible to prevent a Manipulated output value (MV) from its sudden change by substituting Measured value (PV) for Set value (SV).

Data range	Factory set value
0: Unused 1: Used	0

**Related parameter**

Operation mode:

- Auto/Manual transfer (P. 7-18)

## Function block 51 (F51.)

F51.

This is the first parameter symbol of Function block 51 (F51.).

### F51. Control action

05

Use to select the action type of control.

Data range	Factory set value
0: Brilliant II PID control (direct action)	1
1: Brilliant II PID control (reverse action)	
2: Brilliant II Heat/Cool PID control [water cooling]	
3: Brilliant II Heat/Cool PID control [air cooling]	
4: Brilliant II Heat/Cool PID control [Cooling gain linear type]	
5: Brilliant II Position proportioning PID control (reverse action)	
6: Brilliant II Position proportioning PID control (direct action)	

If the control action is specified by the model and suffix code when ordering, that control action becomes the factory set value.



With Output 2 (OUT2) optional, Heat/Cool PID control and Position proportioning PID control can be set.

#### ■ Description of function

##### ● PID control (direct action)

The Manipulated output value (MV) increases as the Measured value (PV) increases. This action is used generally for cool control.

##### ● PID control (reverse action)

The Manipulated output value (MV) decreases as the Measured value (PV) increases. This action is used generally for heat control.

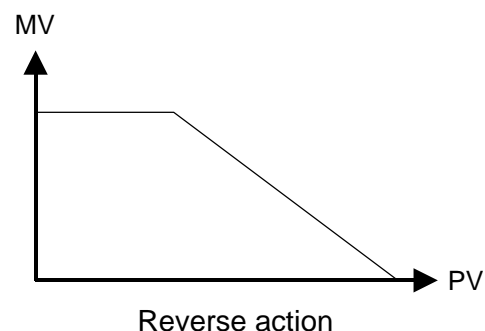
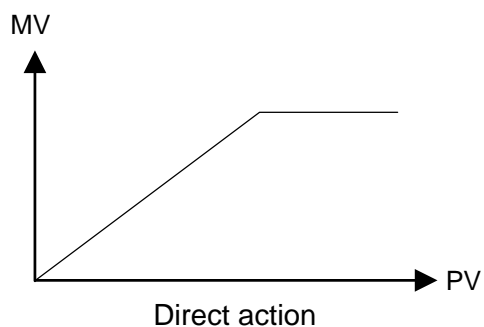

● **Heat/Cool PID control**

In Heat/Cool control, only one controller enables heat and cool control. For example, this is effective when cool control is required in extruder cylinder temperature control.

**Water cooling/Air cooling:** The algorithm assuming plastic molding machine Heat/Cool control is employed. Even in equipment provided with a cooling mechanism having nonlinear characteristics, it responds quickly to attain the characteristic responding to the set value with small overshooting.

**Cooling gain linear type:** The algorithm assuming applications without nonlinear cooling capability is employed.

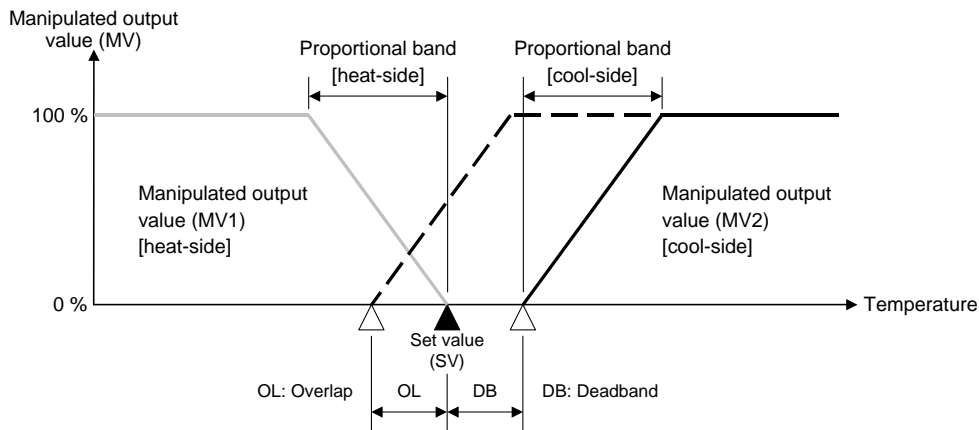

● **Position proportioning PID control**

Position proportioning PID control converts the control output value of the controller into the corresponding signal to control a motor driven valve (control motor) and then performs temperature control of a controlled object by regulating fluid flow. In Position proportioning PID control of this controller, it is possible to select the presence or absence of Feedback resistance (FBR) input which monitors the degree of valve opening (necessary to be selected when ordering). In addition, the direct action or reverse action can be selected.

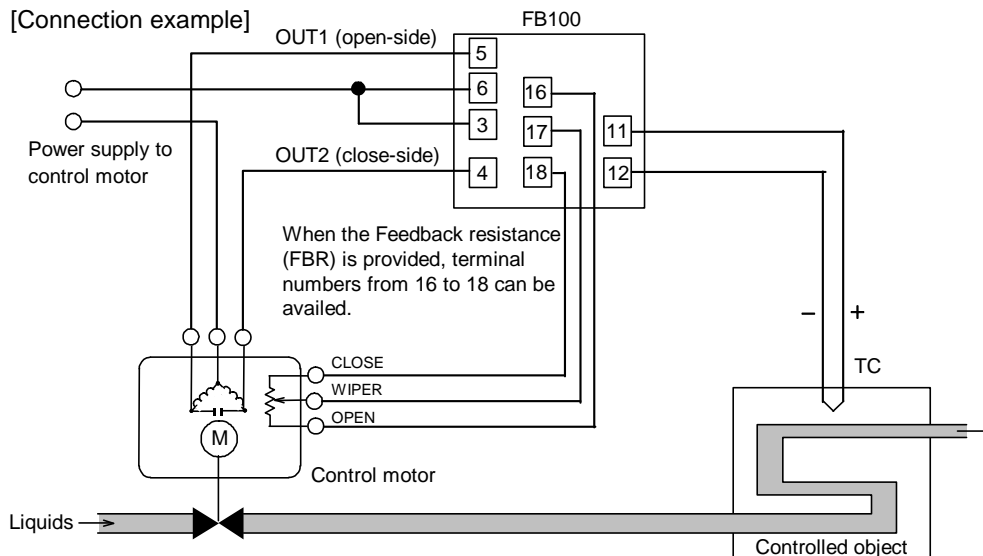

The details of setting differ depending on the presence or absence of Feedback resistance (FBR) input.

When the Feedback resistance (FBR) is provided:

- High/Low limit of valve position (limit value of FBR input) can be set. [Output limiter high, Output limiter low]
- The valve position can be manually changed. [Manipulated output value (MV) setting in Manual mode]
- The feedback adjustment is necessary. [Feedback adjustment preparation]
- Action taken when Feedback resistance (FBR) input breaks can be selected. [Action at Feedback resistance (FBR) input error]
- Output value (FBR input) with the output turned on or off when the Autotuning (AT) function is executed can be restricted. [Output value with AT turned on, Output value with AT turned off]
- The close-side (or open-side) output remains ON when the valve position is fully closed (or opened). [Action at saturated output]

When the Feedback resistance (FBR) is not provided:

- Control motor operation can be restricted by the Integrated output limiter. [Integrated output limiter]
- The UP/DOWN key is used to output opening or closing signal in Manual mode.

UP key (open-side): While the UP key is being pressed, open-side output (OUT1) is output continuously. Releasing the UP key turns off the output on the open-side to hold the opened state at that time.

DOWN key (close-side): While the DOWN key is being pressed, close-side output (OUT2) is output continuously. Releasing the DOWN key turns off the output on the closed-side to hold the opened state at that time.

Parameter Valid/Invalid depending on the presence or absence of FBR input (×: Valid, -: Invalid)

Parameter (Engineering mode)	When the Feedback resistance (FBR) input is provided	When the Feedback resistance (FBR) input is not provided
Manipulated output value (MV1) at STOP mode	×	—
Output limiter high [MV1] Output limiter low [MV1]	×	—
Output value with AT turned on Output value with AT turned on	×	—
Open/Close output neutral zone *	×	×
Open/Close output differential gap *	×	×
Action at Feedback resistance (FBR) input error	×	—
Feedback adjustment	×	—
Control motor time *	×	×
Integrated output limiter	—	×
Valve action at STOP*	×	×
Action at saturated output	×	—

\* Always set this item regardless of the presence or absence of opening Feedback resistance (FBR) input.



Position proportioning PID control can be performed if two output points are selected when ordering.



When the control action is the Position proportioning PID control, the Startup tuning (ST) is not available. In addition, the Output change rate limiter is invalid.



For the setting method of Position proportioning PID control, refer to **6.12 Position Proportioning PID Control (P. 6-43)**.

### Brilliant II PID control

PID control is a control method of achieving stabilized control result by setting P (Proportional band), I (Integral time) and D (Derivative time) constants, and is widely used. However with this PID control if P, I and D values are set to focus on “better response to control set value change,” “response to external disturbance” deteriorates. In contrast, if PID values are set to focus on “better response to external disturbance,” “response to control set value change” deteriorates. In brilliant II PID control a form of “response to control set value change” can be selected from among **Fast**, **Medium** and **Slow** with PID constants remaining unchanged so as to be in good “response to external disturbance.” In addition, the controller is provided with the function which restricts the amount of undershooting caused by the cooling nonlinear characteristic possessed by plastic molding machines when the Set value (SV) is lowered in Heat/Cool PID control.

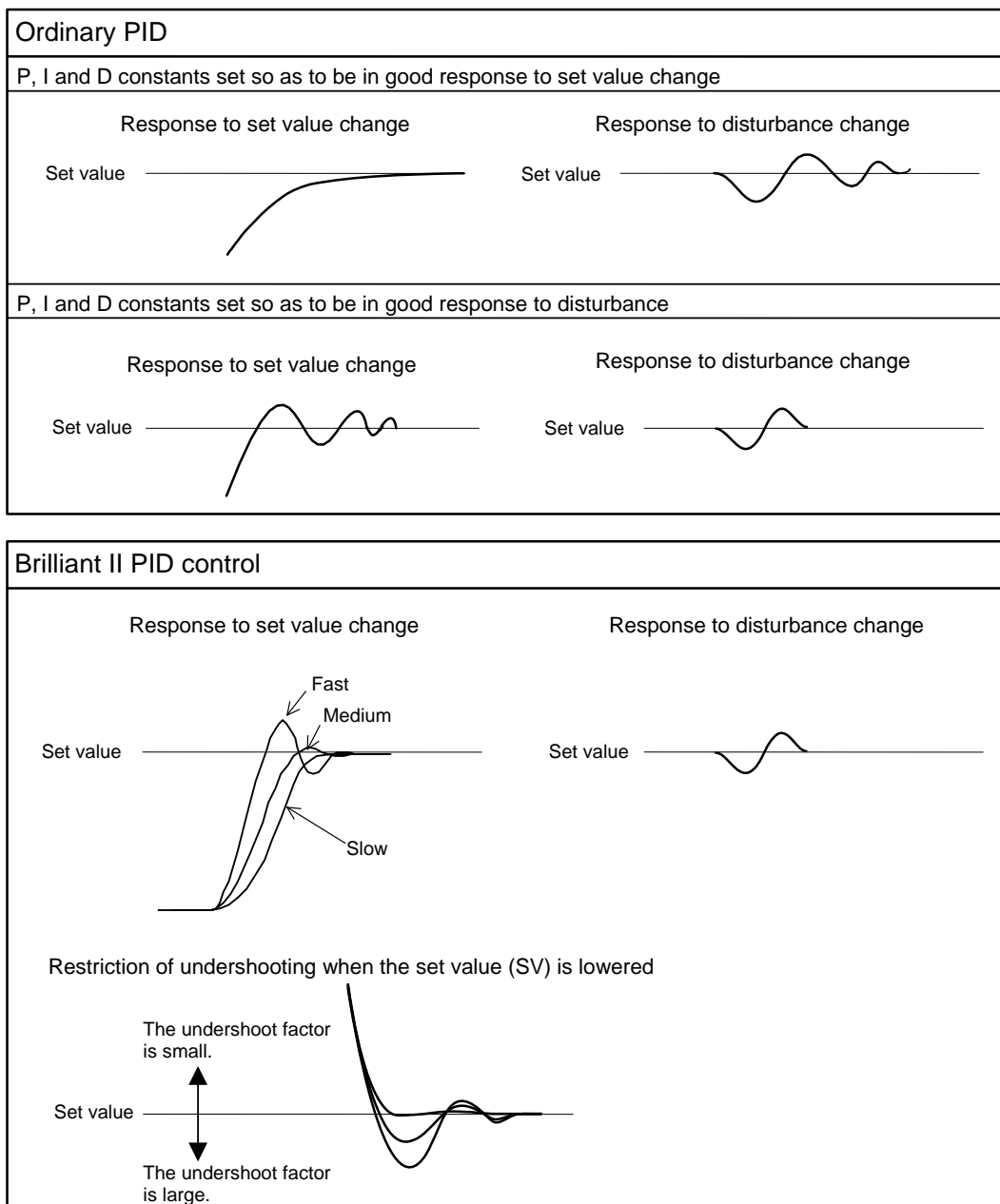

F51.

## Integral/Derivative time decimal point position

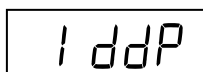

Use to select a Decimal point position of Integral time and Derivative time.

Data range	Factory set value
0: 1 second setting (No decimal place) 1: 0.1 seconds setting (One decimal place)	0

### Related parameters

(Item whose position of the decimal point is automatically converted if the position of the decimal point is changed.)

Parameter setting mode:

- Integral time [heat-side] (P. 7-28)
- Integral time [cool-side] (P. 7-30)
- Derivative time [heat-side] (P. 7-28)
- Derivative time [cool-side] (P. 7-31)

Engineering mode:

- Integral time limiter (high) [heat-side] (P. 7-145)
- Integral time limiter (low) [heat-side] (P. 7-145)
- Derivative time limiter (high) [heat-side] (P. 7-146)
- Derivative time limiter (low) [heat-side] (P. 7-146)
- Integral time limiter (high) [cool-side] (P. 7-148)
- Integral time limiter (low) [cool-side] (P. 7-148)
- Derivative time limiter (high) [cool-side] (P. 7-149)
- Derivative time limiter (low) [cool-side] (P. 7-149)

F51.

## Derivative gain

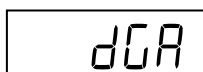

Use to set a gain used for the derivative action in PID control. Derivative gain should not be changed under ordinary operation.

Data range	Factory set value
0.1 to 10.0	6.0



Under ordinary operation, it is not necessary to change the factory set value.

### Related parameters

Parameter setting mode:

- Derivative time [heat-side] (P. 7-28)
- Derivative time [cool-side] (P. 7-31)

Engineering mode:

- Derivative time limiter (high) [heat-side] (P. 7-146)
- Derivative time limiter (low) [heat-side] (P. 7-146)
- Derivative time limiter (high) [cool-side] (P. 7-149)
- Derivative time limiter (low) [cool-side] (P. 7-149)

F51.

**ON/OFF action differential gap (upper)**  
**ON/OFF action differential gap (lower)**

oHH

ON/OFF action differential gap (upper):

Use to set the ON/OFF control differential gap (upper).

oHL

ON/OFF action differential gap (lower):

Use to set the ON/OFF control differential gap (lower).

Data range	Factory set value
TC/RTD inputs: 0 to Input span (Unit: °C [°F]) Varies with the setting of the Decimal point position (P. 7-73).	1
Voltage (V)/Current (I) inputs: 0.0 to 100.0 % or input span	0.1 % of input span

**Related parameter**

Parameter setting mode:

- Proportional band [heat-side] (P. 7-27)

Engineering mode:

- Decimal point position (P. 7-73)

**■ Description of function**

ON/OFF control is possible when the Proportional band is set to “0” or “0.0.” In ON/OFF control with Reverse action, when the Measured value (PV) is smaller than the Set value (SV), the Manipulated output (MV) is 100 % or ON. When the PV is higher than the SV, the MV is 0 % or OFF.

Differential gap setting prevents control output from repeating ON and OFF too frequently.

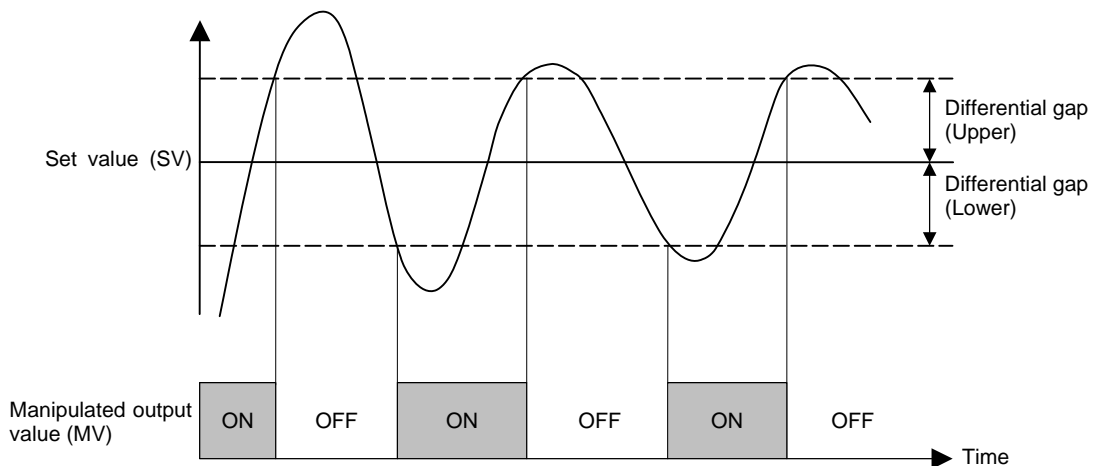



F51.

**Action (high) at input error****Action (low) at input error**

A0HE

A1NE

Action (high) at input error:

Use to select the action when the measured value reaches the Input error determination point (high).

Action (low) at input error:

Use to select the action when the measured value reaches the Input error determination point (low).

Data range	Factory set value
0: Normal control	0
1: Manipulated output value at input error	

Related parameters

Engineering mode:

- Input error determination point (high),  
Input error determination point (low) (P. 7-76)
- Manipulated output value at input error (P. 7-132)

**■ Description of function**

Input Error Determination:

Example: Input range: 0 to 400 °C  
 Input error determination point (high): 300 °C  
 Input error determination point (low): 50 °C

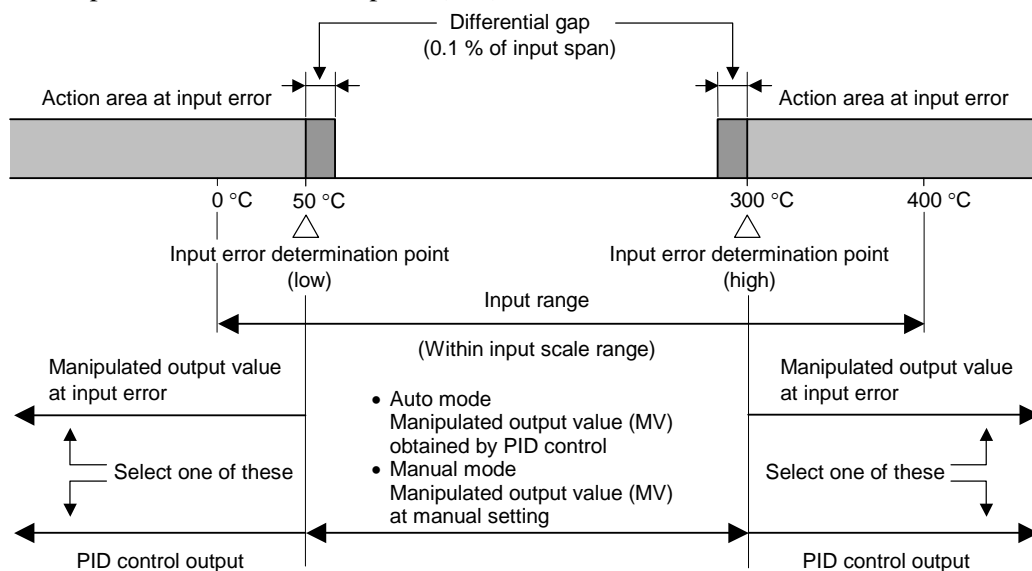

[Manipulated output action at input error]

## • Auto mode

Selected to the Manual mode just when determined to be at input error to output the manipulated output value set by the Manipulated output value at input error.

## • Manual mode

Not selected to the Manipulated output value at input error even if determined to be at input error.



When selected to RUN (control start) with any input error (burnout, etc.) occurring at STOP (control stop), not selected to the Manipulated output value at input error (both in Auto and Manual modes).



F51.

**Manipulated output value at input error**

P5n

When the measured value reaches Input error determination point and Action at input error is set to “1: Manipulated output value at input error,” this manipulated value is output.

Data range	Factory set value
-105.0 to +105.0 %	0.0

-  The actual output value becomes the value restricted by the Output limiter.
-  When the control action is the Position proportioning PID control:  
When there is no Feedback resistance (FBR) input or the same input breaks, action taken at that time is in accordance with the Valve action setting at STOP.

**Related parameters**

Engineering mode:

- Action (high) at input error, Action (low) at input error (P. 7-131)
- Output limiter high (MV1), Output limiter low (MV1) (P. 7-135)
- Valve action at STOP (P. 7-156)

F51.

**Manipulated output value (MV1) at STOP mode****Manipulated output value (MV2) at STOP mode**

rāy1

rāy2

Manipulated output value to be output at STOP (control stop)

Data range	Factory set value
-5.0 to +105.0 %	-5.0

-  When the control action is the Position proportioning PID control:  
Only when there is Feedback resistance (FBR) input and it does not break, the Manipulated output value (MV1) at STOP (mode) is output.

**Related parameter**

Operation mode:

- RUN/STOP transfer (P. 7-21)

F51.

**Output change rate limiter (up) [MV1]****Output change rate limiter (down) [MV1]****Output change rate limiter (up) [MV2]****Output change rate limiter (down) [MV2]**

oru

ord

oru2

ord2

Use to set the Output change rate limiter (upward side) to limit of the variation of output is set. Use to set the Output change rate limiter (down).

Data range	Factory set value
0.0 to 100.0 %/second of manipulated output (0.0: OFF)	0.0



Invalid when the control action is the Position proportioning PID control.

Related parameters

Engineering mode:

- Output limiter high (MV1), Output limiter low (MV1),  
Output limiter high (MV2), Output limiter low (MV2) (P. 7-135)

### ■ Description of function

The Output change rate limiter limits the variation of Manipulated output (MV) per second. This function is suitable for an application in which a sudden MV change is not acceptable.

Example: The Output change rate limiter is effective.

- The MV reaches 100 % when the power is turned on to the controller and such a sudden output change is not acceptable in the application.
- A sudden output change occurs at the SV change and it is not acceptable in the application.

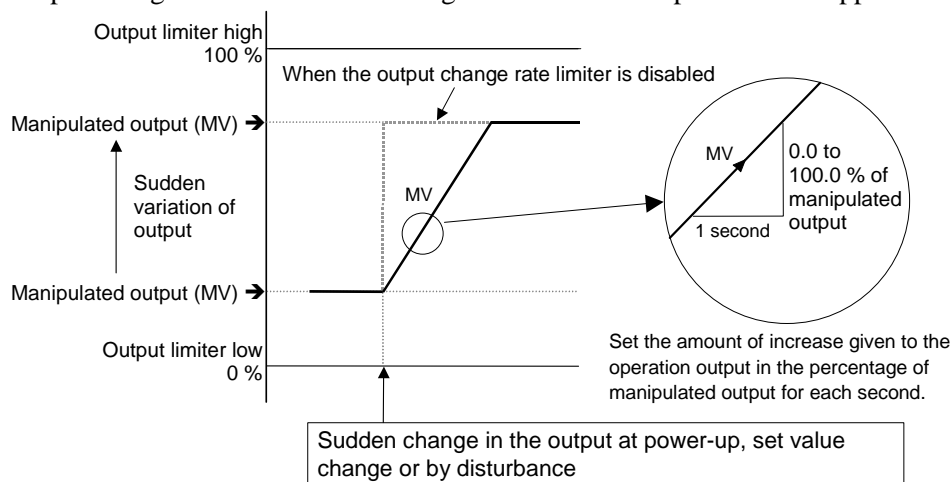

The output changes at specific rates set by Output change rate limiter (up) even under the situations where a sudden output change would occur without Output change rate limiter function. There is also independent Output change rate limiter (down).

Continued on the next page.

Continued from the previous page.



If the output change rate is set smaller, it will cause slow control response and affect derivative action.



When the Output change rate limiter is used, you may not be able to obtain appropriate PID constants by Autotuning.



The Output change rate limiter is particularly effective when a sudden MV change may create uncontrollable situation cause a large current flow. Also, it is very effective current output or voltage output is used as control output.

F51.

## Output limiter high (MV1)    Output limiter high (MV2)

## Output limiter low (MV1)    Output limiter low (MV2)

oLH

Output limiter high (MV1):

Use to set the high limit value of Manipulated output (MV1) [heat-side].

oLL

Output limiter low (MV1):

Use to set the low limit value of Manipulated output (MV1) [heat-side].

oLH2

Output limiter high (MV2):

Use to set the high limit value of Manipulated output (MV2) [cool-side].

oLL2

Output limiter low (MV2):

Use to set the low limit value of Manipulated output (MV2) [cool-side].

Data range	Factory set value
Output limiter high (MV1): Output limiter low (MV1) to 105.0 %	105.0
Output limiter high (MV2): Output limiter low (MV2) to 105.0 %	105.0
Output limiter low (MV1): -5.0 % to Output limiter high (MV1)	-5.0
Output limiter low (MV2): -5.0 % to Output limiter high (MV2)	-5.0



When the control action is the Position proportioning PID control:  
Only when there is opening Feedback resistance (FBR) input and it does not break, the output limiter becomes valid.

### Related parameters

SV setting &amp; monitor mode:

- Manipulated output value at MV transfer (P. 7-11)

Engineering mode:

- Manipulated output value at input error (P. 7-132)
- Output change rate limiter (up) [MV1], Output change rate limiter (down) [MV1],  
Output change rate limiter (up) [MV2],  
Output change rate limiter (down) [MV2] (P. 7-133)
- Output value with AT turned on, Output value with AT turned off (P. 7-143)

### ■ Description of function

This is the function which restricts the high and low limits of Manipulated output values (MV).

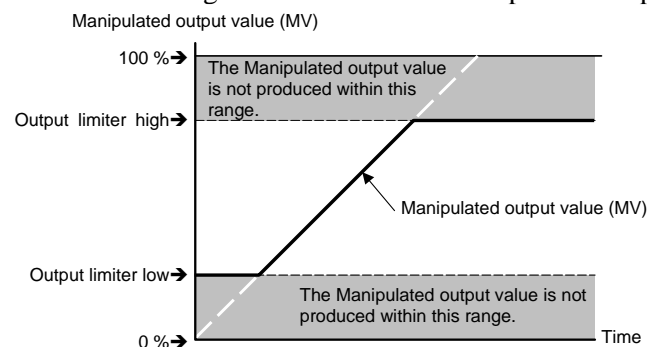

Output limiter is available for ON/OFF action.

F51.

**Derivative action**

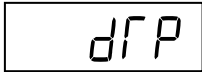

Use to select the action of derivative term.

Data range	Factory set value
0: Measured value derivative	0
1: Deviation derivative	

In Position proportioning PID control, action becomes Measured value derivative regardless of the setting.

Related parameter

Operation mode:

- PID/AT transfer (P. 7-15)

■ **Description of function**

Measured value derivative: PID control putting much emphasis on response most adaptive to fixed set point control (mode)

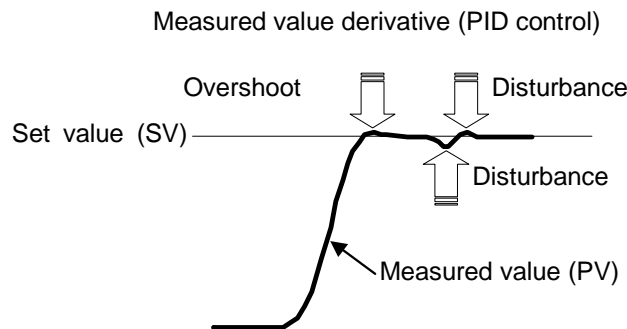

Deviation derivative:

PID control putting much emphasis on follow-up most adaptive to ramp control or cascade control using a ratio of setting change limiter, etc. It is effective to follow-up at powering up a load or restrict the amount of overshooting when changed to Soak from Ramp.

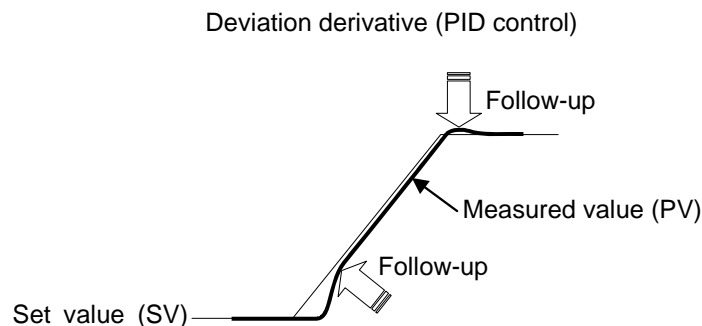

F51.

## Undershoot suppression factor

US

This is a factor to suppress undershoot on the cool side.

Data range	Factory set value
0.000 to 1.000	Water cooling: 0.100 Air cooling: 0.250 Cooling gain linear type: 1.000



The Undershoot suppression factor is invalid even if set when control is not in Heat/Cool PID control.

Related parameter

Engineering mode:

- Control action (P. 7-125)

### ■ Description of function

The Undershoot suppression function suppresses the undershoot that occurs when the Set value (SV) is lowered due to the special cooling characteristic (cooling nonlinear characteristic) of plastic molding machines. The undershoot suppression effect increases as a smaller value is set for the Undershoot suppression factor.

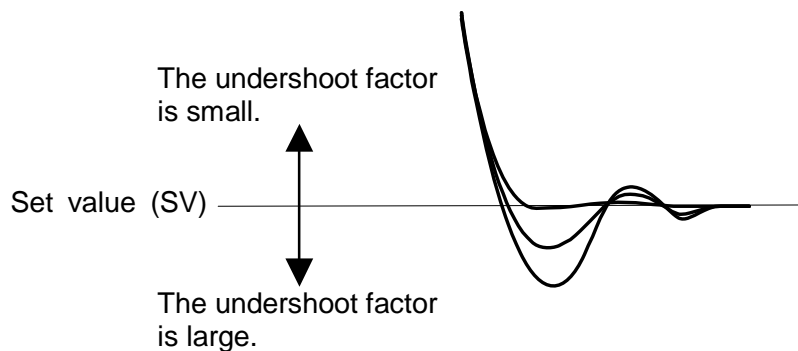

**If the Undershoot suppression factor is set too small, the undershoot function acts excessively and prevents the Measured value (PV) from reaching the Set value (SV). As a result, the PV stabilizes at an offset or approaches the set value very slowly, preventing normal control.**

**In this event, change the setting for the Undershoot suppression factor to a slightly higher value.**

F51.

## Overlap/Deadband reference point

dbPA

Adjust the Overlap/Deadband reference point at Heat/Cool PID control.

Data range	Factory set value
0.0 to 1.0	0.0



Overlap/Deadband reference point can only be adjusted when the control method is Heat/Cool PID control.

### Related parameter

Parameter setting mode:

- Proportional band [heat-side] (P. 7-27)
- Proportional band [cool-side] (P. 7-30)
- Overlap/Deadband (P. 7-32)

Engineering mode:

- Control action (P. 7-125)

### ■ Description of function

Each Set value (SV) for the Heat/Cool PID control becomes the Overlap/Deadband reference point.

- When setting 0.0, Overlap/Deadband reference point is at 0 % of the output at Proportional band [heat-side].
- When setting 0.5, Overlap/Deadband reference point is at the midpoint of the Overlap/Deadband.
- When setting 1.0, Overlap/Deadband reference point is at 0 % of the output at Proportional band [cool-side].

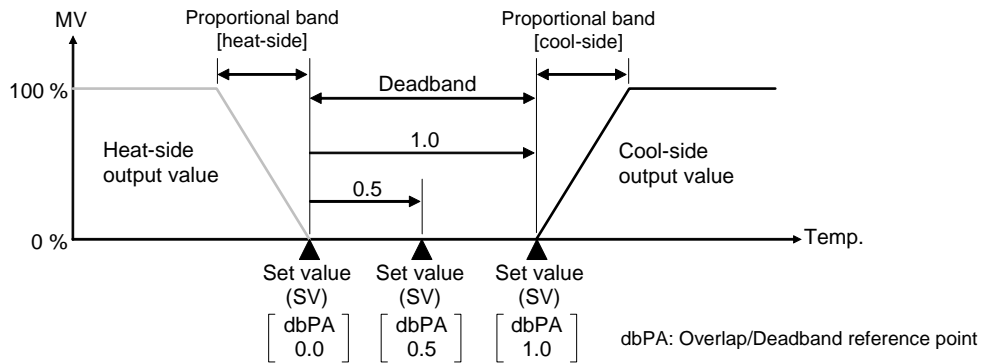

### Example: Difference in Overlap/Deadband reference point

[Overlap/Deadband reference point: 0.0 ]

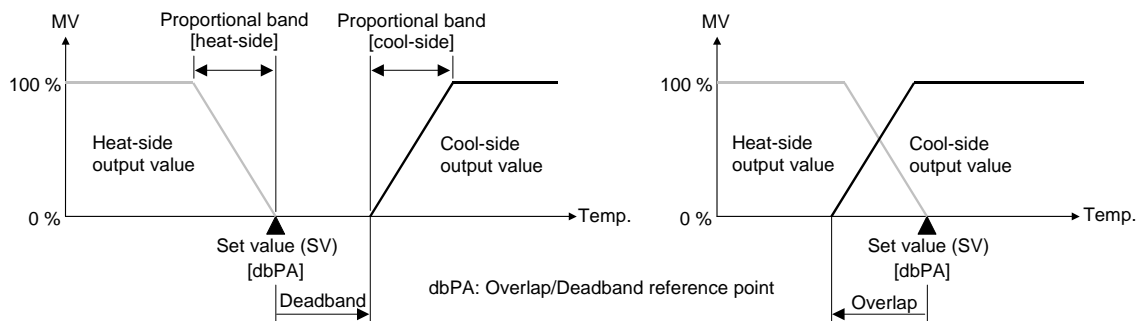



[Overlap/Deadband reference point: 0.5]

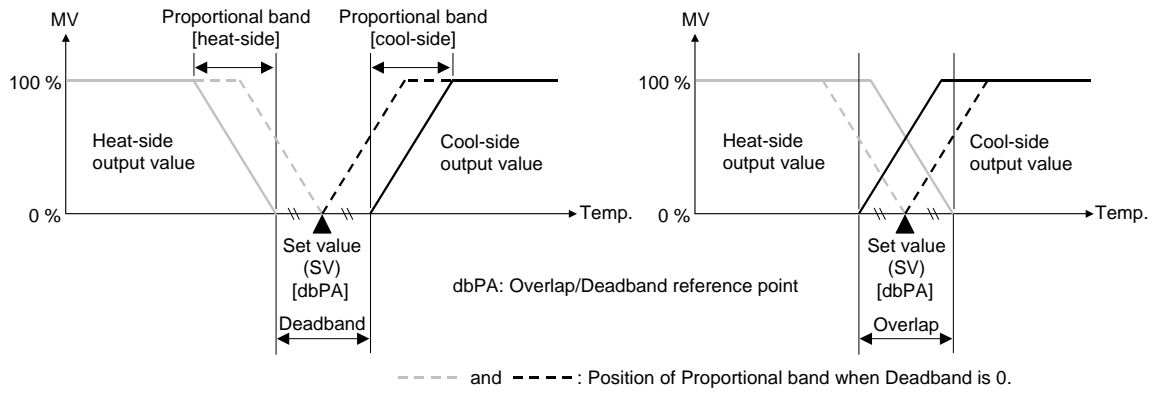

[Overlap/Deadband reference point: 1.0]

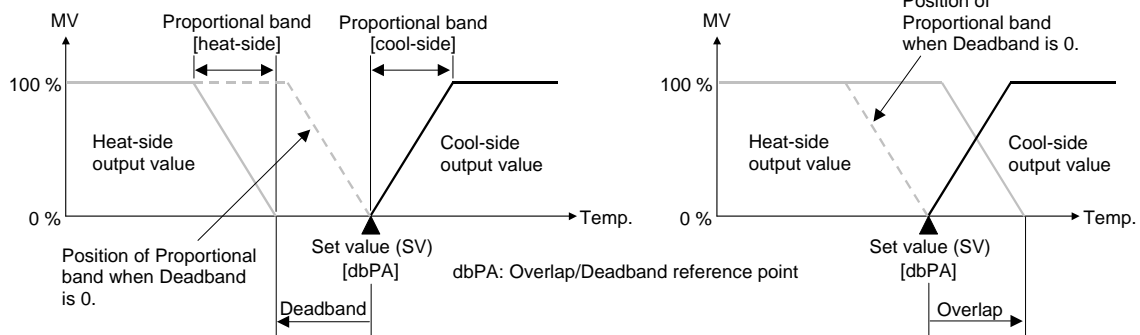

To change Deadband when the Overlap/Deadband reference point is 0.5, the Proportional band on heat-side and cool-side shift equidistantly to the midpoint of the Overlap/Deadband.

## Function block 52 (F52.)

F52.

This is the first parameter symbol of Function block 52 (F52.).

F52.

### AT bias

ATb

Use to set a bias to move the set value only when Autotuning (AT) is activated.

Data range	Factory set value
–Input span to +Input span Varies with the setting of the Decimal point position (P. 7-73).	0

Related parameter

Operation mode:

- PID/AT transfer (P. 7-15)

Engineering mode:

- Decimal point position (P. 7-73)

### ■ Description of function

The AT bias is used to prevent overshoot during Autotuning in the application which does not allow overshoot even during Autotuning. RKC Autotuning method uses ON/OFF control at the set value to compute the PID values. However, if overshoot is a concern during Autotuning, the desired AT bias should be set to lower the set point during Autotuning so that overshoot is prevented.

[Example] When AT bias is set to the minus (–) side.

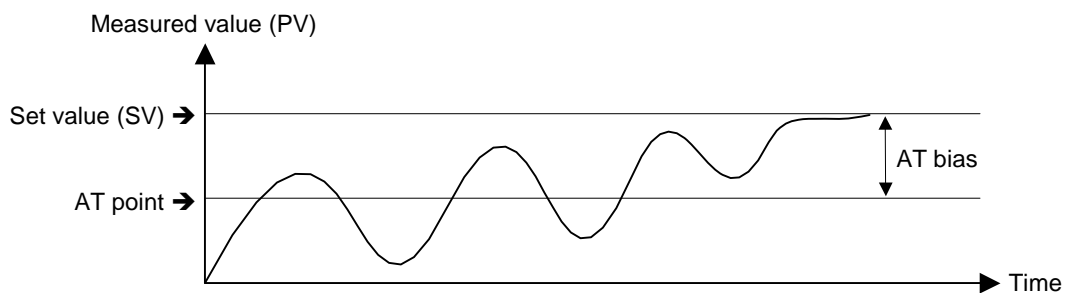



F52.

**AT differential gap time**

AFH
-----

Use to set an ON/OFF action differential gap time for Autotuning (AT). This function prevents the AT function from malfunctioning caused by noise.

Data range	Factory set value
0.0 to 50.0 seconds	10.0

Related parameter

Operation mode:

- PID/AT transfer (P. 7-15)

**■ Description of function**

In order to prevent the output from chattering due to the fluctuation of a Measured value (PV) caused by noise during Autotuning, the output on or off state is held until AT differential gap time has passed after the output on/off state is changed to the other.

Set AT differential gap time to “ $1/100 \times$  Time required for temperature rise.”

[Example]

A: AT cycle time when the AT differential gap time is set to 0.0 second

The output chatters due to the fluctuation of the Measured value (PV) caused by noise, and Autotuning (AT) function is not able to monitor appropriate cycles to compute suitable PID values.

B: AT cycle time when the AT differential gap time is set to “Time corresponding to 0.25 cycles.”

The fluctuation of a Measured value (PV) caused by noise is ignored and as a result Autotuning (AT) function is able to monitor appropriate cycles to compute suitable PID values.

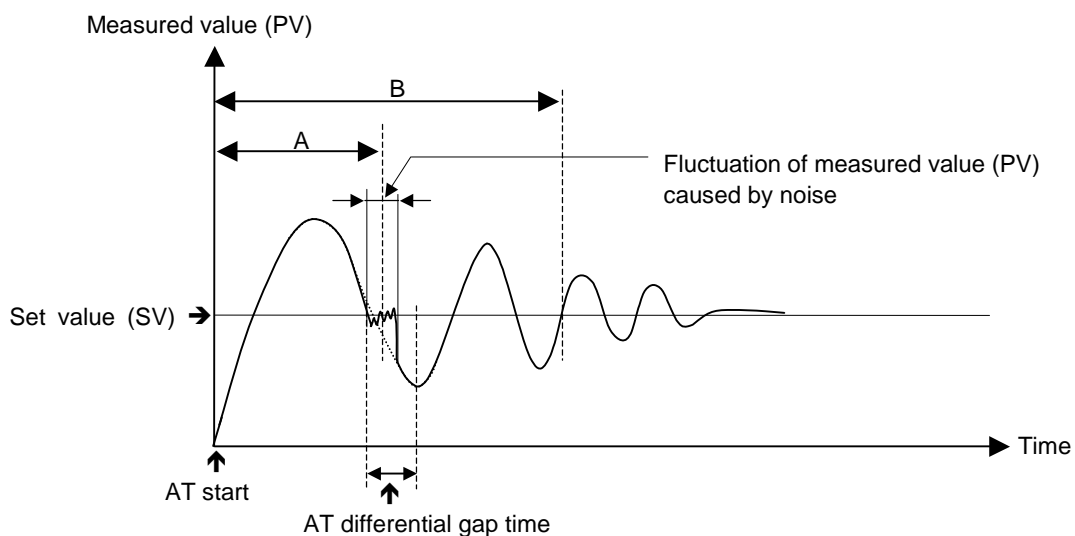

The factory set value of the AT cycle is 2 cycles.

F52.

## Output value with AT turned on

## Output value with AT turned off

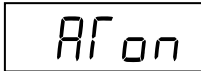

Output value with AT turned on:

This parameter is for limiting the Manipulated output value (ON side) while the Autotuning (AT) function is being executed.

Output value with AT turned off:

This parameter is for limiting the Manipulated output value (OFF side) while the Autotuning (AT) function is being executed.

Data range	Factory set value
Output value with AT turned on: Output value with AT turned off to +105.0 %	105.0
Output value with AT turned off: -105.0 % to Output value with AT turned on	-105.0



The actual output value becomes the value restricted by the output limiter.



When the control action is the Position proportioning PID control:  
Only when there is Feedback resistance (FBR) input and it does not break, the output value with AT turned on or output value with AT turned off becomes valid.

Output value with AT turned on:

High limit value for Feedback resistance input while the Autotuning (AT) function is being executed

Output value with AT turned off:

Low limit value for Feedback resistance input while the Autotuning (AT) function is being executed

### Related parameters

Operation mode:

- PID/AT transfer (P. 7-15)

Engineering mode:

- Output limiter high (MV1), Output limiter low (MV1),  
Output limiter high (MV2), Output limiter low (MV2) (P. 7-135)

### ■ Plus (+)/Minus (-) setting when in Heat/Cool PID control

Set the output value with AT turned on to a plus (+) value.	Output value with the heat-side turned on = Output value with AT turned on Output value with the heat-side turned off = Output limiter low (MV1) [heat-side]
Set the output value with AT turned off to a minus (-) value.	Output value with the cool-side turned on = Output value with AT turned off Output value with the cool-side turned off = Output limiter low (MV2) [cool-side]
Set the output values with AT turned on and off to plus (+) values.	The Autotuning (AT) function is executed only on the heat-side. Output value with the heat-side turned on = Output value with AT turned on Output value with the heat-side turned off = Output value with AT turned off (Output value with AT turned on > Output value with AT turned off)
Set the output values with AT turned on and off to minus (-) values.	The Autotuning (AT) function is executed only on the cool-side. Output value with the cool-side turned on = Output value with AT turned off Output value with the cool-side turned off = Output value with AT turned on (Output value with AT turned on > Output value with AT turned off)

**F52.****Proportional band limiter (high) [heat-side]****Proportional band limiter (low) [heat-side]**

PLH

PLL

Proportional band limiter (high) [heat-side]:

Use to set the high limit value of Proportional band [heat-side].

Proportional band limiter (low) [heat-side]:

Use to set the low limit value of Proportional band [heat-side].

The Proportional band [heat-side] range is restricted while the Startup tuning (ST) and Autotuning (AT) functions are being executed.

Data range	Factory set value
TC/RTD inputs: 0 (0.0, 0.00) to Input span (Unit: °C [°F]) Varies with the setting of the Decimal point position (P. 7-73).	Proportional band limiter (high): Input span Proportional band limiter (low): 0 (0.0, 0.00)
Voltage (V)/Current (I) inputs: 0.0 to 1000.0 % of input span	Proportional band limiter (high): 1000.0 % Proportional band limiter (low): 0.0 %

**Related parameters**

Operation mode:

- PID/AT transfer (P. 7-15)
- Startup tuning (ST) (P. 7-16)

Parameter setting mode:

- Proportional band [heat-side] (P. 7-27)

Engineering mode:

- Decimal point position (P. 7-73)

F52.

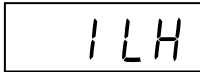
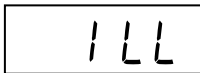
**Integral time limiter (high) [heat-side]****Integral time limiter (low) [heat-side]**



Integral time limiter (high) [heat-side]:

Use to set the high limit value of Integral time [heat-side].

Integral time limiter (low) [heat-side]:

Use to set the low limit value of Integral time [heat-side].

The Integral time [heat-side] range is restricted while the Startup tuning (ST) and Autotuning (AT) functions are being executed.

Data range	Factory set value
0 to 3600 seconds or 0.0 to 1999.9 seconds	Integral time limiter (high): 3600 Integral time limiter (low): 0

 The Decimal point position for data differs depending on the Integral/Derivative time decimal point position.

 If the Autotuning (AT) function is executed when the Integral time limiter (high) [heat-side] is set at “0” or “0.0,” P and D values suitable to PD control (heat-side) are computed (excluding the Position proportioning PID control).

**Related parameters**

Operation mode:

- PID/AT transfer (P. 7-15)
- Startup tuning (ST) (P. 7-16)

Parameter setting mode:

- Integral time [heat-side] (P. 7-28)

Engineering mode:

- Integral/Derivative time decimal point position (P. 7-129)

F52.

**Derivative time limiter (high) [heat-side]****Derivative time limiter (low) [heat-side]**

DLH

Derivative time limiter (high) [heat-side]:

Use to set the high limit value of Derivative time [heat-side].

DLL

Derivative time limiter (low) [heat-side]:

Use to set the low limit value of Derivative time [heat-side].

The Derivative time [heat-side] range is restricted while the Startup tuning (ST) and Autotuning (AT) functions are being executed.

Data range	Factory set value
0 to 3600 seconds or 0.0 to 1999.9 seconds	Derivative time limiter (high): 3600 Derivative time limiter (low): 0

 The Decimal point position for data differs depending on the Integral/Derivative time decimal point position.

 If the Autotuning (AT) function is executed when the Derivative time limiter (high) [heat-side] is set at "0" or "0.0," P and I values suitable to PI control (heat-side) are computed.

**Related parameters**

Operation mode:

- PID/AT transfer (P. 7-15)
- Startup tuning (ST) (P. 7-16)

Parameter setting mode:

- Derivative time [heat-side] (P. 7-28)

Engineering mode:

- Integral/Derivative time decimal point position (P. 7-129)



F52.

**Proportional band limiter (high) [cool-side]****Proportional band limiter (low) [cool-side]****PcLH****PcLL**

Proportional band limiter (high) [cool-side]:

Use to set the high limit value of Proportional band [cool-side].

Proportional band limiter (low) [cool-side]:

Use to set the low limit value of Proportional band [cool-side].

The Proportional band [cool-side] range is restricted while the Autotuning (AT) function is being executed.

Data range	Factory set value
TC/RTD inputs: 1 (0.1, 0.01) to Input span (Unit: °C [°F]) Varies with the setting of the Decimal point position (P. 7-73).	Proportional band limiter (high): Input span Proportional band limiter (low): 1 (0.1, 0.01)
Voltage (V)/Current (I) inputs: 0.1 to 1000.0 % of input span	Proportional band limiter (high): 1000.0 % Proportional band limiter (low): 0.1 %



The Proportional band limiter (high) [cool-side] and Proportional band limiter (low) [cool-side] are valid only during Heat/Cool PID control.

**Related parameters**

Operation mode:

- PID/AT transfer (P. 7-15)

Parameter setting mode:

- Proportional band [cool-side] (P. 7-30)

Engineering mode:

- Decimal point position (P. 7-73)

F52.

**Integral time limiter (high) [cool-side]****Integral time limiter (low) [cool-side]**

I cLH

I cLL

Integral time limiter (high) [cool-side]:

Use to set the high limit value of Integral time [cool-side].

Integral time limiter (low) [cool-side]:

Use to set the low limit value of Integral time [cool-side].

The Integral time [cool-side] range is restricted while the Autotuning (AT) function is being executed.

Data range	Factory set value
0 to 3600 seconds or 0.0 to 1999.9 seconds	Integral time limiter (high): 3600 Integral time limiter (low): 0

 The Decimal point position for data differs depending on the Integral/Derivative time decimal point position.

 If the Autotuning (AT) function is executed when the Integral time limiter (high) [cool-side] is set at “0” or “0.0,” P and D values suitable to PD control (cool-side) are computed.

 The Integral time limiter (high) [cool-side] and Integral time limiter (low) [cool-side] are valid only during Heat/Cool PID control.

**Related parameters**

Operation mode:

- PID/AT transfer (P. 7-15)

Parameter setting mode:

- Integral time [cool-side] (P. 7-30)

Engineering mode:

- Integral/Derivative time decimal point position (P. 7-129)

F52.

**Derivative time limiter (high) [cool-side]****Derivative time limiter (low) [cool-side]**

dclH

Derivative time limiter (high) [cool-side]:

Use to set the high limit value of Derivative time [cool-side].

dclL

Derivative time limiter (low) [cool-side]:

Use to set the low limit value of Derivative time [cool-side].

The Derivative time [cool-side] range is restricted while the Autotuning (AT) function is being executed.

Data range	Factory set value
0 to 3600 seconds or 0.0 to 1999.9 seconds	Derivative time limiter (high): 3600 Derivative time limiter (low): 0

 The Decimal point position for data differs depending on the Integral/Derivative time decimal point position.

 If the Autotuning (AT) function is executed when the Derivative time limiter (high) [cool-side] is set at “0” or “0.0,” P and I values suitable to PI control (cool-side) are computed.

 The Derivative time limiter (high) [cool-side] and Derivative time limiter (low) [cool-side] are valid only during Heat/Cool PID control.

**Related parameters**

Operation mode:

- PID/AT transfer (P. 7-15)

Parameter setting mode:

- Derivative time [cool-side] (P. 7-31)

Engineering mode:

- Integral/Derivative time decimal point position (P. 7-129)

F52.

**Proportional band adjusting factor [heat-side]****Proportional band adjusting factor [cool-side]**

PAU

PcAU

Proportional band adjusting factor [heat-side]:

This is a factor which is multiplied by the Proportional band [heat-side] computed by executing the Autotuning (AT) function.

Proportional band adjusting factor [cool-side]:

This is a factor which is multiplied by the Proportional band [cool-side] computed by executing the Autotuning (AT) function.

Data range	Factory set value
0.01 to 10.00 times	1.00



The Proportional band adjusting factor [cool-side] is valid only during Heat/Cool PID control.

## Related parameters

Operation mode:

- PID/AT transfer (P. 7-15)

Parameter setting mode:

- Proportional band [heat-side] (P. 7-27)
- Proportional band [cool-side] (P. 7-30)

F52.

**Integral time adjusting factor [heat-side]****Integral time adjusting factor [cool-side]**

IAU

IcAU

Integral time adjusting factor [heat-side]:

This is a factor which is multiplied by the Integral time [heat-side] computed by executing the Autotuning (AT) function.

Integral time adjusting factor [cool-side]:

This is a factor which is multiplied by the Integral time [cool-side] computed by executing the Autotuning (AT) function.

Data range	Factory set value
0.01 to 10.00 times	1.00



The Integral time adjusting factor [cool-side] is valid only during Heat/Cool PID control.

## Related parameters

Operation mode:

- PID/AT transfer (P. 7-15)

Parameter setting mode:

- Integral time [heat-side] (P. 7-28)
- Integral time [cool-side] (P. 7-30)

F52.

**Derivative time adjusting factor [heat-side]****Derivative time adjusting factor [cool-side]**

dAu

dcAu

Derivative time adjusting factor [heat-side]:

This is a factor which is multiplied by the Derivative time [heat-side] computed by executing the Autotuning (AT) function.

Derivative time adjusting factor [cool-side]:

This is a factor which is multiplied by the Derivative time [cool-side] computed by executing the Autotuning (AT) function.

Data range	Factory set value
0.01 to 10.00 times	1.00

 The Derivative time adjusting factor [cool-side] is valid only during Heat/Cool PID control.

**Related parameters**

Operation mode:

- PID/AT transfer (P. 7-15)

Parameter setting mode:

- Derivative time [heat-side] (P. 7-28)
- Derivative time [cool-side] (P. 7-31)

## Function block 53 (F53.)

F53.

This is the first parameter symbol of Function block 53 (F53.).

Only when Position proportioning PID control is selected, the parameters in this block are valid.

In addition, if no Feedback resistance (FBR) input is specified when ordering, there are parameters which will become invalid even when set.

F53.

### Open/Close output neutral zone

Ydb

Use to set Open/Close output neutral zone.

Data range	Factory set value
0.1 to 10.0 % of output	2.0

Related parameters

Engineering mode:

- Open/Close output differential gap (P. 7-153)
- Action at feedback resistance (FBR) input error (P. 7-153)
- Feedback adjustment (P. 7-154)

#### ■ Description of function

The neutral zone is used to prevent a control motor from repeating ON/OFF too frequently. When the PID computed output value is within the neutral zone, the controller will not output the MV to a control motor.

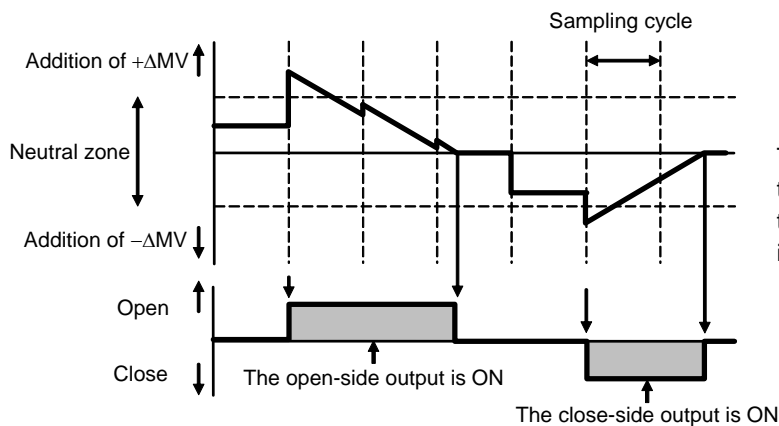

F53.

## Open/Close output differential gap

445

Use to set differential gap of Open/Close output used in the Position proportioning PID control.

Data range	Factory set value
0.1 to 5.0 % of output	1.0

Related parameters

Engineering mode:

- Open/Close output neutral zone (P. 7-152)
- Action at feedback resistance (FBR) input error (P. 7-153)
- Feedback adjustment (P. 7-154)

### ■ Description of function

The Open/Close output differential gap prevents output ON/OFF chattering caused by fluctuation of feedback resistance input.

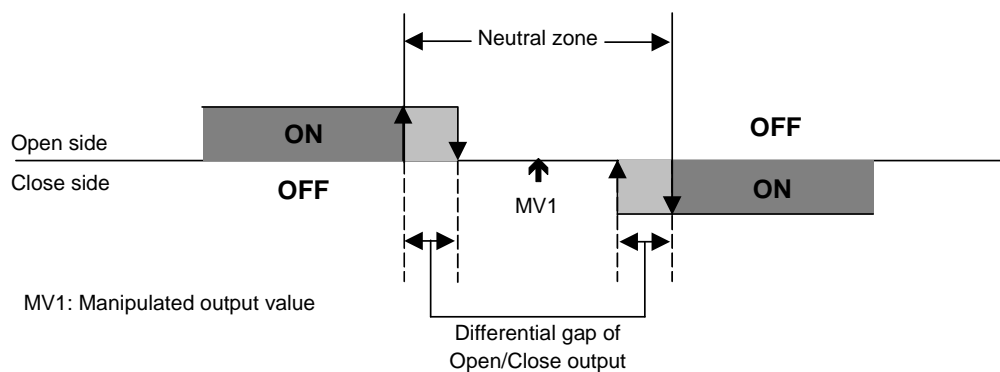

F53.

## Action at Feedback resistance (FBR) input error

FBR  
input  
OPTION

46r

Use to select an action at the Feedback resistance (FBR) input break.

Data range	Factory set value
0: Action depending on the value action at STOP 1: Control action continued	0

Related parameters

Engineering mode:

- Open/Close output neutral zone (P. 7-152)
- Open/Close output differential gap (P. 7-153)
- Feedback adjustment (P. 7-154)
- Valve action at STOP (P. 7-156)

F53.

## Feedback adjustment



Pos

Feedback adjustment function is to adjust controller's output value to match the Feedback resistance (FBR) of the control motor.

After the adjustment, the Manipulated output value of 0 to 100 % obtained after PID computation matches the valve position signal of the fully closed position to the fully opened position [Feedback resistance (FBR) input] sent from the control motor. The adjustment have to be completed before starting operation.

Always make sure that the wiring is correct and the control motor operates normally before the adjustment. (Refer to P. 7-126)

In addition, if opening adjustment is performed, the control motor time is automatically computed. However, if the time thus computed is less than 5 seconds, no set value is updated.

Data range	Factory set value
0 (AdJ): Adjustment end	—
1 (oPn): During adjustment on the open-side	—
2 (CL5): During adjustment on the close-side	—

### ■ Adjustment procedure

At the Adjustment preparation screen, press the shift key for 5 seconds to start the adjustment. The display automatically returns to the Adjustment preparation screen after the adjustment is completed.

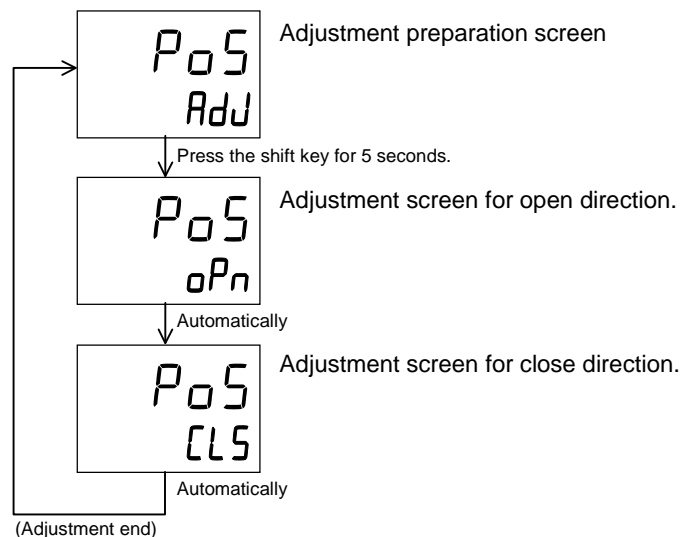

Display returns to the PV/SV monitor screen if no key operation is performed within 1 minute (except during the feedback adjustment).



F53.

**Control motor time**

This is the time required until the control motor is fully opened from its fully closed state.

Data range	Factory set value
5 to 1000 seconds	10



If opening adjustment is performed, the Control motor time is automatically computed. However, if the time thus computed is less than 5 seconds, no set value is updated.

Related parameter

Engineering mode:

- Integrated output limiter (P. 7-155)

F53.

**Integrated output limiter**

This is a restricted value when the output on the open or closed side is integrated. If the output on the open (or closed) side is output in succession, it is integrated and if the result reaches the Integrated output limiter value, the output on the open (or closed) side is turned off. In addition, if the output on the open (or closed) side is reversed, the integrated value is reset.

Data range	Factory set value
0.0 to 200.0 % of control motor time (0.0: Integrated output limiter function OFF)	150.0



The Integrated output limiter is invalid when the Feedback resistance (FBR) input was used.

Related parameter

Engineering mode:

- Control motor time (P. 7-155)

### ■ Setting example

If control is started at the fully closed state when the control motor time is set at 10 seconds and the Integrated output limiter value is set at 100 %, the following results.

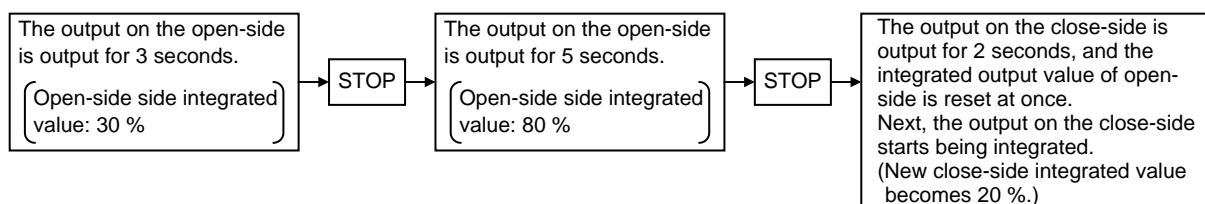

F53.

**Valve action at STOP**

Select the valve action when Feedback resistance (FBR) input is disabled or “0 (Action depending on the valve action setting at STOP)” is set for the action when a Feedback resistance (FBR) input break occurs.

Data range	Factory set value
0: Close-side output OFF, Open-side output OFF	0
1: Close-side output ON, Open-side output OFF	
2: Close-side output OFF, Open-side output ON	

Related parameter

Engineering mode:

- Action at Feedback resistance (FBR) input error (P. 7-153)

F53.

**Action at saturated output**



Set to maintain ON state for the close-side (or open-side) output when the valve position is fully closed (or opened).

Data range	Factory set value
0: Invalid (The close-side [or open-side] output turns to OFF when the valve position is fully closed [or opened]).	0
1: Valid (The close-side [or open-side] output remains ON state when the valve position is fully closed [or opened]).	

Related parameter

Engineering mode:

- Action at Feedback resistance (FBR) input error (P. 7-153)

### ■ Description of function

#### [When the Action at saturated output is invalid]

The close-side output turns OFF when the valve position is fully closed (FBR input value  $\leq 0\%$ ). \*

The open-side output turns OFF when the valve position is fully opened (FBR input value  $\geq 100\%$ ). \*

#### [When the Action at saturated output is valid]

The close-side output remains ON when the valve position is fully closed (FBR input value  $\leq 0\%$ ). \*

The open-side output remains ON when the valve position is fully opened (FBR input value  $\geq 100\%$ ). \*

\* When controlling the valve position by Output limiter, the output limiter value becomes the close-side (or the open-side) output value.



**To validate the Action at saturated output, make sure to use valve with limit switch.**



Refer to the Action at Feedback resistance (FBR) input error for the valve action when the FBR input is broken.

## Function block 54 (F54.)

F54.

This is the first parameter symbol of Function block 54 (F54.).

F54.

### ST start condition

SFS

Timing (starting condition) to activate the Startup tuning (ST) function is selected.

Data range	Factory set value
0: Activate the Startup tuning (ST) function when the power is turned on; when transferred from STOP to RUN; or when the Set value (SV) is changed.	0
1: Activate the Startup tuning (ST) function when the power is turned on; or when transferred from STOP to RUN.	
2: Activate the Startup tuning (ST) function when the Set value (SV) is changed.	

Related parameter

Operation mode:

- Startup tuning (ST) (P. 7-16)

F54.

### ST proportional band adjusting factor

SFPB

This is a factor which is multiplied by the Proportional band computed by executing the Startup tuning (ST) function.

Data range	Factory set value
0.01 to 10.00 times	1.00

Related parameter

Operation mode:

- Startup tuning (ST) (P. 7-16)

F54.

**ST integral time adjusting factor**

This is a factor which is multiplied by the Integral time computed by executing the Startup tuning (ST) function.

Data range	Factory set value
0.01 to 10.00 times	1.00

Related parameter

Operation mode:

- Startup tuning (ST) (P. 7-16)

F54.

**ST derivative time adjusting factor**

This is a factor which is multiplied by the Derivative time computed by executing the Startup tuning (ST) function.

Data range	Factory set value
0.01 to 10.00 times	1.00

Related parameter

Operation mode:

- Startup tuning (ST) (P. 7-16)

## Function block 55 (F55.)

F55.

This is the first parameter symbol of Function block 55 (F55.).

F55.

### Automatic temperature rise group

Commu-  
nication  
OPTION

CHrG

Group No. when conducting an Automatic temperature rise.

Controllers with the same group numbers are collected in one group and the temperature is risen by other controllers so that they will synchronize with a controller whose temperature rise is slowest in that group.

Data range	Factory set value
0 to 16 (0: Automatic temperature rise function OFF)	0



The Automatic temperature rise function via Intercontroller communication is executed when the Communication 2 port is ready to be used and the Communication 2 protocol (CMP2) is set to “2: Intercontroller communication.”



If the group RUN/STOP function via Intercontroller communication is used, all of the controllers in one group can simultaneously start rising the temperature.



For the Automatic temperature rise, refer to **6.14.4 Automatic temperature rise function [with learning function] (P. 6-72)**.

#### Related parameters

Operation mode:

- Automatic temperature rise learning (P. 7-17)

Engineering mode:

- RUN/STOP group (P. 7-160)
- Automatic temperature rise dead time (P. 7-161)
- Automatic temperature rise gradient data (P. 7-161)
- Communication 2 protocol (P. 7-162)

F55.





**RUN/STOP group**

r50

Group No. when RUN/STOP transfer is made for each group.

Controllers with the same group numbers are collected in one group and RUN/STOP transfer is made for each group.

Data range	Factory set value
0 to 16 (0: RUN/STOP group function OFF)	0

-  The group RUN/STOP function via Intercontroller communication is executed when the Communication 2 port is ready to be used and the Communication 2 protocol (CMP2) is set to “2: Intercontroller communication.”
-  If even one controller in the same group is set to STOP (control stop) by Key operation, Communication or Digital input (DI), STOP (control stop) results.
-  If even one controller in the same group is set to RUN (control start) by Key operation, Communication or Digital input (DI), RUN (control start) results. However, no RUN results if there is even one controller whose Digital input (DI) is set to STOP.
-  If the group RUN/STOP function is used when an Automatic temperature rise via Intercontroller communication is made, all of the controllers in one group can simultaneously start rising the temperature.
-  For selecting group RUN/STOP, refer to **6.14.3 Group RUN/STOP function (P. 6-64)**.

**Related parameters**

Operation mode:

- RUN/STOP transfer (P. 7-21)

Engineering mode:

- Automatic temperature rise group (P. 7-159)
- Communication 2 protocol (P. 7-162)

F55.

## Automatic temperature rise dead time

Control response dead time of a controlled object. It is computed by Automatic temperature rise learning.

Data range	Factory set value
0.1 to 1999.9 seconds	10.0

The Automatic temperature rise dead time is also computed when the Startup tuning (ST) function [only when power is turned on] is executed.

For the Automatic temperature rise, refer to **6.14.4 Automatic temperature rise function [with learning function] (P. 6-72)**.

### Related parameters

Operation mode:

- Startup tuning (ST) (P. 7-16)
- Automatic temperature rise learning (P. 7-17)

Engineering mode:

- Automatic temperature rise group (P. 7-159)
- Automatic temperature rise gradient data (P. 7-161)

F55.

## Automatic temperature rise gradient data

This parameter is used to set the temperature change per one minute when the Automatic temperature rise is performed.

It is computed by Automatic temperature rise learning.

Data range	Factory set value
0.1 to Input span/minutes	1.0

The Automatic temperature rise gradient data is also computed when the Startup tuning (ST) function [only when power is turned on] is executed.

For the Automatic temperature rise, refer to **6.14.4 Automatic temperature rise function [with learning function] (P. 6-72)**.

### Related parameters

Operation mode:

- Startup tuning (ST) (P. 7-16)
- Automatic temperature rise learning (P. 7-17)

Engineering mode:

- Automatic temperature rise group (P. 7-159)
- Automatic temperature rise dead time (P. 7-161)

## Function block 60 (F60.)



This is the first parameter symbol of Function block 60 (F60.).  
The settings of parameters in this block become valid on the controller with the Communication function (optional).

F60.

### Communication 1 protocol Communication 2 protocol

Commu-  
nication  
OPTION

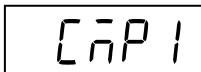

Communication 1 protocol:

Use to select the protocol for Communication 1 function.

Communication 2 protocol:

Use to select the protocol for Communication 2 function.

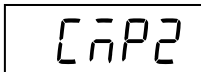

Data range	Factory set value
Communication 1 protocol: 0: RKC communication 1: Modbus 2: Intercontroller communication (Can only be selected when one-point communication is used on the FB100.)	0  If the Communication 1 protocol code is specified when the order is placed, the factory set value will be the same value as the Communication 1 protocol code.
Communication 2 protocol: 0: RKC communication 1: Modbus 2: Intercontroller communication	2



“2: Intercontroller communication” can be selected for the Communication 1 protocol when optional function E, F, H, or J is used.



For the Intercontroller communication, refer to **6.14 Group operation by the Intercontroller communication (P. 6-61)**.



For the Communication function, refer to the separate **FB100/FB400/FB900 Communication Instruction Manual (IMR01W04-E□)**.

#### Related parameters

Setup setting mode:

- Device address 1, Device address 2 (P. 7-47)
- Communication speed 1, Communication speed 2 (P. 7-48)
- Data bit configuration 1, Data bit configuration 2 (P. 7-49)
- Interval time 1, Interval time 2 (P. 7-50)

Engineering mode:

- External input type (P. 7-121)
- Automatic temperature rise group (P. 7-159)
- RUN/STOP group (P. 7-160)



---

## Function block 70 (F70.)

---



This is the first parameter symbol of Function block 70 (F70.).

F70.

### Setting change rate limiter unit time

---



Set the time unit for Setting change rate limiter (up/down).

Data range	Factory set value
1 to 3600 seconds	60

Related parameter

Parameter setting mode:

- Setting change rate limiter (up), Setting change rate limiter (down) (P. 7-34)

F70.

### Soak time unit

---

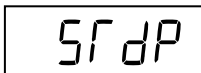

Use to select the time unit for Area soak time.

Data range	Factory set value
0: 0 hours 00 minutes to 99 hours 59 minutes	1
1: 0 minutes 00 seconds to 199 minutes 59 seconds	

Related parameter

Parameter setting mode:

- Area soak time (P. 7-35)

## Function block 71 (F71.)

F71.

This is the first parameter symbol of Function block 71 (F71.).

F71.

### Setting limiter high Setting limiter low

SLH

Setting limiter high: Use to set a high limit of the set value.

SLL

Setting limiter low: Use to set a low limit of the set value.

Data range	Factory set value
Setting limiter high: Setting limiter low to Input scale high Varies with the setting of the Decimal point position (P. 7-73).	Input scale high
Setting limiter low: Input scale low to Setting limiter high Varies with the setting of the Decimal point position (P. 7-73).	Input scale low

#### Related parameters

Engineering mode:

- Decimal point position (P. 7-73)
- Input scale high, Input scale low (P. 7-74)

#### ■ Description of function

Setting limiter is to set the range of the Set value (SV).

[Example] The input range (input scale range) is from 0 to 400 °C, the Setting limiter high is 200 °C, and the Setting limiter low is 20 °C.

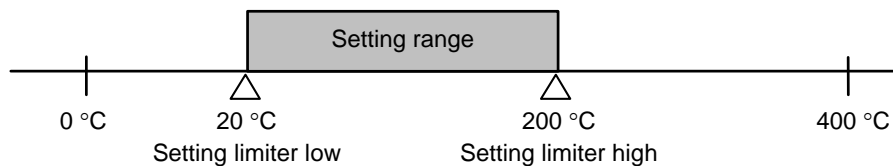

---

## Function block 91 (F91.)

---

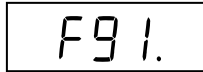

This is the first parameter symbol of Function block 91 (F91.).

F91.

### ROM version monitor

---

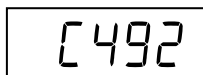

Displays the version of loaded software.

Display range	Factory set value
Version of ROM built in the controller	—

F91.

### Integrated operating time monitor

---

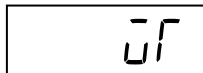

Displays the integrated total operating time of the controller.

Display range	Factory set value
0 to 19999 hours	—

F91.

### Holding peak value ambient temperature monitor

---

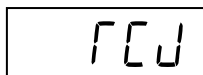

Displays the maximum ambient temperature of the instrument.

Display range	Factory set value
-10.0 to +100.0 °C	—

# **MEMO**

# TROUBLE SHOOTING

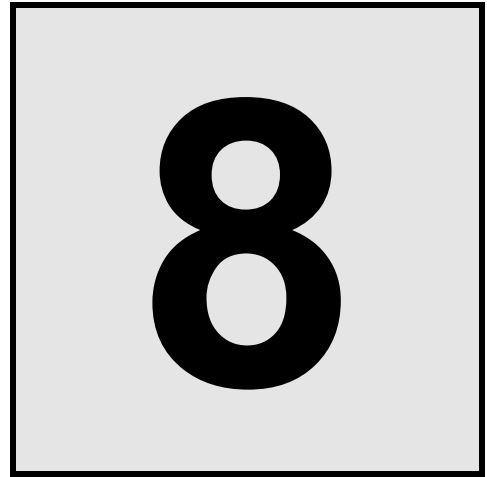

8.1 Error Display .....	8-2
8.2 Solutions for Problems.....	8-4

# 8.1 Error Display

This section describes error display when the Measured value (PV) exceeds the display range and the self-diagnostic error.

## ■ Display when input error occurs

The table below shows displays, description, control actions and solutions when the Measured value (PV) exceeds the display range.

 **Prior to replacing the sensor, always turn OFF the power or change to STOP with RUN/STOP transfer.**

Display	Description	Action (Output)	Solution
Measured value (PV) [Flashing]	<ul style="list-style-type: none"> <li>Measured value (PV) exceeds the Input scale high/low.</li> <li>Measured value (PV) exceeds the Input error determination point (high/low limit).</li> </ul>	<ul style="list-style-type: none"> <li>Action at input error: Output depending on the action at Input error (high/low limit) [Refer to page 7-131.]</li> </ul>	Check input type, input range, sensor and sensor connection.
0000 [Flashing]	Over-scale Measured value (PV) is above the display range limit high (or +19999).	<ul style="list-style-type: none"> <li>Event output: Output depending on the event action at input error</li> </ul>	
UUUU [Flashing]	Underscale Measured value (PV) is below the display range limit low (or -19999).		

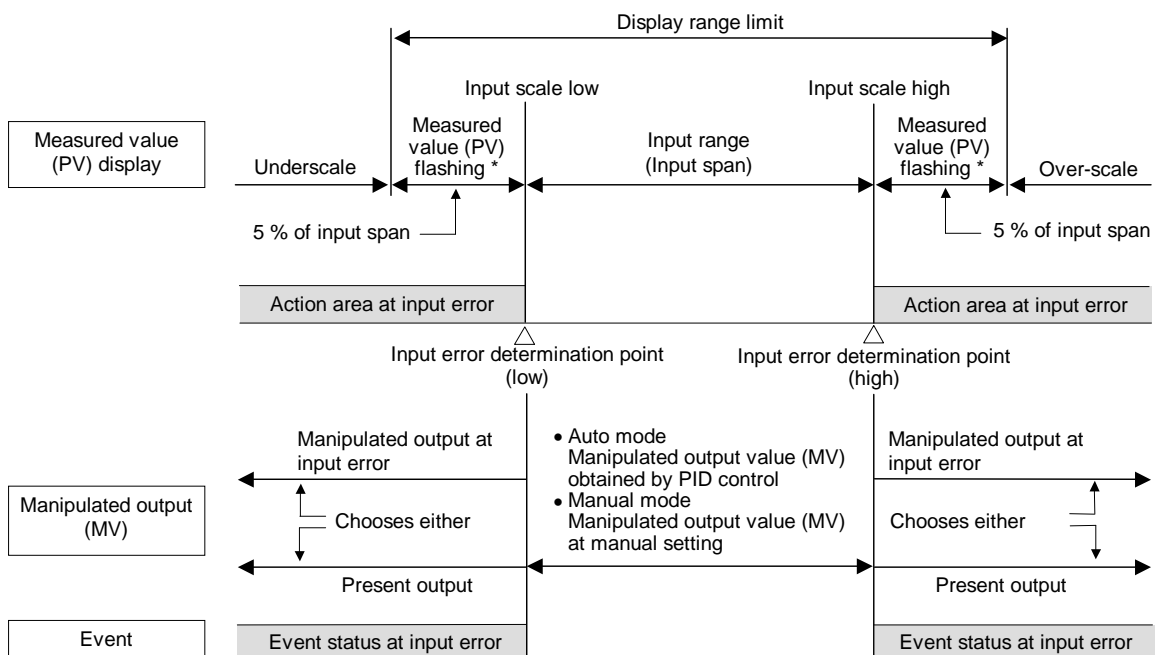

\* "Flashing display" or "Non-flashing display" of PV can be selected for the PV flashing display at input error of the Engineering Mode (F10).

### ■ Self-diagnostic error

In an error is detected by the Self-diagnostic function, the PV display shows “Err,” and the SV display shows the error code. If two or more errors occur simultaneously, the total summation of these error code is displayed.

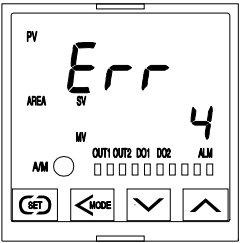
Error number	Description	Action	Solution
1	Adjusted data error • Adjusted data range is abnormal.	Display: Error display (Err)	Turn off the power at once.  If the FB100 is restored to normal after the power is turned on again, then probable cause may be external noise source affecting the control system. Check for the external noise source.  If an error occurs after the power is turned on again, the FB100 must be repaired or replaced. Please contact RKC sales office or the agent.
2	Back-up error • Back-up action is abnormal. • Data write failure	Output: All the output is OFF (Same as the power off)	
4	A/D conversion error • Response signal from A/D converter is abnormal.	Communication: Possible	
32	Custom data error • There is an abnormality on download data and it cannot execute.	<p>&lt;Example of error display&gt;</p> 	
128	Watchdog timer error • The part of an internal program stops the action.		
256	Stack overflow • Stack area of stack pointer overflows		
2048	Program error (busy) • Could not finish an internal program in a specified time.		

If any of the following errors occur, all action of the FB100 is stopped. In this case, the error number is not displayed.

Description	Action	Solution
Power supply voltage is abnormal (power supply voltage monitoring)	Display: All display is OFF Output: All output is OFF	The FB100 must be repaired or replaced.
RAM error (RAM check)	Communication: No response	Please contact RKC sales office or the agent.

## 8.2 Solutions for Problems

---

This section explains possible causes and solutions if any abnormality occurs in the instrument. For any inquiries or to confirm the specifications of the product, please contact RKC sales office or the agent.

If it is necessary to replace a device, always strictly observe the warnings below.



### WARNING

- To prevent electric shock or instrument failure, always turn off the system power before replacing the instrument.
- To prevent electric shock or instrument failure, always turn off the power before mounting or removing the instrument.
- To prevent electric shock or instrument failure, do not turn on the power until all wiring is completed. Make sure that the wiring is correct before applying power to the instrument.
- To prevent electric shock or instrument failure, do not touch the inside of the instrument.
- All wiring must be performed by authorized personnel with electrical experience in this type of work.

### CAUTION

All wiring must be completed before power is turned on to prevent electric shock, instrument failure, or incorrect action. The power must be turned off before repairing work for input break and output failure including replacement of sensor, contactor or SSR, and all wiring must be completed before power is turned on again.



## ■ Display

Problem	Possible cause	Solution
No display appears	The internal assembly is not inserted into the case correctly.	Insert the internal assembly into the case correctly.
	Power supply terminal connection not correct	Connect the terminals correctly by referring to <b>4.3 Wiring of Each Terminal (P. 4-6)</b> .
	Power supply terminal contact defect	Retighten the terminals
	Proper power supply voltage is not being supplied.	Apply the normal power supply by referring to <b>9. SPECIFICATIONS (P. 9-1)</b> .
Display is abnormal	Noise source is present near the instrument.	Separate the noise source from the instrument. Set the appropriate digital filter according to the responding control systems.
	The terminal board on the instrument using the thermocouple is directly exposed to the air from an air conditioner.	Do not directly expose the terminal board to the air from the air conditioner.
	Remote setting signal input is in parallel to two or more this instruments which use grounding type thermocouples.	Insert an isolator to enable isolated remote setting signal input for each instrument.
Measured value (PV) display differs from the actual value	Proper sensor is not being used.	Use the specified sensor.
	The PV bias is set.	Set the PV bias to "OFF" by referring to <b>PV bias (P. 7-43)</b> . However, this is limited only to when the PV bias setting can be changed.
	The PV ratio is set.	Change the PV ratio setting by referring to <b>PV ratio (P. 7-43)</b> . However, this is limited only to when the PV ratio setting can be changed.
Display value fluctuates	Setting of measured input sampling cycle is not appropriate. (Factory set value: 100 ms)	Set the appropriate sampling cycle by referring to <b>Sampling cycle (P. 7-78)</b> . However, this is limited only to when the sampling cycle setting can be changed.



How to check if the input function of the controller is working correctly.

- When the controller is configured as Thermocouple input:  
Short the input terminals No. 11 and No. 12. If the controller shows a Measured value around the ambient temperature of the input terminals, the input function of the controller is working correctly.
- When the controller is configured as RTD input:  
Connect a 100 Ω resistor between the input terminals No. 10 and No. 11 and short the input terminals No. 11 and No. 12. If the controller shows Measured value around 0 °C (32 °F), the input function of the controller is working correctly.
- When the controller is configured as Voltage/Current input:  
Input a certain voltage or current from a voltage/current generator to the controller. If the controller shows the equivalent input value, the input setting and function of the controller is working correctly.

### ■ Control

Problem	Possible cause	Solution
Control is abnormal	The power supply is not correct.	Apply the normal power supply by referring to <b>9. SPECIFICATIONS (P. 9-1)</b> .
	Sensor or input lead wires break.	Turn off the power or STOP the operation by “RUN/STOP transfer” and repair the sensor or replace it.
	The sensor is not wired correctly.	Conduct sensor wiring correctly by referring to <b>4.3 Wiring of Each Terminal (P. 4-6)</b> .
	Proper sensor is not being used.	Use the specified sensor.
	Sensor insertion depth is insufficient.	Check whether sensor is inserted too loosely. If so, fully insert the sensor.
	Sensor insertion position is not appropriate.	Insert the sensor at the specified location.
	Input signal wires are not separated from instrument power and/or load wires.	Separate each wire.
	Noise source is present near the wiring.	Separate the noise source from the wiring.
	Inappropriate PID constants	Set the appropriate PID constants.
Startup tuning (ST) function cannot be activated	Startup tuning (ST) mode is “oFF.” (Factory set value: oFF)	Refer to <b>6.6 Startup Tuning (ST) (P. 6-18)</b> .
	Requirements for performing the Startup tuning (ST) function are not satisfied.	Satisfy the requirements for performing the Startup tuning (ST) function by referring to <b>6.6 Startup Tuning (ST) (P. 6-18)</b> .
Autotuning (AT) function not activated	Requirements for performing the Autotuning (AT) function are not satisfied.	Satisfy the requirements for performing the Autotuning (AT) function by referring to <b>6.5 Autotuning (AT) (P. 6-15)</b> .
Autotuning (AT) suspended	Requirements for suspending the Autotuning (AT) function are established.	Identify causes for Autotuning (AT) suspension by referring to <b>6.5 Autotuning (AT) (P. 6-15)</b> and then remove them. Then, execute the Autotuning (AT) function again.

Continued on the next page.

Continued from the previous page.

Problem	Possible cause	Solution
Acceptable PID values can not be computed by Autotuning (AT)	The Autotuning (AT) function does not appropriately meet the characteristics of the controlled object.	Set PID constants manually.
	The Output change rate limiter is set.	Set PID constants manually.
		Set the Output change rate limiter to "0.0: OFF" by referring to <b>Output change rate limiter (up/down) (P. 7-133)</b> . However, this is limited only to when the Output change rate limiter setting can be changed.
Autotuning (AT) cannot be finished normally	A temperature change (UP and/or Down) is 1 °C or less per minute during Autotuning.	Set PID constants manually.
	Autotuning (AT) is activated when the set value is around the ambient temperature or is close to the maximum temperature achieved by the load.	
No output change in step	The Output change rate limiter is set.	Set the Output change rate limiter to "0.0: OFF" by referring to <b>Output change rate limiter (up/down) (P. 7-133)</b> . However, this is limited only to when the Output change rate limiter setting can be changed.
Output does not change	The Output limiter is set.	Change the Output limiter setting by referring to <b>Output limiter high/low (P. 7-135)</b> . However, this is limited only to when the Output limiter setting can be changed.

### ■ Operation

Problem	Possible cause	Solution
No control RUN can be made by key operation.	RUN/STOP transfer of the Digital input (DI) is set to the contact opened.	Check the contact state of RUN/STOP transfer by referring to <b>6.4 RUN/STOP Transfer (P. 6-11)</b> .
No Manual mode can be made by key operation.	Auto/Manual transfer of the Digital input (DI) is set to the contact opened.	Check the contact state of Auto/Manual transfer by referring to <b>6.7 Auto/Manual Transfer (P. 6-23)</b> .
No Remote mode can be made by key operation.	Remote/Local transfer of the Digital input (DI) is set to the contact opened.	Check the contact state of Remote/Local transfer by referring to <b>6.8 Remote/Local Transfer (P. 6-29)</b> .
No control area transfer can be made by key operation.	Control area transfer of the Digital input (DI) is set to the contact opened.	Check the contact state of control area transfer by referring to <b>6.9 Control Area Transfer (P. 6-33)</b> .
No setting change can be made by key operation.	Set data is locked.	Release the Set data lock by referring to <b>Set lock level (P. 7-51)</b> .
Set value (SV) does not change.	The Setting limiter is set.	Change the Setting limiter setting by referring to <b>Setting limiter high/low (P. 7-164)</b> . However, this is limited only to when the Setting limiter setting can be changed.
Set value (SV) does not change immediately when the Set value (SV) is changed.	The Setting change rate limiter is set.	Set the Setting change rate limiter to "OFF" by referring to <b>Setting change rate limiter (up/down) (P. 7-34)</b> . However, this is limited only to when the Setting limiter setting can be changed.
Remote setting (RS) input value display differs from the actual value.	The RS bias is set.	Set the RS bias to "OFF" by referring to <b>RS bias (P. 7-45)</b> . However, this is limited only to when the RS bias setting can be changed.
	The RS ratio is set.	Change the RS ratio setting by referring to <b>RS ratio (P. 7-45)</b> . However, this is limited only to when the RS ratio setting can be changed.

### ■ Event function

Problem	Possible cause	Solution
Event function is abnormal	Event function is different from the specification.	Change the Event action type by referring to <b>Event 1 type (P. 7-88)</b> , <b>Event 2 type (P. 7-97)</b> , <b>Event 3 type (P. 7-101)</b> , or <b>Event 4 type (P. 7-105)</b> after the instrument specification is confirmed.
	Digital output (DO) relay contact Energized/De-energized is reversed.  When FAIL is selected for digital output: De-energized fixed: Contact opens under FAIL	Check the setting details by referring to <b>Energized/De-energized (P. 7-83)</b> .
	Setting of Event differential gap is not appropriate.	Set the appropriate Event differential gap by referring to <b>Event differential gap (P. 7-93, P. 7-99, P. 7-103, P. 7-109)</b> .
No output of the Event function is turned on	Event function is not assigned to the Digital output (DO).	Check the contents of Output assignment by referring to <b>Output assignment (P. 7-82)</b> .
Event hold action is not activated.	The Setting change rate limiter is set.	Set the Setting change rate limiter to "OFF" by referring to <b>Setting change rate limiter (up/down) (P. 7-34)</b> . However, this is limited only to when the Setting limiter setting can be changed.

---



---

**■ Heater break alarm (HBA)**

<b>Problem</b>	<b>Possible cause</b>	<b>Solution</b>
No heater break can be detected	Setting of Heater break alarm is not appropriate.	Set the appropriate Heater break alarm value.
	The CT is not connected.	Connect the CT by referring to <b>4.3 Wiring of Each Terminal (P. 4-6)</b> .
CT input value is abnormal	Proper CT is not used.	Use the specified CT.
	The heater is broken.	Check the heater.
	CT wiring improperly.	Conduct CT wiring correctly by referring to <b>4.3 Wiring of Each Terminal (P. 4-6)</b> .
	Input terminal contact defect.	Retighten the terminals

# **SPECIFICATIONS**



■ Measured input

Number of input: 1 point

Input type: **Temperature, Current and Voltage (low) group \***

Thermocouple (TC):

K, J, T, S, R, E, B, N (JIS-C1602-1995)

PL II (NBS), W5Re/W26Re (ASTM-E988-96)

U, L (DIN43710-1985)

RTD: Pt100 (JIS-C1604-1997)

JPt100 (JIS-C1604-1997, JIS-C1604-1981 of Pt100)

3-wire system

Voltage: 0 to 10 mV DC, -10 to +10 mV DC, 0 to 100 mV DC,  
-100 to +100 mV DC, 0 to 1 V DC

Current: 4 to 20 mA DC, 0 to 20 mA DC

**Voltage (high) group \***

Voltage: -1 to +1 V DC, 0 to 5 V DC, 1 to 5 V DC, 0 to 10 V DC

\* Universal input (Use the input select switch to change input group.)

Input range:

TC input

Input type	Measured range
K	-200.0 to +400.0 °C, -200.0 to +800.0 °C, -200 to +1372 °C, -328.0 to +400.0 °F, -250.0 to +800.0 °F, -328 to +2502 °F
J	0.0 to 400.0 °C, -200.0 to +400.0 °C, -200.0 to +800.0 °C, -200 to +1200 °C, -200.0 to +700.0 °F, -328.0 to +1200.0 °F, -328 to +2192 °F
T	-200.0 to +400.0 °C, -328.0 to +752.0 °F
S, R	-50 to +1768 °C, -58 to +3214 °F
E	-200.0 to +700.0 °C, -200 to +1000 °C, -328.0 to +1292.0 °F, -328 to +1832 °F
B	0 to 1800 °C, 0 to 3272 °F
N	0 to 1300 °C, 0 to 2372 °F
PLII	0 to 1390 °C, 0 to 2534 °F
W5Re/W26Re	0 to 2300 °C, 0 to 4200 °F
U	0.0 to 600.0 °C, 32.0 to 1112.0 °F
L	0.0 to 900.0 °C, 32.0 to 1652.0 °F

RTD input

Input type	Measured range
Pt100	-100.00 to +100.00 °C, -200.0 to +850.0 °C, -199.99 to +199.99 °F, -328.0 to +1562.0 °F
JPt100	-100.00 to +100.00 °C, -200.0 to +640.0 °C, -199.99 to +199.99 °F, -328.0 to +1184.0 °F

Voltage/Current input

Input type		Measured range
Voltage (low)	0 to 10 mV DC, -10 to +10 mV DC, 0 to 100 mV DC, -100 to +100 mV DC 0 to 1 V DC	Programmable range (-19999 to +19999)
Voltage (high)	-1 to +1 V DC, 0 to 5 V DC, 1 to 5 V DC, 0 to 10 V DC	
Current	0 to 20 mA DC, 4 to 20 mA DC	



---



---

<b>Sampling cycle:</b>	100 ms±0.3% (50 ms±5% or 250 ms±0.3% is selectable)
<b>Influence of external resistance:</b>	Approx. 0.2 μV/Ω (Converted depending on TC types)
<b>Influence of input lead:</b>	Approx. 0.01 %/Ω of PV (RTD input) 10 Ω or less per wire
<b>Input impedance:</b>	TC input: 1 MΩ or more Voltage (low) input: 1 MΩ or more Voltage (high) input: Approx. 1 MΩ Current input: Approx. 50 Ω
<b>Sensor current:</b>	Approx. 250 μA (RTD input)
<b>Action at input break:</b>	TC input: Upscale or Downscale RTD input: Upscale Voltage (low) input: Upscale or Downscale Voltage (high) input: Downscale (Indicates value near 0 V) Current input: Downscale (Indicates value near 0 mA)
<b>Action at input short circuit:</b>	Downscale (RTD input)
<b>Action at input error:</b>	Setting range of Input error determination point (high/low): Input scale low – (5 % of input span) to Input scale high + (5 % of input span) High/Low individual setting Manipulated output value at input error: –105.0 to +105.0 %
<b>Input correction:</b>	PV bias: –Input span to +Input span PV ratio: 0.500 to 1.500 First order lag digital filter: 0.0 to 100.0 seconds (0.0: OFF)
<b>Square root extraction function (Voltage input, Current input):</b>	Calculation method: Measured value = √ (Input value × PV ratio + PV bias) PV low input cut-off: 0.00 to 25.00 % of input span

#### ■ Remote setting (RS) input [optional]

<b>Number of input:</b>	1 point (Not isolated from measured input)
<b>Input type:</b>	Voltage (low) input: 0 to 10 mV DC, 0 to 100 mV DC, 0 to 1 V DC Voltage (high) input: 0 to 5 V DC, 1 to 5 V DC, 0 to 10 V DC Current input: 0 to 20 mA DC, 4 to 20 mA DC
<b>Sampling cycle:</b>	200 ms (twice of the measured input sampling cycle) 100 ms (twice of the measured input sampling cycle) 500 ms (twice of the measured input sampling cycle)
<b>Input impedance:</b>	Voltage (low) input: 1 MΩ or more Voltage (high) input: Approx. 1 MΩ Current input: Approx. 50 Ω

---

<b>Action at input break:</b>	Voltage input:	Downscale (Indicates value near 0 V)
	Current input:	Downscale (Indicates value near 0 mA)
<b>Input correction:</b>	RS bias:	-Input span to +Input span
	RS ratio:	0.001 to 9.999
	RS digital filter (first order lag):	0.0 to 100.0 seconds (0.0: OFF)
<b>Allowable input voltage:</b>	Voltage (low) input:	Within $\pm 3.5$ V
	Voltage (high) input:	Within $\pm 12$ V

### ■ Current transformer (CT) input [optional]

<b>Number of inputs:</b>	Up to 2 points
<b>CT type:</b>	CTL-6-P-N or CTL-12-S56-10-N (Sold separately)
<b>Input range:</b>	CTL-6-P-N: 0.0 to 30.0 A
	CTL-12-S56-10L-N: 0.0 to 100.0 A
<b>Sampling cycle:</b>	200 ms (twice of the measured input sampling cycle)
	100 ms (twice of the measured input sampling cycle)
	500 ms (twice of the measured input sampling cycle)
<b>CT ratio:</b>	0 to 9999
	CTL-6-P-N: 800
	CTL-12-S56-10L-N: 1000

#### **Automatic power frequency detection:**

Power frequency can be set by automatic detection.  
However, no frequency may be able to be detected if at a CT value of less than 0.5 A.

### ■ Feedback resistance (FBR) input [optional]

<b>Number of input:</b>	1 point
<b>Permissible resistance range:</b>	100 $\Omega$ to 10 k $\Omega$ (Standard: 135 $\Omega$ )
<b>Input range:</b>	0.0 to 100.0 % (for adjustment span of open and close)
<b>Sampling cycle:</b>	200 ms (twice of the measured input sampling cycle)
	100 ms (twice of the measured input sampling cycle)
	500 ms (twice of the measured input sampling cycle)
<b>Action at FBR break:</b>	Upscale

### ■ Digital input (DI) [optional]

<b>Number of inputs:</b>	Up to 5 points (DI1 to DI5)
<b>Input method:</b>	Dry contact input
	Open state: 500 k $\Omega$ or more
	Close state: 10 $\Omega$ or less
	Contact current: 5 mA or less
	Voltage at open: Approx. 5 V DC
<b>Capture judgment time:</b>	200 ms

### ■ Output (OUT1, OUT2)

<b>Number of outputs:</b>	Up to 2 points (Output 1, Output 2)
<b>Output contents:</b>	Used for control output or digital output (DO) (Specify when ordering)
<b>Output type:</b>	<b>Relay contact output</b>
	Contact type: 1a contact
	Contact rating (Resistive load): 250 V AC 3 A, 30 V DC 1 A
	Electrical life: 100,000 times or more (Rated load) (Switching: 10 times/min)
	Mechanical life: 20 million times or more (Switching: 300 times/min)
	<b>Voltage pulse output</b>
	Output voltage: 0/12 V DC (Rating) ON voltage: 11 V or more, 13 V or less OFF voltage: 0.2 V or less
	Allowable load resistance: 600 $\Omega$ or more
	<b>Current output</b>
	Output current (Rating): 4 to 20 mA DC, 0 to 20 mA DC
	Output range: 1 to 21 mA DC, 0 to 21 mA DC
	Allowable load resistance: 600 $\Omega$ or less
	Output impedance: 1 M $\Omega$ or more
	<b>Voltage output</b>
	Output voltage (Rating): 0 to 10 V DC, 0 to 5 V DC, 1 to 5 V DC
	Output range: -0.5 to +10.5 V DC, -0.25 to +5.25 V DC, 0.8 to 5.2 V DC
	Allowable load resistance: 1 k $\Omega$ or more
	Output impedance: 0.1 $\Omega$ or less
	<b>Triac output</b>
	Output method: AC output (Zero-cross method)
	Allowable load current: 0.5 A (Ambient temperature 40 °C or less) Ambient temperature 50 °C: 0.3 A
	Load voltage: 75 to 250 V AC
	Minimum load current: 30 mA
	ON voltage: 1.6 V or less (at maximum load current)

**Open collector output**

Output method:	Sink type
Allowable load current:	100 mA
Load voltage:	30 V DC or less
Minimum load current:	0.5 mA
ON voltage:	2 V or less (at maximum load current)
Leakage current at OFF:	0.1 mA or less

**■ Digital output (DO1, DO2)**

**Number of outputs:** 2 points

**Output contents:** Used only for the event function (Specify when ordering)

**Output type:** **Relay contact output**

Contact type:	1a contact
Contact rating (Resistive load):	250 V AC 1 A, 30 V DC 1 A
Electrical life:	300,000 times or more (Rated load) (Switching: 10 times/min)
Mechanical life:	20 million times or more (Switching: 300 times/min)

**■ Transmission output (AO) [optional]**

**Number of outputs:** 1 point

**Output contents:** Measured value (PV), Set value (SV) monitor, Deviation value, Set value (SV), Manipulated output (MV1) [heat-side]<sup>1,2</sup>, Manipulated output (MV2) [cool-side]<sup>3</sup>, Remote setting (RS) input value

<sup>1</sup> Heat/Cool PID control: Output value [heat-side]

<sup>2</sup> Position proportioning PID control: Feedback resistance input value

<sup>3</sup> Output value [cool-side] in Heat/Cool PID control

**Output type:** **Voltage output**

Output voltage (Rating): 0 to 10 V DC, 0 to 5 V DC, 1 to 5 V DC, 0 to 1 V DC

Output range: -0.5 to +10.5 V DC, -0.25 to +5.25 V DC, 0.8 to 5.2 V DC, -0.05 to +1.05 V DC

Allowable load resistance: 1 k $\Omega$  or more

Output impedance: 0.1  $\Omega$  or less

**Current output**

Output current (Rating): 4 to 20 mA DC, 0 to 20 mA DC

Output range: 1 to 21 mA DC, 0 to 21 mA DC

Allowable load resistance: 600  $\Omega$  or less

Output impedance: 1 M $\Omega$  or more

**Output scaling:** High/Low individual setting

Measured value (PV): Input scale low to Input scale high

Deviation value: -Input span to +Input span

Set value (SV) monitor: Input scale low to Input scale high

Remote setting (RS) input value: Input scale low to Input scale high

Manipulated output value (MV1) [heat-side]: -5.0 to +105.0 %

Manipulated output value (MV2) [cool-side]: -5.0 to +105.0 %

■ **Performance (at the ambient temperature  $23 \pm 2$  °C):**

**Input accuracy:**

**Measured input:**

[For Fahrenheit: Converted value of Celsius]

Input type	Input range	Accuracy
K, J, T, PLH, E, U, L	Less than $-100$ °C	$\pm 1.0$ °C
	$-100$ °C or more, less than $+500$ °C	$\pm 0.5$ °C
	$500$ °C or more	$\pm(0.1$ % of Reading +1 digit)
S, R, N, W5Re/W26Re	Less than $0$ °C	$\pm 2.0$ °C
	$0$ °C or more, less than $1000$ °C	$\pm 1.0$ °C
	$1000$ °C or more	$\pm(0.1$ % of Reading +1 digit)
B	Less than $400$ °C	$\pm 70.0$ °C
	$400$ °C or more, less than $1000$ °C	$\pm(1.4$ °C +1 digit)
	$1000$ °C or more	$\pm(0.1$ % of Reading +1 digit)
Pt100, JPt100	Less than $200$ °C	$\pm 0.2$ °C
	$200$ °C or more	$\pm(0.1$ % of Reading +1 digit)
Voltage input	$\pm 0.1$ % of input span	
Current input		

**Remote setting (RS) input:**

Voltage input:  $\pm 0.1$  % of input span

Current input:  $\pm 0.1$  % of input span

**Current transformer (CT) input:**

$\pm 5$  % of Reading  $\pm 1$  digit or  $\pm 2$  A (whichever is larger)

**Feedback resistance (FBR) input:**

$\pm 0.5$  %  $\pm 1$  digit of input span (for adjustment span of open and close)

**Output accuracy:**

Current output:  $\pm 3$  % of span (Output 1, Output 2)

$\pm 0.1$  % of span (Transmission output)

Voltage output:  $\pm 3$  % of span (Output 1, Output 2)

$\pm 0.1$  % of span (Transmission output)

**Cold-junction temperature compensation error:**

Within  $\pm 1.0$  °C

Within  $\pm 1.5$  °C (Between  $-10$  to  $+50$  °C)

**Close horizontal mounting error:**

Within  $\pm 1.5$  °C

**Influence of physical orientation ( $\pm 90^\circ$ ):**

**Input:** TC input:  $\pm 0.3$  % of input span or  $\pm 3.0$  °C or less

RTD input:  $\pm 0.5$  °C or less

Voltage/Current input:

Less than  $\pm 0.1$  % of input span

**Output:** Less than  $\pm 0.3$  % of output span

## ■ Control

- Control method:**
- a) Brilliant II PID control (Direct/Reverse action is selectable)
  - b) Brilliant II Heat/Cool PID control
  - c) Brilliant II Position proportioning PID control without FBR (Direct/Reverse action is selectable)
- a), b), c) is selectable
- Autotuning:**
- For PID control (Direct/Reverse action)
  - For Heat/Cool PID control (for Extruder [air cooling])
  - For Heat/Cool PID control (for Extruder [water cooling])
  - For Heat/Cool PID control
- Startup tuning (ST):** When in Heat/Cool PID control, it is possible to execute the Startup tuning (ST) function only in the temperature rise direction.  
The PID values on the heat side are automatically computed.  
Becomes invalid when in Position proportioning PID control.

## ■ Brilliant II PID control

- Setting range:**
- a) Proportional band (P) \*
    - Temperature input: 0 to Input span (unit: °C [°F])
    - Voltage/Current input: 0.0 to 1000.0 % of input span
    - \* 0 [0.0]: ON/OFF action  
ON/OFF action differential gap:
      - Temperature input: 0.0 to Input span (unit: °C [°F])
      - Voltage/Current input: 0.0 to 10.0 % of input span
  - b) Integral time (I): 0 to 3600 seconds or 0.0 to 1999.9 seconds  
(0 [0.0]: Integral action OFF)
  - c) Derivative time (D): 0 to 3600 seconds or 0.0 to 1999.9 seconds  
(0 [0.0]: Derivative action OFF)
  - d) Control response parameter:
    - Slow, Medium and Fast (3-step selection)
  - e) Proportional cycle time: 0.1 to 100.0 seconds
  - f) Output limiter high/low: -5.0 to +105.0 %
    - Output limiter low ≤ Output limiter high
    - High/Low individual setting
  - g) Output change rate limiter (up/down):
    - 0.0 to 100.0 %/seconds of manipulated output
    - (0.0: Output change rate limiter OFF)
    - Up/Down individual setting
  - h) Manual reset: -100.0 to +100.0 %
  - i) Manual output: Output limiter low to Output limiter high
  - j) Manipulated output value at (MV) at STOP mode:
    - 5.0 to +105.0 %

## ■ Brilliant II Heat/Cool PID control

- Setting range:**
- a) Proportional band (P) \*
    - Temperature input: 0 to Input span (unit: °C [°F])
    - Voltage/Current input: 0.0 to 1000.0 % of input span
    - \* 0 [0.0]: ON/OFF action
    - ON/OFF action differential gap:
      - Temperature input: 0.0 to Input span (unit: °C [°F])
      - Voltage/Current input: 0.0 to 10.0 % of input span
  - b) Integral time (I): 0 to 3600 seconds or 0.0 to 1999.9 seconds  
(0 [0.0]: Integral action OFF)
  - c) Derivative time (D): 0 to 3600 seconds or 0.0 to 1999.9 seconds  
(0 [0.0]: Derivative action OFF)
  - d) Proportional band [cool-side]:
    - Temperature input: 1 (0.1 or 0.01) to Input span (unit: °C [°F])
    - Voltage/Current input: 0.1 to 1000.0 % of input span
  - e) Integral time [cool-side]: 0 to 3600 seconds or 0.0 to 1999.9 seconds  
(0 [0.0]: Integral action OFF)
  - f) Derivative time [cool-side]: 0 to 3600 seconds or 0.0 to 1999.9 seconds  
(0 [0.0]: Derivative action OFF)
  - g) Overlap/Deadband:
    - Temperature input: –Input span to +Input span (unit: °C [°F])
    - Voltage/Current input: –100.0 to +100.0 % of input span
    - Minus (–) setting results in overlap.  
(However, the overlapping range is within the proportional range.)
  - h) Control response parameter: Slow, Medium and Fast (3-step selection)
  - i) Proportional cycle time: 0.1 to 100.0 seconds
  - j) Proportional cycle time [cool-side]: 0.1 to 100.0 seconds
  - k) Output limiter high/low: –5.0 to +105.0 %  
Output limiter low ≤ Output limiter high  
High/Low individual setting
  - l) Output change rate limiter (up/down): 0.0 to 100.0 %/seconds of manipulated output  
(0.0: Output change rate limiter OFF)  
Up/Down individual setting
  - m) Manual reset: –100.0 to +100.0 %
  - n) Manual output: –Output limiter high [cool-side] to  
Output limiter high [heat-side]  
For overlap: –105.0 to +105.0 % \*  
\* Actual output value is limited by the output limiter function.
  - o) Manipulated output value at (MV) at STOP mode: –5.0 to +105.0 %  
Heat-side/Cool-side individual setting
  - p) Overlap/Deadband reference point: 0.0 to 1.0 (0.0: Proportional band on heat-side)

## ■ Brilliant II Position proportioning PID control without FBR

### Setting range:

- a) Proportional band (P) \*
- Temperature input: 0 to Input span (unit: °C [°F])
  - Voltage/Current input: 0.0 to 1000.0 % of input span
- \* 0 [0.0]: ON/OFF action  
ON/OFF action differential gap:
- Temperature input: 0.0 to Input span (unit: °C [°F])
  - Voltage/Current input: 0.0 to 10.0 % of input span
- b) Integral time (I): 1 to 3600 seconds or 0.1 to 1999.9 seconds
- c) Derivative time (D): 0 to 3600 seconds or 0.0 to 1999.9 seconds
- d) Control response parameter:  
Slow, Medium, Fast (3-step selection)
- e) Control motor time: 5 to 1000 seconds
- f) Output limiter high/low:  
-5.0 to +105.0 %  
Output limiter low ≤ Output limiter high  
Invalid when Feedback resistance (FBR) input is broken.
- g) Integrated output limiter:  
0.0 to 200.0 % of control motor time  
Invalid when Feedback resistance (FBR) input is used.
- h) Open/Close output neutral zone:  
0.1 to 10.0 %
- i) Open/Close output differential gap:  
0.1 to 5.0 %
- j) Manipulated output value (MV) at STOP mode:  
-5.0 to +105.0 %  
When Feedback resistance (FBR) input is provided, and it is not input break.
- k) Valve action at STOP:
- ① Close-side output OFF, Open-side output OFF
  - ② Close-side output ON, Open-side output OFF
  - ③ Close-side output OFF, Open-side output ON
- Selectable when Feedback resistance (FBR) input is not specified or when it is specified but broken.
- l) Manual output:  
When there is a Feedback resistance (FBR) input:  
Output limiter low to Output limiter high  
When there is no Feedback resistance (FBR) input:  
It is possible to set the output ON/OFF by pressing the UP or DOWN key.



m) Action at saturated output:

0 (Invalid), 1 (Valid)

When the Action at saturated output is valid:

- The close-side output remains ON when the valve position is fully closed
- The open-side output remains ON when the valve position is fully opened

To validate the Action at saturated output, make sure to use valve with limit switch.

### ■ Event function [optional]

<b>Number of events:</b>	Up to 4 points (Event function 1 to 4)
<b>Event action:</b>	Deviation high, Deviation low, Deviation high/low, Band, Process high, Process low, SV high, SV low, MV1 high [heat-side]*, MV1 low [heat-side]*, MV2 high [cool-side], MV2 low [cool-side] * Position proportioning PID control: Feedback resistance (FBR) input value
<b>Setting range:</b>	<p><b>Deviation:</b></p> <ul style="list-style-type: none"> <li>• Event setting: -Input span to +Input span</li> <li>• Differential gap: 0 to Input span</li> </ul> <p><b>Process:</b></p> <ul style="list-style-type: none"> <li>• Event setting: Same as input range</li> <li>• Differential gap: 0 to Input span</li> </ul> <p><b>SV:</b></p> <ul style="list-style-type: none"> <li>• Event setting: Same as input range</li> <li>• Differential gap: 0 to Input span</li> </ul> <p><b>MV:</b></p> <ul style="list-style-type: none"> <li>• Event setting: -5.0 to +105.0 %</li> <li>• Differential gap: 0.0 to 110.0 %</li> </ul>
<b>Output method:</b>	Assignable to digital output (DO1, DO2)
<b>Additional function:</b>	<p>Hold action: Hold action is selectable from Hold action OFF, Hold action ON, and Re-hold action ON. Valid only when the event action (Process, Deviation, or MV) is selected.</p> <p>Delay timer: 0.0 to 600.0 seconds</p> <p>Event action at input error: Event action type is selectable</p> <p>Interlock: Use/Unuse is selectable</p>

### ■ Control loop break alarm (LBA) [optional]

<b>Selection method:</b>	LBA is assignable to Event function 4. (Heat/Cool PID control: LBA is not selectable)
<b>Setting range:</b>	LBA time: 0 to 7200 seconds (0: LBA function OFF) LBA deadband (LBD): 0 to Input span

### ■ Heater break alarm (HBA) [time-proportional control output (optional)]

<b>Number of HBA:</b>	Up to 2 points (1 point per CT input)
<b>Setting range:</b>	0.0 to 100.0 A (0.0: HBA function OFF) [HBA function OFF: The current value monitoring is available] CT assignment: 0 to 6 (0: HBA function OFF)
<b>Output method:</b>	Assignable to Output 2 or Digital output 1, 2 (DO1, DO2)
<b>Additional function:</b>	Number of HBA delay times: 0 to 255 times

### ■ Heater break alarm (HBA) [continuous control output (optional)]

<b>Number of HBA:</b>	Up to 2 points (1 point per CT input)
<b>Setting range:</b>	0.0 to 100.0 A (0.0: HBA function OFF) [HBA function OFF: The current value monitoring is available] Heater break determination point: 0.0 to 100.0 % of HBA set value (0.0: HBA function OFF) Heater melting determination point: 0.0 to 100.0 % of HBA set value (0.0: HBA function OFF) CT assignment: 0 to 6 (0: HBA function OFF)
<b>Output method:</b>	Assignable to Output 2 or Digital output 1, 2 (DO1, DO2)

### ■ Multi-memory area function

<b>Number of areas:</b>	8 points
<b>Stored parameters:</b>	Set value (SV), Event function 1 to 4, LBA time, LBA deadband, Proportional band, Integral time, Derivative time, Control response parameter, Proportional band [cool-side], Integral time [cool-side], Derivative time [cool-side], Overlap/Deadband, Manual reset, Setting change rate limiter (up), Setting change rate limiter (down), Soak time setting, Link area number
<b>Method of area transfer:</b>	AREA key operation (only Direct key type 1) Communication function (optional) Event input DI1 to 4 (optional) Area soak time

**Memory area link function:**

Link area number: 0 to 8 (0: No link)  
 Soak time: 00 minutes 00 seconds to 199 minutes 59 seconds  
 or 00 hours 00 minutes to 99 hours 59 minutes  
 (Selectable)  
 Accuracy:  $\pm 0.3$  % of set value +1 sampling time

**■ Loader communication**

**Loader communication:** For RKC communication protocol only  
**Synchronous method:** Start/Stop synchronous type  
**Communication speed:** 38400 bps  
**Data format:** Start bit: 1  
 Data bit: 8  
 Parity bit: Without  
 Stop bit: 1  
**Protocol:** ANSI X3.28-1976 subcategories 2.5 and A4  
**Maximum number of connection points:**  
 1 point (Only COM-K)  
 Address setting: Controller address is fixed at 0.  
**Connection method:** COM-K special cable (W-BV-01-1500)  
**Interval time:** 0 ms  
**Other:**

- ① Power supply from COM-K is possible  
 However, this is only for operation to change internal set values, and thus control turns OFF (outputs are off and relays are open) and Host communication stops. The PV/SV display shows “----”.
- ② When the instrument power is turned on after power is supplied from COM-K, the instrument starts by reset and operates normally.
- ③ When power is supplied from the instrument, Loader communication can be used simultaneously with Host communication.

**■ Communication [optional]****● Communication 1 (for Host communication or intercontroller communication \*)**

**Interface:** Based on RS-485, EIA standard  
 Multi-drop connection of RS-485 is available.  
**Protocol:** RKC communication (ANSI X3.28-1976 subcategories 2.5 and A4)  
 Modbus-RTU  
 \* When two-point communication is provided, Communication 1 must be used as Host communication.

---

- **Communication 2 (for Intercontroller communication)**

**Interface:** Based on RS-485, EIA standard

**Protocol:** Intercontroller communication protocol  
 Also Communication 2 can be used as the Host communication  
 (Protocol type selection is selectable [Engineering mode])  
 If you use Communication 2 function, two-point communication must be provided.

- **Intercontroller communication function [optional]**

- **Automatic temperature rise**

**Setting range:** Automatic temperature rise group:  
 0 to 16 (0: Automatic temperature rise function OFF)

Automatic temperature rise learning:  
 0 (Unused), 1 (Learning)

Automatic temperature rise dead time:  
 0.1 to 1999.9 seconds

Automatic temperature rise gradient data:  
 0.1 to Input span/minute

- **Cascade control**

**Setting range:** Master channel selection:  
 0 to 31  
 (Communication address of master channel)

Cascade bias: Common to RS bias setting

Cascade ratio: Common to RS ratio setting

Cascade filter: Common to RS digital filter setting (0: Filter OFF)

- **Ratio setting**

**Setting range:** Master channel selection:  
 0 to 31  
 (Communication address of master channel)

Ratio setting bias: Common to RS bias setting

Ratio setting ratio: Common to RS ratio setting

Ratio setting filter: Common to RS digital filter setting (0: Filter OFF)

- **Group RUN/STOP function**

**Setting range:** RUN/STOP group: 0 to 16 (0: Group RUN/STOP function OFF)

## ■ Self-diagnostic function

### Control stop (Error number is displayed [Operation: Possible]):

Adjustment data error (Err 1),  
 Back-up error (Err 2),  
 A/D conversion error (Err 4),  
 Custom data error (Err 32),  
 Watchdog timer error (Err 128),  
 Stack overflow (Err 256),  
 Program error (busy) (Err 2048)

### Action stop (Error number is not displayed [Operation: Impossible]):

Power supply voltage monitoring, RAM check error

### Instrument status:

When a self-diagnostic error occurs: All output OFF

Display: In an error is detected by the Self-diagnostic function, the PV display shows "Err," and the SV display shows the error code.

Output: Same as power OFF

## ■ Power

### Power supply voltage:

100 to 240 V AC type:

90 to 264 V AC [Including power supply voltage variation], 50/60 Hz,  
 (Rating 100 to 240 V AC)

Frequency variation: 50 Hz±10 %, 60 Hz±10 %

24 V AC type:

21.6 to 26.4 V AC [Including power supply voltage variation], 50/60 Hz,  
 (Rating 24 V AC)

Frequency variation: 50 Hz±10 %, 60 Hz±10 %

24 V DC type:

21.6 to 26.4 V DC [Including power supply voltage variation]  
 (Rating 24 V DC)

### Power consumption (at maximum load):

100 to 240 V AC type:

5.4 VA max. (at 100 V AC), 8.1 VA max. (at 240 V AC)

24 V AC type:

5.3 VA max. (at 24 V AC)

24 V DC type:

142 mA max. (at 24 V DC)

### Rush current:

12 A or less



---

**Mounting and Structure:** Mounting method: Panel-mounted  
Front panel material: PPE [Flame retardancy: UL94 V-1]  
Case material: PPE [Flame retardancy: UL94 V-1]  
Filter material: Acrylic

**Weight:** Approx. 150 g

■ **Standard**

**Safety standards:** UL: UL61010-1  
cUL: CAN/CSA-C22.2 No.61010-1

**CE marking:** LVD: EN61010-1  
OVERVOLTAGE CATEGORYII,  
POLLUTION DEGREE 2,  
Class II (Reinforced insulation)

EMC: EN61326-1

**RCM:** EN55011

**Panel sealing:** NEMA 4X (NEMA250), IP66 (IEC60529)  
[Front panel]

**MEMO**



# APPENDIX

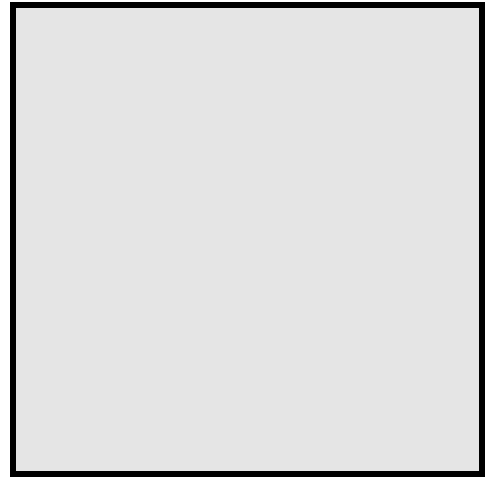

A. Removing the Internal Assembly.....	A-2
B. Replacing the Waterproof/Dustproof Rubber Packing.....	A-4
C. Current Transformer (CT) Dimensions.....	A-6
D. Memory Area Data List .....	A-7
E. Parameter List.....	A-8
F. Seal [for Unit and Direct key] (accessory attached).....	A-24

# A. Removing the Internal Assembly

Removing the internal assembly from the case is rarely required. Should you remove the internal assembly without disconnecting the external wiring, take the following steps:

## WARNING

- To prevent electric shock or instrument failure, only qualified personnel should be allowed to pull out the internal assembly.
- To prevent electric shock or instrument failure, always turn off the power before pulling out the internal assembly.
- To prevent injury or instrument failure, do not touch the internal printed wiring board.



**Apply pressure very carefully when removing internal assembly to avoid damage to the frame.**



To conform to **IEC61010-1** requirements for protection from electric shock, the internal assembly of this instrument can only be removed with an appropriate tool.

### ■ Procedures

1. Insert the screwdriver in the plug-in lock section as shown in the following figure, and then lightly push the screwdriver in the horizontal direction to release the plug-in lock released bar. The plug-in lock section is released.

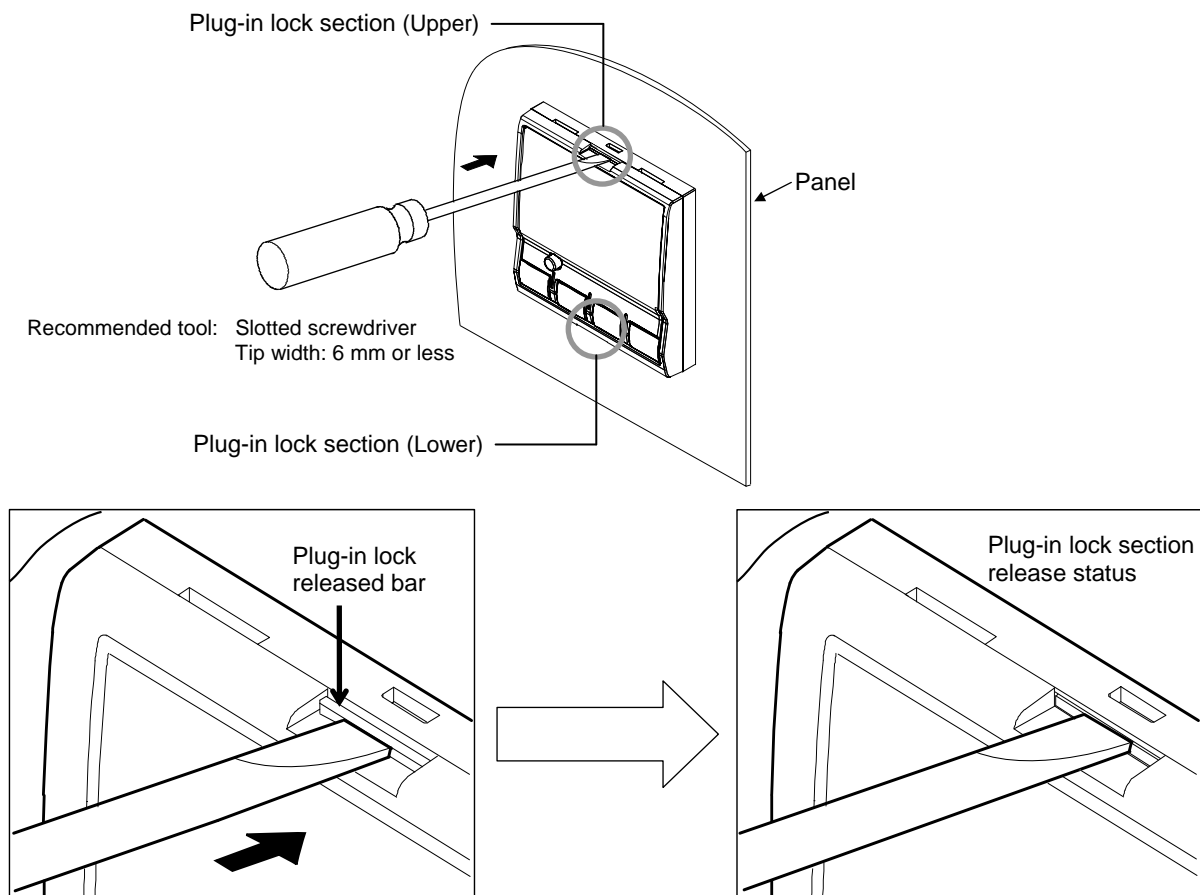

2. Insert the screwdriver in the case lock section as shown in the following figure, and then lightly turn the screwdriver to release the case lock section. The case lock section is released.

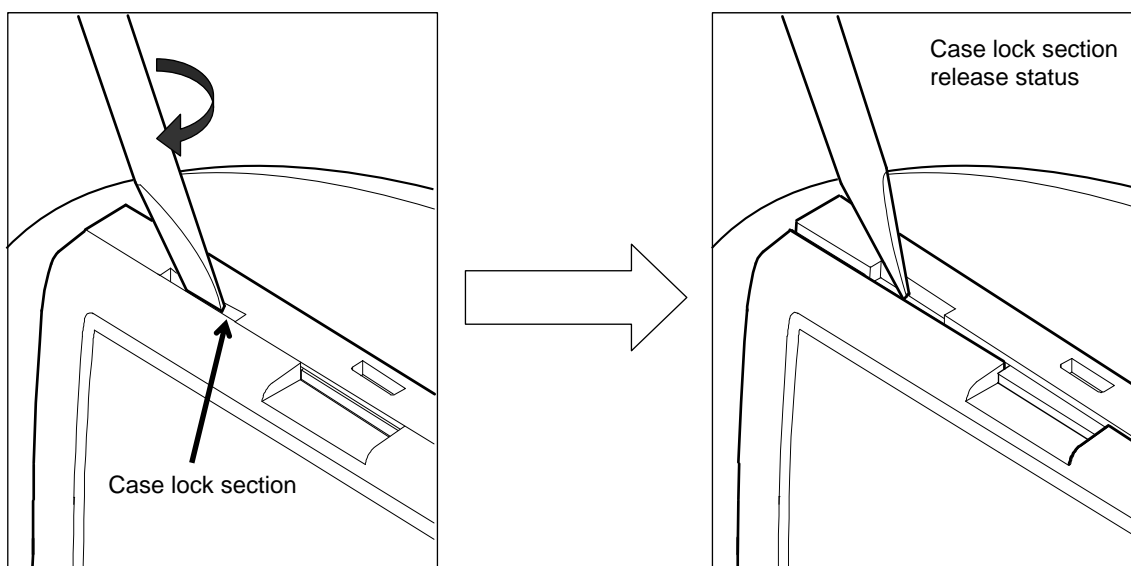
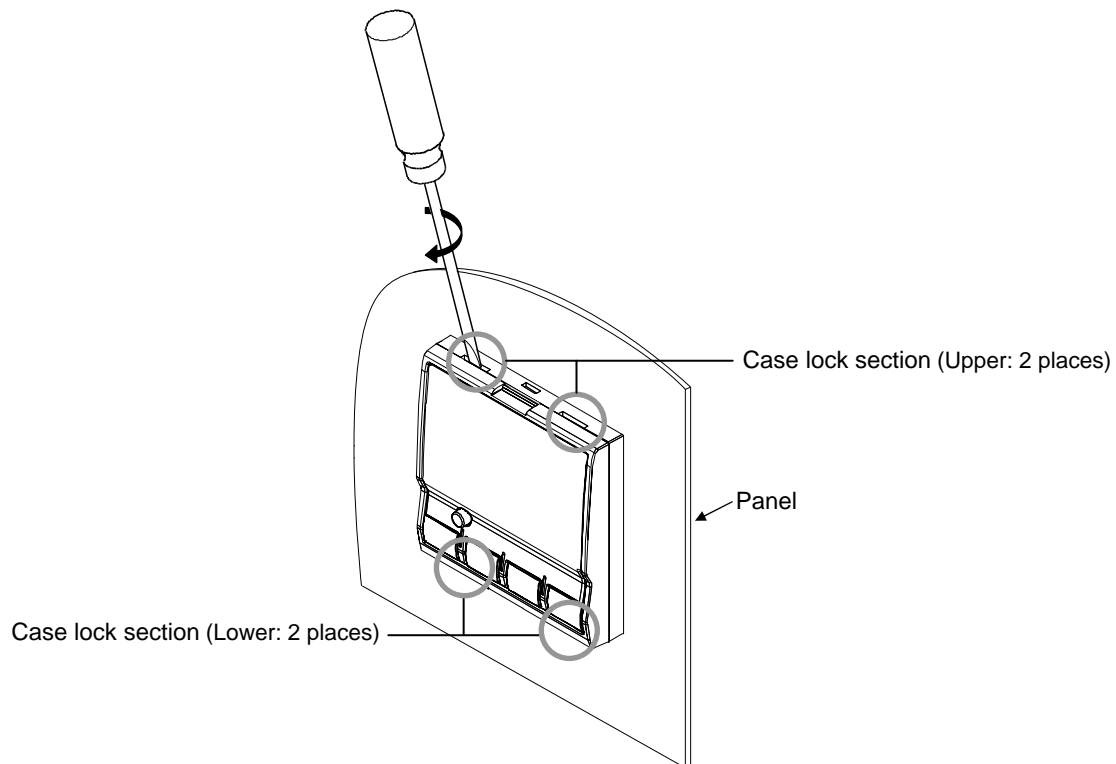

3. The other case lock section should be released the same way described in steps *1* and *2*.
4. Remove the internal assembly from the case.

## B. Replacing the Waterproof/Dustproof Rubber Packing

If the waterproof and dustproof rubber packing deteriorates, please contact RKC sales office or the agent. To replace the rubber packing, take the following steps:



### WARNING

- In order to prevent electric shock and instrument failure, always turn off the power supply before replacing the rubber packing.
- In order to prevent electric shock and instrument failure, always turn off the power supply before pulling out the internal chassis.
- In order to prevent injury or instrument failure, do not touch the internal printed circuit board.

### ■ Replacement of the case rubber packing

1. Turn the power OFF.
2. Remove the wiring.
3. Remove the mounting bracket, and then remove the instrument from the control panel.  
 Refer to **3.3 Procedures of Mounting and Removing (P. 3-4)**.
4. Remove the old rubber packing, and then replace the old rubber packing with a new one.

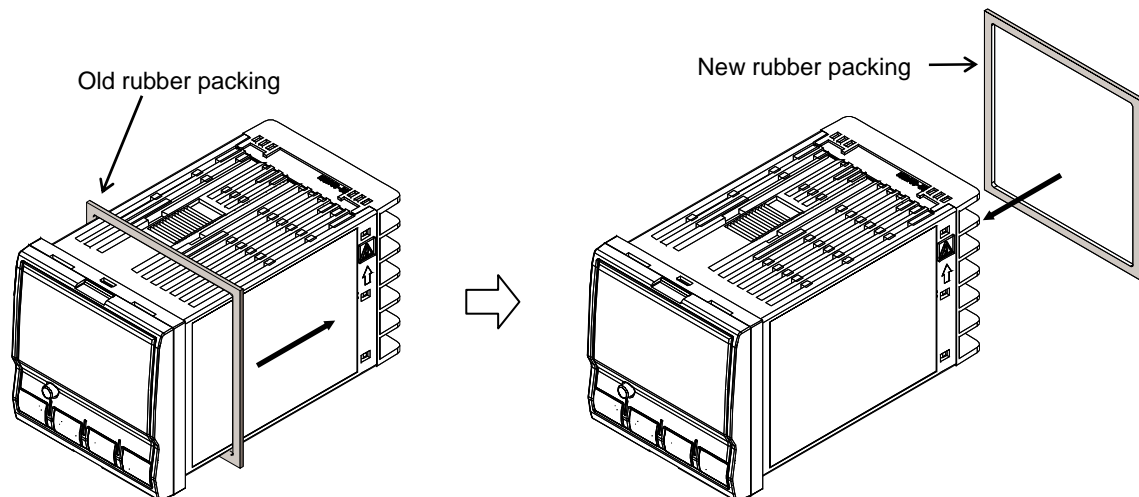

#### Parts list

<b>Parts code</b>	KRB100-39
<b>Ordering code</b>	00452425

## ■ Replacement of the board rubber packing

1. Turn the power OFF.
2. Remove the internal assembly from the case.
  - ☞ Refer to **APPENDIX A. Removing the Internal Assembly (P. A-2)**.
3. Remove the old rubber packing, and then replace the old rubber packing with a new one.

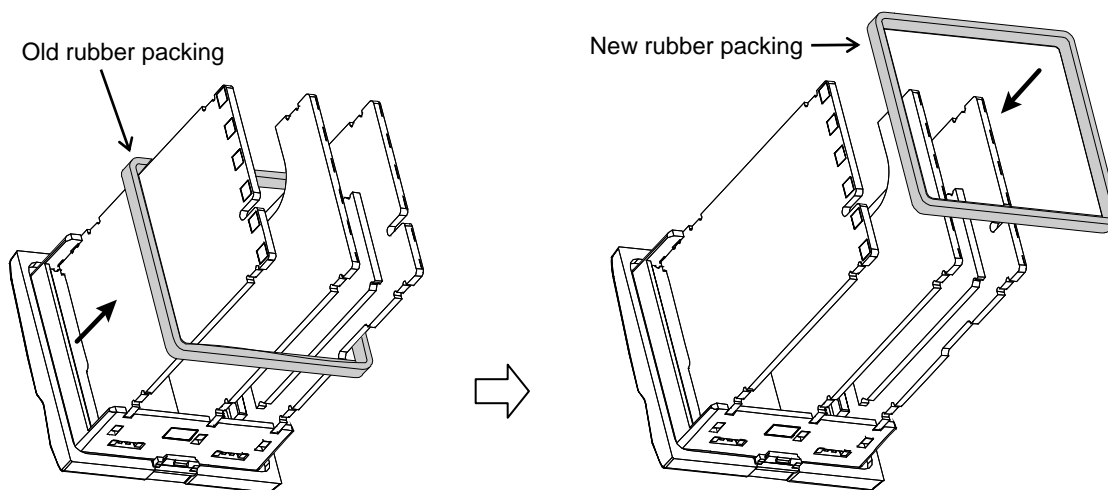

### Part list

<b>Parts code</b>	KRB100-35
<b>Ordering code</b>	00458663

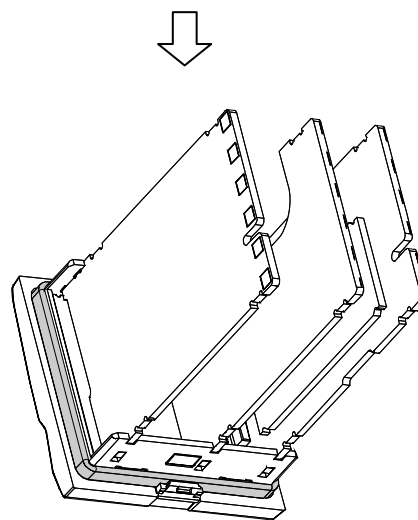

Rubber packing mounting status

4. Insert the internal assembly in the case.

# C. Current Transformer (CT) Dimensions

## ■ CTL-6-P-N (For 0 to 30 A)

(Unit: mm)

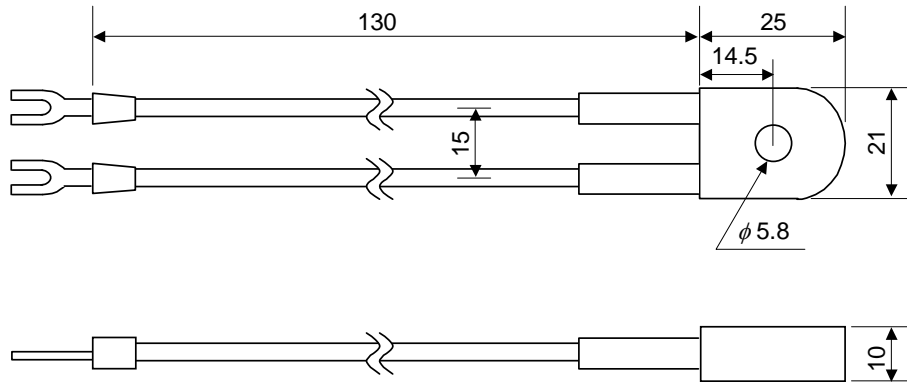

## ■ CTL-12-S56-10L-N (For 0 to 100 A)

(Unit: mm)

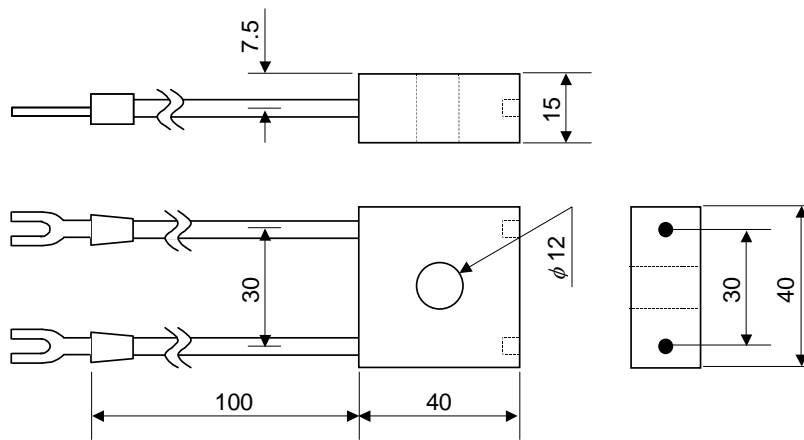

# D. Memory Area Data List

(Copy this sheet for its use.)

Sheet No.	Memory area No.	Date	Name
Display	Item	Set value	Memo
<i>SV</i>	Set value (SV)		
<i>EV1</i>	Event 1 set value (EV1)		
<i>EV2</i>	Event 2 set value (EV2)		
<i>EV3</i>	Event 3 set value (EV3)		
<i>EV4</i>	Event 4 set value (EV4)		
<i>LbA</i>	Control loop break alarm (LBA) time		
<i>Lbd</i>	LBA deadband		
<i>P</i>	Proportional band [heat-side]		
<i>I</i>	Integral time [heat-side]		
<i>d</i>	Derivative time [heat-side]		
<i>rPF</i>	Control response parameter		
<i>Pc</i>	Proportional band [cool-side]		
<i>Ic</i>	Integral time [cool-side]		
<i>dc</i>	Derivative time [cool-side]		
<i>db</i>	Overlap/Deadband		
<i>nr</i>	Manual reset		
<i>SVrU</i>	Setting change rate limiter (up)		
<i>SVrd</i>	Setting change rate limiter (down)		
<i>ASF</i>	Area soak time		
<i>LnLA</i>	Link area number		

Ramp/Soak control	1	2	3	4	5	6	7	8
<p>A1 to A3: Soak time B1 to B3: Setting change rate limiter</p>								
Link area number								
Area soak time								
Setting change rate limiter (up)								
Setting change rate limiter (down)								





Continued from the previous page.

Symbol	Name	Data range	Factory set value	User set value	Page
<i>PS<math>\bar{n}</math>'</i>	Manipulated output value at MV transfer <sup>1</sup>	PID control: Output limiter low [MV1] to Output limiter high [MV1] Heat/Cool PID control: -Output limiter high [MV2] to +Output limiter high [MV1] For overlap: -105.0 to +105.0 % * * Actual output value is limited by the output limiter function.	0.0		7-11
<i>ILr</i>	Interlock release <sup>2</sup>	on: Interlock oFF: Interlock release	oFF		7-13

<sup>1</sup> This screen is not displayed when set the MV transfer function to "0."

<sup>2</sup> Not displayed when Event 1, 2, 3 or 4 interlock function is not used.

## ■ Operation mode

Symbol	Name	Data range	Factory set value	User set value	Page
<i>ATU</i>	PID/AT transfer	on: Autotunig (AT) oFF: PID control	oFF		6-15 7-15
<i>STU</i>	Startup tuning (ST) <sup>1</sup>	on1: Execute once on2: Execute always oFF: ST unused	oFF		6-18 7-16
<i>CHR</i>	Automatic temperature rise learning <sup>2</sup>	on: Learning oFF: Unused	on		6-72 7-17
<i>A-M</i>	Auto/Manual transfer	AUTo: Auto mode MAN: Manual mode	AUTo		6-23 7-18
<i>r-L</i>	Remote/Local transfer <sup>3</sup>	LoC: Local mode rEM: Remote mode	LoC		6-29 7-19
<i>L-E</i>	Control area internal (LOC)/ External (EXT) transfer <sup>4</sup>	LoC: Local mode EXT: External mode	LoC		6-38 7-20
<i>r-S</i>	RUN/STOP transfer	rUN: RUN mode (Control start) SToP: STOP mode (Control stop)	rUn		6-11 7-21

<sup>1</sup> This screen is not displayed when the control action is Position proportioning PID control.

<sup>2</sup> This screen is not displayed when set the Automatic temperature rise group to "0."

<sup>3</sup> Displayed only when the Remote setting (RS) input is provided.

<sup>4</sup> Not displayed when Digital input (DI) assignment (Engineering mode) is somewhere between 6 and 12.

## ■ Parameter setting mode

Symbol	Name	Data range	Factory set value	User set value	Page
<i>EH1</i>	Event 1 set value (EV1) <sup>1,2</sup>	Deviation: –Input span to +Input span [Varies with the setting of the Decimal point position]  Process and set value: Input scale low to Input scale high [Varies with the setting of the Decimal point position]  Manipulated output value (MV1 or MV2): –5.0 to +105.0 %	50		7-24
<i>EH2</i>	Event 2 set value (EV2) <sup>1,2</sup>		50		7-24
<i>EH3</i>	Event 3 set value (EV3) <sup>1,2</sup>		50		7-24
<i>EH4</i>	Event 4 set value (EV4) <sup>1,2,3</sup>		50		7-24
<i>LbA</i>	Control loop break alarm (LBA) time <sup>1,4</sup>	1 to 7200 seconds oFF: Unused	480		7-25
<i>LbD</i>	LBA deadband <sup>1,4</sup>	0 to Input span [Varies with the setting of the Decimal point position]	0		7-26
<i>P</i>	Proportional band <sup>1</sup> [heat-side]	TC/RTD inputs: 0 (0.0, 0.00) to Input span (Unit: °C [°F]) [Varies with the setting of the Decimal point position]  Voltage (V)/Current (I) inputs: 0.0 to 1000.0 % of Input span 0 (0.0, 0.00): ON/OFF action	TC/RTD: 30 V/I: 30.0		7-27
<i>I</i>	Integral time [heat-side] <sup>1</sup>	PID control or Heat/Cool PID control: 1 to 3600 seconds or 0.1 to 1999.9 seconds oFF: PD action [both heat-side and cool-side]  Position proportioning PID control: 1 to 3600 seconds or 0.1 to 1999.9 seconds [Varies with the setting of the Integral/ Derivative decimal point position]	240		7-28
<i>D</i>	Derivative time [heat-side] <sup>1</sup>	1 to 3600 seconds or 0.1 to 1999.9 seconds oFF: PI action [Varies with the setting of the Integral/ Derivative decimal point position]	60		7-28
<i>rPF</i>	Control response parameter <sup>1</sup>	0: Slow 1: Medium 2: Fast  When the P or PD action is selected, this setting becomes invalid.	PID control, Position proportioning PID control: 0 Heat/Cool PID control: 2		7-29
<i>Pc</i>	Proportional band <sup>1,5</sup> [cool-side]	TC/RTD inputs: 1 (0.1, 0.01) to Input span (Unit: °C [°F]) [Varies with the setting of the Decimal point position]  Voltage (V)/Current (I) inputs: 0.1 to 1000.0 % of Input span	TC/RTD: 30 V/I: 30.0		7-30

<sup>1</sup> Parameters related to Multi-memory area function

<sup>2</sup> Not displayed when Event function is not used.

<sup>3</sup> EV4 is not displayed when the Event 4 is used as an LBA.

<sup>4</sup> This screen is displayed when the Event 4 is used as an LBA.

<sup>5</sup> This screen is displayed when the control action is Heat/Cool PID control.

Continued on the next page.

Continued from the previous page.

Symbol	Name	Data range	Factory set value	User set value	Page
<i>ic</i>	Integral time <sup>1, 2</sup> [cool-side]	1 to 3600 seconds or 0.1 to 1999.9 seconds oFF: PD action [Varies with the setting of the Integral/ Derivative decimal point position]	240		7-30
<i>dc</i>	Derivative time <sup>1, 2</sup> [cool-side]	1 to 3600 seconds or 0.1 to 1999.9 seconds oFF: PI action [Varies with the setting of the Integral/ Derivative decimal point position]	60		7-31
<i>db</i>	Overlap/Deadband <sup>1, 2</sup>	TC/RTD inputs: –Input span to +Input span (Unit:°C [°F]) [Varies with the setting of the Decimal point position] Voltage (V)/Current (I) inputs: –100.0 to +100.0 % of Input span Minus (–) setting results in Overlap. However, the overlapping range is within the proportional range.	0		7-32
<i>nr</i>	Manual reset <sup>1, 3</sup>	–100.0 to +100.0 %	0.0		7-33
<i>SURU</i>	Setting change rate limiter (up) <sup>1</sup>	1 (0.1, 0.01) to Input span/unit time oFF: Unused	oFF		7-34
<i>SURd</i>	Setting change rate limiter (down) <sup>1</sup>	[Varies with the setting of the Decimal point position]	oFF		7-34
<i>ASf</i>	Area soak time <sup>1, 4</sup>	0 minutes 00 seconds to 199 minutes 59 seconds or 0 hours 00 minutes to 99 hours 59 minutes	0:00		7-35
<i>LnRA</i>	Link area number <sup>1, 4</sup>	1 to 8 oFF: No link	oFF		7-36

<sup>1</sup> Parameters related to Multi-memory area function<sup>2</sup> This screen is displayed when the control action is Heat/Cool PID control.<sup>3</sup> The screen is displayed when the Integral time [heat-side] or Integral time [cool-side] is set to “oFF.”<sup>4</sup> Not displayed when Digital input (DI) assignment (Engineering mode) is somewhere between 6 and 12.

## ■ Setup setting mode

Symbol	Name	Data range	Factory set value	User set value	Page
<i>HbA1</i>	Heater break alarm 1 (HBA1) set value <sup>a, b</sup>	When CT is CTL-6-P-N: 0.1 to 30.0 A oFF: Not used When CT is CTL-12-S56-10L-N: 0.1 to 100.0 A oFF: Not used	oFF		7-38
<i>HbL1</i>	Heater break determination point 1 <sup>a, b, c</sup>	0.1 to 100.0 % of HBA1 set value oFF: Heater break determination is invalid	30.0		7-41
<i>HbH1</i>	Heater melting determination point 1 <sup>a, b, c</sup>	0.1 to 100.0 % of HBA1 set value oFF: Heater melting determination is invalid	30.0		7-42
<i>HbA2</i>	Heater break alarm 2 (HBA2) set value <sup>d, e</sup>	When CT is CTL-6-P-N: 0.1 to 30.0 A oFF: Not used When CT is CTL-12-S56-10L-N: 0.1 to 100.0 A oFF: Not used	oFF		7-38
<i>HbL2</i>	Heater break determination point 2 <sup>a, b, c</sup>	0.1 to 100.0 % of HBA2 set value oFF: Heater break determination is invalid	30.0		7-41
<i>HbH2</i>	Heater melting determination point 2 <sup>a, b, c</sup>	0.1 to 100.0 % of HBA2 set value oFF: Heater melting determination is invalid	30.0		7-42
<i>Pb</i>	PV bias	-Input span to +Input span [Varies with the setting of the Decimal point position]	0		7-43
<i>dF</i>	PV digital filter	0.1 to 100.0 seconds oFF: Unused	oFF		7-43
<i>P<sub>r</sub></i>	PV ratio	0.500 to 1.500	1.000		7-43
<i>PLC</i>	PV low input cut-off	0.00 to 25.00 % of input span	0.00		7-44
<i>r<sub>b</sub></i>	RS bias <sup>g</sup>	-Input span to +Input span [Varies with the setting of the Decimal point position]	0		7-45
<i>dF<sub>2</sub></i>	RS digital filter <sup>g</sup>	0.1 to 100.0 seconds oFF: Unused	oFF		7-45
<i>r<sub>r</sub></i>	RS ratio <sup>g</sup>	0.001 to 9.999	1.000		7-45
<i>r</i>	Proportional cycle time [heat-side]	0.1 to 100.0 seconds	20.0 <sup>h</sup>		7-46
<i>t</i>	Proportional cycle time [cool-side]	0.1 to 100.0 seconds	20.0 <sup>h</sup>		7-46
<i>Add1</i>	Device address 1 <sup>i</sup>	0 to 99	0		7-47

<sup>a</sup> Displayed when the CT1 is provided.

<sup>b</sup> This screen is not displayed when set the CT1 assignment to "0: None."

<sup>c</sup> Displayed when the HBA1 type is type B.

<sup>d</sup> Displayed when the CT2 is provided.

<sup>e</sup> This screen is not displayed when set the CT2 assignment to "0: None."

<sup>f</sup> Displayed when the HBA2 type is type B.

<sup>g</sup> Displayed when the Remote setting (RS) is provided.

<sup>h</sup> Factory set value varies depending on the instrument specification.

<sup>i</sup> Displayed only when the Communication 1 is provided.

Continued on the next page.

Continued from the previous page.

Symbol	Name	Data range	Factory set value	User set value	Page																																																							
<i>bPS1</i>	Communication speed 1 <sup>a, b</sup>	2.4: 2400 bps 4.8: 4800 bps 9.6: 9600 bps 19.2: 19200 bps 38.4: 38400 bps	19.2		7-48																																																							
<i>b1F1</i>	Data bit configuration 1 <sup>a, b</sup>	<table border="1"> <thead> <tr> <th rowspan="2"></th> <th colspan="3">Bit configuration</th> </tr> <tr> <th>Data</th> <th>Stop</th> <th>Parity</th> </tr> </thead> <tbody> <tr> <td>8n1</td> <td>8</td> <td>1</td> <td>Without</td> </tr> <tr> <td>8n2</td> <td>8</td> <td>2</td> <td>Without</td> </tr> <tr> <td>8E1</td> <td>8</td> <td>1</td> <td>Even</td> </tr> <tr> <td>8E2</td> <td>8</td> <td>2</td> <td>Even</td> </tr> <tr> <td>8o1</td> <td>8</td> <td>1</td> <td>Odd</td> </tr> <tr> <td>8o2</td> <td>8</td> <td>2</td> <td>Odd</td> </tr> <tr> <td>7n1 *</td> <td>7</td> <td>1</td> <td>Without</td> </tr> <tr> <td>7n2 *</td> <td>7</td> <td>2</td> <td>Without</td> </tr> <tr> <td>7E1 *</td> <td>7</td> <td>1</td> <td>Even</td> </tr> <tr> <td>7E2 *</td> <td>7</td> <td>2</td> <td>Even</td> </tr> <tr> <td>7o1 *</td> <td>7</td> <td>1</td> <td>Odd</td> </tr> <tr> <td>7o2 *</td> <td>7</td> <td>2</td> <td>Odd</td> </tr> </tbody> </table> <p>* When the Modbus communication protocol selected, this setting becomes invalid.</p>		Bit configuration			Data	Stop	Parity	8n1	8	1	Without	8n2	8	2	Without	8E1	8	1	Even	8E2	8	2	Even	8o1	8	1	Odd	8o2	8	2	Odd	7n1 *	7	1	Without	7n2 *	7	2	Without	7E1 *	7	1	Even	7E2 *	7	2	Even	7o1 *	7	1	Odd	7o2 *	7	2	Odd	8n1		7-49
	Bit configuration																																																											
	Data	Stop	Parity																																																									
8n1	8	1	Without																																																									
8n2	8	2	Without																																																									
8E1	8	1	Even																																																									
8E2	8	2	Even																																																									
8o1	8	1	Odd																																																									
8o2	8	2	Odd																																																									
7n1 *	7	1	Without																																																									
7n2 *	7	2	Without																																																									
7E1 *	7	1	Even																																																									
7E2 *	7	2	Even																																																									
7o1 *	7	1	Odd																																																									
7o2 *	7	2	Odd																																																									
<i>Int1</i>	Interval time 1 <sup>a, b</sup>	0 to 250 ms	10		7-50																																																							
<i>Addr2</i>	Device address 2 <sup>c</sup>	0 to 99	0		7-47																																																							
<i>bPS2</i>	Communication speed 2 <sup>b, c</sup>	2.4: 2400 bps 4.8: 4800 bps 9.6: 9600 bps 19.2: 19200 bps 38.4: 38400 bps	19.2		7-48																																																							
<i>b1F2</i>	Data bit configuration 2 <sup>b, c</sup>	Same as the Data bit configuration 1	8n1		7-49																																																							
<i>Int2</i>	Interval time 2 <sup>b, c</sup>	0 to 250 ms	10		7-50																																																							
<i>LCK</i>	Set lock level	0: Unlock 1: Lock Set to "0" or "1" for each digit. 	0000		7-51																																																							

<sup>a</sup> Displayed only when the Communication 1 is provided.

<sup>b</sup> This screen is not displayed when the Intercontroller communication function is selected.

<sup>c</sup> Displayed only when the Communication 2 is provided.

## ■ Engineering mode

Parameters in Engineering mode are settable only when the controller is in STOP mode. However, it is possible to check only the data even in RUN mode.

In addition, there are invalid parameters when no optional function is specified.

Symbol	Name	Data range	Factory set value	User set value	Page
<i>F 10.</i>	Function block 10	This is first parameter symbol of Function block 10.			
<i>SPCH</i>	STOP display	0: "SToP" is displayed on the PV display. 1: "SToP" is displayed on the SV display.	1		7-65
<i>dE</i>	Bar graph display	0: No display                    4: Deviation value 1: MV                            5: CT1 input value 2: PV                            6: CT2 input value 3: SV monitor	1		7-66
<i>dEUR</i>	Bar graph display resolution	1 to 100 digit/dot	100		7-68
<i>dSoP</i>	PV flashing display at input error	0: Flashing display 1: Non-flashing display	0		7-69
<i>F 11.</i>	Function block 11	This is first parameter symbol of Function block 11.			
<i>F n I</i>	Direct key selection	0: Unused 1: Direct key	1		7-70
<i>F n</i>	Direct key type	1: Auto/Manual transfer 2: Monitor 3: Memory area transfer 4: Remote/Local transfer 5: RUN/STOP transfer	1		7-70
<i>F 2 1.</i>	Function block 21	This is first parameter symbol of Function block 21.			
<i>I nP</i>	Input type	0: TC input K 1: TC input J 2: TC input R 3: TC input S 4: TC input B 5: TC input E 6: TC input N 7: TC input T 8: TC input W5Re/W26Re 9: TC input PLII 10: TC input U 11: TC input L 12: RTD input Pt100 13: RTD input JPt100 14: Current input 0 to 20 mA DC 15: Current input 4 to 20 mA DC 16: Voltage (high) input 0 to 10 V DC 17: Voltage (high) input 0 to 5 V DC 18: Voltage (high) input 1 to 5 V DC 19: Voltage (low) input 0 to 1 V DC 20: Voltage (low) input 0 to 100 mV DC 21: Voltage (low) input 0 to 10 mV DC 24: Voltage (high) input ±1 V DC 25: Voltage (low) input ±100 mV DC 26: Voltage (low) input ±10 mV DC	0 <sup>a</sup>		7-71
<i>Uni F</i>	Display unit	0: °C 1: °F Use to select the temperature unit for Thermocouple (TC) and RTD inputs.	0		7-73

<sup>a</sup> Factory set value varies depending on the instrument specification.

Continued on the next page.

Continued from the previous page.

Symbol	Name	Data range	Factory set value	User set value	Page
<i>PCDP</i>	Decimal point position	0: No decimal place 1: One decimal place 2: Two decimal places 3: Three decimal places 4: Four decimal places TC input: K, J, E: Only 0 or 1 can be set. T, U, L: Only 1 can be set. Other than the above: Only 0 can be set. RTD input: From 0 to 2 can be set. V/I inputs: From 0 to 4 can be set.	0 <sup>a</sup>		7-73
<i>PCSH</i>	Input scale high	TC/RTD inputs: Input scale low to Maximum value of the selected input range Voltage (V)/Current (I) inputs: -19999 to +19999 [Varies with the setting of the Decimal point position]	Maximum value of the selected input range <sup>a</sup>		7-74
<i>PCSL</i>	Input scale low	TC/RTD inputs: Minimum value of the selected input range to Input scale high Voltage (V)/Current (I) inputs: -19999 to +19999 [Varies with the setting of the Decimal point position]	Minimum value of the selected input range <sup>a</sup>		7-74
<i>POH</i>	Input error determination point (high)	Input scale low – (5 % of input span) to Input scale high + (5 % of input span)	Input scale high + (5 % of input span) <sup>a</sup>		7-76
<i>PUH</i>	Input error determination point (low)	[Varies with the setting of the Decimal point position]	Input scale low – (5 % of input span) <sup>a</sup>		7-76
<i>BO5</i>	Burnout direction	0: Upscale 1: Downscale Valid only when the TC input and Voltage (low) input are selected.	0		7-77
<i>SQR</i>	Square root extraction	0: Unused 1: Used	0		7-77
<i>PF-9</i>	Power supply frequency	0: 50 Hz 1: 60 Hz	0		7-78
<i>S-9P</i>	Sampling cycle	0: 50 ms 1: 100 ms 2: 250 ms	1		7-78
<i>F22.</i>	Function block 22	This is first parameter symbol of Function block 22.			
<i>rl nP</i>	Remote setting input type	14: 0 to 20 mA DC 15: 4 to 20 mA DC 16: 0 to 10 V DC 17: 0 to 5 V DC 18: 1 to 5 V DC 19: 0 to 1 V DC 20: 0 to 100 mV DC 21: 0 to 10 mV DC	15 <sup>a</sup>		7-79

<sup>a</sup> Factory set value varies depending on the instrument specification.

Continued on the next page.

Continued from the previous page.

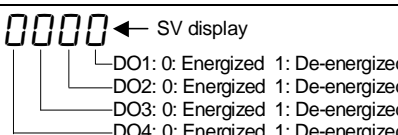
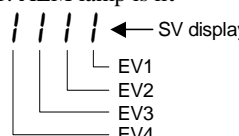
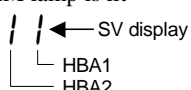
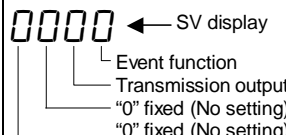
Symbol	Name	Data range	Factory set value	User set value	Page
<i>F23.</i>	Function block 23	This is first parameter symbol of Function block 23.			
<i>di SL</i>	Digital input (DI) assignment	1 to 26 Refer to <b>Table 1 (P. A-22)</b> .	1		7-80
<i>F30.</i>	Function block 30	This is first parameter symbol of Function block 30.			
<i>LoGC</i>	Output assignment	1 to 15 Refer to <b>Table 2 (P. A-23)</b> .	2		7-82
<i>off1</i>	Timer 1	0.0 to 600.0 seconds	0.0		7-83
<i>off2</i>	Timer 2		0.0		7-83
<i>off3</i>	Timer 3		0.0		7-83
<i>off4</i>	Timer 4		0.0		7-83
<i>EYC</i>	Energized/De-energized		0000		7-83
<i>ALC1</i>	Alarm (ALM) lamp lighting condition 1 <sup>a</sup>	0: ALM lamp is not lit 1: ALM lamp is lit 	1111		7-84
<i>ALC2</i>	Alarm (ALM) lamp lighting condition 2 <sup>a</sup>	0: ALM lamp is not lit 1: ALM lamp is lit 	0011		7-84
<i>SS</i>	Output status at STOP mode	0: OFF 1: Action continued 	0000		7-85
<i>F33.</i>	Function block 33	This is first parameter symbol of Function block 33.			
<i>Ro</i>	Transmission output type	0: None 1: PV 2: Set value (SV) monitor 3: Deviation value 4: MV1 [heat-side] 5: MV2 [cool-side] 6: Set value (SV) 7: Remote setting (RS) input value	1		7-86
<i>AHS</i>	Transmission output scale high	When the PV, SV, SV monitor and RS: Input scale low to Input scale high [Varies with the setting of the Decimal point position]	Input scale high		7-87
<i>ALS</i>	Transmission output scale low	When the MV1 and MV2: -5.0 to +105.0 % When the deviation value: -Input span to +Input span	Input scale low		7-87

<sup>a</sup> The ALM lamp is lit through the *OR* operation of EV1, EV2, EV3, EV4, HBA1 and HBA2 each of which is set to “1: ALM lamp is lit.”

Continued on the next page.

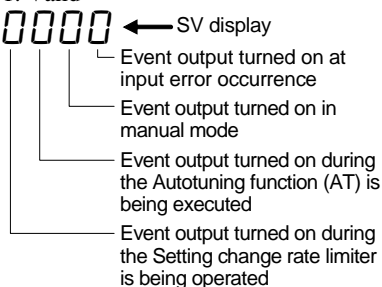

Continued from the previous page.

Symbol	Name	Data range	Factory set value	User set value	Page
<i>F41.</i>	Function block 41	This is first parameter symbol of Function block 41.			
<i>ES1</i>	Event 1 type	0: None 1: Deviation high <sup>1</sup> 2: Deviation low <sup>1</sup> 3: Deviation high/low <sup>1</sup> 4: Band <sup>1</sup> 5: Process high <sup>1</sup> 6: Process low <sup>1</sup> 7: SV high 8: SV low 9: Unused 10: MV1 high [heat-side] <sup>1,2</sup> 11: MV1 low [heat-side] <sup>1,2</sup> 12: MV2 high [cool-side] <sup>1</sup> 13: MV2 low [cool-side] <sup>1</sup> <sup>1</sup> Event hold action is available. <sup>2</sup> Feedback resistance (FBR) input value is displayed when the control motor with Feedback resistance (FBR) is used.	0 <sup>a</sup>		7-88
<i>EHo1</i>	Event 1 hold action	0: OFF                    2: Re-hold action ON 1: Hold action ON	0 <sup>a</sup>		7-90
<i>EIL1</i>	Event 1 interlock	0: Unused 1: Used	0		7-92
<i>EH1</i>	Event 1 differential gap	Deviation, process or set value: 0 to Input span [Varies with the setting of the Decimal point position] MV: 0.0 to 110.0 %	2 <sup>a</sup>		7-93
<i>EHF1</i>	Event 1 delay timer	0.0 to 600.0 seconds	0.0		7-94
<i>EEo1</i>	Force ON of Event 1 action	0: Invalid 1: Valid 	0000		7-96
<i>F42.</i>	Function block 42	This is first parameter symbol of Function block 42.			
<i>ES2</i>	Event 2 type	Same as Event 1 type			7-97
<i>EHo2</i>	Event 2 hold action	Same as Event 1 hold action			7-98
<i>EIL2</i>	Event 2 interlock	Same as Event 1 interlock			7-99
<i>EH2</i>	Event 2 differential gap	Same as Event 1 differential gap			7-99
<i>EHF2</i>	Event 2 delay timer	Same as Event 1 delay timer			7-100
<i>EEo2</i>	Force ON of Event 2 action	Same as Force ON of Event 1 action			7-100
<i>F43.</i>	Function block 43	This is first parameter symbol of Function block 43.			
<i>ES3</i>	Event 3 type	Same as Event 1 type			7-101
<i>EHo3</i>	Event 3 hold action	Same as Event 1 hold action			7-102

<sup>a</sup> Factory set value varies depending on the instrument specification.

Continued on the next page.

Continued from the previous page.

Symbol	Name	Data range	Factory set value	User set value	Page
<i>E1L3</i>	Event 3 interlock	Same as Event 1 interlock			7-103
<i>EH3</i>	Event 3 differential gap	Same as Event 1 differential gap			7-103
<i>EDF3</i>	Event 3 delay timer	Same as Event 1 delay timer			7-104
<i>EEo3</i>	Force ON of Event 3 action	Same as Force ON of Event 1 action			7-104
<i>F44.</i>	Function block 44	This is first parameter symbol of Function block 44.			
<i>E54</i>	Event 4 type	9: Control loop break alarm (LBA) The other data is the same as an Event 1 type.			7-105
<i>EHo4</i>	Event 4 hold action <sup>a</sup>	Same as Event 1 hold action			7-107
<i>E1L4</i>	Event 4 interlock	Same as Event 1 interlock			7-108
<i>EH4</i>	Event 4 differential gap <sup>a</sup>	Same as Event 1 differential gap The invalidity in case of the LBA.			7-109
<i>EDF4</i>	Event 4 delay timer	Same as Event 1 delay timer			7-110
<i>EEo4</i>	Force ON of Event 4 action <sup>a</sup>	Same as Force ON of Event 1 action			7-111
<i>F45.</i>	Function block 45	This is first parameter symbol of Function block 45.			
<i>CFr1</i>	CT1 ratio	0 to 9999 CT type: CTL-6-P-N CTL-12-S56-10L-N	800 <sup>b</sup>		7-112
<i>CFR1</i>	CT1 assignment	0: None      2: OUT2 1: OUT1      3 to 4: Do not set this one	1		7-113
<i>HbS1</i>	Heater break alarm 1 (HBA1) type	0: Heater break alarm 1 (HBA1) type A 1: Heater break alarm 1 (HBA1) type B	0 <sup>b</sup>		7-113
<i>HbC1</i>	Number of heater break alarm 1 (HBA1) delay times	0 to 255	5		7-115
<i>F46.</i>	Function block 46.	This is first parameter symbol of Function block 46.			
<i>CFr2</i>	CT2 ratio	0 to 9999 CT type: CTL-6-P-N CTL-12-S56-10L-N	800 <sup>b</sup>		7-116
<i>CFR2</i>	CT2 assignment	0: None      2: OUT2 1: OUT1      3 to 4: Do not set this one	0		7-117
<i>HbS2</i>	Heater break alarm 2 (HBA2) type	0: Heater break alarm 2 (HBA2) type A 1: Heater break alarm 2 (HBA2) type B	0		7-118
<i>HbC2</i>	Number of heater break alarm 2 (HBA2) delay times	0 to 255	5		7-118
<i>F50.</i>	Function block 50	This is first parameter symbol of Function block 50.			
<i>Pd</i>	Hot/Cold start	0: Hot start 1      2: Cold start 1: Hot start 2      3: Stop start	0		7-119
<i>PdR</i>	Start determination point	0 to Input span (The unit is the same as input value.) (0: Action depending on the Hot/Cold start selection) [Varies with the setting of the Decimal point position]	3 % of input span		7-120
<i>CRn</i>	External input type	0: Remote setting (RS) input 1: Intercontroller communication cascade control 2: Intercontroller communication ratio setting	0		7-121
<i>nCH</i>	Master channel selection	0 to 31	0		7-122

<sup>a</sup> When the Control loop break alarm (LBA) is selected, the setting becomes invalid.<sup>b</sup> Factory set value varies depending on the instrument specification.

Continued on the next page.

Continued from the previous page.

Symbol	Name	Data range	Factory set value	User set value	Page
<i>r r L</i>	SV tracking	0: Unused      1: Used	1		7-123
<i>r n B F S</i>	MV transfer function [Action taken when changed to Manual mode from Auto mode]	0: MV1 or MV2 in Auto mode is used. 1: When selected by Digital input (DI): MV1 or MV2 in previous Manual mode is used. When selected by Front key: MV1 or MV2 in Auto mode is used. 2: MV1 or MV2 in previous Manual mode is used.	0		7-124
<i>P V F S</i>	PV transfer function	0: Unused      1: Used	0		7-124
<i>F S 1.</i>	Function block 51	This is first parameter symbol of Function block 51.			
<i>a S</i>	Control action	0: Brilliant II PID control (direct action) 1: Brilliant II PID control (reverse action) 2: Brilliant II Heat/Cool PID control [water cooling] 3: Brilliant II Heat/Cool PID control [air cooling] 4: Brilliant II Heat/Cool PID control [Cooling gain linear type] 5: Position proportioning PID control (reverse action) 6: Position proportioning PID control (direct action)	1 <sup>a</sup>		7-125
<i>I d d P</i>	Integral/derivative time decimal point position	0: 1 second setting (No decimal place) 1: 0.1 seconds setting (One decimal place)	0		7-129
<i>d G R</i>	Derivative gain	0.1 to 10.0	6.0		7-129
<i>a H H</i>	ON/OFF action differential gap (upper)	TC/RTD inputs: 0.0 to Input span (Unit: °C [°F]) [Varies with the setting of the Decimal point position]	1 <sup>a</sup>		7-130
<i>a H L</i>	ON/OFF action differential gap (lower)	Voltage (V)/Current (I) inputs: 0.0 to 100.0 % of input span	1 <sup>a</sup>		7-130
<i>A o b E</i>	Action (high) at input error	0: Normal control 1: Manipulated output value at input error	0		7-131
<i>A U n E</i>	Action (low) at input error		0		7-131
<i>P S n</i>	Manipulated output value at input error	-105.0 to +105.0 %	0.0		7-132
<i>r n B 1</i>	Manipulated output value (MV1) at STOP mode	-5.0 to +105.0 %	-5.0		7-132
<i>r n B 2</i>	Manipulated output value (MV2) at STOP mode		-5.0		7-132
<i>a r U</i>	Output change rate limiter (up) [MV1]	0.0 to 100.0 %/seconds of Manipulated output	0.0		7-133
<i>a r d</i>	Output change rate limiter (down) [MV1]	(0.0: OFF)	0.0		7-133
<i>a L H</i>	Output limiter high (MV1)	Output limiter low (MV1) to 105.0 %	105.0		7-135
<i>a L L</i>	Output limiter low (MV1)	-5.0 % to Output limiter high (MV1)	-5.0		7-135
<i>a r U 2</i>	Output change rate limiter (up) [MV2]	Same as Output change rate limiter (up) [MV1]	0.0		7-133
<i>a r d 2</i>	Output change rate limiter (down) [MV2]	Same as Output change rate limiter (down) [MV1]	0.0		7-133
<i>a L H 2</i>	Output limiter high (MV2)	Output limiter low (MV2) to 105.0 %	105.0		7-135

<sup>a</sup> Factory set value varies depending on the instrument specification.

Continued on the next page.

Continued from the previous page.

Symbol	Name	Data range	Factory set value	User set value	Page
<i>oLL2</i>	Output limiter low (MV2)	-5.0 % to Output limiter high (MV2)	-5.0		7-135
<i>dFP</i>	Derivative action	0: Measured value derivative 1: Deviation derivative	0		7-136
<i>US</i>	Undershoot suppression factor	0.000 to 1.000	1.000 <sup>a</sup>		7-137
<i>dbPA</i>	Overlap/Deadband reference point	0.0 to 1.0	0		7-138
<i>FS2.</i>	Function block 52	This is first parameter symbol of Function block 52.			
<i>ATb</i>	AT bias	-Input span to +Input span [Varies with the setting of the Decimal point position]	0		7-140
<i>ATC</i>	AT cycles	0: 1.5 cycles      2: 2.5 cycles 1: 2.0 cycles      3: 3.0 cycles	1		7-141
<i>ATG</i>	AT differential gap time	0.0 to 50.0 seconds	10.0		7-142
<i>ATon</i>	Output value with AT turned on	Output value with AT turned off to 105.0 %	105.0		7-143
<i>ATof</i>	Output value with AT turned off	-105.0 % to Output value with AT turned on	-105.0		7-143
<i>PLH</i>	Proportional band limiter (high) [heat-side]	TC/RTD inputs: 0 (0.0, 0.00) to Input span (Unit: °C [°F]) [Varies with the setting of the Decimal point position] Voltage (V)/Current (I) inputs: 0.0 to 1000.0 % of input span	Input span <sup>a</sup>		7-144
<i>PLL</i>	Proportional band limiter (low) [heat-side]		0 <sup>a</sup>		7-144
<i>ILH</i>	Integral time limiter (high) [heat-side]	0 to 3600 seconds or 0.0 to 1999.9 seconds [Varies with the setting of the Integral/ Derivative time decimal point position]	3600		7-145
<i>ILL</i>	Integral time limiter (low) [heat-side]		0		7-145
<i>dLH</i>	Derivative time limiter (high) [heat-side]		3600		7-146
<i>dLL</i>	Derivative time limiter (low) [heat-side]		0		7-146
<i>PcLH</i>	Proportional band limiter (high) [cool-side]	TC/RTD inputs: 1 (0.1, 0.01) to input span (Unit: °C [°F]) [Varies with the setting of the Decimal point position] Voltage (V)/Current (I) inputs: 0.1 to 1000.0 % of input span	Input span <sup>a</sup>		7-147
<i>PcLL</i>	Proportional band limiter (low) [cool-side]		1 <sup>a</sup>		7-147
<i>IcLH</i>	Integral time limiter (high) [cool-side]	Same as Integral time limiter (high) [heat-side]	3600		7-148
<i>IcLL</i>	Integral time limiter (low) [cool-side]	Same as Integral time limiter (low) [heat-side]	0		7-148
<i>dcLH</i>	Derivative time limiter (high) [cool-side]	Same as Derivative time limiter (high) [heat-side]	3600		7-149
<i>dcLL</i>	Derivative time limiter (low) [cool-side]	Same as Derivative time limiter (low) [heat-side]	0		7-149
<i>PAJ</i>	Proportional band adjusting factor [heat-side]	0.01 to 10.00 times	1.00		7-150
<i>I AJ</i>	Integral time adjusting factor [heat-side]		1.00		7-150
<i>dAJ</i>	Derivative time adjusting factor [heat-side]		1.00		7-151
<i>PcAJ</i>	Proportional band adjusting factor [cool-side]		1.00		7-150
<i>IcAJ</i>	Integral time adjusting factor [cool-side]		1.00		7-150

<sup>a</sup> Factory set value varies depending on the instrument specification.

Continued on the next page.

Continued from the previous page.

Symbol	Name	Data range	Factory set value	User set value	Page
<i>dCAJ</i>	Derivative time adjusting factor [cool-side]	0.01 to 10.00 times	1.00		7-151
<i>F53.</i>	Function block 53	This is first parameter symbol of Function block 53.			
<i>ydb</i>	Open/Close output neutral zone	0.1 to 10.0 % of output	2.0		7-152
<i>yHS</i>	Open/Close output differential gap	0.1 to 5.0 % of output	1.0		7-153
<i>ybr</i>	Action at feedback resistance (FBR) input error	0: Action depending on the valve action at STOP 1: Control action continued	0		7-153
<i>Pos</i>	Feedback adjustment	At the Adjustment preparation screen, press the shift key for 5 seconds to start the adjustment.	—		7-154
<i>nof</i>	Control motor time	5 to 1000 seconds	10		7-155
<i>oLR</i>	Integrated output limiter	0.0 to 200.0 % of control motor time 0.0: Integrated output limiter function OFF This value becomes invalid when Feedback resistance (FBR) input is used.	150.0		7-155
<i>VAL</i>	Valve action at STOP	0: Close-side output OFF, Open-side output OFF 1: Close-side output ON, Open-side output OFF 2: Close-side output OFF, Open-side output ON	0		7-156
<i>YASo</i>	Action at saturated output	0: Invalid 1: Valid	0		7-156
<i>F54.</i>	Function block 54	This is first parameter symbol of Function block 54.			
<i>SFS</i>	ST start condition	0: Activate the Startup tuning (ST) function when the power is turned on; when transferred from STOP to RUN; or when the Set value (SV) is changed. 1: Activate the Startup tuning (ST) function when the power is turned on; or when transferred from STOP to RUN. 2: Activate the Startup tuning (ST) function when the Set value (SV) is changed.	0		7-157
<i>SFPE</i>	ST proportional band adjusting factor	0.01 to 10.00 times	1.00		7-157
<i>SFIE</i>	ST integral time adjusting factor		1.00		7-158
<i>SFDE</i>	ST derivative time adjusting factor		1.00		7-158
<i>F55.</i>	Function block 55	This is first parameter symbol of Function block 55.			
<i>CHrG</i>	Automatic temperature rise group	0 to 16 (0: Automatic temperature rise function OFF)	0		7-159
<i>rSG</i>	RUN/STOP group	0 to 16 (0: RUN/STOP group function OFF)	0		7-160
<i>CHrd</i>	Automatic temperature rise dead time	0.1 to 1999.9 seconds	10.0		7-161
<i>CHrf</i>	Automatic temperature rise gradient data	0.1 to Input span/minutes	1.0		7-161
<i>F60.</i>	Function block 60	This is first parameter symbol of Function block 60.			
<i>CnPI</i>	Communication 1 protocol	0: RKC communication 1: Modbus 2: Intercontroller communication <sup>b</sup>	0 <sup>a</sup>		7-162

<sup>a</sup> Factory set value varies depending on the instrument specification.<sup>b</sup> Intercontroller communication is available only when one communication function is selected.

Continued on the next page.

Continued from the previous page.

Symbol	Name	Data range	Factory set value	User set value	Page
<i>C2P2</i>	Communication 2 protocol	0: RKC communication 1: Modbus 2: Intercontroller communication	2		7-162
<i>F70</i>	Function block 70	This is first parameter symbol of Function block 70.			
<i>SCR</i>	Setting change rate limiter unit time	1 to 3600 seconds	60		7-163
<i>SDP</i>	Soak time unit	0: 0 hours 00 minutes to 99 hours 59 minutes 1: 0 minutes 00 seconds to 199 minutes 59 seconds	1		7-163
<i>F71</i>	Function block 71	This is first parameter symbol of Function block 71.			
<i>SLH</i>	Setting limiter high	Setting limiter low to Input scale high [Varies with the setting of the Decimal point position]	Input scale high		7-164
<i>SLL</i>	Setting limiter low	Input scale low to Setting limiter high [Varies with the setting of the Decimal point position]	Input scale low		7-164
<i>F91</i>	Function block 91	This is first parameter symbol of Function block 91.			
<i>C492</i>	ROM version monitor	Display the version of loaded software.	—		7-165
<i>OT</i>	Integrated operating time monitor	0 to 19999 hours	—		7-165
<i>TCU</i>	Holding peak value ambient temperature monitor	-10.0 to +100.0 °C	—		7-165

**Table 1: Digital input (DI) assignment**





Code	Digital input 1 (DI1)	Digital input 2 (DI2)	Digital input 3 (DI3)	Digital input 4 (DI4)	Digital input 5 (DI5)
01	Unused	Unused	Unused	Unused	Unused
02	Memory area number selection (1 to 8)			Memory area set	RUN/STOP transfer
03	Memory area number selection (1 to 8)			Memory area set	Unused
04	Memory area number selection (1 to 8)			Memory area set	Auto/Manual transfer
05	Memory area number selection (1 to 8)			Memory area set	Interlock release
06	Memory area number selection (1 to 8)			RUN/STOP transfer	Unused
07	Memory area number selection (1 to 8)			RUN/STOP transfer	Auto/Manual transfer
08	Memory area number selection (1 to 8)			RUN/STOP transfer	Interlock release
09	Memory area number selection (1 to 8)			Unused	Auto/Manual transfer
10	Memory area number selection (1 to 8)			Unused	Interlock release
11	Memory area number selection (1 to 8)			Auto/Manual transfer	Interlock release
12	Memory area number selection (1 to 8)				
13	RUN/STOP transfer	Remote/Local transfer *	Auto/Manual transfer		
14	RUN/STOP transfer	Remote/Local transfer *	Interlock release		
15	RUN/STOP transfer	Auto/Manual transfer	Interlock release		
16	Remote/Local transfer *	Auto/Manual transfer	Interlock release		
17	RUN/STOP transfer	Remote/Local transfer *			
18	RUN/STOP transfer	Auto/Manual transfer			
19	RUN/STOP transfer	Interlock release			
20	Remote/Local transfer *	Auto/Manual transfer			
21	Remote/Local transfer *	Interlock release			
22	Auto/Manual transfer	Interlock release			
23	RUN/STOP transfer				
24	Remote/Local transfer *				
25	Auto/Manual transfer				
26	Interlock release				

\* In the case of the optional function A, C and D without remote setting input and communication, the Remote/Local transfer becomes invalid.

**Table 2: Output assignment**

This setting is conducted in engineering mode.

Code	Output 1 (OUT1)	Output 2 (OUT2)	Digital output 1 (DO1)	Digital output 2 (DO2)
01	Control output 1	Control output 2	Event output 1 (EV1)	Event output 2 (EV2)
02	Control output 1	Control output 2	Event output 1 (EV1)	Event output 4 (EV4)
03	Control output 1	Control output 2	Event output 1 (EV1)	Heater break alarm (HBA) output
04	Control output 1	Control output 2	Event output 1 (EV1)	FAIL output (De-energized)
05	Control output 1	Control output 2	Event output 4 (EV4)	Heater break alarm (HBA) output
06	Control output 1	Control output 2	Event output 4 (EV4)	FAIL output (De-energized)
07	Control output 1	Control output 2	Heater break alarm (HBA) output	FAIL output (De-energized)
08	Control output 1	Heater break alarm (HBA) output	Event output 1 (EV1)	Event output 2 (EV2)
09	Control output 1	Heater break alarm (HBA) output	Event output 1 (EV1)	Event output 4 (EV4)
10	Control output 1	Heater break alarm (HBA) output	Event output 1 (EV1)	FAIL output (De-energized)
11	Control output 1	Heater break alarm (HBA) output	Event output 4 (EV4)	FAIL output (De-energized)
12	Control output 1	FAIL output (De-energized)	Event output 1 (EV1)	Event output 2 (EV2)
13	Control output 1	FAIL output (De-energized)	Event output 1 (EV1)	Event output 4 (EV4)
14	Control output 1	Event output 1 (EV1)	Event output 2 (EV2)	Event output 3 (EV3)
15	Control output 1	Event output 4 (EV4)	Event output 1 (EV1)	Event output 2 (EV2)

-  Heater break alarm (HBA) output becomes *OR* when two Current transformer (CT) inputs are available.
-  Energized/De-energized is configurable except for the FAIL output.  
(Factory shipment: Energized)
-  When used as Heat/Cool PID control, select any code of 1 to 7.
-  For Position proportioning PID control, regardless of the above selection, OUT1 becomes the open-side output, and OUT2 becomes the close-side output.
-  Outputs and Event functions not specified in the model code is not valid if specified.





# INDEX

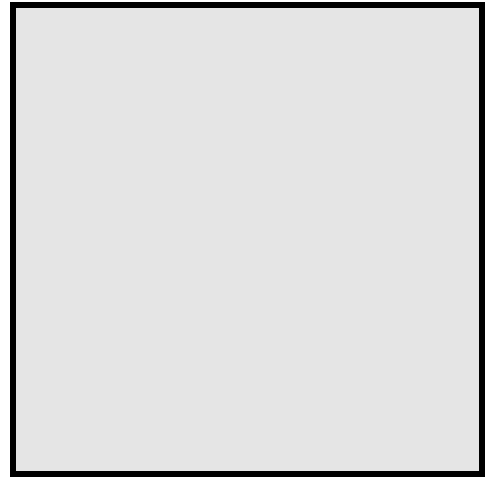

Alphabetical Order .....	B-2
Character Order.....	B-5

# Alphabetical Order

## A

Action (high) at input error ..... 7-55, 7-131  
 Action (low) at input error ..... 7-55, 7-131  
 Action at feedback resistance (FBR) input error  
 ..... 6-49, 7-56, 7-153  
 Action at saturated output ..... 7-56, 7-156  
 Alarm (ALM) lamp lighting condition 1 ..... 7-53, 7-84  
 Alarm (ALM) lamp lighting condition 2 ..... 7-53, 7-84  
 Area soak time ..... 7-23, 7-35  
 AT bias ..... 7-56, 7-140  
 AT cycles ..... 7-56, 7-141  
 AT differential gap time ..... 7-56, 7-142  
 Auto/Manual transfer ..... 6-23, 7-14, 7-18  
 Automatic temperature rise dead time ..... 7-57, 7-161  
 Automatic temperature rise gradient data ..... 7-57, 7-161  
 Automatic temperature rise group ..... 7-57, 7-159  
 Automatic temperature rise learning ..... 6-72, 7-14, 7-17

## B

Bar graph display ..... 7-52, 7-66  
 Bar graph display resolution ..... 7-52, 7-68  
 Burnout direction ..... 7-53, 7-77

## C

Cascade control function ..... 6-61, 6-81  
 Communication 1 protocol ..... 7-57, 7-162  
 Communication 2 protocol ..... 7-57, 7-162  
 Communication speed 1 ..... 7-37, 7-48  
 Communication speed 2 ..... 7-37, 7-48  
 Control action ..... 7-55, 7-125  
 Control area Local (LOC)/External (EXT) transfer  
 ..... 6-38, 7-14, 7-20  
 Control loop break alarm (LBA) time ..... 7-23, 7-25  
 Control motor time ..... 6-49, 7-56, 7-153  
 Control response parameter ..... 7-23, 7-29  
 CT1 assignment ..... 7-55, 7-113  
 CT1 ratio ..... 7-55, 7-112  
 CT2 assignment ..... 7-55, 7-117  
 CT2 ratio ..... 7-55, 7-116  
 Current transformer 1 (CT1) input value monitor  
 ..... 7-2, 7-3, 7-7  
 Current transformer 2 (CT2) input value monitor  
 ..... 7-2, 7-3, 7-7

## D

Data bit configuration 1 ..... 7-37, 7-49  
 Data bit configuration 2 ..... 7-37, 7-49  
 Decimal point position ..... 7-53, 7-73  
 Derivative action ..... 7-55, 7-136  
 Derivative gain ..... 7-55, 7-129  
 Derivative time [cool-side] ..... 7-23, 7-31  
 Derivative time [heat-side] ..... 7-23, 7-28  
 Derivative time adjusting factor [cool-side] ..... 7-56, 7-151  
 Derivative time adjusting factor [heat-side] ..... 7-56, 7-151

Derivative time limiter (high) [cool-side] ..... 7-56, 7-149  
 Derivative time limiter (high) [heat-side] ..... 7-56, 7-146  
 Derivative time limiter (low) [cool-side] ..... 7-56, 7-149  
 Derivative time limiter (low) [heat-side] ..... 7-56, 7-146  
 Device address 1 ..... 7-37, 7-47  
 Device address 2 ..... 7-37, 7-47  
 Digital input (DI) assignment ..... 7-53, 7-80  
 Direct key type ..... 7-52, 7-70  
 Direct key selection ..... 7-52, 7-70  
 Display unit ..... 7-53, 7-73

## E

Energized/De-energized ..... 7-53, 7-83  
 Event 1 delay timer ..... 7-54, 7-94  
 Event 1 differential gap ..... 7-54, 7-93  
 Event 1 hold action ..... 7-54, 7-90  
 Event 1 interlock ..... 7-54, 7-92  
 Event 1 set value (EV1) ..... 7-23, 7-24  
 Event 1 type ..... 7-54, 7-88  
 Event 2 delay timer ..... 7-54, 7-100  
 Event 2 differential gap ..... 7-54, 7-99  
 Event 2 hold action ..... 7-54, 7-98  
 Event 2 interlock ..... 7-54, 7-99  
 Event 2 set value (EV2) ..... 7-23, 7-24  
 Event 2 type ..... 7-54, 7-97  
 Event 3 delay timer ..... 7-54, 7-104  
 Event 3 differential gap ..... 7-54, 7-103  
 Event 3 hold action ..... 7-54, 7-102  
 Event 3 interlock ..... 7-54, 7-103  
 Event 3 set value (EV3) ..... 7-23, 7-24  
 Event 3 type ..... 7-54, 7-101  
 Event 4 delay timer ..... 7-54, 7-110  
 Event 4 differential gap ..... 7-54, 7-109  
 Event 4 hold action ..... 7-54, 7-107  
 Event 4 interlock ..... 7-54, 7-108  
 Event 4 set value (EV4) ..... 7-23, 7-24  
 Event 4 type ..... 7-54, 7-105  
 Event monitor 1 ..... 7-2, 7-3, 7-8  
 Event monitor 2 ..... 7-2, 7-3, 7-8  
 External input type ..... 7-55, 7-121

## F

Feedback adjustment ..... 6-50, 7-56, 7-154  
 Force ON of Event 1 action ..... 7-54, 7-96  
 Force ON of Event 2 action ..... 7-54, 7-100  
 Force ON of Event 3 action ..... 7-54, 7-104  
 Force ON of Event 4 action ..... 7-54, 7-111

## G

Group RUN/STOP function ..... 6-61, 6-64

## H

Heat/Cool PID control ..... 6-15, 6-18, 7-126

Heater break alarm 1 (HBA1) set value ..... 7-37, 7-38  
 Heater break alarm 1 (HBA1) type ..... 7-55, 7-114  
 Heater break alarm 2 (HBA2) set value ..... 7-37, 7-38  
 Heater break alarm 2 (HBA2) type ..... 7-55, 7-118  
 Heater break determination point 1 ..... 7-37, 7-41  
 Heater break determination point 2 ..... 7-37, 7-41  
 Heater melting determination point 1 ..... 7-37, 7-42  
 Heater melting determination point 2 ..... 7-37, 7-42  
 Hold action ..... 7-90  
 Holding peak value ambient temperature monitor  
 ..... 7-57, 7-165  
 Hot/Cold start ..... 7-55, 7-119

**I**

Input error determination point (high) ..... 7-53, 7-76  
 Input error determination point (low) ..... 7-53, 7-76  
 Input scale high ..... 7-53, 7-74  
 Input scale low ..... 7-53, 7-74  
 Input type ..... 7-53, 7-71  
 Integral time [cool-side] ..... 7-23, 7-30  
 Integral time [heat-side] ..... 7-23, 7-28  
 Integral time adjusting factor [cool-side] ..... 7-56, 7-150  
 Integral time adjusting factor [heat-side] ..... 7-56, 7-150  
 Integral time limiter (high) [cool-side] ..... 7-56, 7-148  
 Integral time limiter (high) [heat-side] ..... 7-56, 7-145  
 Integral time limiter (low) [cool-side] ..... 7-56, 7-148  
 Integral time limiter (low) [heat-side] ..... 7-56, 7-145  
 Integral/derivative time decimal point position .... 7-55, 7-129  
 Integrated operating time monitor ..... 7-57, 7-165  
 Integrated output limiter ..... 7-56, 7-155  
 Interlock release ..... 6-39, 7-2, 7-3, 7-13  
 Interval time 1 ..... 7-37, 7-50  
 Interval time 2 ..... 7-37, 7-50

**L**

LBA deadband ..... 7-23, 7-26  
 Link area number ..... 7-23, 7-36  
 Loader communication connector ..... 1-10  
 Loader communication ..... 1-15

**M**

Manipulated output value (MV1) at STOP mode ..... 7-55, 7-132  
 Manipulated output value (MV1) monitor [heat-side]  
 ..... 7-2, 7-3, 7-9  
 Manipulated output value (MV2) at STOP mode ..... 7-55, 7-132  
 Manipulated output value (MV2) monitor [cool-side]  
 ..... 7-2, 7-3, 7-10  
 Manipulated output value at input error ..... 7-55, 7-132  
 Manipulated output value at MV transfer ..... 7-2, 7-3, 7-11  
 Manual reset ..... 7-23, 7-33  
 Master channel selection ..... 7-55, 7-122  
 Measured value (PV)/Set value (SV) monitor ..... 7-2, 7-3, 7-5  
 Memory area soak time monitor ..... 7-2, 7-3, 7-10

Memory area transfer ..... 6-33, 7-2, 7-3, 7-11  
 MV transfer function ..... 7-55, 7-124

**N**

Number of heater break alarm 1 (HBA1) delay times  
 ..... 7-55, 7-115  
 Number of heater break alarm 2 (HBA2) delay times  
 ..... 7-55, 7-118

**O**

ON/OFF action differential gap (lower) ..... 7-55, 7-130  
 ON/OFF action differential gap (upper) ..... 7-55, 7-130  
 Open/Close output differential gap ..... 6-49, 7-56, 7-153  
 Open/Close output neutral zone ..... 6-49, 7-56, 7-152  
 Output assignment ..... 7-53, 7-82  
 Output change rate limiter (down) [MV1] ..... 7-55, 7-133  
 Output change rate limiter (down) [MV2] ..... 7-55, 7-133  
 Output change rate limiter (up) [MV1] ..... 7-55, 7-133  
 Output change rate limiter (up) [MV2] ..... 7-55, 7-133  
 Output limiter high (MV1) ..... 7-55, 7-135  
 Output limiter high (MV2) ..... 7-55, 7-135  
 Output limiter low (MV1) ..... 7-55, 7-135  
 Output limiter low (MV2) ..... 7-55, 7-135  
 Output status at STOP mode ..... 7-53, 7-85  
 Output value with AT turned off ..... 7-56, 7-143  
 Output value with AT turned on ..... 7-56, 7-143  
 Overlap/Deadband ..... 7-23, 7-32  
 Overlap/Deadband reference point ..... 7-55, 7-138

**P**

PID/AT transfer ..... 6-15, 7-14, 7-15  
 PID control ..... 6-15, 6-19, 6-73  
 Position proportioning control ..... 4-7, 6-43, 7-152  
 Power supply frequency ..... 7-53, 7-78  
 Proportional band [cool-side] ..... 7-23, 7-30  
 Proportional band [heat-side] ..... 7-23, 7-27  
 Proportional band adjusting factor [cool-side] ..... 7-56, 7-150  
 Proportional band adjusting factor [heat-side] ..... 7-56, 7-150  
 Proportional band limiter (high) [cool-side] ..... 7-56, 7-147  
 Proportional band limiter (high) [heat-side] ..... 7-56, 7-144  
 Proportional band limiter (low) [cool-side] ..... 7-56, 7-147  
 Proportional band limiter (low) [heat-side] ..... 7-56, 7-144  
 Proportional cycle time [cool-side] ..... 7-37, 7-46  
 Proportional cycle time [heat-side] ..... 7-37, 7-46  
 PV bias ..... 7-37, 7-43  
 PV digital filter ..... 7-37, 7-43  
 PV flashing display at input error ..... 7-52, 7-69  
 PV low input cut-off ..... 7-37, 7-44  
 PV ratio ..... 7-37, 7-43  
 PV transfer function ..... 7-55, 7-124

**R**

Ratio setting function ..... 6-89

---

Re-hold action .....	7-91
Remote setting (RS) input value monitor .....	7-2, 7-3, 7-7
Remote setting input type .....	7-53, 7-79
Remote/Local transfer .....	6-29, 7-14, 7-19
ROM version monitor .....	7-57, 7-165
RS bias .....	7-37, 7-45
RS digital filter .....	7-37, 7-45
RS ratio .....	7-37, 7-45
RUN/STOP group .....	7-57, 7-160
RUN/STOP transfer .....	6-11, 7-14, 7-21

**S**

Sampling cycle .....	7-53, 7-78
Set lock level .....	5-11, 7-37, 7-51
Set value (SV) .....	7-2, 7-3, 7-7
Setting change rate limiter (down) .....	7-23, 7-34
Setting change rate limiter (up) .....	7-23, 7-34
Setting change rate limiter unit time .....	7-57, 7-163
Setting limiter high .....	7-57, 7-164
Setting limiter low .....	7-57, 7-164
Soak time unit .....	7-57, 7-163
Square root extraction .....	7-53, 7-77
ST derivative time adjusting factor .....	7-56, 7-158
ST integral time adjusting factor .....	7-56, 7-158
ST proportional band adjusting factor .....	7-55, 7-157
ST start condition .....	7-56, 7-157
Start determination point .....	7-55, 7-120
Startup tuning (ST) .....	6-18, 7-14, 7-16
STOP display .....	7-52, 7-65
SV tracking .....	7-55, 7-123

**T**

Timer 1 .....	7-53, 7-83
Timer 2 .....	7-53, 7-83
Timer 3 .....	7-53, 7-83
Timer 4 .....	7-53, 7-83
Transmission output scale high .....	7-53, 7-87
Transmission output scale low .....	7-53, 7-87
Transmission output type .....	7-53, 7-86

**U**

Undershoot suppression factor .....	7-55, 7-137
-------------------------------------	-------------

**V**

Valve action at STOP .....	6-50, 7-56, 7-156
----------------------------	-------------------

# Character Order

\* Mode

MONI: SV setting &amp; Monitor mode

SETUP: Setup Setting mode

OPE: Operation mode

ENG: Engineering mode

PARA: Parameter Setting mode

Symbol	Name	Mode *	Page
<b>A (A)</b>			
<i>Add1</i>	Add1 Device address 1	SETUP	7-37, 7-47
<i>Add2</i>	Add2 Device address 2	SETUP	7-37, 7-47
<i>AHS</i>	AHS Transmission output scale high	ENG (F33)	7-53, 7-87
<i>ALC1</i>	ALC1 Alarm (ALM) lamp lighting condition 1	ENG (F30)	7-53, 7-84
<i>ALC2</i>	ALC2 Alarm (ALM) lamp lighting condition 2	ENG (F30)	7-53, 7-84
<i>ALS</i>	ALS Transmission output scale low	ENG (F33)	7-53, 7-87
<i>A-n</i>	A-M Auto/Manual transfer	OPE	6-23, 7-14, 7-18
<i>Ao</i>	Ao Transmission output type	ENG (F33)	7-53, 7-86
<i>AoVE</i>	AoVE Action (high) at input error	ENG (F51)	7-55, 7-131
<i>APF</i>	APF Memory area soak time monitor	MONI	7-2, 7-3, 7-10
<i>ArE</i>	ArE Memory area transfer	MONI	6-33, 7-2, 7-3, 7-11
<i>AST</i>	AST Area soak time	PARA	7-23, 7-35
<i>ATb</i>	ATb AT bias	ENG (F52)	7-56, 7-140
<i>ATC</i>	ATC AT cycles	ENG (F52)	7-56, 7-141
<i>ATH</i>	ATH AT differential gap time	ENG (F52)	7-56, 7-142
<i>AToF</i>	AToF Output value with AT turned off	ENG (F52)	7-56, 7-143
<i>ATon</i>	ATon Output value with AT turned on	ENG (F52)	7-56, 7-143
<i>ATU</i>	ATU PID/AT transfer	OPE	6-15, 7-14, 7-15
<i>AUnE</i>	AUnE Action (low) at input error	ENG (F51)	7-55, 7-131
<b>B (b) (b)</b>			
<i>bit1</i>	bit1 Data bit configuration 1	SETUP	7-37, 7-49
<i>bit2</i>	bit2 Data bit configuration 2	SETUP	7-37, 7-49
<i>boS</i>	boS Burnout direction	ENG (F21)	7-53, 7-77
<i>bPS1</i>	bPS1 Communication speed 1	SETUP	7-37, 7-48
<i>bPS2</i>	bPS2 Communication speed 2	SETUP	7-37, 7-48
<b>C (C)</b>			
<i>CAM</i>	CAM External input type	ENG (F50)	7-55, 7-121
<i>Chr</i>	Chr Automatic temperature rise learning	OPE	6-72, 7-14, 7-17
<i>CHrd</i>	CHrd Automatic temperature rise dead time	ENG (F55)	7-57, 7-161
<i>CHrG</i>	CHrG Automatic temperature rise group	ENG (F55)	7-57, 7-159
<i>CHrT</i>	CHrT Automatic temperature rise gradient data	ENG (F55)	7-57, 7-161
<i>CMP1</i>	CMP1 Communication 1 protocol	ENG (F60)	7-57, 7-162
<i>CMP2</i>	CMP2 Communication 2 protocol	ENG (F60)	7-57, 7-162
<i>CT1</i>	CT1 Current transformer 1 (CT1) input value monitor	MONI	7-2, 7-3, 7-7
<i>CT2</i>	CT2 Current transformer 2 (CT2) input value monitor	MONI	7-2, 7-3, 7-7
<i>CTA1</i>	CTA1 CT1 assignment	ENG (F45)	7-55, 7-113
<i>CTA2</i>	CTA2 CT2 assignment	ENG (F46)	7-55, 7-117
<i>CTr1</i>	CTr1 CT1 ratio	ENG (F45)	7-55, 7-112
<i>CTr2</i>	CTr2 CT2 ratio	ENG (F46)	7-55, 7-116

Symbol	Name	Mode *	Page
<b>D (d) (d)</b>			
<i>d</i>	d Derivative time [heat-side]	PARA	7-23, 7-28
<i>dAJ</i>	dAJ Derivative time adjusting factor [heat-side]	ENG (F52)	7-56, 7-149
<i>db</i>	db Overlap/Deadband	PARA	7-23, 7-32
<i>dbPR</i>	dbPA Overlap/Deadband reference point	ENG (F51)	7-55, 7-138
<i>dc</i>	dc Derivative time [cool-side]	PARA	7-23, 7-31
<i>dcAJ</i>	dcAJ Derivative time adjusting factor [cool-side]	ENG (F52)	7-56, 7-151
<i>dcLH</i>	dcLH Derivative time limiter (high) [cool-side]	ENG (F52)	7-56, 7-149
<i>dcLL</i>	dcLL Derivative time limiter (low) [cool-side]	ENG (F52)	7-56, 7-149
<i>dE</i>	dE Bar graph display	ENG (F10)	7-52, 7-66
<i>dEUT</i>	dEUT Bar graph display resolution	ENG (F10)	7-52, 7-68
<i>dF</i>	dF PV digital filter	SETUP	7-37, 7-43
<i>dF2</i>	dF2 RS digital filter	SETUP	7-37, 7-45
<i>dGA</i>	dGA Derivative gain	ENG (F51)	7-55, 7-129
<i>dSL</i>	dSL Digital input (DI) assignment	ENG (F23)	7-53, 7-80
<i>dLH</i>	dLH Derivative time limiter (high) [heat-side]	ENG (F52)	7-56, 7-146
<i>dLL</i>	dLL Derivative time limiter (low) [heat-side]	ENG (F52)	7-56, 7-146
<i>dSoP</i>	dSoP PV flashing display at input error	ENG (F10)	7-52, 7-69
<i>dTP</i>	dTP Derivative action	ENG (F51)	7-55, 7-136
<b>E (E)</b>			
<i>EEo1</i>	EEo1 Force ON of Event 1 action	ENG (F41)	7-54, 7-96
<i>EEo2</i>	EEo2 Force ON of Event 2 action	ENG (F42)	7-54, 7-100
<i>EEo3</i>	EEo3 Force ON of Event 3 action	ENG (F43)	7-54, 7-104
<i>EEo4</i>	EEo4 Force ON of Event 4 action	ENG (F44)	7-54, 7-111
<i>EH1</i>	EH1 Event 1 differential gap	ENG (F41)	7-54, 7-93
<i>EH2</i>	EH2 Event 2 differential gap	ENG (F42)	7-54, 7-99
<i>EH3</i>	EH3 Event 3 differential gap	ENG (F43)	7-54, 7-103
<i>EH4</i>	EH4 Event 4 differential gap	ENG (F44)	7-54, 7-109
<i>EHo1</i>	EHo1 Event 1 hold action	ENG (F41)	7-54, 7-90
<i>EHo2</i>	EHo2 Event 2 hold action	ENG (F42)	7-54, 7-98
<i>EHo3</i>	EHo3 Event 3 hold action	ENG (F43)	7-54, 7-102
<i>EHo4</i>	EHo4 Event 4 hold action	ENG (F44)	7-54, 7-107
<i>EIL1</i>	EIL1 Event 1 interlock	ENG (F41)	7-54, 7-92
<i>EIL2</i>	EIL2 Event 2 interlock	ENG (F42)	7-54, 7-99
<i>EIL3</i>	EIL3 Event 3 interlock	ENG (F43)	7-54, 7-103
<i>EIL4</i>	EIL4 Event 4 interlock	ENG (F44)	7-54, 7-108
<i>ES1</i>	ES1 Event 1 type	ENG (F41)	7-54, 7-88
<i>ES2</i>	ES2 Event 2 type	ENG (F42)	7-54, 7-97
<i>ES3</i>	ES3 Event 3 type	ENG (F43)	7-54, 7-101
<i>ES4</i>	ES4 Event 4 type	ENG (F44)	7-54, 7-105

Symbol	Name	Mode *	Page
<i>E</i> <i>H</i> <i>1</i>	EV1 Event 1 set value (EV1)	PARA	7-23, 7-24
<i>E</i> <i>H</i> <i>2</i>	EV2 Event 2 set value (EV2)	PARA	7-23, 7-24
<i>E</i> <i>H</i> <i>3</i>	EV3 Event 3 set value (EV3)	PARA	7-23, 7-24
<i>E</i> <i>H</i> <i>4</i>	EV4 Event 4 set value (EV4)	PARA	7-23, 7-24
<i>E</i> <i>H</i> <i>n</i> <i>1</i>	EVM1 Event monitor 1	MONI	7-2, 7-3, 7-8
<i>E</i> <i>H</i> <i>n</i> <i>2</i>	EVM2 Event monitor 2	MONI	7-2, 7-3, 7-8
<i>E</i> <i>H</i> <i>T</i> <i>1</i>	EVT1 Event 1 delay timer	ENG (F41)	7-54, 7-94
<i>E</i> <i>H</i> <i>T</i> <i>2</i>	EVT2 Event 2 delay timer	ENG (F42)	7-54, 7-100
<i>E</i> <i>H</i> <i>T</i> <i>3</i>	EVT3 Event 3 delay timer	ENG (F43)	7-54, 7-104
<i>E</i> <i>H</i> <i>T</i> <i>4</i>	EVT4 Event 4 delay timer	ENG (F44)	7-54, 7-110
<i>E</i> <i>Y</i> <i>C</i>	EXC Energized/De-energized	ENG (F30)	7-53, 7-83
<b>F (F)</b>			
<i>F</i> <i>n</i>	F <sub>n</sub> Direct key type	ENG (F11)	7-52, 7-70
<i>F</i> <i>n</i> <i>1</i>	F <sub>n1</sub> Direct key selection	ENG (F11)	7-52, 7-70
<b>H (H)</b>			
<i>H</i> <i>b</i> <i>A</i> <i>1</i>	HbA1 Heater break alarm 1 (HBA1) set value	SETUP	7-37, 7-38
<i>H</i> <i>b</i> <i>A</i> <i>2</i>	HbA2 Heater break alarm 2 (HBA2) set value	SETUP	7-37, 7-38
<i>H</i> <i>b</i> <i>C</i> <i>1</i>	HbC1 Number of heater break alarm 1 (HBA1) delay times	ENG (F45)	7-55, 7-115
<i>H</i> <i>b</i> <i>C</i> <i>2</i>	HbC2 Number of heater break alarm 2 (HBA2) delay times	ENG (F46)	7-55, 7-118
<i>H</i> <i>b</i> <i>H</i> <i>1</i>	HbH1 Heater melting determination point 1	SETUP	7-37, 7-42
<i>H</i> <i>b</i> <i>H</i> <i>2</i>	HbH2 Heater melting determination point 2	SETUP	7-37, 7-42
<i>H</i> <i>b</i> <i>L</i> <i>1</i>	HbL1 Heater break determination point 1	SETUP	7-37, 7-41
<i>H</i> <i>b</i> <i>L</i> <i>2</i>	HbL2 Heater break determination point 2	SETUP	7-37, 7-41
<i>H</i> <i>b</i> <i>S</i> <i>1</i>	HbS1 Heater break alarm 1 (HBA1) type	ENG (F45)	7-55, 7-113
<i>H</i> <i>b</i> <i>S</i> <i>2</i>	HbS2 Heater break alarm 2 (HBA2) type	ENG (F46)	7-55, 7-118
<b>I (I)</b>			
<i>I</i>	I Integral time [heat-side]	PARA	7-23, 7-28
<i>I</i> <i>A</i> <i>J</i>	IAJ Integral time adjusting factor [heat-side]	ENG (F52)	7-56, 7-150
<i>I</i> <i>c</i>	Ic Integral time [cool-side]	PARA	7-23, 7-30
<i>I</i> <i>c</i> <i>A</i> <i>J</i>	IcAJ Integral time adjusting factor [cool-side]	ENG (F52)	7-56, 7-150
<i>I</i> <i>c</i> <i>L</i> <i>H</i>	IcLH Integral time limiter (high) [cool-side]	ENG (F52)	7-56, 7-148
<i>I</i> <i>c</i> <i>L</i> <i>L</i>	IcLL Integral time limiter (low) [cool-side]	ENG (F52)	7-56, 7-148
<i>I</i> <i>d</i> <i>d</i> <i>P</i>	IddP Integral/derivative time decimal point position	ENG (F51)	7-55, 7-129
<i>I</i> <i>L</i> <i>H</i>	ILH Integral time limiter (high) [heat-side]	ENG (F52)	7-56, 7-145
<i>I</i> <i>L</i> <i>L</i>	ILL Integral time limiter (low) [heat-side]	ENG (F52)	7-56, 7-145
<i>I</i> <i>L</i> <i>r</i>	ILr Interlock release	MONI	6-39, 7-2, 7-3, 7-13
<i>I</i> <i>n</i> <i>P</i>	InP Input type	ENG (F21)	7-53, 7-71
<i>I</i> <i>n</i> <i>T</i> <i>1</i>	InT1 Interval time 1	SETUP	7-37, 7-50
<i>I</i> <i>n</i> <i>T</i> <i>2</i>	InT2 Interval time 2	SETUP	7-37, 7-50

Symbol	Name	Mode *	Page
<b>L (L)</b>			
<i>L</i> <i>b</i> <i>A</i>	LbA LbA Control loop break alarm (LBA) time	PARA	7-23, 7-25
<i>L</i> <i>b</i> <i>d</i>	Lbd LBA deadband	PARA	7-23, 7-26
<i>L</i> <i>C</i> <i>L</i>	LCK Set lock level	SETUP	5-11, 7-37, 7-51
<i>L</i> - <i>E</i>	L-E Control area Local (LOC)/External (EXT) transfer	OPE	6-38, 7-14, 7-20
<i>L</i> <i>n</i> <i>K</i> <i>A</i>	LnKA Link area number	PARA	7-23, 7-36
<i>L</i> <i>o</i> <i>G</i> <i>C</i>	LoGC Output assignment	ENG (F30)	7-53, 7-82
<b>M (n)</b>			
<i>n</i> <i>C</i> <i>H</i>	MCH Master channel selection	ENG (F50)	7-55, 7-122
<i>n</i> <i>o</i> <i>T</i>	MoT Control motor time	ENG (F53)	6-49, 7-56, 7-155
<i>n</i> <i>r</i>	Mr Manual reset	PARA	7-23, 7-33
<i>n</i> <i>H</i>	MV Manipulated output value (MV1) monitor [heat-side]	MONI	7-2, 7-3, 7-9
<i>n</i> <i>H</i> <i>2</i>	MV2 Manipulated output value (MV2) monitor [cool-side]	MONI	7-2, 7-3, 7-10
<i>n</i> <i>H</i> <i>T</i> <i>S</i>	MVTS MV transfer function	ENG (F50)	7-55, 7-124
<b>O (o) (a)</b>			
<i>o</i> <i>H</i> <i>H</i>	oHH ON/OFF action differential gap (upper)	ENG (F51)	7-55, 7-130
<i>o</i> <i>H</i> <i>L</i>	oHL ON/OFF action differential gap (lower)	ENG (F51)	7-55, 7-130
<i>o</i> <i>L</i> <i>A</i>	oLA Integrated output limiter	ENG (F53)	7-56, 7-155
<i>o</i> <i>L</i> <i>H</i>	oLH Output limiter high (MV1)	ENG (F51)	7-55, 7-135
<i>o</i> <i>L</i> <i>H</i> <i>2</i>	oLH2 Output limiter high (MV2)	ENG (F51)	7-55, 7-135
<i>o</i> <i>L</i> <i>L</i>	oLL Output limiter low (MV1)	ENG (F51)	7-55, 7-135
<i>o</i> <i>L</i> <i>L</i> <i>2</i>	oLL2 Output limiter low (MV2)	ENG (F51)	7-55, 7-135
<i>o</i> <i>r</i> <i>d</i>	ord Output change rate limiter (down) [MV1]	ENG (F51)	7-55, 7-133
<i>o</i> <i>r</i> <i>d</i> <i>2</i>	ord2 Output change rate limiter (down) [MV2]	ENG (F51)	7-55, 7-133
<i>o</i> <i>r</i> <i>U</i>	orU Output change rate limiter (up) [MV1]	ENG (F51)	7-55, 7-133
<i>o</i> <i>r</i> <i>U</i> <i>2</i>	orU2 Output change rate limiter (up) [MV2]	ENG (F51)	7-55, 7-133
<i>o</i> <i>S</i>	oS Control action	ENG (F51)	7-55, 7-125
<i>o</i> <i>T</i> <i>T</i> <i>1</i>	oTT1 Timer 1	ENG (F30)	7-53, 7-83
<i>o</i> <i>T</i> <i>T</i> <i>2</i>	oTT2 Timer 2	ENG (F30)	7-53, 7-83
<i>o</i> <i>T</i> <i>T</i> <i>3</i>	oTT3 Timer 3	ENG (F30)	7-53, 7-83
<i>o</i> <i>T</i> <i>T</i> <i>4</i>	oTT4 Timer 4	ENG (F30)	7-53, 7-83
<b>P (P)</b>			
<i>P</i>	P Proportional band [heat-side]	PARA	7-23, 7-27
<i>P</i> <i>A</i> <i>J</i>	PAJ Proportional band adjusting factor [heat-side]	ENG (F52)	7-56, 7-150
<i>P</i> <i>b</i>	Pb PV bias	SETUP	7-37, 7-43
<i>P</i> <i>c</i>	Pc Proportional band [cool-side]	PARA	7-23, 7-30
<i>P</i> <i>c</i> <i>A</i> <i>J</i>	PcAJ Proportional band adjusting factor [cool-side]	ENG (F52)	7-56, 7-150
<i>P</i> <i>c</i> <i>L</i> <i>H</i>	PcLH Proportional band limiter (high) [cool-side]	ENG (F52)	7-56, 7-147
<i>P</i> <i>c</i> <i>L</i> <i>L</i>	PcLL Proportional band limiter (low) [cool-side]	ENG (F52)	7-56, 7-147
<i>P</i> <i>d</i>	Pd Hot/Cold start	ENG (F50)	7-55, 7-119
<i>P</i> <i>d</i> <i>A</i>	PdA Start determination point	ENG (F50)	7-55, 7-120
<i>P</i> <i>F</i> <i>r</i> <i>q</i>	PFrq Power supply frequency	ENG (F21)	7-53, 7-78
<i>P</i> <i>G</i> <i>d</i> <i>P</i>	PGdP Decimal point position	ENG (F21)	7-53, 7-73

Symbol	Name	Mode *	Page
PGSH	PGSH Input scale high	ENG (F21)	7-53, 7-74
PGSL	PGSL Input scale low	ENG (F21)	7-53, 7-74
PLC	PLC PV low input cut-off	SETUP	7-37, 7-44
PLH	PLH Proportional band limiter (high) [heat-side]	ENG (F52)	7-56, 7-144
PLL	PLL Proportional band limiter (low) [heat-side]	ENG (F52)	7-56, 7-144
PoS	PoS Feedback adjustment	ENG (F53)	6-50, 7-56, 7-154
PoV	PoV Input error determination point (high)	ENG (F21)	7-53, 7-76
Pr	Pr PV ratio	SETUP	7-37, 7-43
PSn	PSn Manipulated output value at input error	ENG (F51)	7-55, 7-132
PSn'	PSn' Manipulated output value at MV transfer	MONI	7-2, 7-3, 7-11
PUn	PUn Input error determination point (low)	ENG (F21)	7-53, 7-76
PVTS	PVTS PV transfer function	ENG (F50)	7-55, 7-124
<b>R (r) (-)</b>			
rb	rb RS bias	SETUP	7-37, 7-45
rinP	rinP Remote setting input type	ENG (F22)	7-53, 7-79
r-L	r-L Remote/Local transfer	OPE	6-29, 7-14, 7-19
rMV1	rMV1 Manipulated output value (MV1) at STOP mode	ENG (F51)	7-55, 7-132
rMV2	rMV2 Manipulated output value (MV2) at STOP mode	ENG (F51)	7-55, 7-132
rPT	rPT Control response parameter	PARA	7-23, 7-29
rr	rr RS ratio	SETUP	7-37, 7-45
r-S	r-S RUN/STOP transfer	OPE	6-11, 7-14, 7-21
rSG	rSG RUN/STOP group	ENG (F55)	7-57, 7-160
<b>S (S)</b>			
SLH	SLH Setting limiter high	ENG (F71)	7-57, 7-164
SLL	SLL Setting limiter low	ENG (F71)	7-57, 7-164
SMP	SMP Sampling cycle	ENG (F21)	7-53, 7-78
SPCH	SPCH STOP display	ENG (F10)	7-52, 7-65
Sqr	Sqr Square root extraction	ENG (F21)	7-53, 7-77
SS	SS Output status at STOP mode	ENG (F30)	7-53, 7-85
STdK	STdK ST derivative time adjusting factor	ENG (F54)	7-56, 7-158
STdP	STdP Soak time unit	ENG (F70)	7-57, 7-163
STIK	STIK ST integral time adjusting factor	ENG (F54)	7-56, 7-158
STPK	STPK ST proportional band adjusting factor	ENG (F54)	7-56, 7-157
STS	STS ST start condition	ENG (F54)	7-56, 7-157
STU	STU Startup tuning (ST)	OPE	6-18, 7-14, 7-16
SV	SV Set value (SV)	MONI	7-2, 7-3, 7-7
SVr	SVr Remote setting (RS) input value monitor	MONI	7-2, 7-3, 7-7
SVrd	SVrd Setting change rate limiter (down)	PARA	7-23, 7-34
SVrT	SVrT Setting change rate limiter unit time	ENG (F70)	7-57, 7-163
SVrU	SVrU Setting change rate limiter (up)	PARA	7-23, 7-34

Symbol	Name	Mode *	Page
<b>T (t) (f, t)</b>			
t	t Proportional cycle time [cool-side]	SETUP	7-37, 7-46
f	f Proportional cycle time [heat-side]	SETUP	7-37, 7-46
TCJ	TCJ Holding peak value ambient temperature monitor	ENG (F91)	7-57, 7-165
Trk	Trk SV tracking	ENG (F50)	7-55, 7-123
<b>U (U)</b>			
Unit	Unit Display unit	ENG (F21)	7-53, 7-73
US	US Undershoot suppression factor	ENG (F51)	7-55, 7-137
<b>V (V)</b>			
VAL	VAL Valve action at STOP	ENG (F53)	6-50, 7-56, 7-156
<b>W (W)</b>			
WT	WT Integrated operating time monitor	ENG (F91)	7-57, 7-165
<b>Y (Y)</b>			
YASo	YASo Action at saturated output	ENG (F53)	7-56, 7-156
Ybr	Ybr Action at feedback resistance (FBR) input error	ENG (F53)	6-49, 7-56, 7-153
Ydb	Ydb Open/Close output neutral zone	ENG (F53)	6-49, 7-56, 7-152
YHS	YHS Open/Close output differential gap	ENG (F53)	6-49, 7-56, 7-153

# Revisions

Date of Revision	Manual Number	Reason for Revision
October, 2008	IMR01W16-E1	The first edition issue
August, 2009	IMR01W16-E2	<p>Addition of description:</p> <p>Optional function "J" P. 1-4, P. 1-7, P. 4-4, P. 4-18, P. 6-61, P. 7-81</p> <p>Direct action of Position proportioning PID control P. 1-4, P. 7-61, P. 7-125, P. A-19</p> <p>Overlap/Deadband reference point P. 7-55, P. 7-138, P. 9-9, P. A-20</p> <p>Action at saturated output P. 6-43, P. 6-44, P. 6-46, P. 6-49, P. 6-50, P. 7-56, P. 7-127, P. 7-156, P. 9-11, P. A-21</p> <p>Exception of key operation P. 5-2, P. 6-50, P. 7-57, P. 7-154</p> <p>Change of description:</p> <p>State of STOP mode P. 6-11</p> <p>Factory set value change:</p> <p>Heater break alarm 1 (HBA1) type P. 7-40, P. 7-113, P. 7-118, P. A-18</p>
	IMR01W16-E3	Intentionally unused (This version number is not used in English version to match the versions between Japanese and English versions.)
October, 2010	IMR01W16-E4	Revision for error corrections
July, 2012	IMR01W16-E5	<p>Updated for the latest version of the OS: P. 1-2, P. 1-15</p> <p>Added Communication tool PROTEM2: P. 1-15</p> <p>Corrected the closely mounting dimensions: P. 3-3</p> <p>Renamed the communication quick instruction manual: P. 4-14 to P.4-18</p> <p>Corrected the set value of Digital input (DI) assignment: P. 6-67</p> <p>Changed the data range of "Manipulated output value at MV transfer" in Heat/Cool PID control: P. 7-11, P. 9-9, P. A-9</p> <p>Added comment to Force ON of Event 4 action: P. 7-111</p> <p>Added comment to Decimal point position: P. 7-5, P. 7-7, P. 7-24, P. 7-26, P. 7-27, P. 7-32, P. 7-43, P. 7-45, P. 7-74, P.7-76, P. 7-87, P. 7-93, P. 7-103, P. 7-109, P. 7-120, P. 7-130, P. 7-140, P. 7-144, P. 7-147, P. 7-164, P. A-8 to P. A-12, P. A-15, P. A-16, P. A-20, P. A-22</p>
November, 2015	IMR01W16-E6	Change of compliance mark. (C-Tick → RCM) P. 9-17
October, 2016	IMR01W16-E7	<p>Added a new range code: P. 1-5</p> <p>Changed the address in the setting example of Master channel selection: P. 7-122</p> <p>Deleted unnecessary part: P. 9-12</p>







**RKC INSTRUMENT INC.**

HEADQUARTERS: 16-6, KUGAHARA 5-CHOME, OHTA-KU TOKYO 146-8515 JAPAN

PHONE: 03-3751-9799 (+81 3 3751 9799)

FAX: 03-3751-8585 (+81 3 3751 8585)

E-mail: [info@rkcinst.co.jp](mailto:info@rkcinst.co.jp)

Website: <http://www.rkcinst.com/>